

REVISIONS				
P.	LTM	DESCRIPTION	DATE	APVD
B1		REVISED PER ECO-15-001494	04FEB2015	AP DD

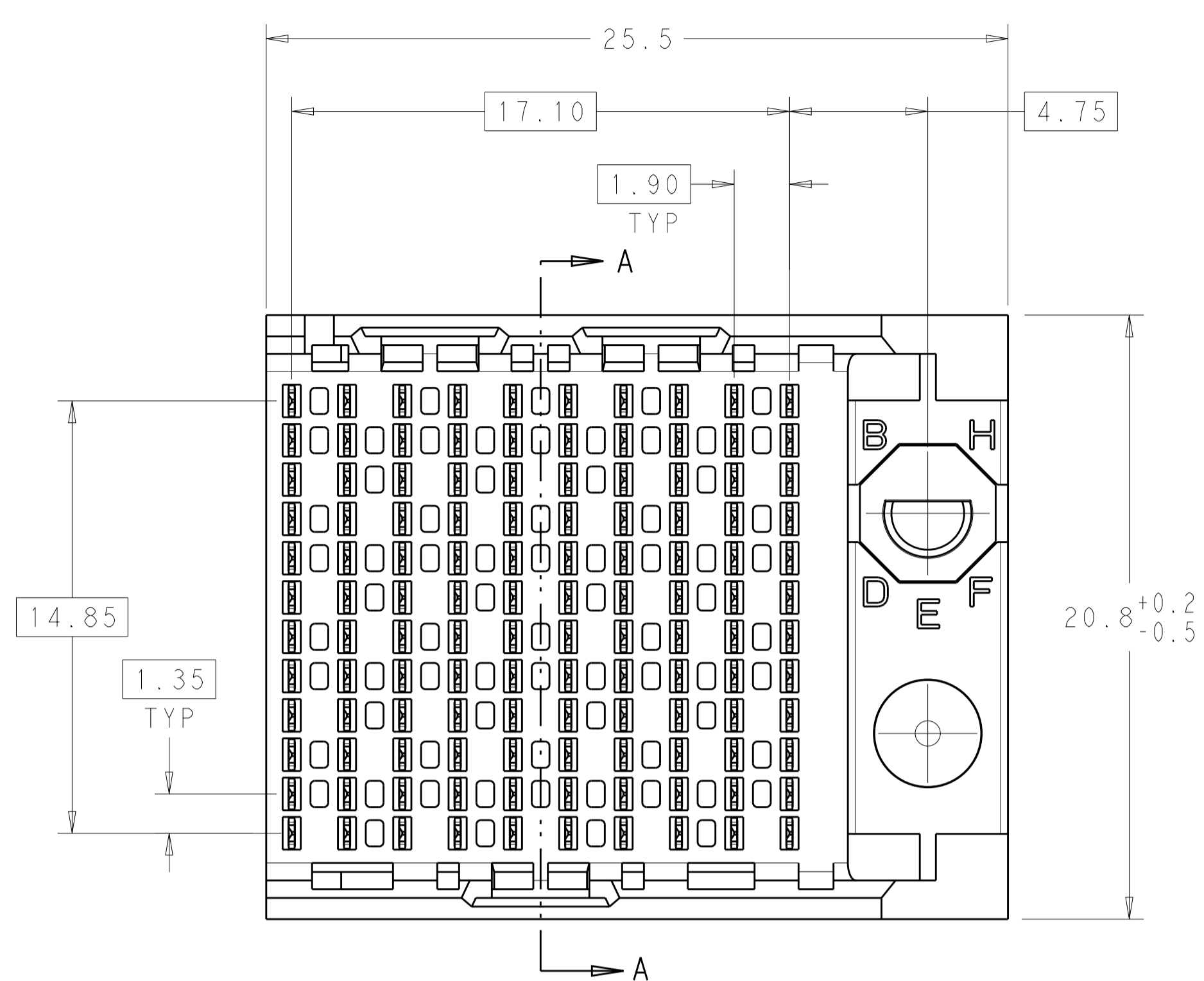

NOTCH DESIGNATES ROW A

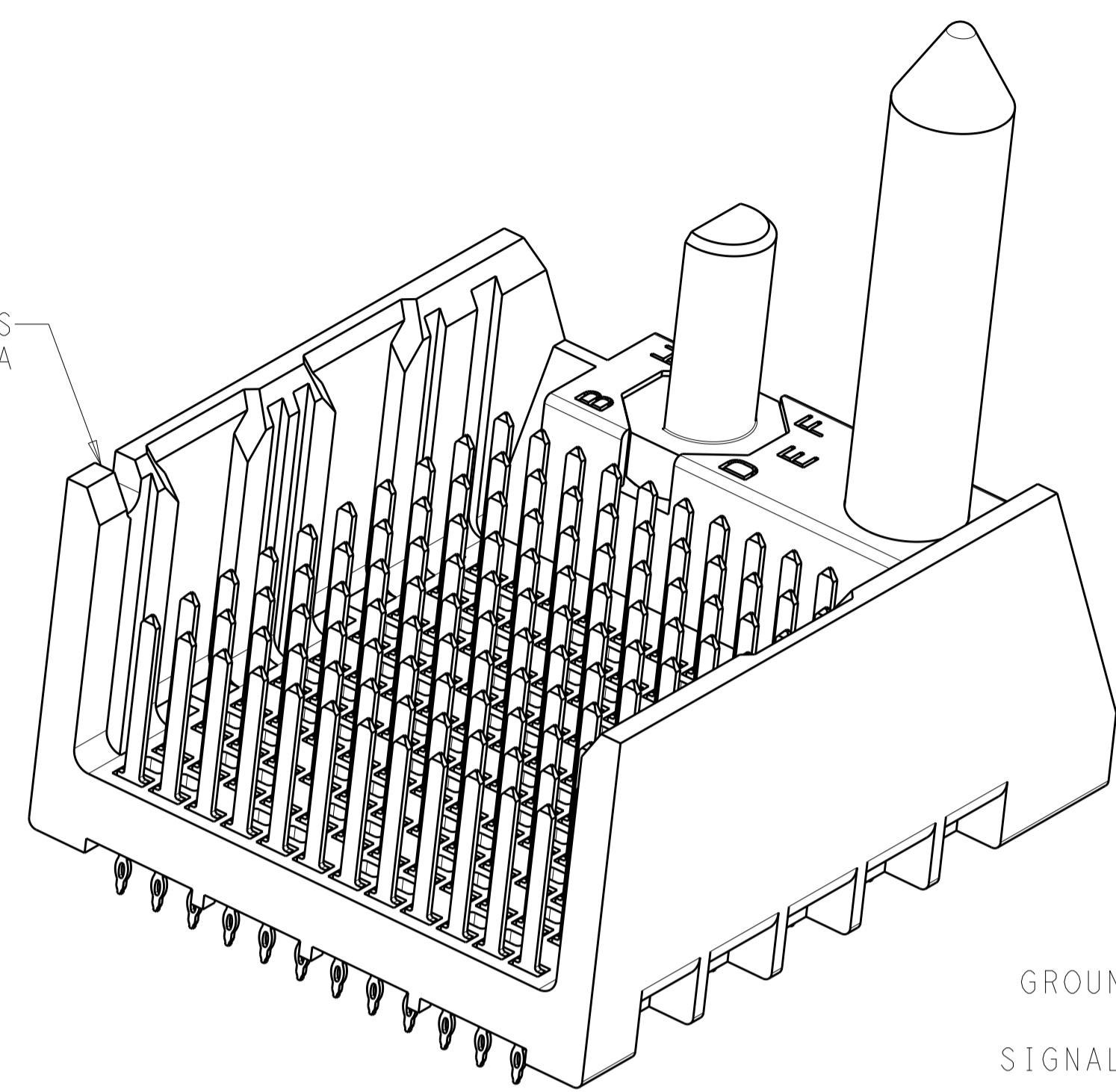

- △ MATERIAL:
HOUSING: LCP, GLASS FILLED, UL94V-0.
TERMINALS: HIGH PERFORMANCE COPPER ALLOY.
- △ FINISH:
30μ" MIN GOLD IN CONTACT AREA. SELECTIVE TIN ON PCB TAILS, NICKEL OVERALL.
- 3. SCREWS PACKAGED IN END OF PACKAGING TUBE.
- △ FOR GROUNDED GUIDE PIN USE $\varnothing 3.56 \pm 0.08$ PTH, $\varnothing 3.66$ DRILL, AND $\varnothing 6.5$ PAD.
- 5. KEYING PIN SHOWN IN POSITION A, SEE KEYING CHART ON SHEET 2 FOR OTHER POSITIONS.

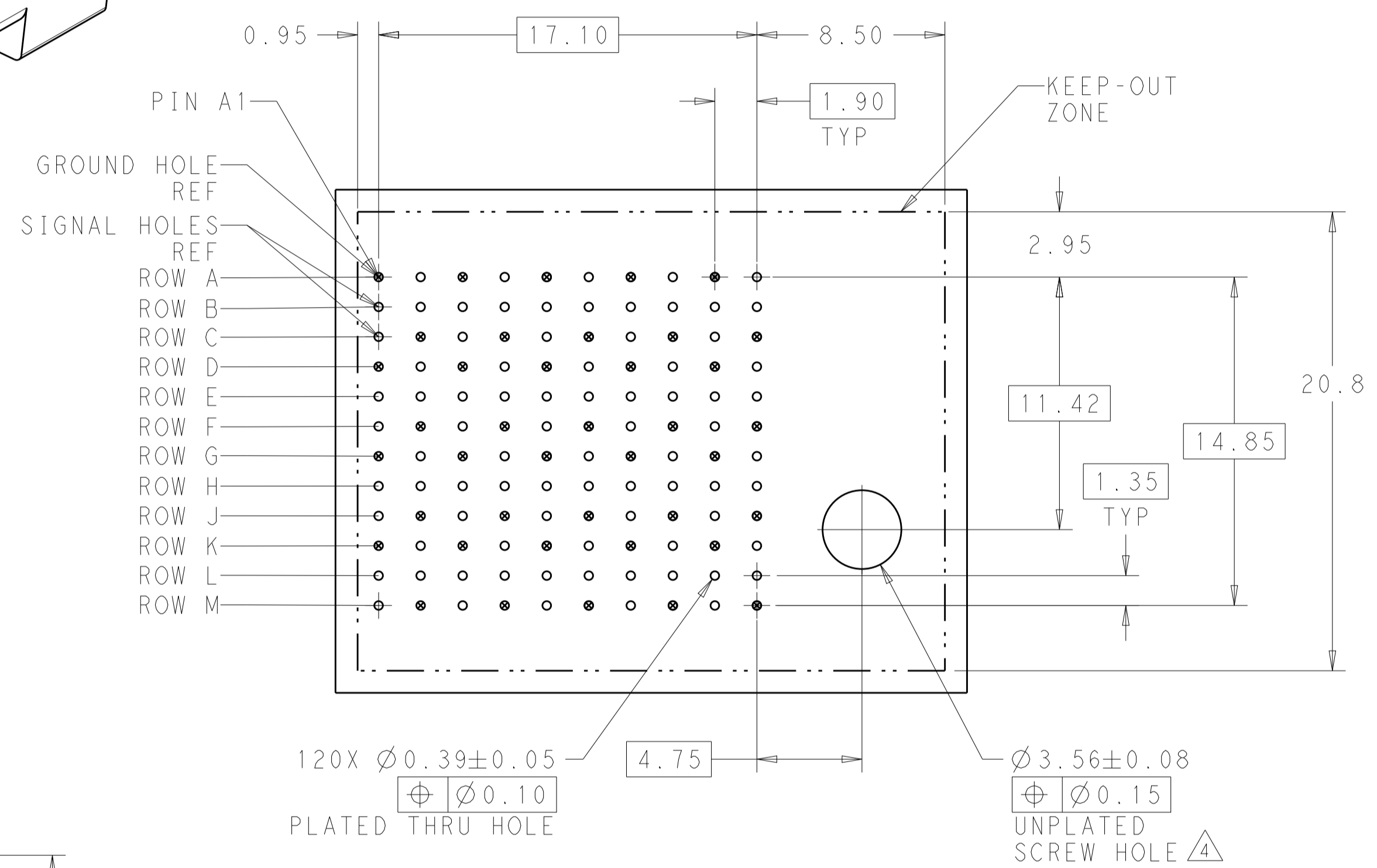



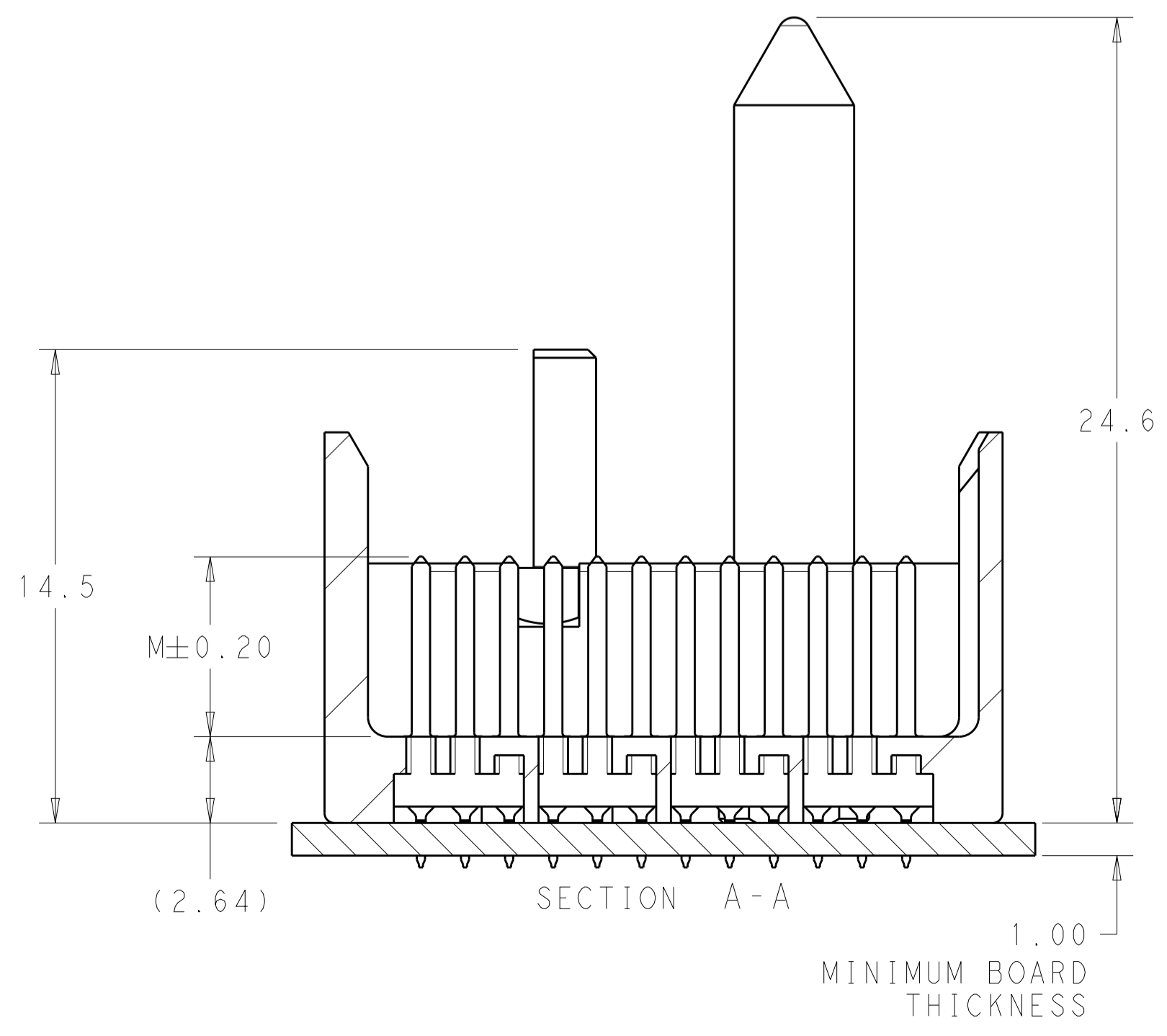
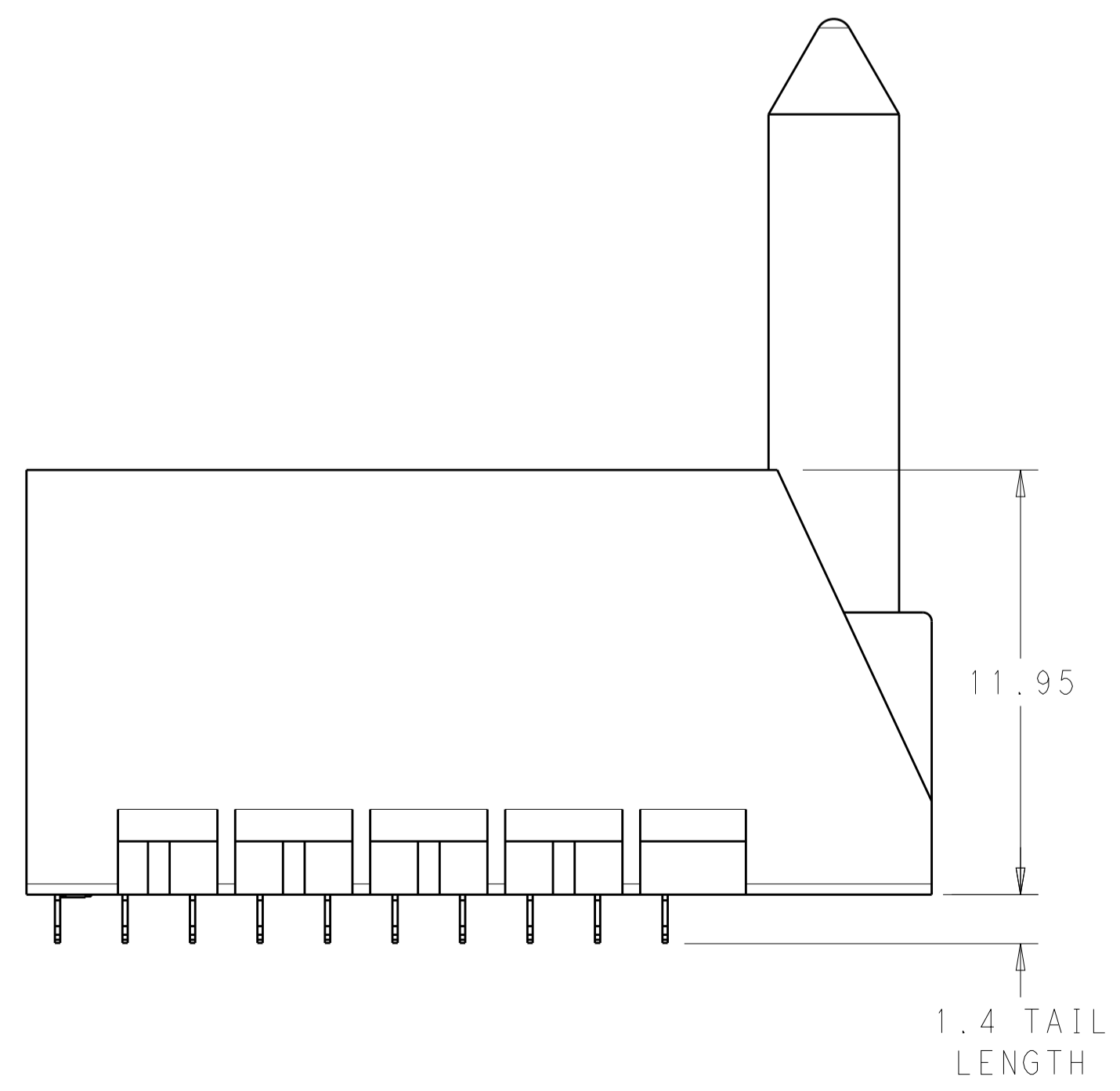























RIGHT GUIDED BACKPLANE HOLE PATTERN (CONNECTOR SIDE)



THIS DRAWING IS A CONTROLLED DOCUMENT.		OWN: J. K. SHOBER 26DECT11	TE Connectivity
DIMENSIONS: mm		CHK: J. EARY 26DECT11	
TOLERANCES UNLESS OTHERWISE SPECIFIED:		APVD: J. EARY 26DECT11	NAME: IMPACT, 4 PAIR, 10 COLUMN, HEADER PRODUCT SPEC: RIGHT GUIDED, OPEN END WALL APPLICATION SPEC: SIGNAL MODULE, 0.39 PTH
0 PLC ± 1 PLC ±0.25 2 PLC ±0.13 3 PLC ± 4 PLC ± ANGLES ±		SIZE: A1 CAGE CODE: 00779 DRAWING NO: C=2007813	
MATERIAL: SEE TABLE		WEIGHT: -	RESTRICTED TO: -
FINISH: SEE TABLE		CUSTOMER DRAWING	SCALE: 6:1 SHEET 1 OF 2 REV: B1

REVISIONS				
P.	LTN	DESCRIPTION	DATE	APVD
-	-	SEE SHEET 1	-	-



	H	5.5	8-2007813-3
	H	4.9	8-2007813-2
	H	4.5	8-2007813-1
	G	5.5	7-2007813-3
	G	4.9	7-2007813-2
	G	4.5	7-2007813-1
	F	5.5	6-2007813-3
	F	4.9	6-2007813-2
	F	4.5	6-2007813-1
	E	5.5	5-2007813-3
	E	4.9	5-2007813-2
	E	4.5	5-2007813-1
	D	5.5	4-2007813-3
	D	4.9	4-2007813-2
	D	4.5	4-2007813-1
	C	5.5	3-2007813-3
	C	4.9	3-2007813-2
	C	4.5	3-2007813-1
	B	5.5	2-2007813-3
	B	4.9	2-2007813-2
	B	4.5	2-2007813-1
	A	5.5	1-2007813-3
	A	4.9	1-2007813-2
	A	4.5	1-2007813-1
	-	5.5	2007813-3
	-	4.9	2007813-2
	-	4.5	2007813-1
FINISH	KEY POSITION	DIM M	PART NUMBER

REFER TO WWW.TE.COM
FOR PRODUCT AVAILABILITY

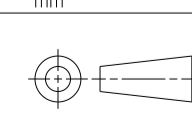
THIS DRAWING IS A CONTROLLED DOCUMENT.		DWN J. K. SHOBER 26DECT1 CHG J. EARY 26DECT1 APVD J. EARY 26DECT1	 TE Connectivity	NAME IMPACT, 4 PAIR, 10 COLUMN, HEADER RIGHT GUIDED, OPEN END WALL SIGNAL MODULE, 0.39 PTH
DIMENSIONS: mm 	TOLERANCES UNLESS OTHERWISE SPECIFIED: 0 PLC ±0.25 2 PLC ±0.13 3 PLC ±0.13 4 PLC ±0.13 ANGLES ±0.5°	PRODUCT SPEC - APPLICATION SPEC - WEIGHT - CUSTOMER DRAWING		
MATERIAL -		SEE TABLE	SCALE 5:1	SHEET 2 OF 2