



Features

- Balanced Mini-TRIGARD™ (5 mm diameter, 7.5 mm length)
- Ideal for board level protection of broadband circuits
- Symmetrical breakdown voltage (L-L, L-G)
- Leadless, surface mount for economical assembly
- High surge current rating, low insertion loss
- Stable breakdown throughout life
-  Recognized
- RoHS compliant* versions available

2038 Series Miniature Symmetrical 3-Electrode Surface Mount Gas Discharge Tube

Bourns offers a symmetrical surface mount (SM) 3-electrode GDT surge protection device. The industry-leading quality and features of the Bourns® miniature-TRIGARD™ series GDT continue in the 2038 symmetrical version. The 2038 series is ideal for board level protection of high bandwidth applications such as xDSL, cable broadband and high speed Ethernet, due to its symmetrical turn on characteristics as well as high energy-handling capability, long and stable life performance and low capacitance of less than 1 pF. The 2038 series breakdown voltages are nearly equal line to line as well as line to ground. Bourns® Gas Discharge Tubes (GDT) are designed to prevent damage from transient disturbances by acting as a “crowbar” in creating a virtual short-to-ground circuit during conduction. When an electrical surge exceeds the defined breakdown voltage level of the GDT, the gas becomes ionized and rapid conduction takes place. When the surge passes and the system voltage returns to normal levels, the GDT returns to its high-impedance (off) state.

Characteristics



Test Methods per ITU-T K.12, IEEE C62.31 and IEC 61643-311 GDT standards.

Characteristic	Model No.				
	2038-15-SM	2038-20-SM	2038-23-SM	2038-30-SM	2038-35-SM
DC Sparkover $\pm 25\%$ @ 100 V/s L1/L2 to Gnd ⁽¹⁾	150 V	200 V	230 V	300 V	350 V
Typical Impulse Sparkover ⁽²⁾ L1/L2 to Gnd					
	100V/ μ s	350 V	425 V	450 V	500 V
1000V/ μ s	500 V	575 V	600 V	650 V	750 V

Characteristic	Model No.				
	2038-42-SM	2038-47-SM	2038-60-SM	2038-80-SM	2038-110-SM
DC Sparkover $\pm 25\%$ @ 100 V/s L1/L2 to Gnd ⁽¹⁾	420 V	470 V	600 V	800 V	1100 V
Typical Impulse Sparkover ⁽²⁾ L1/L2 to Gnd					
	100V/ μ s	675 V	750 V	850 V	1150 V
1000V/ μ s	850 V	950 V	1100 V	1400 V	1700 V

Impulse Transverse Delay	100 V/ μ s	< 50 ns
Insulation Resistance (IR)	100 V	> 10 ⁹ Ω
Glow Voltage	10 mA	~ 70 V
Arc Voltage	1 A	~ 10 V
Glow-Arc Transition Current		< 0.5 A
Capacitance	1 MHz	< 1 pF
DC Holdover Voltage ⁽³⁾	135 V (80 V for Model 2038-15)	< 150 ms
Impulse Discharge Current	10000 A, 8/20 μ s ⁽⁴⁾	1 operation min.
	5000 A, 8/20 μ s	10 operations
	200 A, 10/1000 μ s	300 operations
	200 A, 10/700 μ s	500 operations
	10 A, 10/1000 μ s	1500 operations
Alternating Discharge Current	10 Arms, 1 s ⁽⁴⁾	1 operation min.
	5 Arms, 1 s	10 operations
Operating Temperature		-40 to +90 °C
Climatic Category (IEC 60068-1)		40/90/21
Moisture Sensitivity Level		1
ESD Classification (HBM)		6

Notes:

- 2038-15 through 2038-35 UL Recognized , file [E153537](#).
- 2038-80 & 2038-110 UL Recognized , file [E313168](#) (UL 1449).
- The rated discharge current for Mini-TRIGARD™ GDTs is the total current equally divided between each line to ground.
- Surface Mount (SM) parts may show a temporary increase in DCBD after the solder reflow process. Most devices will recover within 24 hours time. It should be noted that there is no quality defect nor change in protection levels during the temporary change in DCBD.
- Sparkover limits after life $\pm 30\%$. IR > 10⁸ Ω .

- Operating characteristics per RUS PE-80 and Telcordia GR 1361 available on request.
- At delivery AQL 0.65 Level II, DIN ISO 2859.
- Bourns recommends reflowing surface mount devices per IPC/JEDEC J-STD-020 rev D.
- ⁽¹⁾ Line to Line DC Sparkover tolerance typically less than +30 % at 100 V/s.
- ⁽²⁾ Impulse Sparkover voltage is defined as typical values of distribution.
- ⁽³⁾ Network applied.
- ⁽⁴⁾ DC Sparkover may exceed $\pm 30\%$ but will continue to protect without venting.

*RoHS Directive 2015/863, Mar 31, 2015 and Annex.
Specifications are subject to change without notice.

Users should verify actual device performance in their specific applications.

The products described herein and this document are subject to specific legal disclaimers as set forth on the last page of this document, and at www.bourns.com/docs/legal/disclaimer.pdf.

Product Dimensions

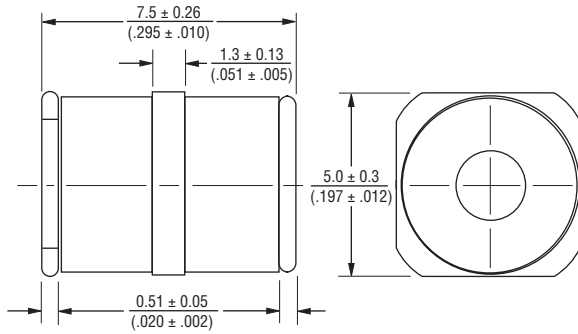

Recommended Pad Layout

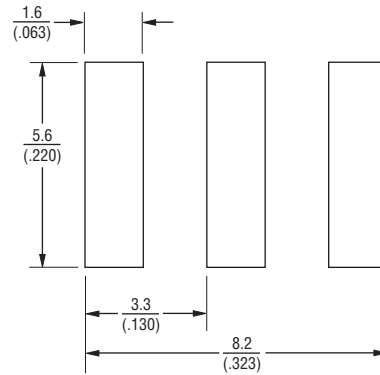

DIMENSIONS: $\frac{\text{MM}}{\text{(INCHES)}}$

How to Order

2038 - xx - SM - RP LF

- Model Number Designator _____
- Voltage (Divided by 10) _____
- Surface Mount _____
- Packaging Options _____
 - Blank = Bulk Packaging (Standard)
 - RP = Reelpack (Optional)
 - RP2 = Reelpack (Optional)
- RoHS Compliant Option _____
 - Blank = Standard Product
 - LF = RoHS Compliant Product

Packaging Specifications

Model	Standard Packaging Quantity			
	Bulk (Bag)	Tray	Box	Reel
2038-xx-SM	250		1000	
2038-xx-SM-RP				1000
2038-xx-SM-RP2				1000

The optional -RP & -RP2 reels are 330 mm in diameter and 23 mm wide.

-RP

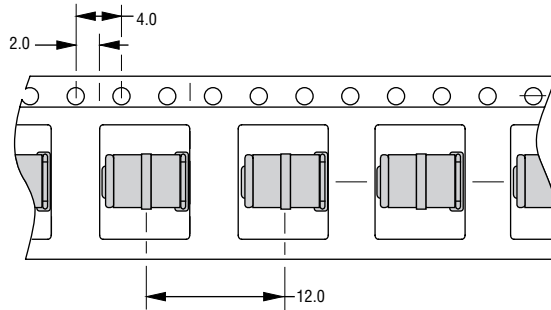

-RP2

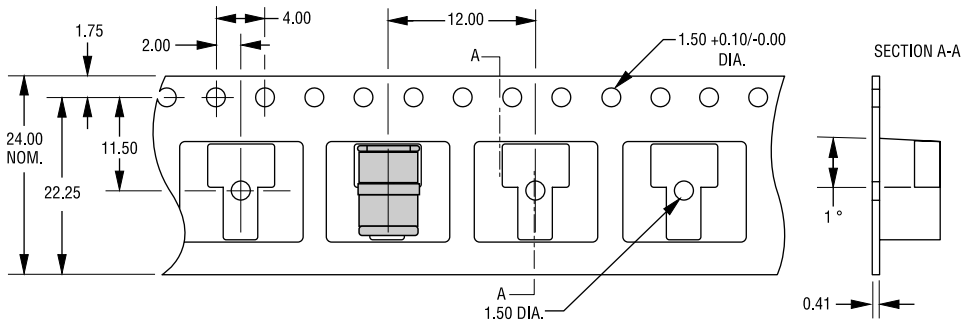

TOLERANCES: ± 0.13 UNLESS OTHERWISE SPECIFIED
 DIMENSIONS: MILLIMETERS

REV. O 08/20

Specifications are subject to change without notice.
 Users should verify actual device performance in their specific applications.
 The products described herein and this document are subject to specific legal disclaimers as set forth on the last page of this document, and at www.bourns.com/docs/legal/disclaimer.pdf.