

KINGS[®]
by WINCHESTER
ELECTRONICS

RF CONNECTOR SOLUTIONS



Connecting Innovation to Application[®]



Winchester Electronics was established in 1941 and is today a global leader in the design, development, and deployment of interconnect technology. Headquartered in Middlebury, Connecticut, USA, Winchester operates worldwide with modern, electronically linked design, manufacturing, sales, and distribution facilities in the United States, Mexico, China, and Malaysia.



Winchester's competitive advantage is our ability to solve even the most difficult interconnect problems, deploy design solutions globally to meet the customer's manufacturing needs, and offer true supply chain management techniques to deliver value through our high-mix, low-volume manufacturing model. Our global IT infrastructure and worldwide communication capabilities allow for continuous information access in support of customer opportunities. The acquisition of Kings Electronics expanded our technological capabilities and broadened our market base and product offering.

Kings Electronics was originally founded in 1947 and has provided numerous contributions to the advancement of connector technology, including the K-Grip® crimp style connector, True 75 Ohm BNC connectors, and the industry standard Tri-Loc® triaxial camera connector

series. This long-trusted RF KINGS® Brand is highly regarded by customers in the Broadcast, Telecommunications, and Commercial and Military Aviation industries.

With over 125 years of collective industry experience, Winchester Electronics and the KINGS® Brand create value for our customers by offering a proven combination of quality products, efficient manufacturing, dedicated service, and inventive design solutions.









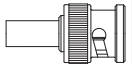
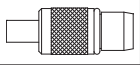
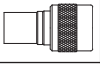
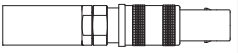
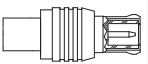
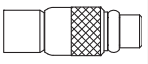
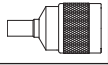
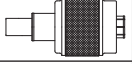
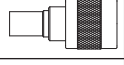

In addition to the KINGS® Brand RF Connectors, Winchester Electronics also manufactures a wide variety of PCB and Power Connectors, as well as value-added cable and electromechanical assemblies for customers in the Wireless Infrastructure, Computer, Industrial, and Medical Equipment industries.

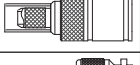
Realizing its responsibility to the environment, every Winchester Electronics facility is ISO Certified and all of our products are manufactured in compliance with the European Union RoHS directive.

Providing superior products built to stringent specifications, the new Winchester Electronics is a valuable extension of your product development team. With the ability to rapidly develop engineered solutions at reduced costs and time-to-market, we can help your company maintain its competitive edge.

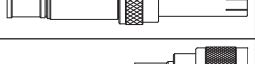
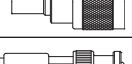
| | |
|--|-----|
| Connector Selection Guide | 04 |
| 50 Ohm BNC Series | 05 |
| BMA Series | 16 |
| C Series | 20 |
| K-Loc® Series | 24 |
| MCX Series | 26 |
| MMCX Series | 29 |
| N Series | 32 |
| QC-N Series | 42 |
| SC Series | 44 |
| SMA Series | 47 |
| QC-SMA™ Series | 59 |
| SMB Series | 61 |
| TNC Series | 66 |
| TRB Series | 81 |
| TRT Series | 84 |
| 10 KV Series | 86 |
| 20 KV Series | 88 |
| HN Series | 90 |
| MHV Series | 93 |
| SHV Series | 96 |
| 75 Ohm BNC Series | 99 |
| Long Barrel BNC | 102 |
| Patch Plugs | 104 |
| Patch Cord Assemblies | 106 |
| Tri-Loc® | 108 |
| International Tri-Loc® | 113 |
| 1.0/2.3 DIN | 116 |
| Audio/Video Patching System | 118 |
| Mid-Size Video Jacks & Jackfields | 120 |
| Standard-Size Video Jacks & Jackfields | 122 |
| Populated Video Jackfields | 124 |
| Tools & Accessories | 127 |
| Strain Relief Boots | 128 |
| Installation Tools | 130 |
| Splices | 131 |
| Mounting Holes | 132 |
| Cable Procedures | 134 |
| Cable Reference Table | 235 |
| KINGS® Cable Groups | 239 |
| Glossary | 241 |
| Military to KINGS® Cross-Reference Chart | 242 |
| Part Number Index | 245 |

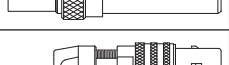
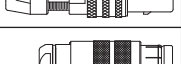
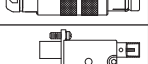
CONNECTOR SELECTION GUIDE

| | Series | Cable Type | Size | Coupling | Impedance | Max Frequency | Max VSWR | Voltage Rating |
|---|------------------------------|--|-----------------|---------------|--------------|---------------|----------|----------------|
|  | BNC | Coaxial | Miniature | Bayonet | 50 & 75 Ohm | 4 GHz | 1.3 | 500 VRMS |
|  | BMA | Coaxial | Sub-Miniature | Blind Mate | 50 Ohm | 18 GHz | 1.1 | 1000 VRMS |
|  | C | Coaxial | Medium | Bayonet | 50 Ohm | 11 GHz | 1.4 | 1000 VRMS |
|  | K-Loc® | Coaxial | Miniature | Positive Lock | 50 Ohm | — | — | 500 VRMS |
|  | MCX | Coaxial | Micro-Miniature | Snap On | 50 & 75 Ohm | 6 GHz | 1.3 | 335 VRMS |
|  | MMCX | Coaxial | Micro-Miniature | Snap On | 50 Ohm | 6 GHz | 1.3 | 170 VRMS |
|  | N | Coaxial | Medium | Threaded | 50 Ohm | 11 GHz | 1.3 | 1000 VRMS |
|  | QC-N™ | Coaxial | Medium | Snap On | 50 Ohm | 11 GHz | 1.2 | 1000 VRMS |
|  | SC | Coaxial | Medium | Threaded | 50 Ohm | 11 GHz | 1.3 | 1000 VRMS |
|  | SMA | Coaxial | Sub-Miniature | Threaded | 50 Ohm | 18 GHz | 1.3 | 500 VRMS |
|  | QC-SMA™ | Coaxial | Sub-Miniature | Snap On | 50 Ohm | 6 GHz | 1.3 | 335 VRMS |
|  | SMB | Coaxial | Sub-Miniature | Snap On | 50 & 75 Ohm | 4 GHz | 1.5 | 250 VRMS |
|  | TNC | Coaxial | Miniature | Threaded | 50 & 75 Ohm | 11 GHz | 1.3 | 500 VRMS |
|  | TRB | Triaxial | Miniature | Bayonet | Non-Constant | 500 MHz | — | 400 VRMS |
|  | TRT | Triaxial | Miniature | Threaded | Non-Constant | 500 MHz | — | 400 VRMS |
|  | 10 KV | Coaxial | Medium | Bayonet | Non-Constant | — | — | 10 KV DC |
|  | 20 KV | Coaxial | Medium | Bayonet | Non-Constant | — | — | 20 KV DC |
|  | HN | Coaxial | Medium | Threaded | 50 Ohm | 4 GHz | 1.3 | 1500 VRMS |
|  | MHV | Coaxial | Miniature | Bayonet | Non-Constant | 500 MHz | — | 3500 VRMS |
|  | SHV | Coaxial | Miniature | Bayonet | Non-Constant | 300 MHz | — | 3500 VRMS |
|  | Patch Plugs | Coaxial | Medium | Push On | 75 Ohm | 2.5 GHz | — | 500 VRMS |
|  | Tri-Loc® | Triaxial | Large | Push On | 75 Ohm | 2.5 GHz | — | 1500 VRMS |
|  | International Tri-Loc® | Triaxial | Large | Push On | 75 Ohm | 3.0 GHz | — | 1500 VRMS |
|  | Audio/Video Patching Systems | See Catalog Pages 112-113 for Further Details. | | | | | | |



- 50 Ohm Nominal Impedance.
- Quick connect & disconnect bayonet coupling design.
- Durable brass bodies with Silver or Nickel plating.
- Small & lightweight.
- Commercial and Military-Specified versions available.
- Frequency Range: Up to 4 GHz

SPECIFICATIONS

MATERIAL

| | |
|------------------|---|
| Body: | Brass |
| Crimp Sleeves: | Commercial Bronze Alloy |
| Center Contacts: | Brass (Male) Beryllium Copper (Female) |
| Outer Contacts: | Beryllium Copper or Brass (Male) |
| Insulators: | PTFE |
| Gaskets & Seals: | Silicone Rubber |

FINISHES

| | |
|------------------|------------------|
| Body: | Silver or Nickel |
| Center Contacts: | Gold |

ENVIRONMENTAL

| | |
|----------------------|--------------------------------------|
| Temperature Range: | -65° C to +165° C |
| Vibration: | MIL-STD-202, Method 204, Condition B |
| Shock: | MIL-STD-202, Method 213, Condition B |
| Corrosion: | MIL-STD-202, Method 101, Condition B |
| Moisture Resistance: | MIL-STD-202, Method 106 |

ELECTRICAL

| | |
|------------------|-----------------------|
| Impedance: | 50 Ohms |
| Frequency Range: | DC to 4 GHz |
| Voltage Rating: | 500 Volts RMS |
| VSWR: | 1.30 Max, DC to 4 GHz |
| Insertion Loss: | .2 dB Max at 3 GHz |

MECHANICAL

| | |
|------------------|---|
| Life: | 500 Cycles |
| Cable Retention: | Non-Crimp: 40 Pounds Minimum Crimp: 10 to 40 Pounds, Depending on Cable Size |

INTERFACE DIMENSIONS



| Dimensions in inches with metric equivalents (mm) in parentheses | | | | | |
|--|-------------|-------------|---------|-------------|-------------|
| Dim Ltr | Minimum | Maximum | Dim Ltr | Minimum | Maximum |
| A | .355 (9.76) | .390 (9.91) | E | .210 (5.33) | .230 (5.84) |
| B | Gauge Test | | F | .006 (0.15) | |
| C | .190 (4.83) | | L | .003 (0.08) | |
| D | .052 (1.32) | .054 (1.37) | P | .208 (5.28) | .228 (5.79) |



| Dim Ltr | Minimum | Maximum | Dim Ltr | Minimum | Maximum |
|---------|--------------|--------------|---------|--------------|-------------|
| A | .432 (10.97) | .436 (11.07) | J | .186 (4.72) | .206 (5.23) |
| B | .378 (9.60) | .382 (9.70) | K | | .006 (0.15) |
| C | .327 (8.31) | .333 (8.46) | N | .346 (8.79) | .356 (9.04) |
| D | .319 (8.10) | .321 (8.15) | P | | .256 (6.50) |
| E | | .186 (4.72) | R | .015 (0.38) | .030 (0.76) |
| F | .204 (5.18) | .208 (5.28) | S | .414 (10.52) | |
| G | .327 (8.31) | .335 (8.51) | T | .188 (4.78) | .208 (5.28) |
| H | .075 (1.91) | .081 (2.06) | | | |

PLUG - CONVENTIONAL



FIGURE 1

PLUG - TAPER GRIP

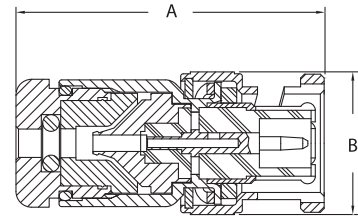

FIGURE 2

PLUGS - K-GRIP

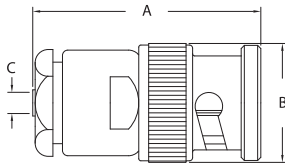

FIGURE 3

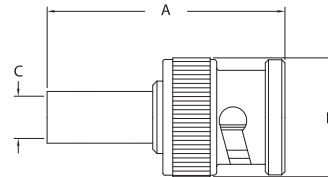

FIGURE 4

| Item Number | Military PN | Product Description | Gender | Finish | Dimensions | | | | Cable Group | Cable Procedure | Crimp Die | Mounting Hole | Figure # |
|---------------|----------------|-------------------------------------|--------|--------|------------|-------|-------|---|-------------|-----------------|-----------|---------------|----------|
| | | | | | A | B | C | D | | | | | |
| KC-59-588 M06 | | Plug, Direct Solder | M | Nickel | 0.750 | 0.560 | | | 49 | 3-81 | NONE | | N/S |
| KC-59-89 | | Plug, Conventional | M | Silver | 1.090 | 0.570 | 0.120 | | B | CP-1004 | NONE | | 1 |
| KC-59-284 | | Plug, Conventional | M | Nickel | 1.080 | 0.560 | | | B1 | CP-1004.1 | NONE | | 1 |
| KC-59-544 | M39012/16-0101 | Plug, Conventional | M | Silver | 1.080 | 0.560 | | | DE | CP-1050 | NONE | | 1 |
| KC-59-141 | | Plug, Conventional | M | Nickel | 1.090 | 0.560 | | | DE | CP-1004 | NONE | | 1 |
| KC-59-545 | M39012/16-0102 | Plug, Conventional | M | Silver | 1.080 | 0.560 | | | G1 | CP-1050 | NONE | | 1 |
| KC-59-548 | M39012/16-0118 | Plug, Conventional | M | Silver | 1.080 | 0.560 | | | H | CP-1050 | NONE | | 1 |
| KC-59-248 M06 | | Plug, Conventional | M | Nickel | 1.660 | 0.750 | | | MN | CP-1005 | NONE | | 1 |
| KC-59-248 | | Plug, Conventional | M | Silver | 1.660 | 0.750 | | | M1 | CP-1005 | NONE | | 1 |
| 755-86-5 | M39012/16-0220 | Plug, Taper Grip | M | Silver | 1.250 | 0.593 | | | 3 | 3-562 | NONE | | 2 |
| 755-100-5 | | Plug, Taper Grip | M | Silver | 1.250 | 0.593 | | | B1 | 3-562 | NONE | | 2 |
| 755-74-5 | M39012/16-0101 | Plug, Taper Grip | M | Silver | 1.250 | 0.560 | | | D | 3-561 | NONE | | 2 |
| KC-59-175 | | Plug, Conventional/Crimp | M | Nickel | 1.080 | 0.560 | | | A | CP-228A | KTH-2008 | | 3 |
| KC-59-136 | | Plug, Conventional/Crimp | M | Silver | 1.080 | 0.560 | | | A | CP-228A | KTH-2008 | | 3 |
| KC-59-111 | M39012/16B0009 | Plug, Conventional/Crimp | M | Silver | 1.150 | 0.570 | | | C1 | CP-226A-2 | KTH-2007 | | 3 |
| KC-59-61 | M39012/16B0004 | Plug, Conventional/Crimp | M | Silver | 1.170 | 0.560 | | | D | CP-201A | KTH-2001 | | 3 |
| KC-59-188 | M39012/16B0007 | Plug, Conventional/Crimp | M | Silver | 1.170 | 0.570 | | | E2 | CP-201A | KTH-2001 | | 3 |
| KC-59-239 | | Plug, Conventional/Crimp, Polarized | M | Silver | 1.090 | 0.560 | 0.150 | | B | CP-225A | KTH-2024 | | 3 |
| KC-59-156 | | Plug, Conventional/Crimp, Polarized | M | Nickel | 1.170 | 0.560 | | | D | CP-201A | KTH-2001 | | 3 |
| KC-59-155 | | Plug, Conventional/Crimp, Polarized | M | Silver | 1.170 | 0.560 | | | D | CP-201A | KTH-2001 | | 3 |
| KC-59-288 | | Plug, Crimp, Booted | M | Nickel | 1.910 | 0.560 | | | B1 | CP-425 | KTH-2024 | | 4 |
| KC-59-184 | | Plug, Crimp, Booted | M | Silver | 1.910 | 0.560 | | | D | CP-420 | KTH-2001 | | 4 |
| KC-59-358 | | Plug, Crimp, Booted | M | Nickel | 1.900 | 0.560 | | | G1 | CP-420 | KTH-2002 | | 4 |

PLUGS - K-GRIP, JR

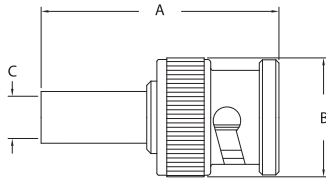

FIGURE 4

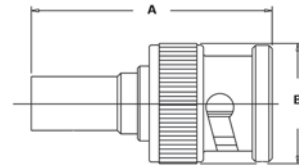

FIGURE 5

| Item Number | Military PN | Product Description | Gender | Finish | Dimensions | | | | Cable Group | Cable Procedure | Crimp Die | Mounting Hole | Figure # |
|---------------|----------------|---------------------------|--------|--------|------------|-------|-------|---|-------------|-----------------|-----------|---------------|----------|
| | | | | | A | B | C | D | | | | | |
| KC-59-482 | | Plug, Crimp | M | Nickel | 1.100 | 0.570 | | | 24 | CP-401 | KTH-2002 | | 4 |
| KC-59-485 | | Plug, Crimp | M | Nickel | 1.780 | 0.560 | | | 81 | CP-5402 | KTH-2004 | | 4 |
| 755-129-9 | | Plug, Crimp | M | Nickel | 0.910 | 0.560 | | | B1 | CP-406 | KTH-2032 | | 4 |
| KC-59-95 | | Plug, Crimp | M | Silver | 0.910 | 0.560 | | | B1 | CP-406 | KTH-2032 | | 4 |
| 755-63-9 | | Plug, Crimp | M | Nickel | 1.060 | 0.490 | | | B2 | 3-483-2 | KTH-2021 | | 4 |
| KC-59-107 | | Plug, Crimp | M | Silver | 0.980 | 0.560 | 0.180 | | C | CP-409 | KTH-2007 | | 4 |
| 755-116-5 | M39012/16-0016 | Plug, Crimp | M | Silver | 1.120 | 0.570 | | | C1 | CP-465 | KTH-2007 | | 4 |
| 755-119-5 | M39012/16-0501 | Plug, Crimp | M | Silver | 1.120 | 0.560 | | | C1 | CP-465 | KTH-2007 | | 4 |
| 755-120-5 | M39012/16-0502 | Plug, Crimp | M | Silver | 1.120 | 0.560 | | | C2 | CP-465 | KTH-2007 | | 4 |
| 755-114-9 | | Plug, Crimp | M | Nickel | 1.120 | 0.560 | | | D | CP-465 | KTH-2001 | | 4 |
| 755-114-5 | M39012/16-0013 | Plug, Crimp | M | Silver | 1.120 | 0.560 | | | D | CP-465 | KTH-2001 | | 4 |
| 755-122-5 | M39012/16-0504 | Plug, Crimp | M | Silver | 1.120 | 0.560 | | | D | CP-465 | KTH-2001 | | 4 |
| 755-112-9 | | Plug, Crimp | M | Nickel | 1.120 | 0.560 | | | E1 | CP-465 | KTH-2001 | | 4 |
| 755-112-5 | M39012/16-0014 | Plug, Crimp | M | Silver | 1.120 | 0.560 | | | E1 | CP-465 | KTH-2001 | | 4 |
| 755-121-5 | M39012/16-0503 | Plug, Crimp | M | Silver | 1.120 | 0.560 | | | E1 | CP-465 | KTH-2001 | | 4 |
| 755-115-5 | M39012/16-0015 | Plug, Crimp | M | Silver | 1.120 | 0.560 | | | G1 | CP-465 | KTH-2002 | | 4 |
| 755-117-5 | M39012/16-0017 | Plug, Crimp | M | Silver | 1.120 | 0.560 | | | G2 | CP-465 | KTH-2002 | | 4 |
| 755-118-5 | M39012/16-0020 | Plug, Crimp | M | Silver | 1.120 | 0.560 | | | H | CP-465 | KTH-2002 | | 4 |
| KC-59-577 M06 | | Plug, Crimp | M | Nickel | 1.690 | 0.590 | | | M1 | CP-480 | KTH-2004 | | 4 |
| 755-128-9 | | Plug, Crimp, Weatherproof | M | Nickel | 1.060 | 0.560 | 0.120 | | B1 | CP-402 | KTH-2081 | | 5 |
| KC-59-280 | | Plug, Crimp, Weatherproof | M | Silver | 1.080 | 0.560 | | | B1 | CP-402 | KTH-2081 | | 5 |
| KC-59-446 | | Plug, Crimp, Weatherproof | M | Nickel | 1.140 | 0.560 | | | C2 | CP-5401 | KTH-2067 | | 5 |
| 755-127-9 | | Plug, Crimp, Weatherproof | M | Nickel | 1.140 | 0.560 | | | D | CP-465 | KTH-2061 | | 5 |
| KC-59-195 | M39012/16B0004 | Plug, Crimp, Weatherproof | M | Silver | 1.120 | 0.570 | | | DE | CP-401 | KTH-2061 | | 5 |
| KC-59-383 | | Plug, Crimp, Weatherproof | M | Nickel | 1.130 | 0.570 | | | E1 | CP-472 | KTH-2061 | | 5 |
| KC-59-232 | | Plug, Crimp, Weatherproof | M | Nickel | 1.140 | 0.570 | | | G1 | CP-401 | KTH-2062 | | 5 |
| KC-59-220 | M39012/16B0008 | Plug, Crimp, Weatherproof | M | Silver | 1.110 | 0.560 | | | G1 | CP-401 | KTH-2062 | | 5 |
| 755-79-9 | | Plug, Crimp, Weatherproof | M | Nickel | 1.330 | 0.593 | | | 15 | 3-564-1 | KTH-2214 | | 5 |
| 755-78-9 | | Plug, Crimp, Weatherproof | M | Nickel | 1.110 | 0.593 | | | 16 | 3-546-1 | KTH-2161 | | 5 |
| 755-93-9 | | Plug, Crimp, Weatherproof | M | Nickel | 1.140 | 0.593 | | | 17 | 3-546-1 | KTH-2216 | | 5 |
| 755-104-9 | | Plug, Crimp, Weatherproof | M | Nickel | 1.100 | 0.570 | | | 19 | 3-546-2 | KTH-2213 | | 5 |
| KC-59-267 | | Plug, Crimp, Weatherproof | M | Nickel | 1.690 | 0.750 | 0.630 | | 45 | CP-5401 | KTH-2161 | | 5 |

ANGLE PLUG - CONVENTIONAL

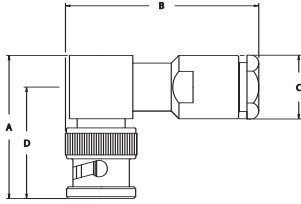

FIGURE 6

ANGLE PLUG - K-GRIP, JR.

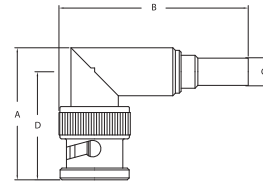

FIGURE 7

ANGLE PLUG - TAPER GRIP



FIGURE 8

| Item Number | Military PN | Product Description | Gender | Finish | Dimensions | | | | Cable Group | Cable Procedure | Crimp Die | Mounting Hole | Figure # |
|-------------|----------------|------------------------------------|--------|--------|------------|-------|-------|-------|-------------|-----------------|-----------|---------------|----------|
| | | | | | A | B | C | D | | | | | |
| KC-59-533 | M39012/20-0101 | Plug, Conventional, Angle | M | Silver | 1.130 | 1.530 | 0.500 | 0.880 | D | CP-1050 | NONE | | 6 |
| 756-10-9 | | Plug, Crimp, Angle, Weatherproof | M | Nickel | 1.030 | 1.440 | 0.379 | 0.840 | 15 | 3-546-1 | KTH-2214 | | 7 |
| 756-16-9 | | Plug, Crimp, Angle, Weatherproof | M | Nickel | 1.130 | 1.740 | 0.379 | 0.890 | 16 | 3-546-1 | KTH-2161 | | 7 |
| 756-18-9 | | Plug, Crimp, Angle, Weatherproof | M | Nickel | 1.130 | 1.730 | 0.379 | 0.890 | 17 | 3-546-1 | KTH-2216 | | 7 |
| KC-59-447 | | Plug, Crimp, Angle, Weatherproof | M | Nickel | 1.130 | 1.700 | 0.370 | 0.890 | 45 | CP-5401 | KTH-2161 | | 7 |
| KC-59-109 | | Plug, Crimp, Angle | M | Silver | 1.030 | 1.430 | 0.370 | 0.840 | B1 | CP-406 | KTH-2032 | | 7 |
| 756-6-9 | | Plug, Crimp, Angle | M | Nickel | 0.930 | 0.790 | 0.375 | 0.750 | B2 | 3-483-1 | KTH-2021 | | 7 |
| KC-59-408 | M39012/20-0501 | Plug, Crimp, Angle | M | Silver | 1.700 | 1.130 | 0.570 | | C1 | CP-465 | KTH-2007 | | 7 |
| KC-59-418 | M39012/20-0502 | Plug, Crimp, Angle | M | Silver | 1.130 | 1.700 | 0.370 | 0.890 | C2 | CP-465 | KTH-2007 | | 7 |
| 756-21-7 | M39012/20-0006 | Plug, Crimp, Angle | M | Silver | 1.030 | 1.490 | 0.379 | 0.840 | D | CP-465 | KTH-2001 | | 7 |
| KC-59-420 | M39012/20-0504 | Plug, Crimp, Angle | M | Silver | 1.130 | 1.700 | 0.370 | 0.890 | D | CP-465 | KTH-2001 | | 7 |
| KC-59-270 | | Plug, Crimp, Angle | M | Nickel | 1.030 | 1.600 | 1.320 | 0.850 | E1 | CP-401 | KTH-2001 | | 7 |
| 756-19-7 | M39012/20-0007 | Plug, Crimp, Angle | M | Silver | 1.030 | 1.490 | 0.379 | 0.840 | E1 | CP-465 | KTH-2001 | | 7 |
| KC-59-419 | M39012/20-0503 | Plug, Crimp, Angle | M | Silver | 1.130 | 1.700 | 0.370 | 0.890 | E1 | CP-465 | KTH-2001 | | 7 |
| KC-59-287 | | Plug, Crimp, Angle, Weatherproof | M | Nickel | 1.040 | 1.400 | 0.375 | 0.840 | B1 | CP-402 | KTH-2081 | | 7 |
| KC-59-261 | | Plug, Crimp, Angle, Weatherproof | M | Nickel | 1.125 | 1.725 | 0.380 | 1.440 | D | CP-5401 | KTH-2061 | | 7 |
| KC-59-246 | M39012/20B0003 | Plug, Crimp, Angle, Weatherproof | M | Silver | 1.040 | 1.670 | 0.560 | 0.760 | E1 | 3-334 | KTH-2061 | | 7 |
| KC-59-444 | | Plug, Crimp, Angle, Weatherproof | M | Nickel | 1.140 | 1.390 | 0.437 | 0.890 | G1 | CP-5401 | KTH-2062 | | 7 |
| KC-59-212 | | Plug, Crimp, Angle, W/P, Polarized | M | Nickel | 1.620 | 1.040 | 0.570 | | D | CP-401 | KTH-2061 | | 7 |
| 756-9-5 | M39012/20-0101 | Plug, Taper Grip, Angle | M | Silver | 1.218 | 1.750 | 0.500 | 0.880 | D | 3-561 | NONE | | 8 |
| 756-12-5 | M39012/20-0102 | Plug, Taper Grip, Angle | M | Silver | 1.600 | 1.130 | 0.500 | 1.330 | G1 | 3-561 | NONE | | 8 |

BULKHEAD JACKS



FIGURE 9



FIGURE 10



FIGURE 11

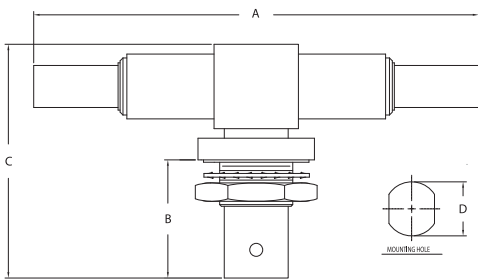

FIGURE 12



FIGURE 13



FIGURE 14

| Item Number | Military PN | Product Description | Gender | Finish | Dimensions | | | | Cable Group | Cable Procedure | Crimp Die | Mounting Hole | Figure # |
|---------------|----------------|--------------------------------------|--------|--------|------------|-------|-------|-------|-------------|-----------------|-----------|---------------|----------|
| | | | | | A | B | C | D | | | | | |
| KC-19-152 | | Jack, Crimp, Bulkhd | F | Nickel | 1.340 | 0.560 | 0.500 | 0.163 | B1 | CP-430 | KTH-2024 | C | 9 |
| KC-19-258 | | Jack, Conventional, Bulkhd | F | Nickel | 1.140 | | 0.500 | | 50 | CP-2101 | NONE | B | 9 |
| KC-19-110 | | Jack, Conventional, Bulkhd | F | Silver | 1.150 | 0.810 | 0.690 | 0.241 | A | CP-1012 | NONE | A | 10 |
| KC-19-54 | | Jack, Conventional, Bulkhd | F | Silver | 1.150 | 0.810 | 0.690 | | B | CP-1004.1 | NONE | A | 10 |
| KC-19-50 | M39012/19B0003 | Jack, Conventional/Crimp, Bulkhd | F | Silver | 1.240 | 0.810 | 0.690 | | D | CP-201A | KTH-2001 | A | 10 |
| 752-27-9 | | Jack, Crimp, Bulkhd | F | Nickel | 1.550 | 0.810 | 0.630 | 0.241 | 24 | CP-465 | KTH-2002 | A | 11 |
| KC-19-323 M06 | | Jack, Crimp, Bulkhd | F | Nickel | 1.380 | 0.910 | 0.630 | 0.241 | B | CP-5417 | KTH-2138 | A | 11 |
| KC-19-138 | | Jack, Crimp, Bulkhd, Isolated Ground | F | Nickel | 1.265 | 0.885 | 0.630 | 0.173 | B1 | CP-431 | KTH-2032 | A | 11 |
| KC-19-93 | | Jack, Crimp, Bulkhd | F | Nickel | 1.390 | 0.810 | 0.630 | 0.238 | B1 | CP-407 | KTH-2032 | A | 11 |
| KC-19-293 M06 | | Jack, Crimp, Bulkhd | F | Nickel | 1.380 | 0.810 | 0.630 | 0.241 | B2 | CP-5417 | KTH-2140 | A | 11 |
| KC-19-248 | M39012/19-0502 | Jack, Crimp, Bulkhd | F | Silver | 1.400 | 0.810 | 0.630 | 0.241 | C2 | CP-465 | KTH-2007 | A | 11 |
| KC-19-207 | M39012/19-0013 | Jack, Crimp, Bulkhd | F | Silver | 1.550 | 0.810 | 0.690 | 0.241 | D | CP-465 | KTH-2001 | A | 11 |
| KC-19-250 | M39012/19-0504 | Jack, Crimp, Bulkhd | F | Silver | 1.400 | 0.810 | 0.690 | 0.241 | D | CP-465 | KTH-2001 | A | 11 |
| KC-19-140 | | Jack, Crimp, Bulkhd | F | Nickel | 1.550 | 0.810 | 0.690 | 0.241 | E1 | CP-405 | KTH-2001 | A | 11 |
| KC-19-208 | M39012/19-0014 | Jack, Crimp, Bulkhd | F | Silver | 1.550 | 0.810 | 0.690 | 0.241 | E1 | CP-465 | KTH-2001 | A | 11 |
| KC-19-249 | M39012/19-0503 | Jack, Crimp, Bulkhd | F | Silver | 1.400 | 0.810 | 0.630 | 0.241 | E1 | CP-465 | KTH-2001 | A | 11 |
| KC-19-212 | M39012/19-0020 | Jack, Crimp, Bulkhd | F | Silver | 1.550 | 0.806 | 0.690 | 0.241 | H | CP-465 | KTH-2002 | A | 11 |
| KC-19-122 | | Jack, Crimp, Bulkhd, Tee | F | Silver | 2.680 | 0.700 | 1.390 | 0.500 | D | CP-401 | KTH-2001 | | 12 |
| KC-19-170 | | Jack, Crimp, Bulkhd, Weatherproof | F | Nickel | 1.580 | 0.810 | 0.630 | 0.241 | 45 | CP-5401 | KTH-2161 | A | 13 |
| KC-19-261 | | Jack, Crimp, Bulkhd, Weatherproof | F | Nickel | 1.580 | 0.810 | 0.690 | 0.241 | G1 | CP-5401 | KTH-2062 | A | 13 |
| KC-19-175 | | Jack, Conventional, Bulkhd | F | Nickel | 1.150 | 0.810 | 0.690 | 0.241 | B1 | CP-1004.1 | NONE | A | 14 |
| 752-34-5 | M39012/19-0220 | Jack, Conventional, Bulkhd | F | Silver | 1.250 | 0.810 | 0.690 | | B1 | 3-562 | NONE | A | 14 |
| KC-19-282 | M39012/19-0101 | Jack, Conventional, Bulkhd | F | Silver | 1.150 | 0.810 | 0.690 | 0.241 | D | CP-1050 | NONE | A | 14 |

JACK - K-GRIP, JR.



FIGURE 15

PANEL JACK - CONVENTIONAL

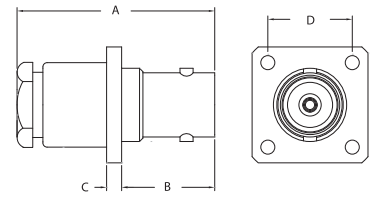

FIGURE 16

PANEL JACKS - K-GRIP, JR.

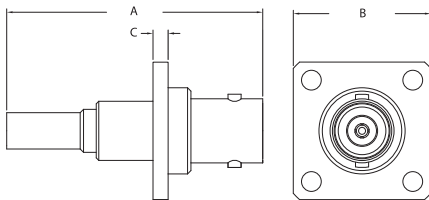

FIGURE 17



FIGURE 18

| Item Number | Military PN | Product Description | Gender | Finish | Dimensions | | | | Cable Group | Cable Procedure | Crimp Die | Mounting Hole | Figure # |
|---------------|----------------|--|--------|--------|------------|-------|-------|-------|-------------|-----------------|-----------|---------------|----------|
| | | | | | A | B | C | D | | | | | |
| KC-39-50 | | Jack, Crimp | F | Nickel | 0.980 | 0.560 | | | B1 | CP-406 | KTH-2032 | | 15 |
| KC-39-105 | M39012/17-0502 | Jack, Crimp | F | Silver | 1.180 | 0.560 | | | C2 | CP-465 | KTH-2001 | | 15 |
| KC-39-38 | | Jack, Crimp | F | Nickel | 1.170 | 0.560 | | | D | CP-401 | KTH-2001 | | 15 |
| KC-39-103 | M39012/17-0504 | Jack, Crimp | F | Silver | 1.180 | 0.560 | | | D | CP-465 | KTH-2001 | | 15 |
| KC-39-106 | M39012/17-0503 | Jack, Crimp | F | Silver | 1.180 | 0.560 | | | E1 | CP-465 | KTH-2001 | | 15 |
| KC-39-93 | M39012/17-0014 | Jack, Crimp | F | Silver | 1.170 | 0.560 | | | E1 | CP-465 | KTH-2001 | | 15 |
| KC-39-45 | | Jack, Crimp | F | Nickel | 1.170 | 0.560 | | | G1 | CP-401 | KTH-2002 | | 15 |
| KC-39-98 | M39012/17-0020 | Jack, Crimp | F | Silver | 1.180 | 0.560 | | | H | CP-465 | KTH-2002 | | 15 |
| KC-39-134 M07 | | Jack, Crimp, Polarized | M | Silver | 1.170 | 0.560 | | | E1 | CP-465 | KTH-2001 | | 15 |
| KC-19-288 M06 | | Jack, Conventional, Panel | F | Nickel | 1.160 | 0.550 | 0.090 | 0.500 | B1 | CP-1004.1 | NONE | | 16 |
| KC-19-94 | | Jack, Conventional, Panel | F | Silver | 1.150 | 0.550 | 0.090 | 0.500 | B1 | CP-1004.1 | NONE | | 16 |
| KC-19-02 | M39012/18-0102 | Jack, Conventional, Panel | F | Silver | 1.150 | 0.550 | 0.090 | 0.500 | D | CP-1050 | NONE | | 16 |
| 751-11-9 | | Jack, Crimp, Panel, Weatherproof | F | Nickel | 1.540 | 0.820 | 0.090 | | 15 | 3-546-1 | KTH-2214 | | 17 |
| 751-10-9 | | Jack, Crimp, Panel, Weatherproof | F | Nickel | 1.410 | 0.820 | 0.090 | | 16 | 3-546-1 | KTH-2161 | | 17 |
| 751-20-9 | | Jack, Crimp, Panel, Weatherproof | F | Nickel | 1.410 | 0.820 | 0.090 | | 17 | 3-546-1 | KTH-2216 | | 17 |
| KC-19-129 | M39012/18B0007 | Jack, Crimp, Panel, Weatherproof | F | Silver | 1.180 | 0.690 | 0.090 | | E | CP-401 | KTH-2061 | | 17 |
| KC-19-329 M06 | | Jack, Crimp, Panel, Weatherproof | F | Nickel | 1.180 | 0.690 | 0.090 | | C2 | CP-5401 | KTH-2067 | | 17 |
| KC-19-256 | | Jack, Crimp, Panel, Weatherproof | F | Nickel | 1.440 | 0.690 | 0.090 | | D | CP-5401 | KTH-2061 | | 17 |
| KC-19-328 M06 | | Jack, Crimp, Panel, Weatherproof | F | Nickel | 1.440 | 0.690 | 0.090 | | E1 | CP-5401 | KTH-2061 | | 17 |
| 751-26-9 | | Jack, Crimp, Panel, Weatherproof | F | Nickel | 1.810 | 0.690 | 0.090 | | N3 | CP-5402 | KTH-2105 | | 17 |
| 751-22-9 | | Jack, Crimp, Panel, W/P, Locking Threads | F | Nickel | 1.410 | 0.690 | 0.090 | | 16 | 3-546-1 | KTH-2161 | | 17 |
| KC-19-244 | M39012/18-0502 | Jack, Crimp, Panel | F | Silver | 1.180 | 0.690 | 0.090 | | C2 | CP-465 | KTH-2007 | | 18 |
| KC-19-239 | | Jack, Crimp, Panel | F | Silver | 1.410 | 0.690 | 0.090 | | E1 | CP-465 | KTH-2001 | | 18 |
| KC-19-245 | M39012/18-0503 | Jack, Crimp, Panel | F | Silver | 1.180 | 0.690 | 0.090 | | E1 | CP-465 | KTH-2001 | | 18 |

ACCESSORIES



FIGURE 19



FIGURE 20

JACK - CONVENTIONAL

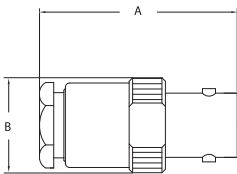

FIGURE 21

RECEPTACLE



FIGURE 22

| Item Number | Military PN | Product Description | Gender | Finish | Dimensions | | | | Cable Group | Cable Procedure | Crimp Die | Mounting Hole | Figure # |
|-------------|----------------|-------------------------|--------|------------|------------|-------|-------|-------|-------------|-----------------|-----------|---------------|----------|
| | | | | | A | B | C | D | | | | | |
| KC-89-59 | | Dust Cap & Chain | M | Olive Drab | 0.700 | 0.560 | 0.250 | 2.000 | NONE | NONE | NONE | | 19 |
| KC-89-87 | M39012/25-0006 | Dust Cap & Chain | M | Silver | 0.670 | 0.550 | 0.140 | 2.250 | NONE | NONE | NONE | | 19 |
| 758-42-9 | | Dust Cap & Nylon Cord | M | Nickel | 0.700 | 0.560 | 1.250 | 2.000 | NONE | NONE | NONE | | 19 |
| KC-89-39 | | Dust Cap & Nylon Cord | M | Olive Drab | 0.700 | 0.560 | 0.250 | 2.500 | NONE | NONE | NONE | | 19 |
| 758-8-5 | M39012/25-0106 | Dust Cap & Nylon Cord | M | Silver | 0.700 | 0.560 | 0.144 | 4.000 | NONE | NONE | NONE | | 19 |
| 758-33-9 | | Dust Cap & Safety Chain | M | Nickel | 0.670 | 0.570 | 0.030 | 2.700 | NONE | NONE | NONE | | 19 |
| 758-36-101 | | Dust Cap & Safety Chain | M | Olive Drab | 0.700 | 0.560 | 0.050 | 2.500 | NONE | NONE | NONE | | 19 |
| KC-89-88 | M39012/25-0007 | Dust Cap & Safety Chain | M | Silver | 0.670 | 0.570 | 0.520 | 2.700 | NONE | NONE | NONE | | 19 |
| KC-89-89 | M39012/25-0008 | Dust Cap & Safety Chain | F | Silver | 0.670 | 0.520 | 0.280 | 3.250 | NONE | NONE | NONE | | N/S |
| KC-89-180 | | Dust Cap & Wire Rope | M | Silver | 0.700 | 0.560 | 0.140 | 4.000 | NONE | NONE | NONE | | 19 |
| 758-42-3 | | Dust Cap & Wire Rope | M | Stainless | 0.700 | 0.560 | 0.144 | 4.000 | NONE | NONE | NONE | | 19 |
| KC-89-93 | M39012/25-0016 | Shorting Plug & Chain | M | Silver | 0.700 | 0.550 | 0.140 | 2.250 | NONE | NONE | NONE | | 19 |
| 758-26-5 | | Shorting Plug | M | Silver | 0.700 | 0.560 | | | NONE | NONE | NONE | | 20 |
| KC-89-58 | | Dust Cap | M | Nickel | 0.640 | 0.550 | | | NONE | NONE | NONE | | 20 |
| KC-89-92 | M39012/25-0015 | Dust Cap | M | Silver | 0.580 | 0.550 | | | NONE | NONE | NONE | | 20 |
| KC-39-30 | | Jack, Conventional | F | Silver | 1.150 | 0.560 | | | B | CP-1004.1 | NONE | | 21 |
| KC-39-03 | M39012/17-0101 | Jack, Conventional | F | Silver | 1.150 | 0.560 | | | D | CP-1050 | NONE | | 21 |
| KC-79-51 | | Receptacle, Panel | M | Nickel | 1.190 | 0.760 | 0.090 | 0.560 | NONE | SOLDER | NONE | | 22 |
| UG-1104 A/U | | Receptacle, Panel | M | Silver | 1.180 | 0.760 | 0.090 | 0.560 | NONE | SOLDER | NONE | | 22 |

RECEPTACLES



FIGURE 23



FIGURE 24



FIGURE 25



FIGURE 26



FIGURE 27

| Item Number | Military PN | Product Description | Gender | Finish | Dimensions | | | | Cable Group | Cable Procedure | Crimp Die | Mounting Hole | Figure # |
|---------------|----------------|---------------------------------------|--------|--------|------------|-------|-------|-------|-------------|-----------------|-----------|---------------|----------|
| | | | | | A | B | C | D | | | | | |
| KC-79-260 M06 | | Receptacle, Panel | F | Nickel | 1.060 | 0.630 | 0.060 | 0.09 | NONE | SOLDER | NONE | | 23 |
| UG-447 /U | | Receptacle, Panel, Rexolite Insulator | F | Silver | 1.060 | 0.630 | 0.060 | 0.090 | NONE | SOLDER | NONE | | 23 |
| KC-79-109 | M39012/22-0001 | Receptacle, Panel, PTFE Insulator | F | Silver | 1.060 | 0.630 | 0.060 | 0.090 | NONE | SOLDER | NONE | | 23 |
| KC-79-125 | | Receptacle, Panel, Iso Grd | F | Nickel | 1.060 | 0.600 | 0.060 | 0.090 | NONE | SOLDER | NONE | | 23 |
| 757-29-5 | | Receptacle, Panel, Iso Grd | F | Silver | 1.060 | 0.600 | 0.060 | 0.120 | NONE | SOLDER | NONE | | 23 |
| UG-535 /U | | Receptacle, Panel, Angle | F | Silver | 1.090 | 0.720 | | | NONE | SOLDER | NONE | | 24 |
| 757-15-9 | | Receptacle, PCB, Gold Contact | F | Nickel | 0.780 | 0.560 | 0.090 | | NONE | SOLDER | NONE | | 25 |
| KC-79-215 | | Receptacle, PCB, Gold Contact | F | Nickel | 0.900 | 0.560 | 0.090 | | NONE | SOLDER | NONE | | 25 |
| KC-79-07 M06 | | Receptacle, PCB, Silver Contact | F | Nickel | 0.780 | 0.560 | 0.090 | | NONE | SOLDER | NONE | | 25 |
| KC-79-168 | | Receptacle, PCB, Gold Contact | F | Silver | 0.780 | 0.560 | 0.090 | | NONE | SOLDER | NONE | | 25 |
| KC-79-07 | | Receptacle, PCB, Silver Contact | F | Silver | 0.780 | 0.560 | 0.090 | | NONE | SOLDER | NONE | | 25 |
| KC-79-274 M06 | | Receptacle, PCB, Gold Contact | F | Nickel | 0.780 | 0.130 | | | NONE | SOLDER | NONE | | 26 |
| KC-79-237 M06 | | Receptacle, PCB, Angle | F | Nickel | 1.340 | 0.990 | | | NONE | SOLDER | NONE | | 27 |
| KC-79-237 M07 | | Receptacle, PCB, Angle | F | Silver | 1.340 | 0.990 | | | NONE | SOLDER | NONE | | 27 |

BULKHEAD RECEPTACLES



FIGURE 28

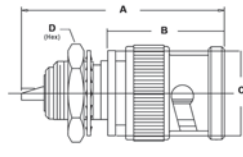

FIGURE 29



FIGURE 30

TERMINATION



FIGURE 31

| Item Number | Military PN | Product Description | Gender | Finish | Dimensions | | | | Cable Group | Cable Procedure | Crimp Die | Mounting Hole | Figure # |
|---------------|-----------------|--|--------|--------|------------|-------|-------|-------|-------------|-----------------|-----------|---------------|----------|
| | | | | | A | B | C | D | | | | | |
| KC-79-44 QD | | Receptacle, Front Mt | F | Nickel | 0.680 | 0.560 | | | NONE | SOLDER | NONE | | 28 |
| KC-79-59 | | Receptacle, Bulkhd, Front Mt | M | Nickel | 1.190 | 0.670 | 0.500 | 0.500 | NONE | SOLDER | NONE | B | 29 |
| KC-79-58 | | Receptacle, Bulkhd, Front Mt | M | Silver | 1.190 | 0.670 | 0.500 | 0.500 | NONE | SOLDER | NONE | B | 29 |
| KC-79-214 | | Receptacle, Bulkhd, Front Mt, Iso Grnd | F | Nickel | 1.080 | 0.530 | 0.630 | 0.560 | NONE | SOLDER | NONE | A | 30 |
| KC-79-131 | | Receptacle, Bulkhd, Front Mt | F | Nickel | 1.190 | 0.470 | 0.500 | 0.500 | NONE | SOLDER | NONE | B | 30 |
| KC-79-35 | | Receptacle, Bulkhd, Front Mt | F | Nickel | 1.060 | 0.470 | 0.500 | 0.500 | NONE | SOLDER | NONE | B | 30 |
| UG-1873 /U | | Receptacle, Bulkhd, Front Mt | F | Silver | 1.200 | 0.520 | 0.600 | 0.500 | NONE | SOLDER | NONE | | 30 |
| KC-79-106 | M39012/21-0002 | Receptacle, Bulkhd, Front Mt | F | Silver | 1.190 | 0.470 | 0.500 | 0.500 | NONE | SOLDER | NONE | B | 30 |
| UG-1094 /U | | Receptacle, Bulkhd, Front Mt | F | Silver | 1.060 | 0.470 | 0.500 | 0.500 | NONE | SOLDER | NONE | B | 30 |
| KC-79-200 | | Receptacle, Bulkhd, Front Mt | F | Nickel | 0.920 | 0.500 | 0.500 | 0.500 | NONE | SOLDER | NONE | C | 30 |
| KC-79-48 | | Receptacle, Bulkhd, Front Mt | F | Nickel | 1.060 | 0.470 | 0.500 | 0.500 | NONE | SOLDER | NONE | C | 30 |
| 754-21-5 | M39012/128-0001 | Receptacle, Bulkhd, Front Mt, Iso Grnd | F | Silver | 1.060 | 0.520 | 0.560 | 0.630 | NONE | SOLDER | NONE | A | 30 |
| KC-79-302 M06 | | Receptacle, Bulkhd, Front Mt, Iso Grd | F | Nickel | 1.380 | 0.630 | 0.500 | 0.500 | NONE | SOLDER | NONE | B | 30 |
| KC-79-155 | | Receptacle, Bulkhd, Front Mt, Polarized | F | Nickel | 1.250 | 0.500 | 0.060 | | NONE | SOLDER | NONE | B | 30 |
| KC-79-110 | M39012/23-0001 | Receptacle, Bulkhd, Front Mt, Angle | F | Silver | 0.910 | 1.370 | 0.610 | 1.150 | NONE | SOLDER | NONE | B | N/S |
| KC-79-111 | M39012/23-0002 | Receptacle, Bulkhd, Front Mt, Angle | F | Silver | 0.910 | 1.240 | 0.610 | 1.020 | NONE | SOLDER | NONE | D | N/S |
| KC-79-179 | | Receptacle, Bulkhd, Rear Mt | F | Nickel | 1.040 | 0.730 | 0.630 | 0.630 | NONE | SOLDER | NONE | A | N/S |
| KC-79-74 | | Receptacle, Bulkhd, Rear Mt, Hermetic | F | Nickel | 1.200 | 0.830 | 0.750 | 0.690 | NONE | SOLDER | NONE | A | N/S |
| KC-79-107 | M39012/24-0001 | Receptacle, Bulkhd, Rear Mt, Hermetic | F | Silver | 1.200 | 0.830 | 0.630 | 0.690 | NONE | SOLDER | NONE | A | N/S |
| KC-79-150 | | Receptacle, Bulkhd, Rear Mt, Iso Grnd | F | Nickel | 1.060 | 0.730 | 0.560 | 0.560 | NONE | SOLDER | NONE | A | N/S |
| KC-79-105 | M39012/21-0001 | Receptacle, Bulkhd, Front Mt | F | Silver | 1.060 | 0.470 | 0.500 | 0.500 | NONE | SOLDER | NONE | D | 30 |
| KC-79-108 M06 | | Receptacle, Bulkhd, Front Mt, Hermetic | F | Nickel | 1.200 | 0.530 | 0.500 | 0.590 | NONE | SOLDER | NONE | B | 30 |
| KC-79-108 | M39012/24-0002 | Receptacle, Bulkhd, Front Mt, Hermetic | F | Silver | 1.200 | 0.520 | 0.500 | 0.590 | NONE | SOLDER | NONE | B | 30 |
| KC-79-197 | | Receptacle, Bulkhd, Front Mt, Iso Grnd, Gold Contact | F | Nickel | 1.060 | 0.530 | 0.560 | 0.630 | NONE | SOLDER | NONE | A | 30 |
| KC-79-67 QD | | Receptacle, Bulkhd, Front Mt, Iso Grnd, Silver Contact | F | Nickel | 1.060 | 0.480 | 0.560 | 0.630 | NONE | SOLDER | NONE | A | 30 |
| 1345-3-31 | | Termination, 50 Ohm, 1%, 1/2 Watt, Gold Contact | M | Nickel | 1.000 | 0.560 | | | NONE | NONE | NONE | | 31 |
| KC-89-64 | | Termination, 50 Ohm, 1%, 1/2 Watt, Silver Contact | M | Nickel | 1.440 | 0.560 | | | NONE | NONE | NONE | | 31 |
| 1345-4-31 | | Termination, 50 Ohm, 1%, 1/2 Watt, w/Chain | M | Nickel | 1.000 | 0.560 | | | NONE | NONE | NONE | | N/S |
| KC-89-42 | | Termination, 50 Ohm, 1%, 1/2 Watt, w/Chain | M | Silver | 1.520 | 0.560 | | | NONE | NONE | NONE | | N/S |
| KC-89-103 | | Termination, 50 Ohm, 5%, 1/2 Watt | M | Nickel | 1.190 | 0.560 | | | NONE | NONE | NONE | | 31 |
| 1340-1 | | Termination, 50 Ohm, 5%, 2 Watt | M-F | Nickel | 1.360 | 0.560 | | | NONE | NONE | NONE | | N/S |
| KC-89-163 | | Termination, 50 Ohm, 5%, 2 Watt | M | Nickel | 1.420 | 0.560 | | | NONE | NONE | NONE | | 31 |

ADAPTERS - WITHIN SERIES



FIGURE 32

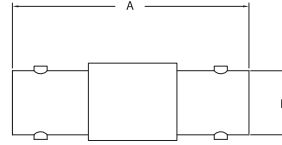

FIGURE 33

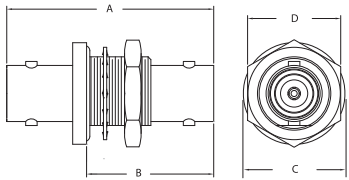

FIGURE 34

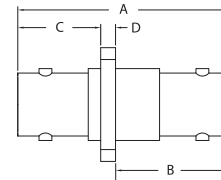

FIGURE 35

| Item Number | Military PN | Product Description | Gender | Finish | Dimensions | | | | Cable Group | Cable Procedure | Crimp Die | Mounting Hole | Figure # |
|--------------|-----------------|--------------------------------------|--------|--------|------------|-------|-------|-------|-------------|-----------------|-----------|---------------|----------|
| | | | | | A | B | C | D | | | | | |
| KC-99-32 | | Adapter, Plug-Plug | M-M | Nickel | 1.220 | 0.560 | | | NONE | NONE | NONE | | 32 |
| 759-5 | M55339/15-00491 | Adapter, Plug-Plug | M-M | Silver | 1.230 | 0.570 | | | NONE | NONE | NONE | | 32 |
| KC-99-30 | | Adapter, Jack-Jack | F-F | Nickel | 1.280 | 0.440 | | | NONE | NONE | NONE | | 33 |
| 759-1 | M55339/16-00914 | Adapter, Jack-Jack | F-F | Silver | 1.280 | 0.440 | | | NONE | NONE | NONE | | 33 |
| KC-99-95 M06 | | Adapter, Bulkhd, Jack-Jack | F-F | Nickel | 1.280 | 0.730 | 0.680 | 0.630 | NONE | NONE | NONE | A | 34 |
| 759-9 | M55339/13-00001 | Adapter, Bulkhd, Jack-Jack | F-F | Silver | 1.400 | 0.860 | 0.630 | 0.630 | NONE | NONE | NONE | A | 34 |
| KC-99-38 | | Adapter, Bulkhd, Hermetic, Jack-Jack | F-F | Nickel | 1.530 | 0.860 | 0.690 | 0.750 | NONE | NONE | NONE | A | 34 |
| 759-2 | M55339/13-00492 | Adapter, Bulkhd, Hermetic, Jack-Jack | F-F | Silver | 1.530 | 0.860 | 0.690 | 0.630 | NONE | NONE | NONE | A | 34 |
| KC-99-54 | | Adapter, Bulkhd, Iso Grd, Jack-Jack | F-F | Nickel | 1.280 | 0.800 | 0.630 | 0.630 | NONE | NONE | NONE | A | 34 |
| KC-99-40 | | Adapter, Bulkhd, Iso Grd, Jack-Jack | F-F | Silver | 1.280 | 0.800 | 0.630 | 0.630 | NONE | NONE | NONE | A | 34 |
| KC-99-56 | | Adapter, Panel, Jack-Jack | F-F | Nickel | 1.280 | 0.500 | 0.440 | 0.090 | NONE | NONE | NONE | | 35 |

ADAPTERS - WITHIN SERIES

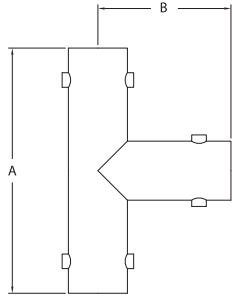

FIGURE 36

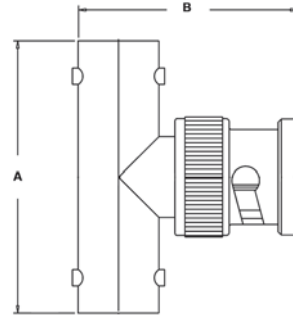

FIGURE 37

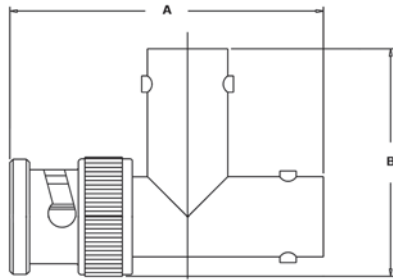

FIGURE 38

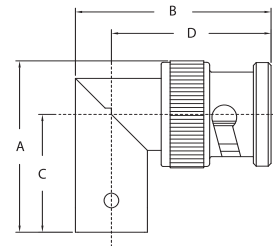

FIGURE 39

| Item Number | Military PN | Product Description | Gender | Finish | Dimensions | | | | Cable Group | Cable Procedure | Crimp Die | Mounting Hole | Figure # |
|---------------|-----------------|--|--------|--------|------------|-------|-------|-------|-------------|-----------------|-----------|---------------|----------|
| | | | | | A | B | C | D | | | | | |
| KC-99-37 | | Adapter, Tee, Jack-Jack-Jack | F-F-F | Nickel | 1.281 | 0.703 | | | NONE | NONE | NONE | | 36 |
| KC-99-20 | | Adapter, Tee, Jack-Jack-Jack | F-F-F | Silver | 1.280 | 0.700 | | | NONE | NONE | NONE | | 36 |
| 759-3 | M55339/17-00274 | Adapter, Tee, Jack-Plug-Jack | F-M-F | Silver | 1.280 | 1.060 | | | NONE | NONE | NONE | | 37 |
| KC-99-52 | | Adapter, Tee, Jack-Plug-Jack, Gold Contact | F-M-F | Nickel | 1.280 | 1.060 | | | NONE | NONE | NONE | | 37 |
| KC-99-31 | | Adapter, Tee, Jack-Plug-Jack, Silver Contact | F-M-F | Nickel | 1.280 | 1.060 | | | NONE | NONE | NONE | | 37 |
| KC-99-108 M06 | | Adapter, Tee, Plug-Jack-Jack, Gold Contact | M-F-F | Nickel | 1.480 | 0.980 | | | NONE | NONE | NONE | | 38 |
| KC-99-53 | | Adapter, Tee, Plug-Jack-Jack, Silver Contact | M-F-F | Nickel | 1.480 | 0.980 | | | NONE | NONE | NONE | | 38 |
| KC-99-35 | | Adapter, Angle, Jack-Plug | F-M | Nickel | 0.900 | 1.030 | 0.620 | 0.840 | NONE | NONE | NONE | | 39 |
| 759-4 | M55339/14-00306 | Adapter, Angle, Jack-Plug | F-M | Silver | 0.900 | 1.030 | 0.720 | 0.850 | NONE | NONE | NONE | | 39 |



SPECIFICATIONS

MATERIAL

| | |
|------------------|---------------------------------------|
| Body: | Brass |
| Crimp Sleeves: | Annealed Copper Alloy |
| Center Contacts: | Brass (Male) Copper Alloy (Female) |
| Outer Contacts: | Beryllium Copper |
| Insulators: | PTFE |
| Gaskets & Seals: | Silicone Rubber |

FINISHES

| | |
|------------------|------|
| Body: | Gold |
| Center Contacts: | Gold |

ELECTRICAL

| | |
|------------------------|--|
| Impedance: | 50 Ohms |
| Frequency Range: | DC to 18 GHz |
| Insulation Resistance: | 5,000 Megaohms Minimum |
| Contact Resistance: | 2.0 Milliohms Maximum |
| VSWR: | RG-402 1.02 + .005f (GHz) RG-405 1.02 + .008f (GHz) |

- 50 Ohm Nominal Impedance.
- Blind mate design.
- Slide-on, non-locking interface allows multiple connectors to be mated simultaneously.
- Hot-mateable, can be mated while power is on.
- Designed to the interface dimensions of MIL-STD-348.
- Frequency Range: DC to 18 GHz

MECHANICAL

| | |
|---------------------------|--|
| Life: | 500 Cycles |
| Insertion Force: | 3.0 Pounds Maximum |
| Withdrawal Force: | 0.5 Pounds Minimum |
| Center Contact Retention: | 6.0 Pounds Minimum |
| Allowable Misalignment: | 0.020" Radial, 0.060" Axial (Float Mount) 0.008" Radial, 0.015" Axial (Rigid Mount) |

ENVIRONMENTAL

| | |
|----------------------|--------------------------------------|
| Temperature Range: | -65° C to +125° C |
| Vibration: | MIL-STD-202, Method 204, Condition D |
| Shock: | MIL-STD-202, Method 213, Condition I |
| Corrosion: | MIL-STD-202, Method 101, Condition B |
| Moisture Resistance: | MIL-STD-202, Method 106 |

INTERFACE DIMENSIONS

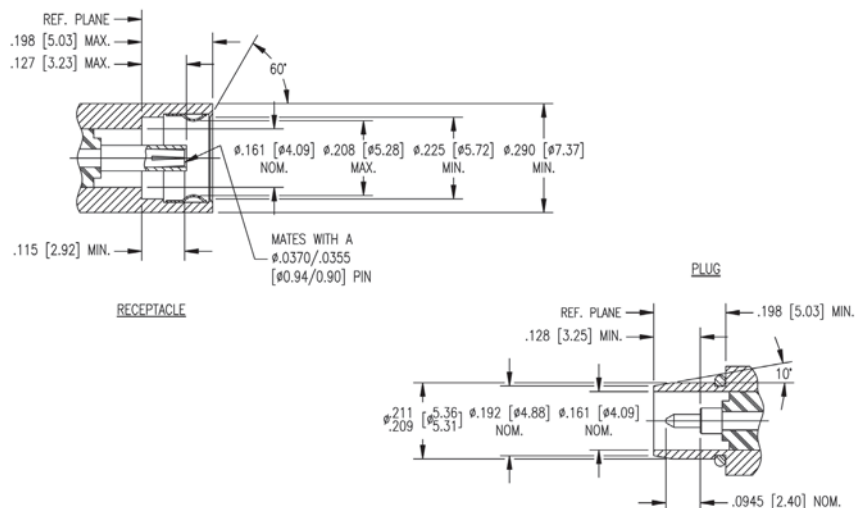

CABLE JACKS, CRIMP TYPE - FLEXIBLE CABLE

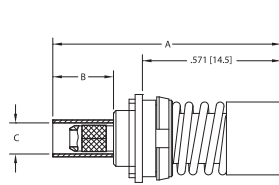

FIGURE 1

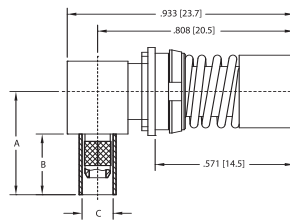

FIGURE 2



FIGURE 3



FIGURE 4

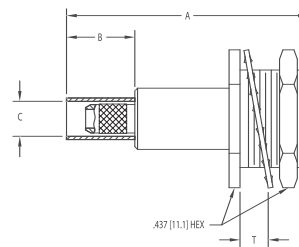

FIGURE 5

CABLE PLUGS, CRIMP TYPE - FLEXIBLE CABLE

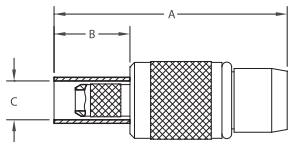

FIGURE 6



FIGURE 7



FIGURE 8

| Item Number | Military PN | Product Description | Gender | Finish | Dimensions | | | | Cable Group | Cable Procedure | Crimp Die | Mounting Hole | Figure # |
|---------------|-------------|------------------------------|--------|--------|------------|-------|-------|-------|-------------|-----------------|-----------|---------------|----------|
| | | | | | A | B | C | T | | | | | |
| 361-922-0630H | | Jack, Floating, Crimp | F | Gold | 0.940 | 0.250 | 0.128 | | B | CAP9-11 | KTH-2011 | A | 1 |
| 363-922-0630H | | Jack, Angle, Floating, Crimp | F | Gold | 0.425 | 0.250 | 0.128 | | B | CAP9-12 | KTH-2011 | A | 2 |
| 361-994-0630H | | Jack, Floating, Crimp | F | Gold | 0.922 | 0.250 | 0.128 | 0.125 | B | CAP9-11 | KTH-2011 | F | 3 |
| 361-900-0630H | | Jack, Crimp | F | Gold | 0.880 | 0.250 | 0.128 | | B | CAP9-11 | KTH-2011 | | 4 |
| 361-995-0630H | | Jack, Bulkhead, Crimp | F | Gold | 0.885 | 0.250 | 0.128 | 0.125 | B | CAP9-11 | KTH-2011 | G | 5 |
| 360-900-0630H | | Plug, Crimp | M | Gold | 0.768 | 0.250 | 0.128 | | B | CAP9-11 | KTH-2011 | | 6 |
| 360-974-0630H | | Plug, Bulkhead, Crimp | M | Gold | 0.762 | 0.250 | 0.128 | 0.125 | B | CAP9-11 | KTH-2011 | E | 7 |
| 362-974-0630H | | Plug, Angle, Bulkhead, Crimp | M | Gold | 0.425 | 0.250 | 0.128 | 0.125 | B | CAP9-12 | KTH-2011 | E | 8 |

CABLE JACKS, SOLDER TYPE - SEMI-RIGID CABLE



FIGURE 9

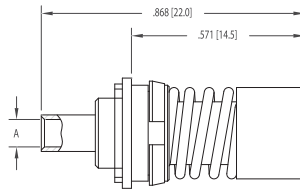

FIGURE 10



FIGURE 11

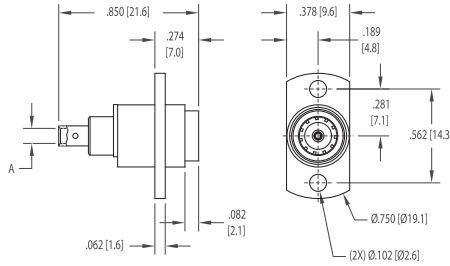

FIGURE 12

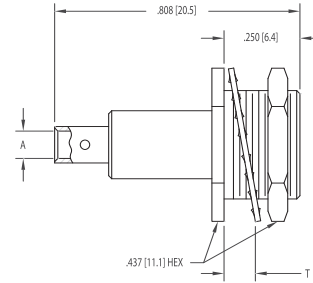

FIGURE 13

CABLE PLUGS, SOLDER TYPE - SEMI-RIGID CABLE

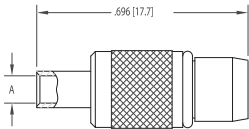

FIGURE 14

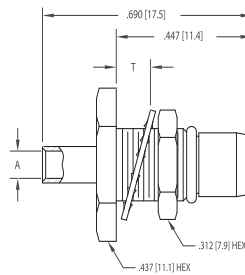

FIGURE 15

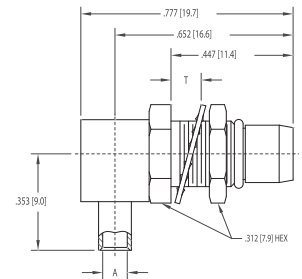

FIGURE 16

| Item Number | Military PN | Product Description | Gender | Finish | Dimensions | | | | Cable Group | Cable Procedure | Crimp Die | Mounting Hole | Figure # |
|---------------|-------------|-------------------------------|--------|--------|------------|---|---|-------|-------------|-----------------|-----------|---------------|----------|
| | | | | | A | B | C | T | | | | | |
| 361-500-1410H | | Jack, Solder | F | Gold | 0.145 | | | | 49 | CAP5-24 | | | 9 |
| 361-500-0850H | | Jack, Solder | F | Gold | 0.090 | | | | 50 | CAP5-24 | | | 9 |
| 361-522-1410H | | Jack, Floating, Solder | F | Gold | 0.145 | | | | 49 | CAP5-24 | A | | 10 |
| 361-522-0850H | | Jack, Floating, Solder | F | Gold | 0.090 | | | | 50 | CAP5-24 | A | | 10 |
| 363-522-1410H | | Jack, Angle, Floating, Solder | F | Gold | 0.145 | | | | 49 | CAP5-25 | A | | 11 |
| 363-522-0850H | | Jack, Angle, Floating, Solder | F | Gold | 0.090 | | | | 50 | CAP5-25 | A | | 11 |
| 361-594-1410H | | Jack, Floating, Solder | F | Gold | 0.145 | | | 0.125 | 49 | CAP5-24 | F | | 12 |
| 361-594-0850H | | Jack, Floating, Solder | F | Gold | 0.090 | | | 0.125 | 50 | CAP5-24 | F | | 12 |
| 361-595-1410H | | Jack, Bulkhead, Solder | F | Gold | 0.145 | | | 0.125 | 49 | CAP5-24 | G | | 13 |
| 361-595-0850H | | Jack, Bulkhead, Solder | F | Gold | 0.090 | | | 0.125 | 50 | CAP5-24 | G | | 13 |
| 360-500-1410H | | Plug, Solder | M | Gold | 0.145 | | | | 49 | CAP5-24 | | | 14 |
| 360-500-0850H | | Plug, Solder | M | Gold | 0.090 | | | | 50 | CAP5-24 | | | 14 |
| 360-574-1410H | | Plug, Bulkhead, Solder | M | Gold | 0.145 | | | 0.125 | 49 | CAP5-24 | E | | 15 |
| 360-574-0850H | | Plug, Bulkhead, Solder | M | Gold | 0.090 | | | 0.125 | 50 | CAP5-24 | E | | 15 |
| 362-574-1410H | | Plug, Angle, Bulkhead, Solder | M | Gold | 0.145 | | | 0.125 | 49 | CAP5-25 | E | | 16 |
| 362-574-0850H | | Plug, Angle, Bulkhead, Solder | M | Gold | 0.090 | | | 0.125 | 50 | CAP5-25 | E | | 16 |

PCB PLUGS



FIGURE 17

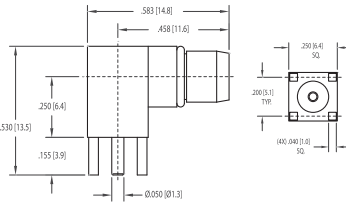

FIGURE 18



FIGURE 19

PCB JACKS

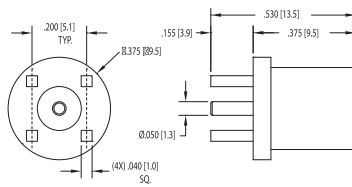

FIGURE 20

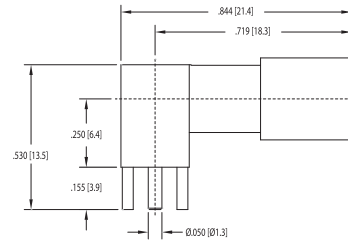

FIGURE 21

PANEL PLUGS

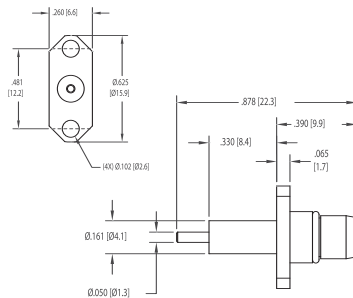

FIGURE 22_1

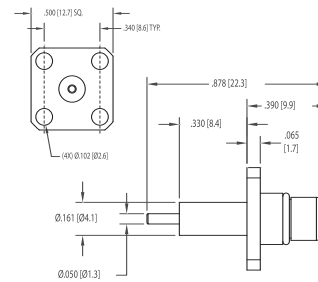

FIGURE 22_2

PANEL JACKS

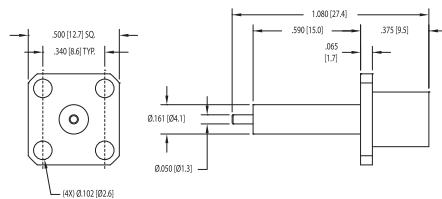

FIGURE 23_1

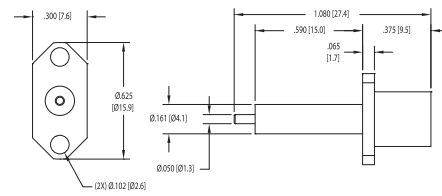

FIGURE 23_2

| Item Number | Military PN | Product Description | Gender | Finish | Dimensions | | | | Cable Group | Cable Procedure | Crimp Die | Mounting Hole | Figure # |
|---------------|-------------|----------------------------|--------|--------|------------|---|---|-------|-------------|-----------------|-----------|---------------|----------|
| | | | | | A | B | C | T | | | | | |
| 360-060-0040H | | Plug, PWB | M | Gold | | | | | | | B | 17 | |
| 362-060-0040H | | Plug, Angle, PWB | M | Gold | | | | | | | B | 18 | |
| 362-074-6040H | | Plug, Angle, Bulkhead, PWB | M | Gold | | | | 0.125 | | | B & E | 19 | |
| 361-060-0040H | | Jack, PWB | F | Gold | | | | | | | B | 20 | |
| 363-060-0040H | | Jack, Angle, PWB | F | Gold | | | | | | | B | 21 | |
| 360-066-0040H | | Receptacle, Panel | M | Gold | | | | | | | D | 22_1 | |
| 360-065-0040H | | Receptacle, Panel | M | Gold | | | | | | | C | 22_2 | |
| 361-065-0040H | | Receptacle, Panel | F | Gold | | | | | | | C | 23_1 | |
| 361-066-0040H | | Receptacle, Panel | F | Gold | | | | | | | D | 23_2 | |

C SERIES



SPECIFICATIONS

MATERIAL

| | |
|------------------|---|
| Body: | Brass |
| Crimp Sleeves: | Commercial Bronze Alloy |
| Center Contacts: | Brass (Male) Beryllium Copper (Female) |
| Outer Contacts: | Beryllium Copper (Male) |
| Insulators: | PTFE |
| Gaskets & Seals: | Silicone Rubber |

FINISHES

| | |
|------------------|------------------|
| Body: | Silver or Nickel |
| Center Contacts: | Gold or Silver |

ELECTRICAL

| | |
|------------------|------------------------|
| Impedance: | 50 Ohms |
| Frequency Range: | DC to 11 GHz |
| Voltage Rating: | 1000 Volts RMS |
| VSWR: | 1.35 Max, DC to 11 GHz |
| Insertion Loss: | .15 dB Max at 9 GHz |

- 50 Ohm Nominal Impedance.
- Standard size connector with bayonet coupling.
- Durable brass bodies with Silver or Nickel plating.
- Overlapping dielectric interface with weatherproof features.
- Commercial and Military-Specified versions available.
- Frequency Range: Up to 11 GHz

MECHANICAL

| | |
|------------------|-------------------|
| Life: | 500 Cycles |
| Cable Retention: | 50 Pounds Minimum |

ENVIRONMENTAL

| | |
|----------------------|--------------------------------------|
| Temperature Range: | -65° C to +165° C |
| Vibration: | MIL-STD-202, Method 204, Condition B |
| Shock: | MIL-STD-202, Method 213, Condition I |
| Corrosion: | MIL-STD-202, Method 101, Condition B |
| Moisture Resistance: | MIL-STD-202, Method 106 |

INTERFACE DIMENSIONS

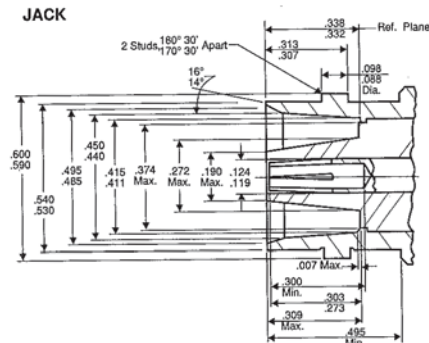
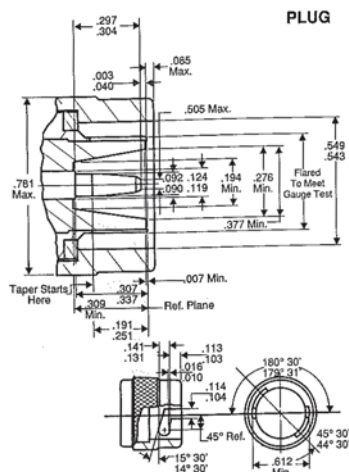

ANGLE PLUG - CONVENTIONAL

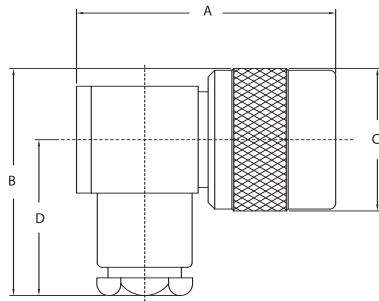

FIGURE 1

ANGLE PLUG - K-GRIP

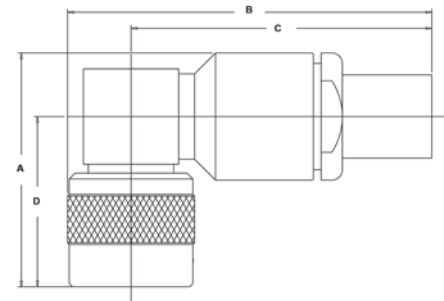

FIGURE 2

ANGLE PLUG - K-GRIP, JR.



FIGURE 3

ADAPTER - WITHIN SERIES

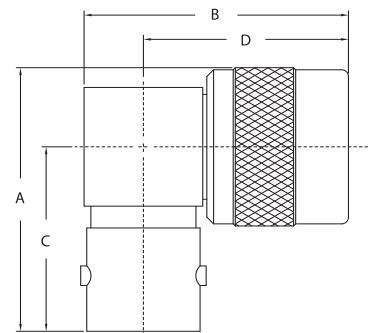

FIGURE 4

| Item Number | Military PN | Product Description | Gender | Finish | Dimensions | | | | Cable Group | Cable Procedure | Crimp Die | Mounting Hole | Figure # |
|---------------|-----------------|----------------------------------|--------|--------|------------|-------|-------|-------|-------------|-----------------|-----------|---------------|----------|
| | | | | | A | B | C | D | | | | | |
| KD-59-47 | | Plug, Angle, Conventional | M | Silver | 1.330 | 1.200 | 0.750 | 0.820 | DE | CP-1025 | | | 1 |
| KD-59-84 | | Plug, Angle, Conventional | M | Nickel | 1.350 | 1.620 | 0.750 | 0.970 | MN | CP-1030 | | | 1 |
| KD-59-134 | M39012/10-0001 | Plug, Angle, Conventional | M | Silver | 1.360 | 1.640 | 0.780 | 1.260 | N1 | D-59-134-5 | | | 1 |
| KD-59-26 | | Plug, Angle, Crimp | M | Silver | 1.350 | 2.110 | 1.740 | 0.970 | E1 | CP-5406 | KTH-2004 | | 2 |
| KD-59-110 | | Plug, Angle, Crimp, Weatherproof | M | Nickel | 1.270 | 2.160 | 1.780 | 0.970 | 2 | CP-5402 | KTH-1079 | | 3 |
| KD-59-126 | | Plug, Angle, Crimp, Weatherproof | M | Nickel | 1.300 | 2.080 | 1.720 | 0.970 | 45 | CP-5406 | KTH-2103 | | 3 |
| KD-59-187 M06 | | Plug, Angle, Crimp, Weatherproof | M | Nickel | 1.270 | 1.910 | 1.540 | 0.970 | 12 | CP-5402 | KTH-2127 | | 3 |
| 796-15-9 | | Plug, Angle, Crimp, Weatherproof | M | Nickel | 1.300 | 2.090 | 1.710 | 0.970 | 16 | 3-546-2 | KTH-2211 | | 3 |
| 796-17-9 | | Plug, Angle, Crimp, Weatherproof | M | Nickel | 1.300 | 2.050 | 1.670 | 0.970 | 17 | 3-546-2 | KTH-2231 | | 3 |
| 796-18-9 | | Plug, Angle, Crimp, Weatherproof | M | Nickel | 1.300 | 2.150 | 1.770 | 0.970 | 18 | 3-546-2 | KTH-2212 | | 3 |
| KD-59-110 M07 | | Plug, Angle, Crimp, Weatherproof | M | Silver | 1.270 | 2.000 | 1.630 | 0.970 | 2 | CP-5402 | KTH-1079 | | 3 |
| 796-11-9 | | Plug, Angle, Crimp, Weatherproof | M | Nickel | 1.300 | 2.340 | 1.960 | 0.970 | 9 | 3-440-2 | KTH-2062 | | 3 |
| KD-59-129 | | Plug, Angle, Crimp, Weatherproof | M | Nickel | 1.300 | 2.110 | 1.740 | 0.970 | D | CP-5406 | KTH-2101 | | 3 |
| KD-59-202 M06 | | Plug, Angle, Crimp, Weatherproof | M | Nickel | 1.300 | 2.110 | 1.740 | 0.970 | E | CP-5406 | KTH-2101 | | 3 |
| KD-59-193 M06 | | Plug, Angle, Crimp, Weatherproof | M | Nickel | 1.270 | 2.000 | 1.630 | 0.970 | N3 | S-89-24-6 | KTH-2105 | | 3 |
| 799-5 | M55339/10-00567 | Adapter, Angle | M-F | Silver | 1.250 | 1.270 | 0.880 | 0.970 | | | | | 4 |
| 798-7-9 | | Dust Cap | M | Nickel | 0.685 | 0.781 | | | | | | | N/S |
| KD-89-08 | M39012/25-0002 | Dust Cap & Safety Chain | M | Silver | 0.910 | 0.750 | 3.500 | | | | | | N/S |

PLUGS - CONVENTIONAL



FIGURE 5



FIGURE 6

PLUGS - K-GRIP, JR.

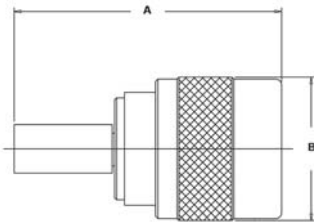

FIGURE 7



FIGURE 8

| Item Number | Military PN | Product Description | Gender | Finish | Dimensions | | | | Cable Group | Cable Procedure | Crimp Die | Mounting Hole | Figure # |
|---------------|----------------|---------------------------|--------|--------|------------|-------|-------|---|-------------|-----------------|-----------|---------------|----------|
| | | | | | A | B | C | D | | | | | |
| KD-59-130 | M39012/15-0002 | Plug, Conventional | M | Silver | 1.340 | 0.500 | 0.750 | | DE | CP-1015 | | | 5 |
| KD-59-135 | M39012/15-0001 | Plug, Conventional | M | Silver | 1.360 | 0.500 | 0.750 | | G1 | CP-1013-3 | | | 5 |
| KD-59-132 | M39012/16-0001 | Plug, Conventional | M | Silver | 1.300 | 0.750 | 0.750 | | K1 | CP-1022 | | | 5 |
| 795-10-5 | M39012/06-0014 | Plug, Conventional | M | Silver | 1.470 | 0.750 | 0.750 | | K1 | CP-1016 | | | 5 |
| KD-59-119 | M39012/06-0002 | Plug, Conventional | M | Silver | 1.470 | 0.750 | 0.750 | | MN | CP-1022 | | | 5 |
| 795-9-5 | M39012/06-0015 | Plug, Conventional | M | Silver | 1.450 | 0.750 | 0.750 | | N1 | CP-1016 | | | 5 |
| KD-59-133 | M39012/06-0003 | Plug, Conventional | M | Silver | 1.630 | 0.880 | 0.750 | | R | CP-1040 | | | 5 |
| UG-943 B/U | | Plug, Conventional | M | Silver | 2.130 | 0.750 | 0.750 | | U | CP-1040 | | | 6 |
| KD-59-63 | | Plug, Crimp | M | Silver | 1.400 | 0.750 | | | E1 | CP-403 | KTH-2001 | | 7 |
| KD-59-125 | | Plug, Crimp, Weatherproof | M | Nickel | 1.630 | 0.750 | | | 45 | CP-5406 | KTH-2103 | | 8 |
| KD-59-186 M06 | | Plug, Crimp, Weatherproof | M | Nickel | 1.500 | 0.750 | | | 12 | CP-5402 | KTH-2127 | | 8 |
| 795-15-9 | | Plug, Crimp, Weatherproof | M | Nickel | 1.615 | 0.781 | | | 16 | 3-546-2 | KTH-2211 | | 8 |
| 795-21-9 | | Plug, Crimp, Weatherproof | M | Nickel | 1.660 | 0.781 | | | 17 | 3-546-2 | KTH-2231 | | 8 |
| 795-16-9 | | Plug, Crimp, Weatherproof | M | Nickel | 1.400 | 0.781 | | | 18 | 3-546-2 | KTH-2212 | | 8 |
| 795-23-9 | | Plug, Crimp, Weatherproof | M | Nickel | 1.500 | 0.781 | | | 18 | 3-546-2 | KTH-2213 | | 8 |
| KD-59-164 | | Plug, Crimp, Weatherproof | M | Nickel | 1.500 | 0.750 | | | 2 | CP-5402 | KTH-1079 | | 8 |
| 795-20-9 | | Plug, Crimp, Weatherproof | M | Nickel | 1.800 | 0.781 | | | 20 | 3-546-2 | KTH-2229 | | 8 |
| 795-13-9 | | Plug, Crimp, Weatherproof | M | Nickel | 1.310 | 0.750 | | | 9 | 3-440-2 | KTH-2062 | | 8 |
| KD-59-161 | | Plug, Crimp, Weatherproof | M | Nickel | 1.660 | 0.750 | | | D | CP-5406 | KTH-2101 | | 8 |
| KD-59-201 M06 | | Plug, Crimp, Weatherproof | M | Nickel | 1.660 | 0.750 | | | E1 | CP-5406 | KTH-2101 | | 8 |
| 795-30-9 | | Plug, Crimp, Weatherproof | M | Nickel | 1.500 | 0.750 | | | E1 | CP-5402 | KTH-2105 | | 8 |
| KD-59-180 M06 | | Plug, Crimp, Weatherproof | M | Nickel | 1.500 | 0.750 | | | N3 | CP-5402 | KTH-2105 | | 8 |

BULKHEAD JACKS - CONVENTIONAL

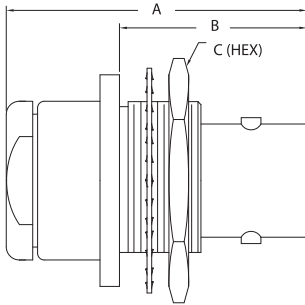

FIGURE 9

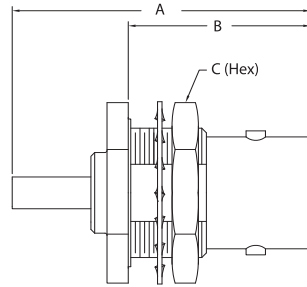

FIGURE 10



FIGURE 11

PANEL RECEPTACLE



FIGURE 12

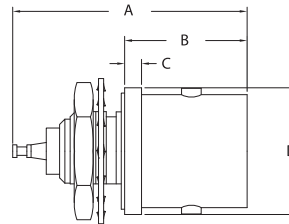

FIGURE 13



FIGURE 14

BULKHEAD RECEPTACLES

| Item Number | Military PN | Product Description | Gender | Finish | Dimensions | | | | Cable Group | Cable Procedure | Crimp Die | Mounting Hole | Figure # |
|---------------|----------------|---|--------|--------|------------|-------|-------|-------|-------------|-----------------|-----------|---------------|----------|
| | | | | | A | B | C | D | | | | | |
| KD-19-65 | M39012/09-0002 | Jack, Bulkhd, Conventional, Front Mt. | F | Silver | 1.270 | 0.590 | | | DE | 704C-1 | | I | N/S |
| KD-19-61 | M39012/11-0001 | Jack, Bulkhd, Conventional, Rear Mt. | F | Silver | 1.420 | 0.890 | | | K | 573C-1 | | J | 9 |
| KD-19-73 | M39012/11-0002 | Jack, Bulkhd, Conventional, Rear Mt. | F | Silver | 1.420 | 0.890 | | | MN | 573C-1 | | I | 9 |
| KD-19-72 | M39012/08-0001 | Jack, Panel, Conventional | F | Silver | 1.375 | 0.688 | 0.078 | 0.630 | MN | CP-1002 | | | N/S |
| KD-19-110 | | Jack, Bulkhd, Crimp, Rear Mt. | F | Silver | 1.500 | 0.860 | 0.880 | | B2 | CP-5458 | KTH-2021 | I | 10 |
| KD-19-93 | | Jack, Bulkhd, Crimp, Rear Mt. | F | Silver | 1.470 | 0.750 | | | D | CP-412 | KTH-2001 | J | 10 |
| KD-19-101 | | Jack, Bulkhd, Crimp, Rear Mt. | F | Silver | 1.810 | 0.890 | | | N | CP-480 | KTH-2004 | J | 10 |
| KD-19-69 | | Jack, Panel, Crimp, Weatherproof | F | Nickel | 1.390 | 0.490 | 0.080 | 0.500 | 45 | CP-5406 | KTH-2103 | | 11 |
| KD-19-105 M06 | | Jack, Panel, Crimp, Weatherproof | F | Nickel | 1.510 | 0.690 | 0.080 | 0.620 | 12 | CP-5402 | KTH-2127 | | 11 |
| 791-9-9 | | Jack, Panel, Crimp, Weatherproof | F | Nickel | 1.360 | 0.690 | 0.080 | 0.620 | 16 | 3-546-2 | KTH-2211 | | 11 |
| 791-8-9 | | Jack, Panel, Crimp, Weatherproof | F | Nickel | 1.390 | 0.690 | 0.080 | 0.620 | 17 | 3-546-2 | KTH-2231 | | 11 |
| 791-6-9 | | Jack, Panel, Crimp, Weatherproof | F | Nickel | 1.410 | 0.690 | 0.080 | 0.620 | 18 | 3-546-2 | KTH-2212 | | 11 |
| KD-19-66 | | Jack, Panel, Crimp, Weatherproof | F | Nickel | 1.510 | 0.690 | 0.080 | 0.620 | 2 | CP-5402 | KTH-1079 | | 11 |
| KD-19-68 | | Jack, Panel, Crimp, Weatherproof | F | Nickel | 1.390 | 0.530 | 0.080 | 0.500 | D | CP-5406 | KTH-2101 | | 11 |
| KD-19-67 | | Jack, Panel, Crimp, Weatherproof | F | Nickel | 1.390 | 0.490 | 0.080 | 0.500 | E1 | CP-5406 | KTH-2101 | | 11 |
| KD-19-104 M06 | | Jack, Panel, Crimp, Weatherproof | F | Nickel | 1.510 | 0.690 | 0.080 | 0.620 | N3 | CP-5402 | KTH-2105 | | 11 |
| 791-10-9 | | Jack, Panel, Crimp, Locking Thread, W/P | F | Nickel | 1.410 | 0.690 | 0.080 | 0.620 | 18 | 3-546-2 | KTH-2212 | | 11 |
| KD-79-19 | | Receptacle, Panel | F | Nickel | 1.080 | 0.670 | 0.080 | | | SOLDER | | | 12 |
| KD-79-14 | M39012/12-0001 | Receptacle, Panel | F | Silver | 1.080 | 0.670 | 0.080 | | | SOLDER | | | 12 |
| 794-3-9 | | Receptacle, Bulkhd, Front Mt | F | Nickel | 1.110 | 0.580 | 0.080 | 0.690 | | SOLDER | | H | 13 |
| KD-79-13 | M39012/13-0001 | Receptacle, Bulkhd, Front Mt | F | Silver | 1.110 | 0.580 | 0.800 | 0.600 | | SOLDER | | H | 13 |
| 794-4-9 | | Receptacle, Bulkhd, Rear Mt | F | Silver | 1.310 | | | 1.000 | | SOLDER | | J | 14 |



- 50 Ohm Nominal Impedance.
- Positive-lock coupling mechanism.
- Designed to replace BNC connectors in high-density applications.
- Small & lightweight.
- Interchangeable with equivalent Lemo® type connectors.

SPECIFICATIONS

MATERIAL

| | |
|------------------|---|
| Body: | Brass or Beryllium Copper |
| Crimp Sleeves: | Commercial Bronze Alloy |
| Center Contacts: | Brass or Beryllium Copper (Male) Beryllium Copper (Female) |
| Outer Contacts: | Beryllium Copper (Male) |
| Insulators: | PTFE |

FINISHES

| | |
|------------------|--------|
| Body: | Nickel |
| Center Contacts: | Gold |

ELECTRICAL

| | |
|------------------------|---------------|
| Impedance: | 50 Ohms |
| Voltage Rating: | 500 Volts RMS |
| Insulation Resistance: | 5000 Megohms |
| Contact Resistance: | 6 Milliohms |

MECHANICAL

| | |
|------------------|---|
| Life: | 500 Cycles |
| Cable Retention: | 10 to 40 Pounds (Depending on Cable) |

ENVIRONMENTAL

| | |
|--------------------|--------------------------------------|
| Temperature Range: | -65° C to +165° C |
| Corrosion: | MIL-STD-202, Method 101, Condition B |

INTERFACE DIMENSIONS

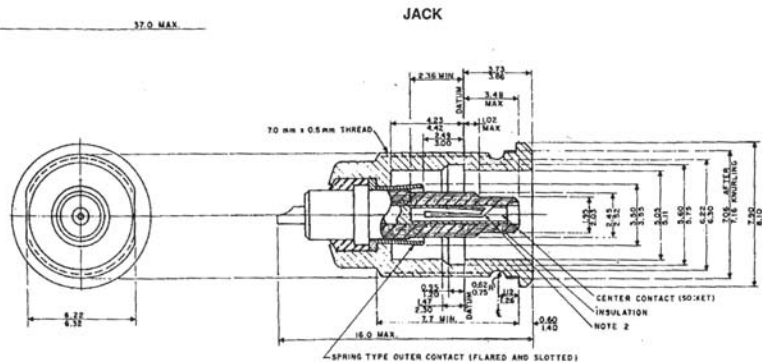
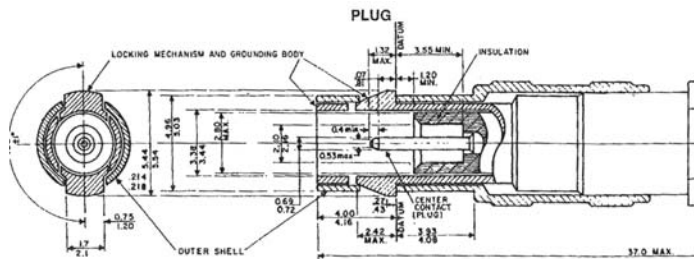

STRAIGHT PLUGS - K-GRIP, JR.



FIGURE 1



FIGURE 2

RECEPTACLES



FIGURE 3



FIGURE 4

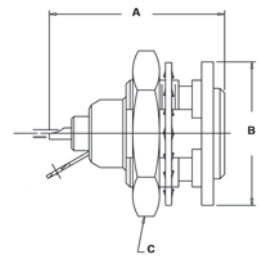

FIGURE 5

ADAPTER - WITHIN SERIES

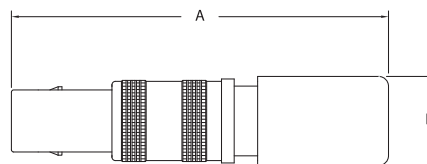

FIGURE 6

| Item Number | Military PN | Product Description | Gender | Finish | Dimensions | | | | Cable Group | Cable Procedure | Crimp Die | Mounting Hole | Figure # |
|-------------|-------------|--------------------------------|--------|--------|------------|-------|-------|-------|-------------|-----------------|-----------|---------------|----------|
| | | | | | A | B | C | D | | | | | |
| 1075-2 | | Plug, Crimp | M | Nickel | 1.440 | 0.270 | | | D | CP-458 | KTH-2027 | | 1 |
| 1075-1 | | Plug, Weatherproof Crimp | M | Nickel | 1.370 | 0.270 | | | B | CP-459 | KTH-2082 | | 2 |
| 1075-13-9 | | Plug, Weatherproof Crimp | M | Nickel | 1.430 | 0.270 | | | 16 | 3-644-1 | KTH-2232 | | 2 |
| 1074-5 | | Receptacle | F | Nickel | 0.610 | 0.310 | 0.040 | | | SOLDER | | K | 3 |
| 1074-1 QD | | Receptacle, Bulkhd, Front Mt | F | Nickel | 0.610 | 0.310 | 0.340 | | | SOLDER | | L | 4 |
| 1074-4 | | Receptacle, Bulkhd, Iso Ground | F | Nickel | 0.610 | 0.500 | 0.500 | | | SOLDER | | M | 5 |
| 1725-1 | | Termination, 50 Ohm, 1% | M | Nickel | 1.190 | 0.280 | | | | | | | 6 |
| 1079-7 | | Within Series Adapter, Bulkhd | F-F | Nickel | 0.820 | 0.400 | 0.340 | 0.040 | | | | L | N/S |



- Snap-on interface.
- 1/3 smaller than the SMB connector series.
- Available in 50 and 75 Ohm versions.
- Straight, right angle, and PCB styles available.
- Durable brass bodies with Gold or Nickel plating.
- Small & lightweight.
- Frequency Range: Up to 6 GHz

SPECIFICATIONS

MATERIAL

| | |
|------------------|---------------------------------------|
| Body: | Brass |
| Crimp Sleeves: | Annealed Copper Alloy |
| Center Contacts: | Brass (Male) Copper Alloy (Female) |
| Insulators: | PTFE |

FINISHES

| | |
|------------------|----------------|
| Body: | Gold or Nickel |
| Center Contacts: | Gold |

ELECTRICAL

| | |
|----------------------------------|-----------------------------------|
| Impedance: | 50 Ohms |
| Frequency Range: | DC to 6 GHz |
| VSWR for RG 316/U or similar: | 1.30 Maximum |
| Insertion Loss: | 0.1 dB at 1 GHz |
| Insulation Resistance: | 1,000 Megohms Minimum |
| Contact Resistance: | Center Contact: 5.0 Milliohms Max |
| Outer Contact: | 1.0 Milliohms Maximum |

MECHANICAL

| | |
|-----------------------|--|
| Life: | 500 Cycles |
| Engagement Force: | 5.6 Pounds Maximum |
| Disengagement Force: | 1.8 Pounds Minimum 4.5 Pounds Maximum |
| Contact Captivation : | 2.3 Pounds Minimum |

ENVIRONMENTAL

| | |
|--------------------|---|
| Temperature Range: | -65° C to +165° C |
| Vibration: | MIL-STD-202, Method 204, Condition B |
| Shock: | MIL-STD-202, Method 102, Condition C |
| Corrosion: | MIL-STD-202, Method 101, Condition B |

INTERFACE DIMENSIONS



CABLE PLUGS, SOLDER TYPE - SEMI-RIGID CABLE



FIGURE 1



FIGURE 2

CABLE PLUGS, CRIMP TYPE - FLEXIBLE CABLE

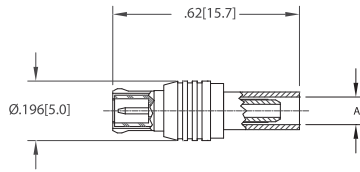

FIGURE 3

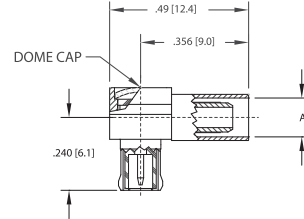

FIGURE 4

CABLE JACK, SOLDER TYPE SEMI-RIGID CABLE

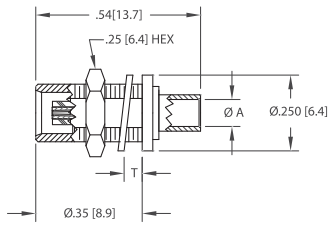

FIGURE 5

CABLE JACK, CRIMP TYPE FLEXIBLE CABLE

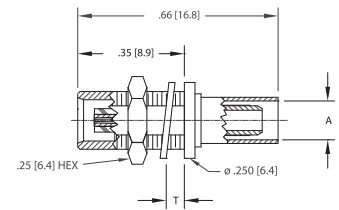

FIGURE 6

| Item Number | Military PN | Product Description | Gender | Finish | Dimensions | | | | Cable Group | Cable Procedure | Crimp Die | Mounting Hole | Figure # |
|---------------|-------------|------------------------|--------|--------|------------|---|---|-------|-------------|-----------------|-----------|---------------|----------|
| | | | | | A | B | C | T | | | | | |
| 450-500-0850H | | Plug, Solder | M | Gold | 0.090 | | | | 48 | CAP5-11 | | | 1 |
| 450-500-1410H | | Plug, Solder | M | Gold | 0.144 | | | | 49 | CAP5-11 | | | 1 |
| 450-500-0470H | | Plug, Solder | M | Gold | 0.052 | | | | 51 | CAP5-11 | | | 1 |
| 452-500-0850H | | Plug, Angle, Solder | M | Gold | 0.090 | | | | 48 | CAP5-12 | | | 2 |
| 452-500-1410H | | Plug, Angle, Solder | M | Gold | 0.144 | | | | 49 | CAP5-12 | | | 2 |
| 452-500-0470H | | Plug, Angle, Solder | M | Gold | 0.052 | | | | 51 | CAP5-12 | | | 2 |
| 450-900-0631H | | Plug, Crimp | M | Gold | 0.142 | | | | 3 | CAP9-08 | KTH-2015 | | 3 |
| 450-900-0360H | | Plug, Crimp | M | Gold | 0.091 | | | | A | CAP9-08 | KTH-2008 | | 3 |
| 450-900-0630H | | Plug, Crimp | M | Gold | 0.128 | | | | B | CAP9-08 | KTH-2011 | | 3 |
| 452-900-0631H | | Plug, Angle, Crimp | M | Gold | 0.142 | | | | 3 | CAP9-09 | KTH-2015 | | 4 |
| 452-900-0360H | | Plug, Angle, Crimp | M | Gold | 0.091 | | | | A | CAP9-09 | KTH-2008 | | 4 |
| 452-900-0630H | | Plug, Angle, Crimp | M | Gold | 0.128 | | | | B | CAP9-09 | KTH-2011 | | 4 |
| 451-580-0850H | | Jack, Bulkhead, Solder | F | Gold | 0.090 | | | 0.196 | 48 | CAP5-11 | | P | 5 |
| 451-580-1410H | | Jack, Bulkhead, Solder | F | Gold | 0.144 | | | 0.196 | 49 | CAP5-11 | | P | 5 |
| 451-580-0470H | | Jack, Bulkhead, Solder | F | Gold | 0.052 | | | 0.196 | 51 | CAP5-11 | | P | 5 |
| 451-980-0631H | | Jack, Bulkhead, Crimp | F | Gold | 0.142 | | | 0.196 | 3 | CAP9-08 | KTH-2015 | | 6 |
| 451-980-0360H | | Jack, Bulkhead, Crimp | F | Gold | 0.091 | | | 0.196 | A | CAP9-08 | KTH-2008 | | 6 |
| 451-980-0630H | | Jack, Bulkhead, Crimp | F | Gold | 0.128 | | | 0.196 | B | CAP9-08 | KTH-2011 | | 6 |

* For Nickel Plated Version, Change H to N in Part Number

PCB PLUGS

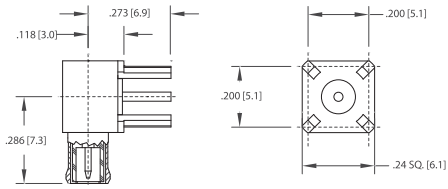

FIGURE 7



FIGURE 8

PCB JACKS

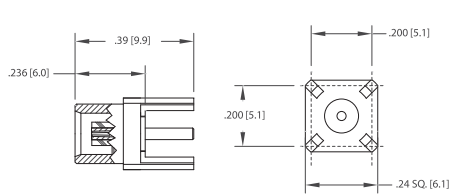

FIGURE 9



FIGURE 10_1



FIGURE 10_2

SURFACEMOUNT JACKS



FIGURE 11



FIGURE 12

| Item Number | Military PN | Product Description | Gender | Finish | Dimensions | | | | Cable Group | Cable Procedure | Crimp Die | Mounting Hole | Figure # |
|---------------|-------------|------------------------------|--------|--------|------------|---|---|---|-------------|-----------------|-----------|---------------|----------|
| | | | | | A | B | C | T | | | | | |
| 452-060-0046H | | Plug, Angle, PCB | M | Gold | | | | | | | 0 | 7 | |
| 450-060-0046H | | Plug, PCB | M | Gold | | | | | | | 0 | 8 | |
| 451-060-0046H | | Jack, PCB | F | Gold | | | | | | | 0 | 9 | |
| 453-040-0046H | | Jack, Angle, PCB | F | Gold | | | | | | | N | 10_1 | |
| 453-060-0046H | | Jack, Angle, PCB | F | Gold | | | | | | | 0 | 10_2 | |
| 451-061-0040H | | Jack, PCB, Surface Mt | F | Gold | | | | | | | | 11 | |
| 453-060-0041H | | Jack, Angle, PCB, Surface Mt | F | Gold | | | | | | | | 12 | |



- 50 Ohm Nominal Impedance.
- Snap-on interface for quick connect & disconnect.
- 1/3 smaller than the MCX series.
- Cable, right angle, and edge card styles available.
- Frequency Range: Up to 6 GHz

SPECIFICATIONS

MATERIAL

| | |
|----------------|---------------------------------------|
| Body: | Brass |
| Crimp Sleeves: | Annealed Copper Alloy |
| Contacts: | Copper Alloy (Female) Brass (Male) |
| Spring Rings: | Copper Alloy |
| Insulators: | PTFE |

FINISHES

| | |
|------------------|----------------|
| Body: | Gold or Nickel |
| Center Contacts: | Gold |

ENVIRONMENTAL

| | |
|--------------------|--------------------------------------|
| Temperature Range: | -65° C to +165° C |
| Vibration: | MIL-STD-202, Method 204, Condition D |
| Shock: | MIL-STD-202, Method 102, Condition C |
| Corrosion: | MIL-STD-202, Method 101, Condition B |

ELECTRICAL

| | |
|------------------------|---|
| Impedance: | 50 Ohms |
| Frequency Range: | DC to 6 GHz |
| Contact Resistance: | Center Contact: 5.0 Milliohms Maximum Outer Contact: 2.5 Milliohms Maximum |
| Insulation Resistance: | 1,000 Megohms Minimum |

MECHANICAL

| | |
|----------------------|--------------------|
| Life: | 500 Cycles |
| Engagement Force: | 3.4 Pounds Maximum |
| Disengagement Force: | 1.4 Pounds Minimum |
| Contact Captivation: | 2.3 Pounds Minimum |

INTERFACE DIMENSIONS



CABLE PLUGS, CRIMP TYPE - FLEXIBLE CABLE

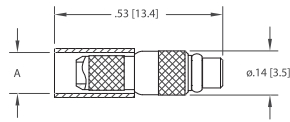

FIGURE 1

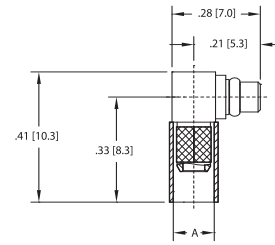

FIGURE 2

CABLE PLUGS, SOLDER TYPE - SEMI-RIGID CABLE

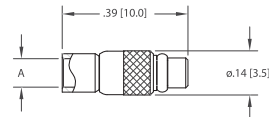

FIGURE 3

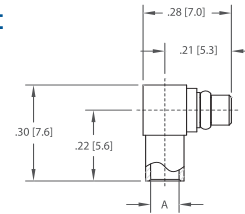

FIGURE 4

CABLE JACK, SOLDER TYPE SEMI-RIGID CABLE



FIGURE 5

CABLE JACK, CRIMP TYPE FLEXIBLE CABLE



FIGURE 6

| Item Number | Military PN | Product Description | Gender | Finish | Dimensions | | | | Cable Group | Cable Procedure | Crimp Die | Mounting Hole | Figure # |
|---------------|-------------|---------------------|--------|--------|------------|---|---|---|-------------|-----------------|-----------|---------------|----------|
| | | | | | A | B | C | D | | | | | |
| 470-900-0631H | | Plug, Crimp | M | Gold | 0.142 | | | | 3 | CAP9-17 | KTH-2015 | | 1 |
| 470-900-0361H | | Plug, Crimp | M | Gold | 0.106 | | | | 52 | CAP9-17 | KTH-2011 | | 1 |
| 470-900-1000H | | Plug, Crimp | M | Gold | 0.128 | | | | 82 | CAP9-17 | KTH-2011 | | 1 |
| 470-900-0360H | | Plug, Crimp | M | Gold | 0.091 | | | | A | CAP9-17 | KTH-2008 | | 1 |
| 470-900-0630H | | Plug, Crimp | M | Gold | 0.128 | | | | B | CAP9-17 | KTH-2011 | | 1 |
| 472-900-0631H | | Plug, Angle, Crimp | M | Gold | 0.142 | | | | 3 | CAP9-18 | KTH-2015 | | 2 |
| 472-900-0361H | | Plug, Angle, Crimp | M | Gold | 0.106 | | | | 52 | CAP9-18 | KTH-2011 | | 2 |
| 472-900-1000H | | Plug, Angle, Crimp | M | Gold | 0.128 | | | | 82 | CAP9-18 | KTH-2011 | | 2 |
| 472-900-0360H | | Plug, Angle, Crimp | M | Gold | 0.091 | | | | A | CAP9-18 | KTH-2008 | | 2 |
| 472-900-0630H | | Plug, Angle, Crimp | M | Gold | 0.128 | | | | B | CAP9-18 | | | 2 |
| 471-900-0631H | | Jack, Crimp | F | Gold | 0.142 | | | | 3 | CAP9-17 | KTH-2015 | | 3 |
| 471-900-0361H | | Jack, Crimp | F | Gold | 0.106 | | | | 52 | CAP9-17 | KTH-2011 | | 3 |
| 471-900-1000H | | Jack, Crimp | F | Gold | 0.128 | | | | 82 | CAP9-17 | KTH-2011 | | 3 |
| 471-900-0360H | | Jack, Crimp | F | Gold | 0.091 | | | | A | CAP9-17 | KTH-2008 | | 3 |
| 471-900-0630H | | Jack, Crimp | F | Gold | 0.128 | | | | B | CAP9-17 | KTH-2011 | | 3 |
| 472-900-0850H | | Plug, Angle, Solder | M | Gold | 0.090 | | | | 50 | CAP5-18 | | | 4 |
| 472-900-0470H | | Plug, Angle, Solder | M | Gold | 0.052 | | | | 51 | CAP5-18 | | | 4 |
| 470-500-0850H | | Plug, Solder | M | Gold | 0.090 | | | | 50 | CAP5-17 | | | 5 |
| 470-500-0470H | | Plug, Solder | M | Gold | 0.052 | | | | 51 | CAP5-17 | | | 5 |
| 471-500-0850H | | Jack, Solder | F | Gold | 0.090 | | | | 50 | CAP5-17 | | | 6 |
| 471-500-0470H | | Jack, Solder | F | Gold | 0.052 | | | | 51 | CAP5-17 | | | 6 |

* For Nickel Plated Version, Change H to N in Part Number

PCB JACKS

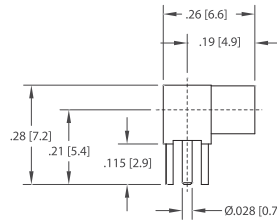

FIGURE 7

FIGURE 8

PCB PLUG

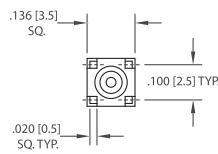

FIGURE 9

END LAUNCH JACK

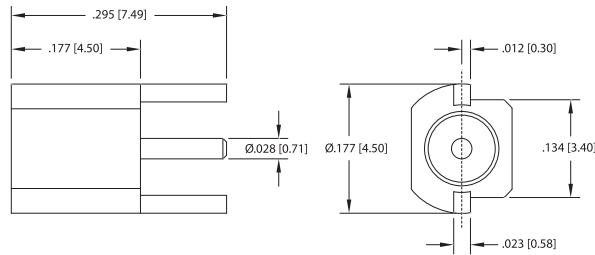

FIGURE 10

| Item Number | Military PN | Product Description | Gender | Finish | Dimensions | | | | Cable Group | Cable Procedure | Crimp Die | Mounting Hole | Figure # |
|---------------|-------------|---------------------|--------|--------|------------|---|---|---|-------------|-----------------|-----------|---------------|----------|
| | | | | | A | B | C | D | | | | | |
| 471-040-0040H | | Jack, PCB | F | Gold | | | | | | | Q | 7 | |
| 473-040-0040H | | Jack, Angle, PCB | F | Gold | | | | | | | Q | 8 | |
| 473-040-0040N | | Jack, Angle, PCB | F | Nickel | | | | | | | Q | 8 | |
| 470-040-0040H | | Plug, PCB | M | Gold | | | | | | | Q | 9 | |
| 471-086-0040H | | Jack, End Launch | F | Gold | | | | | | | | 10 | |
| 471-086-0040N | | Jack, End Launch | F | Nickel | | | | | | | | 10 | |



SPECIFICATIONS

MATERIAL

| | |
|------------------|---|
| Body: | Brass or Stainless Steel |
| Crimp Sleeves: | Commercial Bronze Alloy |
| Center Contacts: | Brass (Male) Beryllium Copper (Female) |
| Outer Contacts: | Phosphor Bronze (Male) |
| Insulators: | PTFE |
| Gaskets & Seals: | Silicone Rubber |

FINISHES

| | |
|------------------|------------------|
| Body: | Silver or Nickel |
| Center Contacts: | Gold |

ELECTRICAL

| | |
|------------------|------------------------|
| Impedance: | 50 Ohms |
| Frequency Range: | DC to 11 GHz |
| Voltage Rating: | 1000 Volts RMS |
| VSWR: | 1.30 Max, DC to 11 GHz |
| Insertion Loss: | .15 dB Max at 9 GHz |

INTERFACE DIMENSIONS

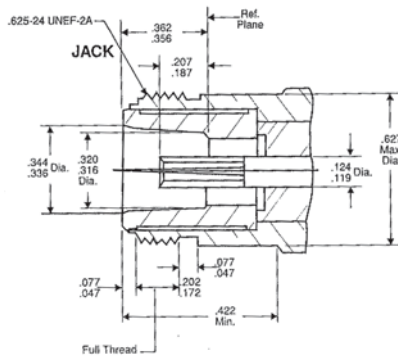

- 50 Ohm Nominal Impedance.
- Threaded coupling withstands shock and vibration.
- Durable brass bodies with Silver or Nickel plating.
- Keyed versions available to prevent mismatching in critical applications.
- Commercial and Military-Specified versions available.
- Frequency Range: Up to 11 GHz

MECHANICAL

| | |
|------------------|-------------------|
| Life: | 500 Cycles |
| Cable Retention: | 75 Pounds Minimum |

ENVIRONMENTAL

| | |
|----------------------|--------------------------------------|
| Temperature Range: | -65° C to +165° C |
| Vibration: | MIL-STD-202, Method 204, Condition B |
| Shock: | MIL-STD-202, Method 213, Condition I |
| Corrosion: | MIL-STD-202, Method 101, Condition B |
| Moisture Resistance: | MIL-STD-202, Method 106 |

PLUG

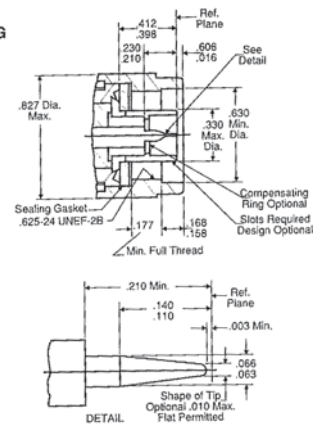

JACK - CONVENTIONAL

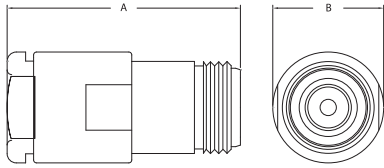

FIGURE 1

BULKHEAD JACK - K-GRIP, JR.

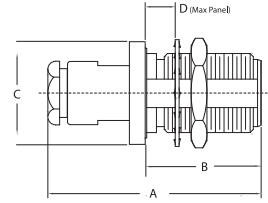

FIGURE 2

JACKS - K-GRIP, JR.

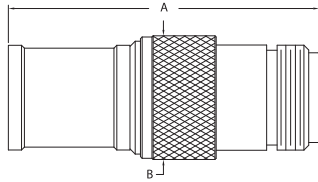

FIGURE 3



FIGURE 4

| Item Number | Military PN | Product Description | Gender | Finish | Dimensions | | | | Cable Group | Cable Procedure | Crimp Die | Mounting Hole | Figure # |
|---------------|----------------|--------------------------------------|--------|--------|------------|-------|-------|-------|-------------|-----------------|-----------|---------------|----------|
| | | | | | A | B | C | D | | | | | |
| KN-39-68 | M39012/02-0003 | Jack, Conventional | F | | 1.580 | 0.750 | | | MN | CP-1016 | | | 1 |
| UG-1186 /U | | Jack, Conventional | F | | 1.580 | 0.750 | | | MN | CP-1016 | | | 1 |
| KN-39-102 | M39012/02-0131 | Jack, Conventional | F | | 2.310 | 0.750 | | | N3 | CP-1608 | | | N/S |
| 1203-18-5 | | Jack, Conventional, Bulkhd, Rear Mt. | F | | 2.470 | 0.930 | 0.750 | 0.286 | 22 | 3-260 | | A | N/S |
| UG-160 C/U | | Jack, Conventional, Bulkhd, Rear Mt. | F | | 1.780 | 0.920 | 0.880 | 0.340 | MN | CP-1024 | | A | 2 |
| 1202-16-5 | | Jack, Conventional, Bulkhd, Rear Mt. | F | | 1.680 | 0.930 | 0.810 | 0.320 | B1 | 3-571 | | A | 2 |
| KN-19-187 M07 | | Jack, Conventional, Bulkhd, Rear Mt. | F | Silver | 1.670 | 0.920 | 0.880 | 0.340 | B1 | CP-1052 | | A | 2 |
| 1202-15-5 | | Jack, Conventional, Bulkhd, Rear Mt. | F | | 1.680 | 0.930 | 0.500 | 0.320 | DE | 3-561 | | A | 2 |
| UG-556 B/U | | Jack, Conventional, Bulkhd, Rear Mt. | F | | 1.680 | 0.920 | 0.810 | 0.320 | DE | CP-1019 | | A | 2 |
| KN-19-42 | | Jack, Conventional, Bulkhd, Rear Mt. | F | | 1.430 | 0.920 | 0.880 | 0.340 | E1 | CP-1021 | | A | 2 |
| KN-19-114 | M39012/03-0012 | Jack, Conventional, Bulkhd, Rear Mt. | F | | 1.770 | 0.920 | 0.880 | 0.340 | MN | CP-1016 | | A | 2 |
| KN-39-93 | | Jack, Crimp, Weatherproof | F | Nickel | 1.730 | 0.630 | | | 2 | CP-5402 | KTH-1079 | | 3 |
| 1203-13-9 | | Jack, Crimp, Weatherproof | F | Nickel | 1.840 | 0.730 | | | 5 | CP-5402 | KTH-2177 | | 3 |
| KN-39-114 M06 | | Jack, Crimp, Weatherproof | F | Nickel | 1.640 | 0.630 | | | 12 | CP-5402 | KTH-2127 | | 3 |
| 1203-14-9 | | Jack, Crimp, Weatherproof | F | Nickel | 1.570 | 0.650 | | | 16 | 3-546-2 | KTH-2211 | | 3 |
| 1203-19-9 | | Jack, Crimp, Weatherproof | F | | 1.600 | 0.650 | | | 17 | 3-546-2 | KTH-2231 | | 3 |
| 1203-20-9 | | Jack, Crimp, Weatherproof | F | | 1.630 | 0.650 | | | 18 | 3-546-2 | KTH-2212 | | 3 |
| 1203-16-9 | | Jack, Crimp, Weatherproof | F | | 1.730 | 0.650 | | | 19 | 3-546-2 | KTH-2213 | | 3 |
| 1203-21-9 | | Jack, Crimp, Weatherproof | F | | 1.840 | 0.740 | | | 20 | 3-546-2 | KTH-2229 | | 3 |
| KN-39-72 | | Jack, Crimp, Weatherproof | F | | 1.580 | 0.630 | | | 45 | CP-5406 | KTH-2103 | | 3 |
| 1203-4-9 | | Jack, Crimp, Weatherproof | F | | 1.730 | 0.630 | | | N3 | CP-5402 | KTH-2105 | | 3 |
| KN-39-75 | | Jack, Crimp, Weatherproof | F | | 1.620 | 0.630 | | | P | CP-444 | KTH-1079 | | 3 |
| KN-39-86 | M39012/02-0503 | Jack, Crimp | F | | 1.580 | 0.630 | | | E1 | CP-489 | KTH-2042 | | 4 |
| KN-39-52 | | Jack, Crimp | F | | 1.410 | 0.630 | | | M1 | CP-433 | KTH-2003 | | 4 |
| KN-39-92 | | Jack, Crimp | F | | 1.610 | 0.630 | | | M1 | CP-480 | KTH-2004 | | 4 |
| KN-39-83 | M39012/02-0501 | Jack, Crimp | F | | 1.610 | 0.630 | | | N1-3 | CP-480 | KTH-2004 | | 4 |
| KN-39-97 | | Jack, Crimp | F | | 1.690 | 0.720 | | | | CP-480 | KTH-2043 | | 4 |
| 1203-23-9 | | Jack, Crimp | F | | 1.610 | 0.680 | | | 86 | CP-480 | KTH-2135 | | 4 |
| 1203-24-9 | | Jack, Crimp | F | | 1.750 | 0.730 | | | 88 | CP-480 | KTH-2259 | | 4 |

PANEL JACK - CONVENTIONAL

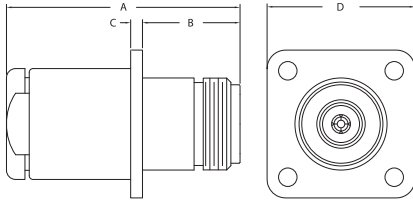

FIGURE 5

ANGLE JACK - K-GRIP, JR.



FIGURE 6

BULKHEAD JACKS - K-GRIP, JR.

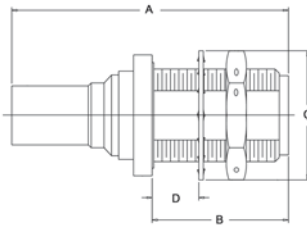

FIGURE 7

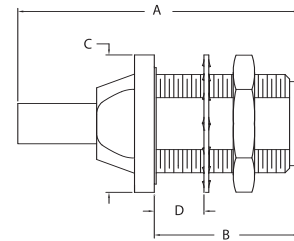

FIGURE 8

| Item Number | Military PN | Product Description | Gender | Finish | Dimensions | | | | Cable Group | Cable Procedure | Crimp Die | Mounting Hole | Figure # |
|---------------|----------------|--------------------------------------|--------|--------|------------|-------|-------|-------|-------------|-----------------|-----------|---------------|----------|
| | | | | | A | B | C | D | | | | | |
| 1201-9-5 | M39012/02-0006 | Jack, Conventional, Panel, Panel Mt. | F | | 1.670 | 0.660 | 0.080 | 1.000 | MN | 3-539 | | | 5 |
| KN-19-110 | M39012/02-0006 | Jack, Conventional, Panel | F | | 1.580 | 0.660 | 0.080 | 1.000 | MN | 3-66 | | | 5 |
| UG-1095 B/U | | Jack, Panel | F | Silver | 1.420 | 0.660 | 0.080 | 1.000 | D | CP-1015 | | | 5 |
| 1203-15-9 | | Jack, Crimp, Weatherproof, Angle | F | | 1.350 | 1.760 | | | 16 | 3-546-2 | KTH-2211 | | 6 |
| 1202-20-9 | | Jack, Crimp, Bulkhd, Weatherproof | F | | 1.850 | 0.920 | 0.880 | 0.324 | 18 | 3-546-2 | KTH-2212 | A | 7 |
| 1202-26-9 | | Jack, Crimp, Bulkhd, Weatherproof | F | | 1.940 | 0.920 | 0.880 | 0.324 | 19 | 3-546-2 | KTH-2213 | A | 7 |
| 1202-23-9 | | Jack, Crimp, Bulkhd, Weatherproof | F | | 2.090 | 0.920 | 0.810 | 0.324 | 20 | 3-546-2 | KTH-2229 | A | 7 |
| KN-19-151 | M39012/03-0503 | Jack, Crimp, Bulkhd | F | | 1.780 | 0.920 | 0.880 | 0.324 | E1 | CP-489 | KTH-2042 | A | 8 |
| KN-19-150 | M39012/03-0502 | Jack, Crimp, Bulkhd | F | | 1.820 | 0.920 | 0.880 | 0.324 | M1 | CP-480 | KTH-2004 | A | 8 |
| KN-19-145 | | Jack, Crimp, Bulkhd | F | | 1.820 | 0.920 | 0.880 | 0.250 | N | CP-480 | KTH-2004 | A | 8 |
| KN-19-149 | M39012/03-0501 | Jack, Crimp, Bulkhd | F | Silver | 1.820 | 0.920 | 0.880 | 0.125 | NP | CP-480 | KTH-2004 | A | 8 |
| KN-19-186 M07 | | Jack, Crimp, Bulkhd | F | Silver | 1.820 | 0.920 | 0.880 | 0.187 | NP | CP-480 | KTH-2004 | A | 8 |
| KN-19-196 M06 | | Jack, Crimp, Bulkhd, Weatherproof | F | Nickel | 1.950 | 0.920 | 0.880 | | N3 | CP-5402 | KTH-2105 | A | N/S |
| 1202-35-9 | | Jack, Crimp, Bulkhd | F | Nickel | 1.770 | 0.625 | 0.880 | | | 3-440-2 | KTH-2002 | N/S | N/S |
| 1202-25-5 | | Jack, Crimp, Bulkhd | F | Silver | 1.900 | 0.920 | 0.900 | 0.324 | | 3-597 | KTH-2005 | A | 8 |
| 1202-21-5 | | Jack, Crimp, Bulkhd | F | Silver | 2.090 | 0.920 | 0.880 | 0.324 | | CP-5402 | KTH-2012 | A | 8 |
| 1202-22-5 | | Jack, Crimp, Bulkhd | F | Silver | 2.090 | 0.920 | 0.880 | 0.360 | | CP-5402 | KTH-2012 | A | 8 |
| 1202-2-5 | M39012/03-0504 | Jack, Crimp, Bulkhd | F | Silver | 1.780 | 0.920 | 0.880 | | D | CP-489 | KTH-2042 | A | 8 |

PANEL JACKS - K-GRIP, JR.



FIGURE 9

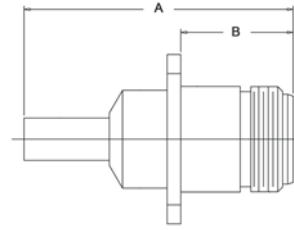

FIGURE 10

| Item Number | Military PN | Product Description | Gender | Finish | Dimensions | | | | Cable Group | Cable Procedure | Crimp Die | Mounting Hole | Figure # |
|---------------|----------------|----------------------------------|--------|--------|------------|-------|-------|---|-------------|-----------------|-----------|---------------|----------|
| | | | | | A | B | C | D | | | | | |
| 2971-3-1 | | Jack, Crimp, Panel, Weatherproof | F | Nickel | 1.710 | 0.950 | 0.800 | | 1 | CP-5406 | KTH-2101 | | 9 |
| 2971-3-11 | | Jack, Crimp, Panel, Weatherproof | F | Nickel | 1.710 | 0.950 | 0.800 | | 1 | CP-5406 | KTH-2101 | | 9 |
| 2971-3-16 | | Jack, Crimp, Panel, Weatherproof | F | Nickel | 1.710 | 0.950 | 0.800 | | 1 | CP-5406 | KTH-2101 | | 9 |
| 2971-3-6 | | Jack, Crimp, Panel, Weatherproof | F | Nickel | 1.710 | 0.950 | 0.800 | | 1 | CP-5406 | KTH-2101 | | 9 |
| KN-19-162 | | Jack, Crimp, Panel, Weatherproof | F | Nickel | 1.730 | 0.660 | 0.720 | | 2 | CP-5402 | KTH-1079 | | 9 |
| 1201-6-9 | | Jack, Crimp, Panel, Weatherproof | F | Nickel | 1.840 | 0.660 | 0.800 | | 5 | CP-5402 | KTH-2177 | | 9 |
| KN-19-198 M06 | | Jack, Crimp, Panel, Weatherproof | F | Nickel | 1.730 | 0.660 | 0.720 | | 12 | CP-5402 | KTH-2127 | | 9 |
| 1201-12-9 | | Jack, Crimp, Panel, Weatherproof | F | Nickel | 1.570 | 0.660 | 0.720 | | 16 | 3-546-2 | KTH-2211 | | 9 |
| 1201-22-9 | | Jack, Crimp, Panel, Weatherproof | F | Nickel | 1.570 | 0.660 | 0.720 | | 16 | 3-546-2 | KTH-2211 | | 9 |
| 2971-8-1 | | Jack, Crimp, Panel, Weatherproof | F | Nickel | 1.700 | 0.945 | 0.720 | | 16 | 3-546-2 | KTH-2211 | | 9 |
| 2971-8-11 | | Jack, Crimp, Panel, Weatherproof | F | Nickel | 1.700 | 0.945 | 0.720 | | 16 | 3-546-2 | KTH-2211 | | 9 |
| 2971-8-16 | | Jack, Crimp, Panel, Weatherproof | F | Nickel | 1.700 | 0.945 | 0.720 | | 16 | 3-546-2 | KTH-2211 | | 9 |
| 2971-8-6 | | Jack, Crimp, Panel, Weatherproof | F | Nickel | 1.700 | 0.945 | 0.720 | | 16 | 3-546-2 | KTH-2211 | | 9 |
| 1201-25-9 | | Jack, Crimp, Panel, Weatherproof | F | Nickel | 1.600 | 0.660 | 0.720 | | 17 | 3-546-2 | KTH-2231 | | 9 |
| 1201-13-9 | | Jack, Crimp, Panel, Weatherproof | F | Nickel | 1.630 | 0.660 | 0.720 | | 18 | 3-546-2 | KTH-2212 | | 9 |
| 1201-23-9 | | Jack, Crimp, Panel, Weatherproof | F | Nickel | 1.630 | 0.660 | 0.720 | | 18 | 3-546-2 | KTH-2212 | | 9 |
| 2971-7-1 | | Jack, Crimp, Panel, Weatherproof | F | Nickel | 1.650 | 0.945 | 0.800 | | 18 | 3-546-2 | KTH-2212 | | 9 |
| 2971-7-11 | | Jack, Crimp, Panel, Weatherproof | F | Nickel | 1.650 | 0.945 | 0.800 | | 18 | 3-546-2 | KTH-2212 | | 9 |
| 2971-7-16 | | Jack, Crimp, Panel, Weatherproof | F | Nickel | 1.650 | 0.945 | 0.800 | | 18 | 3-546-2 | KTH-2212 | | 9 |
| 2971-7-6 | | Jack, Crimp, Panel, Weatherproof | F | Nickel | 1.650 | 0.945 | 0.800 | | 18 | 3-546-2 | KTH-2212 | | 9 |
| 1201-14-9 | | Jack, Crimp, Panel, Weatherproof | F | Nickel | 1.730 | 0.660 | 0.720 | | 19 | 3-546-2 | KTH-2213 | | 9 |
| 1201-24-9 | | Jack, Crimp, Panel, Weatherproof | F | Nickel | 1.730 | 0.660 | 0.720 | | 19 | 3-546-2 | KTH-2213 | | 9 |
| 1201-21-9 | | Jack, Crimp, Panel, Weatherproof | F | Nickel | 1.840 | 0.660 | 0.800 | | 20 | 3-546-2 | KTH-2229 | | 9 |
| KN-19-205 M06 | | Jack, Crimp, Panel, Weatherproof | F | Nickel | 1.600 | 0.660 | 0.720 | | D | CP-5406 | KTH-2101 | | 9 |
| KN-19-115 | | Jack, Crimp, Panel, Weatherproof | F | Nickel | 1.580 | 0.660 | 0.720 | | E1 | CP-5406 | KTH-2101 | | 9 |
| KN-19-118 | | Jack, Crimp, Panel, Weatherproof | F | Nickel | 1.600 | 0.660 | 0.720 | | G1 | CP-5402 | KTH-2062 | | 9 |
| KN-19-208 M06 | | Jack, Crimp, Panel, Weatherproof | F | Nickel | 1.730 | 0.660 | 0.720 | | M1 | CP-5402 | KTH-1078 | | 9 |
| KN-19-195 M06 | | Jack, Crimp, Panel, Weatherproof | F | Nickel | 1.720 | 0.660 | 0.720 | | N3 | CP-5402 | KTH-2105 | | 9 |
| 2971-2-1 | | Jack, Crimp, Panel, Weatherproof | F | Nickel | 1.750 | 0.950 | 0.800 | | N3 | CP-5450 | KTH-2105 | | 9 |
| 2971-2-11 | | Jack, Crimp, Panel, Weatherproof | F | Nickel | 1.750 | 0.950 | 0.800 | | N3 | CP-5450 | KTH-2105 | | 9 |
| 2971-2-16 | | Jack, Crimp, Panel, Weatherproof | F | Nickel | 1.750 | 0.950 | 0.800 | | N3 | CP-5450 | KTH-2105 | | 9 |
| KN-19-199 M06 | | Jack, Crimp, Panel, Weatherproof | F | Nickel | 1.910 | 0.660 | 0.720 | | | CP-5401 | KTH-2128 | | 9 |
| KN-19-148 | M39012/02-0513 | Jack, Crimp, Panel | F | Silver | 1.580 | 0.660 | 0.720 | | E1 | CP-489 | KTH-2042 | | 10 |

PLUGS

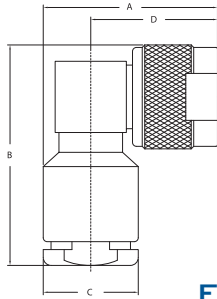

FIGURE 11

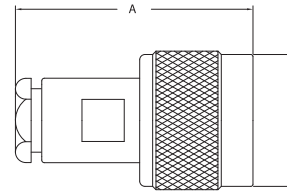

FIGURE 12

PLUG, SOLDER TYPE - SEMI-RIGID CABLE

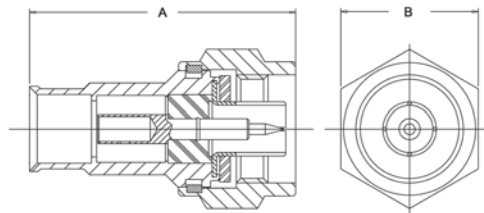

FIGURE 13

| Item Number | Military PN | Product Description | Gender | Finish | Dimensions | | | | Cable Group | Cable Procedure | Crimp Die | Mounting Hole | Figure # |
|---------------|----------------|---------------------------|--------|--------|------------|-------|-------|-------|-------------|-----------------|-----------|---------------|----------|
| | | | | | A | B | C | D | | | | | |
| KN-59-271 | | Plug, Conventional, Angle | M | Nickel | 1.370 | 1.230 | 0.500 | 1.010 | DE | CP-1025 | | | 11 |
| 1206-35-5 | | Plug, Conventional, Angle | M | Silver | 1.380 | 1.720 | 0.750 | 1.010 | MN | CP-1022 | | | 11 |
| KN-59-298 | M39012/05-0101 | Plug, Conventional, Angle | M | Silver | 1.380 | 1.720 | 0.750 | 1.000 | MN | CP-1022 | | | 11 |
| UG-594 B/U | | Plug, Conventional, Angle | M | Silver | 1.380 | 1.720 | 0.750 | 1.010 | MN | CP-1022 | | | 11 |
| KN-59-06 | | Plug, Conventional, Angle | M | Silver | 1.370 | 1.250 | 0.500 | 1.010 | DE | CP-1025 | | | 11 |
| UG-536 B/U | | Plug, Conventional | M | Silver | 1.400 | 0.780 | | | DE | CP-1014 | | | 12 |
| UG-536 C/U | | Plug, Conventional | M | Silver | 1.410 | 0.780 | | | DE | CP-1014 | | | 12 |
| KN-59-57 | | Plug, Crimp | M | Silver | 1.520 | 0.780 | | | L | CP-213A | KTH-2004 | | 12 |
| KN-59-48 | | Plug, Crimp | M | Silver | 1.500 | 0.790 | | | N1 | CP-230A | KTH-2004 | | 12 |
| KN-59-53 | | Plug, Crimp, Angle | M | Silver | 1.380 | 1.660 | 0.750 | 1.010 | N1 | CP-211A | KTH-2004 | | 12 |
| UG-536 A/U | | Plug, Conventional | M | Silver | 1.390 | 0.780 | | | DE | CP-1014 | | | 12 |
| 1205-45-5 | | Plug, Conventional | M | Silver | 1.600 | 0.780 | | | E1 | 3-526 | | | 12 |
| 1205-43-5 | | Plug, Conventional | M | Silver | 1.500 | 0.780 | | | Y | CP-708 | | | 12 |
| KN-59-294 | M39012/01-0101 | Plug, Conventional | M | Silver | 1.500 | 0.790 | | | K2 | CP-1016 | | | 12 |
| 1205-35-5 | | Plug, Conventional | M | Silver | 1.630 | 0.780 | | | MN | 3-539 | | | 12 |
| 1205-64-3 | | Plug, Conventional | M | | 1.500 | 0.780 | | | MN | CP-1016 | | | 12 |
| KN-59-176 | M39012/01-0005 | Plug, Conventional | M | Silver | 1.500 | 0.790 | | | MN | CP-1016 | | | 12 |
| KN-59-173 | | Plug, Conventional | M | Silver | 1.500 | 0.780 | | | MN | CP-1024 | | | 12 |
| KN-59-226 | | Plug, Conventional | M | Silver | 1.520 | 0.780 | | | P | CP-1016 | | | 12 |
| 1205-37-5 | M39012/01-0015 | Plug, Conventional | M | Silver | 1.875 | 0.780 | | | R | 3-539 | | | 12 |
| KN-59-295 | M39012/01-0104 | Plug, Conventional | M | Silver | 2.210 | 0.780 | | | T | CP-1018 | | | 12 |
| KN-59-296 | M39012/01-0125 | Plug, Conventional | M | Silver | 2.110 | 0.780 | | | U | CP-1608 | | | 12 |
| 1205-78-101 | | Plug, Direct Solder | M | | 1.570 | 0.812 | | | | 3-692 | | | 13 |
| 1205-79-101 | | Plug, Direct Solder | M | | 1.570 | 0.812 | | | | 3-692 | | | 13 |
| KN-59-344 MAF | | Plug, Conventional | M | | 1.820 | 0.780 | | | 22 | 3-171 | | | N/S |
| 1200-2-5 | | Plug, Angle, Antenna | M | | 1.370 | 2.790 | 0.860 | 1.150 | | | | | N/S |

ANGLE PLUGS - K-GRIP, JR.



FIGURE 14



FIGURE 15

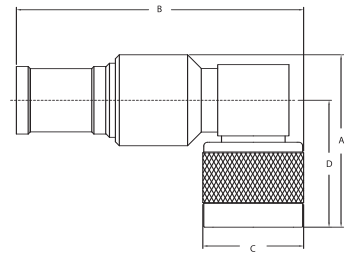

FIGURE 16

PLUGS - K-GRIP, JR.



FIGURE 17



FIGURE 18

| Item Number | Military PN | Product Description | Gender | Finish | Dimensions | | | | Cable Group | Cable Procedure | Crimp Die | Mounting Hole | Figure # |
|---------------|----------------|----------------------------------|--------|--------|------------|-------|-------|-------|-------------|-----------------|-----------|---------------|----------|
| | | | | | A | B | C | D | | | | | |
| 1206-37-9 | | Plug, Crimp, Angle | M | Nickel | 1.350 | 2.050 | 0.812 | 1.010 | 19 | 3-546-2 | KTH-2266 | | 14 |
| KN-59-245 | M39012/05-0503 | Plug, Crimp, Angle | M | Silver | 1.340 | 2.100 | 0.790 | 1.010 | E1 | CP-489 | KTH-2042 | | 14 |
| 1206-5-5 | M39012/05-0504 | Plug, Crimp, Angle | M | Silver | 1.340 | 2.100 | 0.790 | 1.010 | D | CP-489 | KTH-2042 | | 14 |
| KN-59-92 | | Plug, Crimp, Angle | M | Silver | 1.700 | 1.300 | 0.790 | 1.010 | G1 | CP-414 | KTH-2002 | | 14 |
| KN-59-244 | M39012/05-0502 | Plug, Crimp, Angle | M | Silver | 1.340 | 2.140 | 0.790 | 1.010 | M1 | CP-480 | KTH-2004 | | 15 |
| KN-59-243 | M39012/05-0501 | Plug, Crimp, Angle | M | Silver | 1.340 | 2.140 | 0.790 | 1.010 | N1 | CP-480 | KTH-2004 | | 15 |
| KN-59-264 | | Plug, Crimp, Angle, Weatherproof | M | Nickel | 1.340 | 2.260 | 0.790 | 1.010 | N3 | CP-5402 | KTH-2105 | | 15 |
| 1206-31-5 | | Plug, Crimp, Angle | M | Silver | 1.500 | 2.370 | 0.827 | 1.010 | | 3-597 | KTH-2005 | | 15 |
| KN-59-263 | | Plug, Crimp, Angle, Weatherproof | M | Nickel | 1.300 | 2.260 | 0.780 | 1.010 | 2 | CP-5402 | KTH-1079 | | 16 |
| KN-59-263 M07 | | Plug, Crimp, Angle, Weatherproof | M | Silver | 1.300 | 2.260 | 0.780 | 1.010 | 2 | CP-5402 | KTH-1079 | | 16 |
| 1206-11-9 | | Plug, Crimp, Angle, Weatherproof | M | Nickel | 1.370 | 2.380 | 0.780 | 1.010 | 5 | CP-5402 | KTH-2177 | | 16 |
| 1206-16-9 | | Plug, Crimp, Angle, Weatherproof | M | Nickel | 1.370 | 2.380 | 0.790 | 1.010 | 7 | 3-440-2 | KTH-2180 | | 16 |
| KN-59-332 M06 | | Plug, Crimp, Angle, Weatherproof | M | Nickel | 1.300 | 2.170 | 0.780 | 1.010 | 12 | CP-5402 | KTH-2127 | | 16 |
| 1206-21-9 | | Plug, Crimp, Angle, Weatherproof | M | Nickel | 1.340 | 2.100 | 0.827 | 1.010 | 16 | 3-546-2 | KTH-2211 | | 16 |
| 1206-29-9 | | Plug, Crimp, Angle, Weatherproof | M | Nickel | 1.340 | 2.060 | 0.827 | 1.010 | 17 | 3-546-2 | KTH-2231 | | 16 |
| 1206-22-9 | | Plug, Crimp, Angle, Weatherproof | M | Nickel | 1.340 | 2.180 | 0.827 | 1.010 | 18 | 3-546-2 | KTH-2212 | | 16 |
| 1206-26-9 | | Plug, Crimp, Angle, Weatherproof | M | Nickel | 1.340 | 2.280 | 0.827 | 1.010 | 19 | 3-546-2 | KTH-2213 | | 16 |
| KN-59-158 | | Plug, Crimp, Angle, Weatherproof | M | Nickel | 1.300 | 1.750 | 0.790 | 1.005 | D | CP-403 | KTH-2061 | | 16 |
| 1206-30-9 | | Plug, Crimp, Angle, Weatherproof | M | Nickel | 1.370 | 2.380 | 0.827 | 1.010 | 20 | 3-546-2 | KTH-2229 | | 16 |
| KN-59-313 M06 | | Plug, Crimp, Angle, Weatherproof | M | Nickel | 1.340 | 2.100 | 0.827 | 1.010 | E1 | CP-489 | KTH-2101 | | 16 |
| 2975-5-11 | | Plug, Crimp, Weatherproof, Keyed | M | Nickel | 2.050 | 0.970 | | | 19 | 3-546-2 | KTH-2213 | | 17 |
| 2975-5-16 | | Plug, Crimp, Weatherproof, Keyed | M | Nickel | 2.050 | 0.970 | | | 19 | 3-546-2 | KTH-2213 | | 17 |
| 2975-5-6 | | Plug, Crimp, Weatherproof, Keyed | M | Nickel | 2.050 | 0.970 | | | 19 | 3-546-2 | KTH-2213 | | 17 |
| 1205-61-9 | | Plug, Crimp, Weatherproof | M | Nickel | 1.750 | 0.827 | | | 20 | 3-546-2 | KTH-2229 | | 17 |
| KN-59-148 | | Plug, Crimp, Weatherproof | M | Nickel | 1.480 | 0.780 | | | D | CP-415 | KTH-2061 | | 17 |
| KN-59-183 | | Plug, Crimp, Weatherproof | M | Nickel | 1.500 | 0.780 | | | E1 | CP-489 | KTH-2101 | | 17 |
| KN-59-261 | | Plug, Crimp, Weatherproof | M | Nickel | 1.650 | 0.780 | | | M1 | CP-5402 | KTH-1078 | | 17 |

| Item Number | Military PN | Product Description | Gender | Finish | Dimensions | | | | Cable Group | Cable Procedure | Crimp Die | Mounting Hole | Figure # |
|---------------|----------------|----------------------------------|--------|--------|------------|-------|---|---|-------------|-----------------|-----------|---------------|----------|
| | | | | | A | B | C | D | | | | | |
| KN-59-329 M06 | | Plug, Crimp, Weatherproof | M | Nickel | 1.710 | 0.780 | | | N3 | CP-5402 | KTH-2105 | | 17 |
| KN-59-247 | | Plug, Crimp, Weatherproof | M | Nickel | 1.530 | 0.780 | | | D | CP-5406 | KTH-2101 | | 17 |
| KN-59-185 | | Plug, Crimp, Weatherproof | M | Nickel | 1.500 | 0.780 | | | 45 | CP-5406 | KTH-2103 | | 17 |
| 2975-2-1 | | Plug, Crimp, Weatherproof, Keyed | M | Nickel | 1.900 | 0.960 | | | 1 | CP-489 | KTH-2101 | | 17 |
| 2975-2-11 | | Plug, Crimp, Weatherproof, Keyed | M | Nickel | 1.900 | 0.960 | | | 1 | CP-489 | KTH-2101 | | 17 |
| 2975-2-16 | | Plug, Crimp, Weatherproof, Keyed | M | Nickel | 1.900 | 0.960 | | | 1 | CP-489 | KTH-2101 | | 17 |
| 2975-2-6 | | Plug, Crimp, Weatherproof, Keyed | M | Nickel | 1.900 | 0.960 | | | 1 | CP-489 | KTH-2101 | | 17 |
| KN-59-220 | | Plug, Crimp, Weatherproof | M | Nickel | 1.650 | 0.780 | | | 2 | CP-5402 | KTH-1079 | | 17 |
| KN-59-220 M07 | | Plug, Crimp, Weatherproof | M | Silver | 1.650 | 0.780 | | | 2 | CP-5402 | KTH-1079 | | 17 |
| 1205-31-9 | | Plug, Crimp, Weatherproof | M | Nickel | 1.750 | 0.780 | | | 5 | CP-5402 | KTH-2177 | | 17 |
| 1205-30-9 | | Plug, Crimp, Weatherproof | M | Nickel | 1.650 | 0.780 | | | 7 | 3-440-2 | KTH-2180 | | 17 |
| KN-59-330 M06 | | Plug, Crimp, Weatherproof | M | Nickel | 1.550 | 0.780 | | | 12 | CP-5402 | KTH-2127 | | 17 |
| 1205-47-9 | | Plug, Crimp, Weatherproof | M | Nickel | 1.500 | 0.827 | | | 16 | 3-546-2 | KTH-2211 | | 17 |
| 2975-4-1 | | Plug, Crimp, Weatherproof, Keyed | M | Nickel | 1.900 | 0.970 | | | 16 | 3-546-2 | KTH-2211 | | 17 |
| 2975-4-11 | | Plug, Crimp, Weatherproof, Keyed | M | Nickel | 1.900 | 0.970 | | | 16 | 3-546-2 | KTH-2211 | | 17 |
| 2975-4-16 | | Plug, Crimp, Weatherproof, Keyed | M | Nickel | 1.900 | 0.970 | | | 16 | 3-546-2 | KTH-2211 | | 17 |
| 2975-4-6 | | Plug, Crimp, Weatherproof, Keyed | M | Nickel | 1.900 | 0.970 | | | 16 | 3-546-2 | KTH-2211 | | 17 |
| 1205-62-7 | | Plug, Crimp, Weatherproof | M | Nickel | 1.530 | 0.827 | | | 17 | 3-546-2 | KTH-2231 | | 17 |
| 1205-62-9 | | Plug, Crimp, Weatherproof | M | Nickel | 1.530 | 0.827 | | | 17 | 3-546-2 | KTH-2231 | | 17 |
| 1205-48-9 | | Plug, Crimp, Weatherproof | M | Nickel | 1.550 | 0.827 | | | 18 | 3-546-2 | KTH-2212 | | 17 |
| 2975-6-1 | | Plug, Crimp, Weatherproof, Keyed | M | Nickel | 1.960 | 0.970 | | | 18 | 3-546-2 | KTH-2212 | | 17 |
| 2975-6-11 | | Plug, Crimp, Weatherproof, Keyed | M | Nickel | 1.960 | 0.970 | | | 18 | 3-546-2 | KTH-2212 | | 17 |
| 2975-6-16 | | Plug, Crimp, Weatherproof, Keyed | M | Nickel | 1.960 | 0.970 | | | 18 | 3-546-2 | KTH-2212 | | 17 |
| 2975-6-6 | | Plug, Crimp, Weatherproof, Keyed | M | Nickel | 1.960 | 0.970 | | | 18 | 3-546-2 | KTH-2212 | | 17 |
| 1205-49-9 | | Plug, Crimp, Weatherproof | M | Nickel | 1.650 | 0.827 | | | 19 | 3-546-2 | KTH-2213 | | 17 |
| 2975-5-1 | | Plug, Crimp, Weatherproof, Keyed | M | Nickel | 2.050 | 0.970 | | | 19 | 3-546-2 | KTH-2213 | | 17 |
| KN-59-160 | | Plug, Crimp, Weatherproof | M | Nickel | 1.450 | 0.780 | | | | CP-460 | KTH-2101 | | 17 |
| KN-59-361 M06 | | Plug, Crimp, Weatherproof | M | Nickel | 1.520 | 0.780 | | | G1 | CP-5402 | KTH-2062 | | 17 |
| KN-59-266 | | Plug, Crimp | M | Silver | 1.610 | 0.780 | | | | CP-480 | KTH-2043 | | N/S |
| KN-59-118 | | Plug, Crimp | M | Nickel | 1.450 | 0.780 | | | D | CP-415 | KTH-2001 | | 18 |
| 1205-19-5 | M39012/01-0504 | Plug, Crimp | M | Silver | 1.500 | 0.780 | | | D | CP-489 | KTH-2042 | | 18 |
| KN-59-122 | | Plug, Crimp | M | Nickel | 1.440 | 0.780 | | | E1 | CP-415 | KTH-2001 | | 18 |
| KN-59-242 | M39012/01-0503 | Plug, Crimp | M | Silver | 1.500 | 0.780 | | | E1 | CP-489 | KTH-2042 | | 18 |
| KN-59-242 M06 | | Plug, Crimp | M | Nickel | 1.500 | 0.780 | | | E1 | CP-489 | KTH-2042 | | 18 |
| KN-59-260 | | Plug, Crimp | M | Silver | 1.530 | 0.780 | | | | CP-480 | KTH-2004 | | 18 |
| KN-59-132 | | Plug, Crimp | M | Nickel | 1.320 | 0.780 | | | M1 | CP-402 | KTH-2003 | | 18 |
| 1205-68-5 | M39012/01-0017 | Plug, Crimp | M | Silver | 2.000 | 0.827 | | | M1 | 3-610 | KTH-2004 | | 18 |
| KN-59-201 | | Plug, Crimp | M | Nickel | 1.530 | 0.780 | | | M1 | CP-480 | KTH-2004 | | 18 |
| KN-59-202 | M39012/01-0502 | Plug, Crimp | M | Silver | 1.530 | 0.780 | | | M1 | CP-480 | KTH-2004 | | 18 |
| KN-59-104 | | Plug, Crimp | M | Nickel | 1.320 | 0.780 | | | N1 | CP-402 | KTH-2004 | | 18 |
| KN-59-68 | | Plug, Crimp | M | Silver | 1.320 | 0.780 | | | N1 | CP-402 | KTH-2004 | | 18 |
| 1205-69-5 | M39012/01-0018 | Plug, Crimp | M | Silver | 1.530 | 0.780 | | | N1 | CP-480 | KTH-2004 | | 18 |
| KN-59-239 | M39012/01-0501 | Plug, Crimp | M | Silver | 1.530 | 0.780 | | | N1 | CP-480 | KTH-2004 | | 18 |
| 1205-67-9 | | Plug, Crimp | M | Nickel | 1.500 | 0.780 | | | | CP-5455 | KTH-2118 | | 18 |
| 1205-4-9 | | Plug, Crimp | M | Nickel | 1.610 | 0.780 | | | | CP-480 | KTH-2135 | | 18 |
| 1205-77-9 | | Plug, Crimp | M | Nickel | 1.630 | 0.820 | | | 88 | CP-480 | KTH-2259 | | 18 |
| 1205-65-5 | | Plug, Crimp | M | Silver | 1.500 | 0.780 | | | | 3-597 | KTH-2005 | | 18 |
| 1205-59-5 | | Plug, Crimp | M | Silver | 1.828 | 0.827 | | | | CP-5402 | KTH-2012 | | 18 |

RECEPTACLES



FIGURE 19

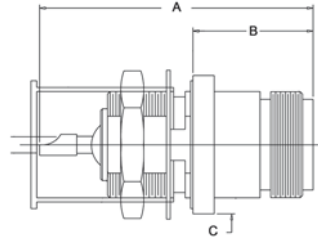

FIGURE 20

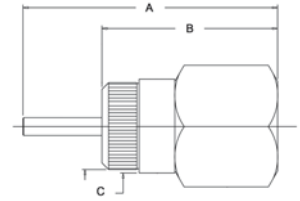

FIGURE 21

PANEL RECEPTACLES



FIGURE 22



FIGURE 23

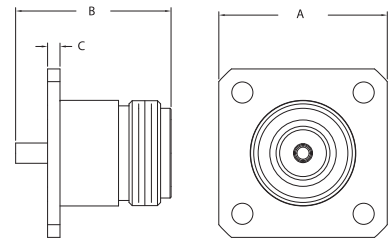

FIGURE 24

TERMINATION

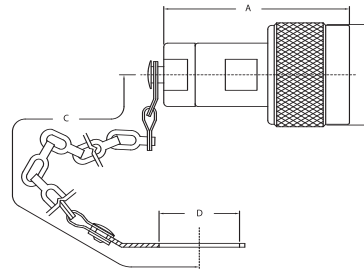

FIGURE 25

| Item Number | Military PN | Product Description | Gender | Finish | Dimensions | | | | Cable Group | Cable Procedure | Crimp Die | Mounting Hole | Figure # |
|--------------|----------------|--------------------------|--------|--------|------------|-------|-------|-------|-------------|-----------------|-----------|---------------|----------|
| | | | | | A | B | C | D | | | | | |
| 1204-12-5 | | Receptacle | F | Silver | 1.480 | 0.850 | 0.630 | | | | | 19 | |
| 1204-20-9 | | Receptacle | F | Nickel | 1.340 | 0.780 | 0.630 | | | | | 19 | |
| KN-79-69 | M39012/04-0001 | Receptacle | F | Silver | 1.610 | 0.710 | 0.810 | | | | | 20 | |
| 1204-17-5 | | Receptacle | M | | 1.710 | 1.180 | 0.810 | | | | | 21 | |
| KN-79-45 M06 | | Receptacle, Panel | M | Nickel | 1.000 | 1.110 | 0.080 | 0.780 | | | | 22 | |
| 1207-27-5 | | Receptacle, Panel, Angle | F | Silver | 1.880 | 1.050 | 0.080 | 1.570 | | | | 23 | |
| UG-997 A/U | | Receptacle, Panel, Angle | F | Silver | 1.520 | 0.910 | 0.080 | 1.410 | | | | 23 | |
| 1207-14-9 | | Receptacle, Panel | F | Nickel | 1.000 | 0.916 | 0.080 | | | | | 24 | |
| 1207-29-9 | | Receptacle, Panel | F | Nickel | 0.690 | 1.177 | 0.080 | | | | | 24 | |
| KN-79-70 | M39012/04-0002 | Receptacle, Panel | F | Silver | 1.000 | 1.130 | 0.080 | 0.630 | | | | 24 | |
| 1208-10-5 | | Termination | M | Silver | 1.590 | 0.780 | 3.750 | 0.640 | | | | 25 | |
| 1208-28-5 | | Termination | M | Silver | 1.590 | 0.780 | 8.000 | 0.640 | | | | 25 | |
| 1385-13-9 | | Termination | M | Nickel | 1.530 | 0.780 | 3.750 | 0.640 | | | | 25 | |
| 1385-17-9 | | Termination | M | Nickel | 1.530 | 0.780 | N/A | N/A | | | | 25 | |

ADAPTERS - WITHIN SERIES

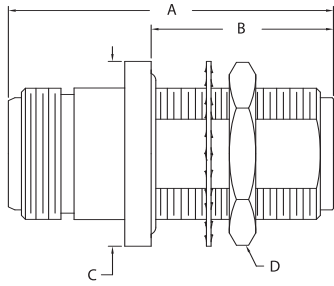

FIGURE 26

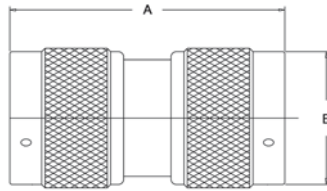

FIGURE 27

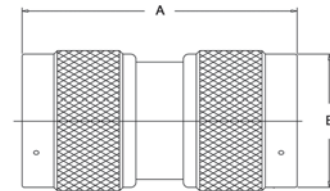

FIGURE 28

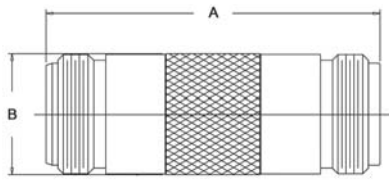

FIGURE 29

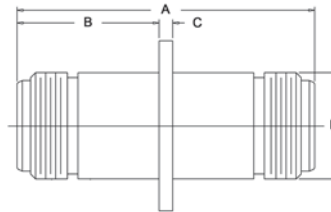

FIGURE 30

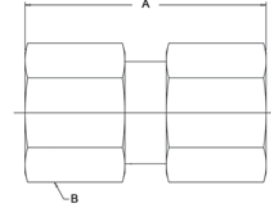

FIGURE 31

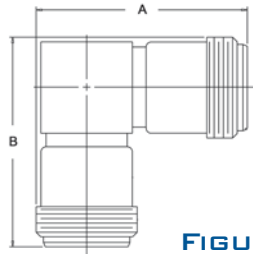

FIGURE 32



FIGURE 33

| Item Number | Military PN | Product Description | Gender | Finish | Dimensions | | | | Cable Group | Cable Procedure | Crimp Die | Mounting Hole | Figure # |
|---------------|-----------------|-----------------------|--------|--------|------------|-------|-------|-------|-------------|-----------------|-----------|---------------|----------|
| | | | | | A | B | C | D | | | | | |
| 1209-12 | M55339/04-00030 | Within Series Adapter | F-F | Silver | 1.540 | 0.860 | 0.880 | 0.750 | | | | A0 | 26 |
| UG-30 E/U | | Within Series Adapter | F-F | Silver | 1.540 | 0.860 | 0.880 | 0.930 | | | | A0 | 26 |
| KN-99-34 | | Within Series Adapter | F-F | Silver | 1.750 | 0.860 | 0.880 | 0.750 | | | | A0 | 26 |
| KN-99-34 M06 | | Within Series Adapter | F-F | Nickel | 1.750 | 0.860 | 0.880 | 0.750 | | | | A0 | 26 |
| KN-99-58 | | Within Series Adapter | F-F | Nickel | 1.540 | 0.860 | 0.880 | 0.750 | | | | A0 | 26 |
| 1209-19 | M55339/04-00001 | Within Series Adapter | F-F | Silver | 1.540 | 0.860 | 0.880 | 0.750 | | | | A0 | 26 |
| 1209-9 | M55339/05-00057 | Within Series Adapter | M-M | Silver | 1.620 | 0.790 | | | | | | | 27 |
| KN-99-44 | | Within Series Adapter | M-M | Nickel | 1.600 | 0.780 | | | | | | | 27 |
| UG-57 B/U | | Within Series Adapter | M-M | Silver | 1.600 | 0.780 | | | | | | | 28 |
| KN-99-50 | | Within Series Adapter | F-F | Nickel | 1.750 | 0.630 | | | | | | | 29 |
| 1209-13 | M55339/07-00029 | Within Series Adapter | F-F | Silver | 1.750 | 0.630 | | | | | | | 29 |
| 1209-44-5 | | Within Series Adapter | F-F | Silver | 1.750 | 0.810 | 0.080 | 0.630 | | | | | 30 |
| KN-99-102 M06 | | Within Series Adapter | F-F | Nickel | 1.750 | 0.810 | 0.080 | 0.630 | | | | | 30 |
| KN-99-14 | | Within Series Adapter | F-F | Silver | 1.750 | 0.810 | 0.080 | 0.630 | | | | | 30 |
| 1209-74-22 | | Within Series Adapter | M-M | | 1.620 | 0.810 | | | | | | | 31 |
| KN-99-30 | | Within Series Adapter | F-F | Silver | 1.300 | 1.300 | | | | | | | 32 |
| 1209-10 | M55339/03-00027 | Within Series Adapter | M-F | Silver | 1.370 | 1.320 | 0.780 | | | | | | 33 |
| UG-27 C/U | | Within Series Adapter | M-F | Silver | 1.370 | 1.320 | 0.780 | | | | | | 33 |
| UG-27 D/U | | Within Series Adapter | M-F | Silver | 1.370 | 1.320 | 0.780 | | | | | | 33 |

ACCESSORIES

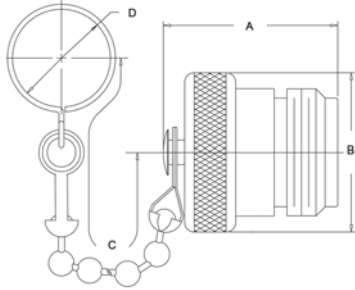

FIGURE 34

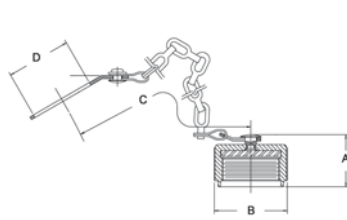

FIGURE 35

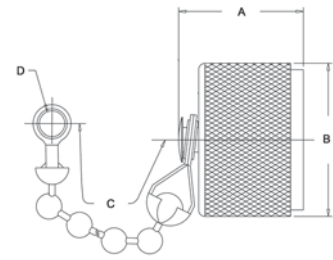

FIGURE 36



FIGURE 37



FIGURE 38

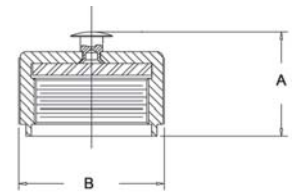

FIGURE 39

| Item Number | Military PN | Product Description | Gender | Finish | Dimensions | | | | Cable Group | Cable Procedure | Crimp Die | Mounting Hole | Figure # |
|--------------|----------------|---------------------|--------|--------|------------|-------|-------|-------|-------------|-----------------|-----------|---------------|----------|
| | | | | | A | B | C | D | | | | | |
| KN-89-12 | | Dust Cap & Chain | F | | 0.840 | 0.780 | 4.500 | 0.480 | | | | | 34 |
| KN-89-13 | | Dust Cap | F | | 0.812 | 0.781 | | | | | | | N/S |
| 1208-45-5 | | Dust Cap & Chain | M | | 0.550 | 0.750 | 3.750 | 0.675 | | | | | 35 |
| KN-89-31 | M39012/25-0012 | Dust Cap & Chain | M | | 0.550 | 0.750 | 3.750 | 0.640 | | | | | 35 |
| KN-89-14 | | Dust Cap & Chain | M | | 0.550 | 0.750 | 5.000 | 0.140 | | | | | 36 |
| KN-89-30 | M39012/25-0011 | Dust Cap & Chain | M | | 0.550 | 0.750 | 2.500 | 0.140 | | | | | 36 |
| KN-89-87 M07 | | Dust Cap & Chain | M | Silver | 0.430 | 0.750 | 5.000 | 0.480 | | | | | 37 |
| KN-89-05 | | Dust Cap & Chain | F | | 0.950 | 0.750 | 4.380 | 0.140 | | | | | 38 |
| 1208-46-5 | | Dust Cap | M | | 0.550 | 0.750 | | | | | | | 39 |



- 50 Ohm Nominal Impedance.
- Push/Pull connection system allows for quicker mating.
- When mated, the connectors can rotate 360 degrees.
- Mates with standard N Series jacks with a thread length of .1879 +/- .0159.
- Frequency Range: Up to 11 GHz

SPECIFICATIONS

MATERIAL

| | |
|------------------|---------------------------------------|
| Body: | Brass |
| Crimp Sleeves: | Copper Alloy |
| Center Contacts: | Brass (Male) Copper Alloy (Female) |
| Outer Contacts: | Copper Alloy |
| Insulators: | PTFE |

FINISHES

| | |
|------------------|----------|
| Body: | TriMetal |
| Center Contacts: | Gold |

ELECTRICAL

| | |
|------------------------|---|
| Impedance: | 50 Ohms |
| Frequency Range: | DC to 11 GHz |
| Voltage Rating: | 1000 Volts RMS |
| VSWR: | 1.20 Maximum |
| Return Loss: | -20.8 dB Minimum |
| Insulation Resistance: | 5,000 Megohms Minimum |
| Contact Resistance: | Center Contact: 3.0 Milliohms Maximum Outer Contact: 3.0 Milliohms Maximum |

MECHANICAL

| | |
|----------------------|-------------------|
| Life: | 500 Cycles |
| Mating Force: | 20 Pounds Maximum |
| Unmating Force: | 20 Pounds Maximum |
| Connector Retention: | 50 Pounds Minimum |

ENVIRONMENTAL

| | |
|----------------------|--------------------------------------|
| Temperature Range: | -65° C to +165° C |
| Vibration: | MIL-STD-202, Method 204, Condition B |
| Shock: | MIL-STD-202, Method 213, Condition I |
| Thermal Shock: | MIL-STD-202, Method 107, Condition B |
| Corrosion: | MIL-STD-202, Method 101, Condition B |
| Moisture Resistance: | MIL-STD-202, Method 106 |

CABLE PLUG, CRIMP TYPE - FLEXIBLE CABLE



FIGURE 1

ADAPTERS

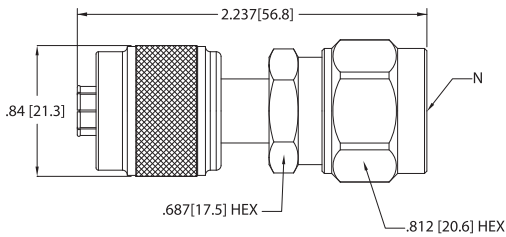

FIGURE 2

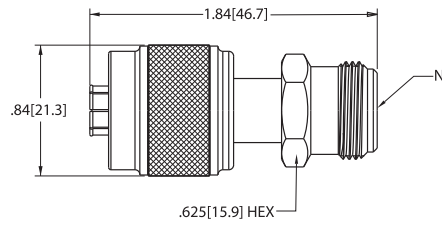

FIGURE 3

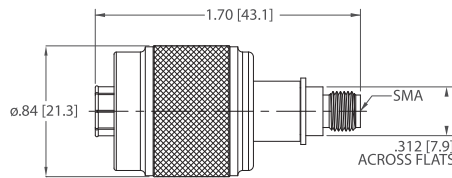

FIGURE 4

| Item Number | Military PN | Product Description | Gender | Finish | Dimensions | | | | Cable Group | Cable Procedure | Crimp Die | Mounting Hole | Figure # |
|---------------|-------------|------------------------------|--------|----------|------------|-------|---|---|-------------|-----------------|-----------|---------------|----------|
| | | | | | A | B | C | D | | | | | |
| 120-900-2000R | | Plug, Crimp | M | Trimetal | 1.947 | 0.206 | | | 84 | | KTH-2001 | | 1 |
| 120-900-2400R | | Plug, Crimp | M | Trimetal | 1.947 | 0.262 | | | 89 | | KTH-2002 | | 1 |
| 120-900-1160R | | Plug, Crimp | M | Trimetal | 1.720 | 0.206 | | | D | | KTH-2001 | | 1 |
| 120-900-1161R | | Plug, Crimp | M | Trimetal | 1.720 | 0.219 | | | E | | KTH-2001 | | 1 |
| 120-600-0000R | | Adapter, QC-N (M) to N (M) | M-M | Trimetal | | | | | | | | | 2 |
| 120-601-0000R | | Adapter, QC-N (M) to N (F) | M-F | Trimetal | | | | | | | | | 3 |
| 120-351-000R | | Adapter, QC-N (M) to SMA (F) | M-F | Trimetal | | | | | | | | | 4 |

SC SERIES



- 50 Ohm Nominal Impedance.
- Threaded version of the C Series connector.
- Durable and weatherproof – ideal for harsh environments.
- Keyed versions available to prevent mismatching and misalignment in critical applications.
- Frequency Range: Up to 11 GHz

SPECIFICATIONS

MATERIAL

| | |
|------------------|---|
| Body: | Brass |
| Crimp Sleeves: | Commercial Bronze Alloy |
| Center Contacts: | Brass (Male) Beryllium Copper (Female) |
| Outer Contacts: | Beryllium Copper (Male) |
| Insulators: | PTFE |
| Gaskets & Seals: | Silicone Rubber |

FINISHES

| | |
|------------------|------------------|
| Body: | Silver or Nickel |
| Center Contacts: | Gold or Silver |

MECHANICAL

| | |
|------------------|-------------------|
| Life: | 500 Cycles |
| Cable Retention: | 50 Pounds Minimum |

ELECTRICAL

| | |
|------------------|------------------------|
| Impedance: | 50 Ohms |
| Frequency Range: | DC to 11 GHz |
| Voltage Rating: | 1000 Volts RMS |
| VSWR: | 1.30 Max, DC to 11 GHz |
| Insertion Loss: | .15 dB Max at 9 GHz |

ENVIRONMENTAL

| | |
|----------------------|--------------------------------------|
| Temperature Range: | -65° C to +165° C |
| Vibration: | MIL-STD-202, Method 204, Condition B |
| Shock: | MIL-STD-202, Method 213, Condition I |
| Corrosion: | MIL-STD-202, Method 101, Condition B |
| Moisture Resistance: | MIL-STD-202, Method 106 |

INTERFACE DIMENSIONS

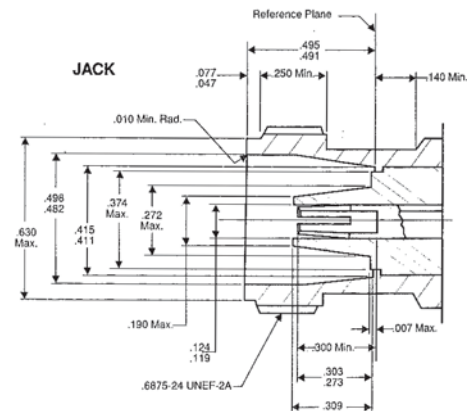
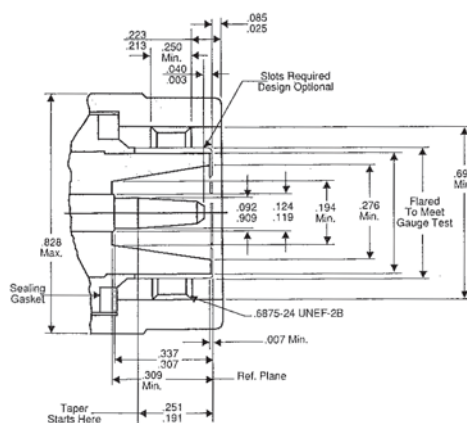

PLUG - K-GRIP, JR.



FIGURE 1

JACK - K-GRIP, JR.



FIGURE 2

ANGLE PLUG - K-GRIP, JR.

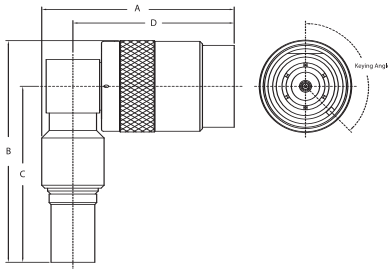

FIGURE 3

PANEL JACK - K-GRIP, JR.



FIGURE 4

| Item Number | Military PN | Product Description | Gender | Finish | Dimensions | | | | Cable Group | Cable Procedure | Crimp Die | Mounting Hole | Figure # |
|--------------|-------------|-------------------------|--------|--------|------------|-------|-------|-------|-------------|-----------------|-----------|---------------|----------|
| | | | | | A | B | C | D | | | | | |
| 825-10-9 | | Plug, Crimp | M | Nickel | 1.620 | 0.828 | | | 16 | 3-546-2 | KTH-2211 | | 1 |
| 825-11-9 | | Plug, Crimp | M | Nickel | 1.695 | 0.828 | | | 18 | 3-546-2 | KTH-2212 | | 1 |
| 825-12-9 | | Plug, Crimp | M | Nickel | 1.790 | 0.828 | | | 19 | 3-546-2 | KTH-2213 | | 1 |
| 825-14-9 | | Plug, Crimp | M | Nickel | 1.790 | 0.828 | | | 20 | 3-546-2 | KTH-2229 | | 1 |
| KG-59-34 M06 | | Plug, Crimp | M | Nickel | 1.720 | 0.780 | | | N3 | CP-5402 | KTH-2105 | | 1 |
| 2985-2-1 | | Plug, Crimp, Keyed 42° | M | Nickel | 2.180 | 0.960 | | | 1 | CP-489 | KTH-2101 | | 1 |
| 2985-2-11 | | Plug, Crimp, Keyed 162° | M | Nickel | 2.180 | 0.960 | | | 1 | CP-489 | KTH-2101 | | 1 |
| 2985-2-16 | | Plug, Crimp, Keyed 222° | M | Nickel | 2.180 | 0.960 | | | 1 | CP-489 | KTH-2101 | | 1 |
| 2985-2-6 | | Plug, Crimp, Keyed 102° | M | Nickel | 2.180 | 0.960 | | | 1 | CP-489 | KTH-2101 | | 1 |
| 2985-3-1 | | Plug, Crimp, Keyed 42° | M | Nickel | 2.180 | 0.980 | | | 16 | 3-546-2 | KTH-2211 | | 1 |
| 2985-3-11 | | Plug, Crimp, Keyed 162° | M | Nickel | 2.180 | 0.980 | | | 16 | 3-546-2 | KTH-2211 | | 1 |
| 2985-3-16 | | Plug, Crimp, Keyed 222° | M | Nickel | 2.180 | 0.980 | | | 16 | 3-546-2 | KTH-2211 | | 1 |
| 2985-3-6 | | Plug, Crimp, Keyed 102° | M | Nickel | 2.180 | 0.980 | | | 16 | 3-546-2 | KTH-2211 | | 1 |
| 2985-6-1 | | Plug, Crimp, Keyed 42° | M | Nickel | 2.480 | 0.970 | | | 20 | 3-546-2 | KTH-2229 | | 1 |
| 2985-6-11 | | Plug, Crimp, Keyed 162° | M | Nickel | 2.480 | 0.970 | | | 20 | 3-546-2 | KTH-2229 | | 1 |
| 2985-6-16 | | Plug, Crimp, Keyed 222° | M | Nickel | 2.480 | 0.970 | | | 20 | 3-546-2 | KTH-2229 | | 1 |
| 2985-6-6 | | Plug, Crimp, Keyed 102° | M | Nickel | 2.480 | 0.970 | | | 20 | 3-546-2 | KTH-2229 | | 1 |
| 2985-7-1 | | Plug, Crimp, Keyed 42° | M | Nickel | 2.290 | 0.960 | | | 17 | 3-546-2 | KTH-2231 | | 1 |
| 2985-7-11 | | Plug, Crimp, Keyed 162° | M | Nickel | 2.290 | 0.960 | | | 17 | 3-546-2 | KTH-2231 | | 1 |
| 2985-7-16 | | Plug, Crimp, Keyed 222° | M | Nickel | 2.290 | 0.960 | | | 17 | 3-546-2 | KTH-2231 | | 1 |
| 2985-7-6 | | Plug, Crimp, Keyed 102° | M | Nickel | 2.290 | 0.960 | | | 17 | 3-546-2 | KTH-2231 | | 1 |
| 823-2-9 | | Jack, Crimp | F | Nickel | 1.670 | 0.730 | | | 19 | 3-546-2 | KTH-2213 | | 2 |
| KG-81-02 | | Dust Cap & Chain | F | Silver | 1.060 | 0.750 | 3.500 | 0.144 | | | | | N/S |

| Item Number | Military PN | Product Description | Gender | Finish | Dimensions | | | | Cable Group | Cable Procedure | Crimp Die | Mounting Hole | Figure # |
|-------------|-------------|--------------------------------|--------|--------|------------|-------|-------|-------|-------------|-----------------|-----------|---------------|----------|
| | | | | | A | B | C | D | | | | | |
| 826-10-9 | | Plug, Crimp, Angle | M | Nickel | 1.470 | 2.250 | 1.861 | 1.140 | 19 | 3-546-2 | KTH-2213 | | 3 |
| 826-12-9 | | Plug, Crimp, Angle | M | Nickel | 1.500 | 2.300 | 1.850 | 1.200 | 20 | 3-546-2 | KTH-2229 | | 3 |
| 826-8-9 | | Plug, Crimp, Angle | M | Nickel | 1.470 | 2.090 | 1.710 | 1.140 | 16 | 3-546-2 | KTH-2211 | | 3 |
| 826-9-9 | | Plug, Crimp, Angle | M | Nickel | 1.470 | 2.150 | 1.710 | 1.140 | 18 | 3-546-2 | KTH-2212 | | 3 |
| 2986-1-16 | | Plug, Crimp, Angle, Keyed 222° | M | Nickel | 2.060 | 2.470 | 1.990 | 1.700 | 5 | CP-5402 | KTH-2177 | | 3 |
| 2986-1-6 | | Plug, Crimp, Angle, Keyed 102° | M | Nickel | 2.060 | 2.470 | 1.990 | 1.700 | 5 | CP-5402 | KTH-2177 | | 3 |
| 2986-3-1 | | Plug, Crimp, Angle, Keyed 42° | M | Nickel | 2.030 | 2.340 | 1.860 | 1.700 | 19 | 3-546-2 | KTH-2213 | | 3 |
| 2986-3-11 | | Plug, Crimp, Angle, Keyed 162° | M | Nickel | 2.030 | 2.340 | 1.860 | 1.700 | 19 | 3-546-2 | KTH-2213 | | 3 |
| 2986-3-16 | | Plug, Crimp, Angle, Keyed 222° | M | Nickel | 2.030 | 2.340 | 1.860 | 1.700 | 19 | 3-546-2 | KTH-2213 | | 3 |
| 2986-3-6 | | Plug, Crimp, Angle, Keyed 102° | M | Nickel | 2.030 | 2.340 | 1.860 | 1.700 | 19 | 3-546-2 | KTH-2213 | | 3 |
| 2986-4-1 | | Plug, Crimp, Angle, Keyed 42° | M | Nickel | 2.100 | 2.310 | 1.860 | 1.700 | 20 | 3-546-2 | KTH-2229 | | 3 |
| 2986-4-11 | | Plug, Crimp, Angle, Keyed 162° | M | Nickel | 2.100 | 2.310 | 1.860 | 1.700 | 20 | 3-546-2 | KTH-2229 | | 3 |
| 2986-4-16 | | Plug, Crimp, Angle, Keyed 222° | M | Nickel | 2.100 | 2.310 | 1.860 | 1.700 | 20 | 3-546-2 | KTH-2229 | | 3 |
| 2986-4-6 | | Plug, Crimp, Angle, Keyed 102° | M | Nickel | 2.100 | 2.310 | 1.860 | 1.700 | 20 | 3-546-2 | KTH-2229 | | 3 |
| 821-2-9 | | Jack, Panel | F | Nickel | 1.550 | 0.650 | 0.800 | N/A | E1 | CP-5406 | KTH-2102 | | 4 |
| 821-3-9 | | Jack, Panel | F | Nickel | 1.740 | 0.840 | 0.690 | N/A | 5 | CP-5402 | KTH-2177 | | 4 |
| 821-4-9 | | Jack, Panel | F | Nickel | 1.570 | 0.846 | 0.685 | N/A | 18 | 3-546-2 | KTH-2212 | | 4 |
| 821-5-9 | | Jack, Panel | F | Nickel | 1.670 | 0.846 | 0.685 | N/A | 19 | 3-546-2 | KTH-2213 | | 4 |
| 821-6-9 | | Jack, Panel | F | Nickel | 1.740 | 0.845 | 0.685 | N/A | 20 | 3-546-2 | KTH-2229 | | 4 |
| 821-7-9 | | Jack, Panel | F | Nickel | 1.520 | 0.790 | 0.685 | N/A | 16 | 3-546-2 | KTH-2211 | | 4 |
| 2981-1-1 | | Jack, Panel, Keyed 42° | F | Nickel | 2.110 | 1.250 | 0.080 | 0.050 | 5 | CP-5402 | KTH-2177 | | 4 |
| 2981-1-11 | | Jack, Panel, Keyed 162° | F | Nickel | 2.110 | 1.250 | 0.080 | 0.050 | 5 | CP-5402 | KTH-2177 | | 4 |
| 2981-11-1 | | Jack, Panel, Keyed 42° | F | Nickel | 2.150 | 1.250 | 0.080 | 0.050 | 20 | 3-546-2 | KTH-2229 | | 4 |
| 2981-11-11 | | Jack, Panel, Keyed 162° | F | Nickel | 2.150 | 1.250 | 0.080 | 0.050 | 20 | 3-546-2 | KTH-2229 | | 4 |
| 2981-11-16 | | Jack, Panel, Keyed 222° | F | Nickel | 2.150 | 1.250 | 0.080 | 0.050 | 20 | 3-546-2 | KTH-2229 | | 4 |
| 2981-1-16 | | Jack, Panel, Keyed 222° | F | Nickel | 2.110 | 1.250 | 0.080 | 0.050 | 5 | CP-5402 | KTH-2177 | | 4 |
| 2981-11-6 | | Jack, Panel, Keyed 102° | F | Nickel | 2.150 | 1.250 | 0.080 | 0.050 | 20 | 3-546-2 | KTH-2229 | | 4 |
| 2981-1-6 | | Jack, Panel, Keyed 102° | F | Nickel | 2.110 | 1.250 | 0.080 | 0.050 | 5 | CP-5402 | KTH-2177 | | 4 |
| 2981-3-1 | | Jack, Panel, Keyed 42° | F | Nickel | 2.010 | 1.250 | 0.080 | 0.050 | 1 | CP-5402 | KTH-2101 | | 4 |
| 2981-3-11 | | Jack, Panel, Keyed 162° | F | Nickel | 2.010 | 1.250 | 0.080 | 0.050 | 1 | CP-5402 | KTH-2101 | | 4 |
| 2981-3-16 | | Jack, Panel, Keyed 222° | F | Nickel | 2.010 | 1.250 | 0.080 | 0.050 | 1 | CP-5402 | KTH-2101 | | 4 |
| 2981-3-6 | | Jack, Panel, Keyed 102° | F | Nickel | 2.010 | 1.250 | 0.080 | 0.050 | 1 | CP-5402 | KTH-2101 | | 4 |
| 2981-5-1 | | Jack, Panel, Keyed 42° | F | Nickel | 2.065 | 1.250 | 0.080 | 0.050 | 19 | 3-546-2 | KTH-2213 | | 4 |
| 2981-5-11 | | Jack, Panel, Keyed 162° | F | Nickel | 2.065 | 1.250 | 0.080 | 0.050 | 19 | 3-546-2 | KTH-2213 | | 4 |
| 2981-5-16 | | Jack, Panel, Keyed 222° | F | Nickel | 2.065 | 1.250 | 0.080 | 0.050 | 19 | 3-546-2 | KTH-2213 | | 4 |
| 2981-5-6 | | Jack, Panel, Keyed 102° | F | Nickel | 2.065 | 1.250 | 0.080 | 0.050 | 19 | 3-546-2 | KTH-2213 | | 4 |
| 2981-7-1 | | Jack, Panel, Keyed 42° | F | Nickel | 2.065 | 1.250 | 0.080 | 0.050 | 19 | 3-546-2 | KTH-2213 | | 4 |
| 2981-7-11 | | Jack, Panel, Keyed 162° | F | Nickel | 2.065 | 1.250 | 0.080 | 0.050 | 19 | 3-546-2 | KTH-2213 | | 4 |
| 2981-7-16 | | Jack, Panel, Keyed 222° | F | Nickel | 2.065 | 1.250 | 0.080 | 0.050 | 19 | 3-546-2 | KTH-2213 | | 4 |
| 2981-7-6 | | Jack, Panel, Keyed 102° | F | Nickel | 2.065 | 1.250 | 0.080 | 0.050 | 19 | 3-546-2 | KTH-2213 | | 4 |
| 2981-8-1 | | Jack, Panel, Keyed 42° | F | Nickel | 2.010 | 1.250 | 0.080 | 0.050 | 16 | 3-546-2 | KTH-2211 | | 4 |
| 2981-8-11 | | Jack, Panel, Keyed 162° | F | Nickel | 2.010 | 1.250 | 0.080 | 0.050 | 16 | 3-546-2 | KTH-2211 | | 4 |
| 2981-8-16 | | Jack, Panel, Keyed 222° | F | Nickel | 2.010 | 1.250 | 0.080 | 0.050 | 16 | 3-546-2 | KTH-2211 | | 4 |
| 2981-8-6 | | Jack, Panel, Keyed 102° | F | Nickel | 2.010 | 1.250 | 0.080 | 0.050 | 16 | 3-546-2 | KTH-2211 | | 4 |

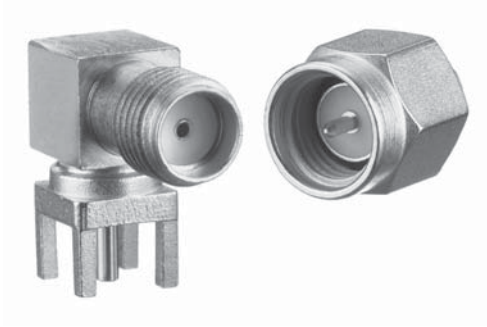

- 50 Ohm Nominal Impedance.
- Semi-precision, sub-miniature connectors with threaded interface.
- Excellent electrical performance.
- Commercial and Military-Specified versions.
- Available for semi-rigid, standard, flexible cables and receptacles.
- Frequency Range: Up to 18 GHz

SPECIFICATIONS

MATERIAL

| | |
|--------------------------------|---------------------------------------|
| Body: | Brass or Stainless Steel |
| Crimp Sleeves: Copper Alloy | Commercial Bronze or Copper Alloy |
| Center Contacts: | Brass (Male) Copper Alloy (Female) |
| Insulators: | PTFE |
| Gaskets & Seals: | Silicone Rubber |

FINISHES

| | |
|------------------|--------------------|
| Body: | Gold or Passivated |
| Center Contacts: | Gold |

ELECTRICAL

| | |
|------------------|----------------------|
| Impedance: | 50 Ohms |
| Frequency Range: | DC to 18 GHz |
| Voltage Rating: | 355 to 500 Volts RMS |
| VSWR: | Dependent on Cable |
| Insertion Loss: | Dependent on Cable |

MECHANICAL

| | |
|------------------|---|
| Life: | 500 Cycles |
| Cable Retention: | 10 to 60 Pounds (Dependent on Cable) |

ENVIRONMENTAL

| | |
|----------------------|--|
| Temperature Range: | -65° C to +165° C -65° C to +125° C (Epoxy Connectors) |
| Vibration: | MIL-STD-202, Method 204, Condition D |
| Shock: | MIL-STD-202, Method 213, Condition I |
| Corrosion: | MIL-STD-202, Method 101, Condition B |
| Moisture Resistance: | MIL-STD-202, Method 106 |

INTERFACE DIMENSIONS

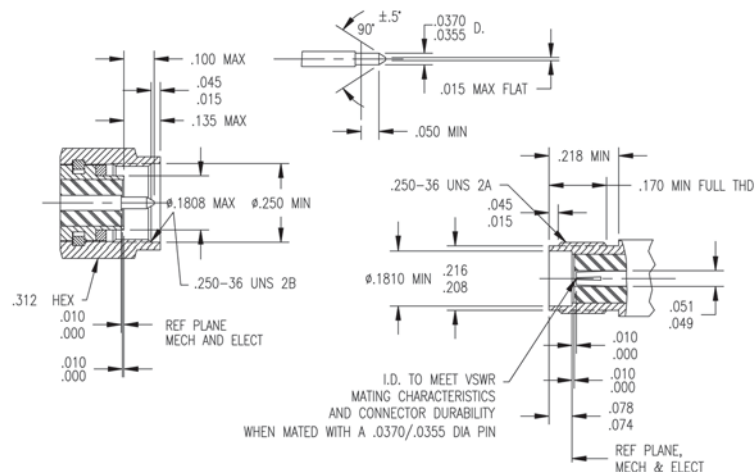

SMA SERIES

CABLE JACKS, SOLDER TYPE - SEMI-RIGID CABLE



FIGURE 1

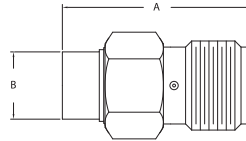

FIGURE 2



FIGURE 3

CABLE PLUGS, SOLDER TYPE - SEMI-RIGID CABLE

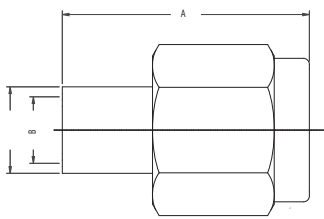

FIGURE 4

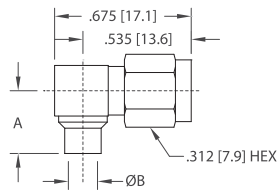

FIGURE 5



FIGURE 6

CABLE JACKS, CLAMP TYPE - FLEXIBLE CABLE

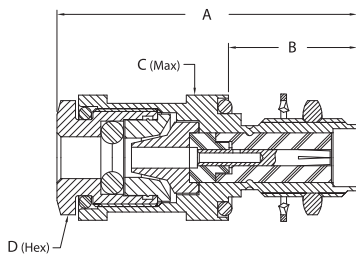

FIGURE 7



FIGURE 8

| Item Number | Military PN | Product Description | Gender | Finish | Dimensions | | | | | Cable Group | Cable Procedure | Crimp Die | Mounting Hole | Figure # |
|---------------|----------------|-----------------------------|--------|------------|------------|-------|-------|-------|-------|-------------|-----------------|-----------|---------------|----------|
| | | | | | A | B | C | D | T | | | | | |
| 872-57-3 | | Jack, Direct Solder, Bulkhd | F | Passivated | 0.640 | 0.410 | 0.380 | 0.090 | 0.113 | 50 | 3-481 | | AN | 1 |
| 872-37-3 | M39012/83-3008 | Jack, Direct Solder, Bulkhd | F | Passivated | 0.640 | 0.410 | 0.440 | 0.144 | 0.250 | 49 | 3-482 | | AN | 1 |
| 872-56-2 | | Jack, Direct Solder, Bulkhd | F | Gold | 0.640 | 0.410 | 0.440 | 0.144 | 0.113 | 49 | 3-482 | | AN | 1 |
| 872-36-3 | M39012/83-3007 | Jack, Direct Solder, Bulkhd | F | Passivated | 0.640 | 0.410 | 0.440 | 0.090 | 0.113 | 50 | CP-3800-1 | | AN | 1 |
| 878-2-3 | | Dust Cap & Chain | M | Passivated | 0.430 | 0.302 | 0.140 | 2.250 | | | | | | N/S |
| 351-500-0850H | | Jack, Solder | F | Gold/Brass | 0.500 | 0.120 | | | | 48 | CAP5-02 | | | 2 |
| 351-500-1410H | | Jack, Solder | F | Gold/Brass | 0.500 | 0.180 | | | | 49 | CAP5-02 | | | 2 |
| 873-19-3 | M39012/81-3008 | Jack, Direct Solder | F | Passivated | 0.520 | 0.180 | | | | 49 | 3-482 | | | 2 |
| 251-575-0850G | | Jack, Bulkhd, Solder | F | Gold | 0.750 | 0.415 | 0.437 | 0.090 | 0.093 | 48 | CAP5-02 | | R | 3 |
| 351-575-0850H | | Jack, Bulkhd, Solder | F | Gold/Brass | 0.750 | 0.450 | 0.312 | 0.090 | 0.093 | 48 | CAP5-02 | | R | 3 |
| 251-575-1410G | | Jack, Bulkhd, Solder | F | Gold | 0.750 | 0.415 | 0.437 | 0.144 | 0.093 | 49 | CAP5-02 | | R | 3 |
| 351-575-1410H | | Jack, Bulkhd, Solder | F | Gold/Brass | 0.750 | 0.450 | 0.312 | 0.144 | 0.093 | 49 | CAP5-02 | | R | 3 |
| 872-47-3 | | Jack, Clamp, Bulkhd | F | Gold | 0.960 | 0.406 | 0.390 | 0.066 | 0.113 | 3 | 3-515 | | AN | 7 |

| Item Number | Military PN | Product Description | Gender | Finish | Dimensions | | | | Cable Group | Cable Procedure | Crimp Die | Mounting Hole | Figure # |
|---------------|----------------|-----------------------------------|--------|------------|------------|-------|-------|-------|-------------|-----------------|-----------|---------------|----------|
| | | | | | A | B | C | D | | | | | |
| 250-500-0850G | | Plug, Solder | M | Gold | 0.440 | 0.090 | | | 48 | CAP5-02 | | | 4 |
| 250-500-0853G | | Plug, Solder | M | Gold | 0.330 | 0.090 | | | 48 | CAP5-02 | | | 4 |
| 250-500-0858G | | Plug, Solder, Insulator Assembled | M | Gold | 0.440 | 0.090 | | | 48 | CAP5-02 | | | 4 |
| 350-500-0850H | | Plug, Solder | M | Gold | 0.440 | 0.090 | | | 48 | CAP5-02 | | | 4 |
| 350-500-0858H | | Plug, Solder, Insulator Assembled | M | Gold | 0.440 | 0.090 | | | 48 | CAP5-02 | | | 4 |
| 250-500-0850P | | Plug, Solder | M | Passivated | 0.440 | 0.090 | | | 48 | CAP5-02 | | | 4 |
| 250-500-0853P | | Plug, Solder | M | Passivated | 0.330 | 0.090 | | | 48 | CAP5-02 | | | 4 |
| 250-500-0858P | | Plug, Solder, Insulator Assembled | M | Passivated | 0.440 | 0.090 | | | 48 | CAP5-02 | | | 4 |
| 250-500-1410G | | Plug, Solder, w/o Center Contact | M | Gold | 0.330 | 0.144 | | | 49 | CAP5-01 | | | 4 |
| 350-500-1410H | | Plug, Solder, w/o Center Contact | M | Gold | 0.330 | 0.144 | | | 49 | CAP5-01 | | | 4 |
| 250-500-1411G | | Plug, Solder, w/o Center Contact | M | Gold | 0.440 | 0.144 | | | 49 | CAP5-02 | | | 4 |
| 250-500-1412G | | Plug, Solder | M | Gold | 0.440 | 0.144 | | | 49 | CAP5-02 | | | 4 |
| 250-500-1413G | | Plug, Solder | M | Gold | 0.330 | 0.144 | | | 49 | CAP5-02 | | | 4 |
| 250-500-1418G | | Plug, Solder, Insulator Assembled | M | Gold | 0.440 | 0.144 | | | 49 | CAP5-02 | | | 4 |
| 350-500-1411H | | Plug, Solder, w/o Center Contact | M | Gold | 0.440 | 0.144 | | | 49 | CAP5-02 | | | 4 |
| 350-500-1412H | | Plug, Solder | M | Gold | 0.440 | 0.144 | | | 49 | CAP5-02 | | | 4 |
| 350-500-1418H | | Plug, Solder, Insulator Assembled | M | Gold | 0.440 | 0.144 | | | 49 | CAP5-02 | | | 4 |
| 250-500-1410P | | Plug, Solder, w/o Center Contact | M | Passivated | 0.330 | 0.144 | | | 49 | CAP5-01 | | | 4 |
| 250-500-1411P | | Plug, Solder, w/o Center Contact | M | Passivated | 0.440 | 0.144 | | | 49 | CAP5-02 | | | 4 |
| 250-500-1412P | | Plug, Solder | M | Passivated | 0.440 | 0.144 | | | 49 | CAP5-02 | | | 4 |
| 250-500-1413P | | Plug, Solder | M | Passivated | 0.330 | 0.144 | | | 49 | CAP5-02 | | | 4 |
| 250-500-1418P | | Plug, Solder, Insulator Assembled | M | Passivated | 0.440 | 0.144 | | | 49 | CAP5-02 | | | 4 |
| 875-81-17 | M39012/55-3007 | Plug, Conventional | M | Passivated | 0.990 | 0.312 | 0.400 | | B1 | 3-559 | | | 4 |
| 875-82-17 | M39012/55-3009 | Plug, Conventional | M | Passivated | 0.990 | 0.312 | 0.400 | | DE | 3-519 | | | 4 |
| 875-82-3 | M39012/55-3109 | Plug, Conventional | M | Passivated | 0.990 | 0.312 | 0.400 | | DE | 3-519 | | | 4 |
| 875-86-3 | M39012/55-3130 | Plug, Conventional | M | Passivated | 0.990 | 0.312 | 0.400 | | 3 | 3-519 | | | 4 |
| 252-500-1410G | | Plug, Angle, Solder | M | Gold | 0.310 | 0.144 | | | 49 | CAP5-03 | | | 5 |
| 352-500-1410H | | Plug, Angle, Solder | M | Gold | 0.310 | 0.144 | | | 49 | CAP5-03 | | | 5 |
| 252-500-1410P | | Plug, Angle, Solder | M | Passivated | 0.310 | 0.144 | | | 49 | CAP5-03 | | | 5 |
| 252-500-0850G | | Plug, Angle, Solder | M | Gold | 0.310 | 0.090 | | | 48 | CAP5-03 | | | 5 |
| 352-500-0850H | | Plug, Angle, Solder | M | Gold | 0.310 | 0.090 | | | 48 | CAP5-03 | | | 5 |
| 252-500-0850P | | Plug, Angle, Solder | M | Passivated | 0.310 | 0.090 | | | 48 | CAP5-03 | | | 5 |
| 875-59-3 | | Plug, Direct Solder | M | Passivated | 0.440 | 0.312 | | | 49 | 3-302 | | | 6 |
| 875-107-3 | | Plug, Direct Solder | M | Passivated | 0.440 | 0.312 | | | 49 | 3-303 | | | 6 |
| 875-58-3 | | Plug, Direct Solder | M | Passivated | 0.440 | 0.312 | | | 49 | 3-303 | | | 6 |
| 875-69-3 | M39012/79-3107 | Plug, Direct Solder | M | Passivated | 0.430 | 0.310 | | | 50 | 3-481 | | | 6 |
| 875-70-17 | M39012/79-3008 | Plug, Direct Solder | M | Passivated | 0.430 | 0.310 | | | 49 | 3-482 | | | 6 |
| 875-70-3 | M39012/79-3108 | Plug, Direct Solder | M | Passivated | 0.430 | 0.310 | | | 49 | 3-482 | | | 6 |
| 876-62-17 | M39012/56-3030 | Plug, Conventional, Angle | M | Passivated | 1.040 | 0.700 | 0.380 | 0.860 | 3 | 3-519 | | | 8 |
| 876-60-3 | M39012/56-3107 | Plug, Conventional, Angle | M | | 1.040 | 0.700 | 0.380 | 0.860 | B1 | 3-559 | | | 8 |
| 876-49-3 | M39012/80-3108 | Plug, Direct Solder, Angle | M | Passivated | 0.650 | 0.540 | 0.180 | 0.510 | 49 | 3-482 | | | N/S |
| 876-62-3 | M39012/56-3130 | Plug, Conventional, Angle | M | Passivated | 1.040 | 0.700 | 0.380 | 0.860 | 3 | 3-519 | | | 8 |
| 876-61-17 | M39012/56-3009 | Plug, Angle, Conventional | M | Passivated | 1.040 | 0.700 | 0.380 | 0.860 | DE | 3-519 | | | 8 |

JACK

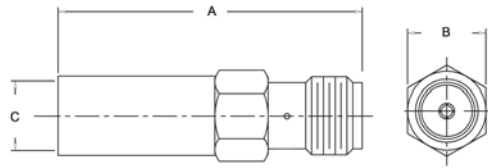

FIGURE 9

BULKHEAD JACK

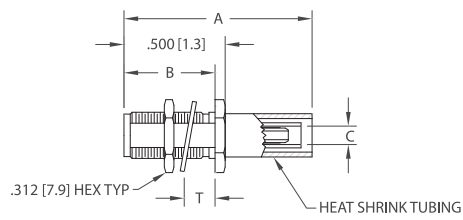

FIGURE 10

PANEL JACKS

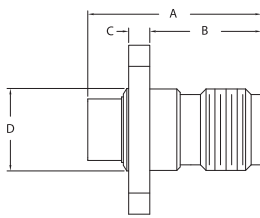

FIGURE 11

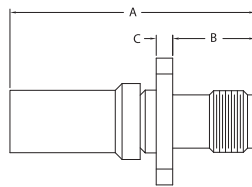

FIGURE 12

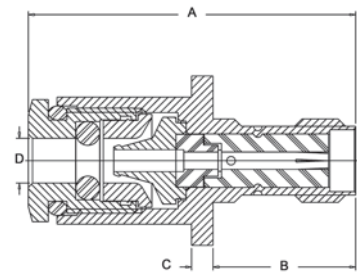

FIGURE 13

| Item Number | Military PN | Product Description | Gender | Finish | Dimensions | | | | Cable Group | Cable Procedure | Crimp Die | Mounting Hole | Figure # |
|---------------|----------------|----------------------------|--------|------------|------------|-------|-------|-------|-------------|-----------------|-----------|---------------|----------|
| | | | | | A | B | C | D | | | | | |
| 351-900-0631H | | Jack, Crimp | F | Gold | 1.125 | 0.142 | | | 3 | CAP9-04 | KTH-2015 | | 9 |
| 351-900-0631N | | Jack, Crimp | F | Nickel | 1.125 | 0.142 | | | 3 | CAP9-04 | KTH-2015 | | 9 |
| 351-900-0630H | | Jack, Crimp | F | Gold | 1.125 | 0.128 | | | B | CAP9-04 | KTH-2011 | | 9 |
| 351-900-0630N | | Jack, Crimp | F | Nickel | 1.125 | 0.128 | | | B | CAP9-04 | KTH-2011 | | 9 |
| 351-900-1160H | | Jack, Crimp | F | Gold | 1.125 | 0.206 | | | D | CAP9-04 | KTH-2001 | | 9 |
| 351-900-1160N | | Jack, Crimp | F | Nickel | 1.125 | 0.206 | | | D | CAP9-04 | KTH-2001 | | 9 |
| 873-1-3 | M39012/56B3114 | Jack, Crimp | F | Passivated | 0.950 | 0.250 | 0.210 | | D | CP-432 | KTH-2001 | | 9 |
| 351-900-1161H | | Jack, Crimp | F | Gold | 1.125 | 0.219 | | | E | CAP9-04 | KTH-2001 | | 9 |
| 351-900-1161N | | Jack, Crimp | F | Nickel | 1.125 | 0.219 | | | E | CAP9-04 | KTH-2001 | | 9 |
| 873-3-1 | | Jack, Crimp | F | Gold | 0.950 | 0.250 | 0.220 | | E | CP-432 | KTH-2001 | | 9 |
| 873-18 | M39012/57-4502 | Jack, Crimp | F | Gold | 0.970 | 0.220 | | | E1 | CP-493 | KTH-2113 | | 9 |
| 873-18-3 | M39012/57-3502 | Jack, Crimp | F | Passivated | 0.970 | 0.220 | | | E2 | CP-493 | KTH-2113 | | 9 |
| 251-975-0631G | | Jack, Crimp, Bulkhd | F | Gold | 0.875 | 0.450 | 0.142 | | 3 | CAP9-04 | KTH-2015 | R | 10 |
| 351-975-0631H | | Jack, Crimp, Bulkhd | F | Gold | 0.875 | 0.450 | 0.142 | | 3 | CAP9-04 | KTH-2015 | R | 10 |
| 351-975-0631N | | Jack, Crimp, Bulkhd | F | Nickel | 0.875 | 0.450 | 0.142 | | 3 | CAP9-04 | KTH-2015 | R | 10 |
| 251-975-0631P | | Jack, Crimp, Bulkhd | F | Passivated | 0.875 | 0.450 | 0.142 | | 3 | CAP9-04 | KTH-2015 | R | 10 |
| 251-975-0630G | | Jack, Crimp, Bulkhd | F | Gold | 0.875 | 0.450 | 0.128 | | B | CAP9-04 | KTH-2011 | R | 10 |
| 351-975-0630H | | Jack, Crimp, Bulkhd | F | Gold | 0.875 | 0.450 | 0.128 | | B | CAP9-04 | KTH-2011 | R | 10 |
| 351-975-0630N | | Jack, Crimp, Bulkhd | F | Nickel | 0.875 | 0.450 | 0.128 | | B | CAP9-04 | KTH-2011 | R | 10 |
| 251-975-0630P | | Jack, Crimp, Bulkhd | F | Passivated | 0.875 | 0.450 | 0.128 | | B | CAP9-04 | KTH-2011 | R | 10 |
| 251-975-1160G | | Jack, Crimp, Bulkhd | F | Gold | 0.875 | 0.450 | 0.206 | | D | CAP9-04 | KTH-2001 | R | 10 |
| 351-975-1160H | | Jack, Crimp, Bulkhd | F | Gold | 0.875 | 0.450 | 0.206 | | D | CAP9-04 | KTH-2001 | R | 10 |
| 351-975-1160N | | Jack, Crimp, Bulkhd | F | Nickel | 0.875 | 0.450 | 0.206 | | D | CAP9-04 | KTH-2001 | R | 10 |
| 251-975-1160P | | Jack, Crimp, Bulkhd | F | Passivated | 0.875 | 0.450 | 0.206 | | D | CAP9-04 | KTH-2001 | R | 10 |
| 251-975-1161G | | Jack, Crimp, Bulkhd | F | Gold | 0.875 | 0.450 | 0.219 | | E | CAP9-04 | KTH-2001 | R | 10 |
| 351-975-1161H | | Jack, Crimp, Bulkhd | F | Gold | 0.875 | 0.450 | 0.219 | | E | CAP9-04 | KTH-2001 | R | 10 |
| 351-975-1161N | | Jack, Crimp, Bulkhd | F | Nickel | 0.875 | 0.450 | 0.219 | | E | CAP9-04 | KTH-2001 | R | 10 |
| 251-975-1161P | | Jack, Crimp, Bulkhd | F | Passivated | 0.875 | 0.450 | 0.219 | | E | CAP9-04 | KTH-2001 | R | 10 |
| 871-38-3 | M39012/82-3008 | Jack, Direct Solder, Panel | F | Passivated | 0.520 | 0.330 | 0.070 | 0.250 | 49 | 3-482 | | C | 11 |
| 871-68-1 | | Jack, Direct Solder, Panel | F | Gold | 0.530 | 0.300 | 0.075 | 0.375 | | 3-652 | | C | 11 |
| 871-59-3 | | Jack, Crimp, Panel, W/P | F | Passivated | 0.967 | 0.325 | 0.070 | | 16 | 3-515 | KTH-2207 | C | 12 |
| 871-13 | M39012/58B4012 | Jack, Crimp, Panel | F | | 0.890 | 0.330 | 0.070 | | B1 | CP-439 | KTH-2081 | | 12 |
| 871-57-3 | | Jack, Conventional, Panel | F | Passivated | 0.950 | 0.420 | 0.060 | 0.130 | 3 | 3-515 | | C | 13 |

PANEL JACKS

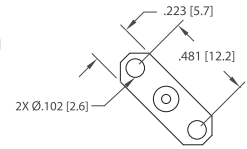
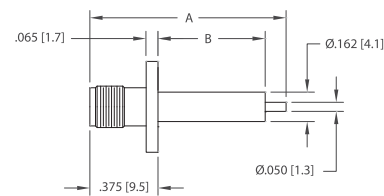
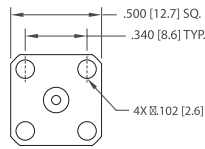
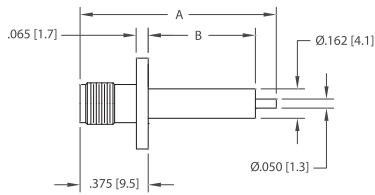

FIGURE 14

FIGURE 15

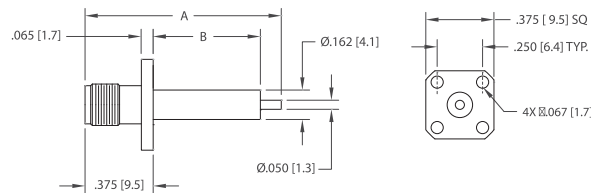

FIGURE 16

| Item Number | Military PN | Product Description | Gender | Finish | Dimensions | | | | Cable Group | Cable Procedure | Crimp Die | Mounting Hole | Figure # |
|---------------|-------------|---------------------------|--------|------------|------------|-------|---|---|-------------|-----------------|-----------|---------------|----------|
| | | | | | A | B | C | D | | | | | |
| 251-065-0040G | | Captured, Jack, Panel | F | Gold | 1.080 | 0.590 | | | | | | C | 14 |
| 251-065-0041G | | Non-Captured, Jack, Panel | F | Gold | 1.080 | 0.590 | | | | | | C | 14 |
| 351-065-0040H | | Captured, Jack, Panel | F | Gold | 1.080 | 0.590 | | | | | | C | 14 |
| 351-065-0041H | | Non-Captured, Jack, Panel | F | Gold | 1.080 | 0.590 | | | | | | C | 14 |
| 351-065-0040N | | Captured, Jack, Panel | F | Nickel | 1.080 | 0.590 | | | | | | C | 14 |
| 351-065-0041N | | Non-Captured, Jack, Panel | F | Nickel | 1.080 | 0.590 | | | | | | C | 14 |
| 251-065-0040P | | Captured, Jack, Panel | F | Passivated | 1.080 | 0.590 | | | | | | C | 14 |
| 251-065-0041P | | Non-Captured, Jack, Panel | F | Passivated | 1.080 | 0.590 | | | | | | C | 14 |
| 251-066-0040G | | Captured, Jack, Panel | F | Gold | 1.080 | 0.590 | | | | | | D | 15 |
| 251-066-0041G | | Non-Captured, Jack, Panel | F | Gold | 1.080 | 0.590 | | | | | | D | 15 |
| 351-066-0040H | | Captured, Jack, Panel | F | Gold | 1.080 | 0.590 | | | | | | D | 15 |
| 351-066-0041H | | Non-Captured, Jack, Panel | F | Gold | 1.080 | 0.590 | | | | | | D | 15 |
| 351-066-0040N | | Captured, Jack, Panel | F | Nickel | 1.080 | 0.590 | | | | | | D | 15 |
| 351-066-0041N | | Non-Captured, Jack, Panel | F | Nickel | 1.080 | 0.590 | | | | | | D | 15 |
| 251-066-0040P | | Captured, Jack, Panel | F | Passivated | 1.080 | 0.590 | | | | | | D | 15 |
| 251-066-0041P | | Non-Captured, Jack, Panel | F | Passivated | 1.080 | 0.590 | | | | | | D | 15 |
| 251-055-0040G | | Captured, Jack, Panel | F | Gold | 1.080 | 0.590 | | | | | | S | 16 |
| 251-055-0041G | | Non-Captured, Jack, Panel | F | Gold | 1.080 | 0.590 | | | | | | S | 16 |
| 351-055-0040H | | Captured, Jack, Panel | F | Gold | 1.080 | 0.590 | | | | | | S | 16 |
| 351-055-0041H | | Non-Captured, Jack, Panel | F | Gold | 1.080 | 0.590 | | | | | | S | 16 |
| 351-055-0040N | | Captured, Jack, Panel | F | Nickel | 1.080 | 0.590 | | | | | | S | 16 |
| 351-055-0041N | | Non-Captured, Jack, Panel | F | Nickel | 1.080 | 0.590 | | | | | | S | 16 |
| 251-055-0040P | | Captured, Jack, Panel | F | Passivated | 1.080 | 0.590 | | | | | | S | 16 |
| 251-055-0041P | | Non-Captured, Jack, Panel | F | Passivated | 1.080 | 0.590 | | | | | | S | 16 |

ANGLE PLUGS



FIGURE 17



FIGURE 18

| Item Number | Military PN | Product Description | Gender | Finish | Dimensions | | | | Cable Group | Cable Procedure | Crimp Die | Mounting Hole | Figure # |
|---------------|-------------|----------------------------------|--------|------------|------------|-------|-------|-------|-------------|-----------------|-----------|---------------|----------|
| | | | | | A | B | C | D | | | | | |
| 252-900-0631G | | Plug, Crimp, Angle | M | Gold | 1.00max | 0.142 | | | 3 | CAP9-05 | KTH-2015 | | 17 |
| 352-900-0631H | | Plug, Crimp, Angle | M | Gold | 1.00max | 0.142 | | | 3 | CAP9-05 | KTH-2015 | | 17 |
| 352-900-0631N | | Plug, Crimp, Angle | M | Nickel | 1.00max | 0.142 | | | 3 | CAP9-05 | KTH-2015 | | 17 |
| 252-900-0631P | | Plug, Crimp, Angle | M | Passivated | 1.00max | 0.142 | | | 3 | CAP9-05 | KTH-2015 | | 17 |
| 252-900-0630G | | Plug, Crimp, Angle | M | Gold | 1.00max | 0.128 | | | B | CAP9-05 | KTH-2011 | | 17 |
| 352-900-0630H | | Plug, Crimp, Angle | M | Gold | 1.00max | 0.128 | | | B | CAP9-05 | KTH-2011 | | 17 |
| 352-900-0630N | | Plug, Crimp, Angle | M | Nickel | 1.00max | 0.128 | | | B | CAP9-05 | KTH-2011 | | 17 |
| 252-900-0630P | | Plug, Crimp, Angle | M | Passivated | 1.00max | 0.128 | | | B | CAP9-05 | KTH-2011 | | 17 |
| 252-900-1160G | | Plug, Crimp, Angle | M | Gold | 1.00max | 0.206 | | | D | CAP9-05 | KTH-2001 | | 17 |
| 352-900-1160H | | Plug, Crimp, Angle | M | Gold | 1.00max | 0.206 | | | D | CAP9-05 | KTH-2001 | | 17 |
| 352-900-1160N | | Plug, Crimp, Angle | M | Nickel | 1.00max | 0.206 | | | D | CAP9-05 | KTH-2001 | | 17 |
| 252-900-1160P | | Plug, Crimp, Angle | M | Passivated | 1.00max | 0.206 | | | D | CAP9-05 | KTH-2001 | | 17 |
| 252-900-1161G | | Plug, Crimp, Angle | M | Gold | 1.00max | 0.219 | | | E | CAP9-05 | KTH-2001 | | 17 |
| 352-900-1161H | | Plug, Crimp, Angle | M | Gold | 1.00max | 0.219 | | | E | CAP9-05 | KTH-2001 | | 17 |
| 352-900-1161N | | Plug, Crimp, Angle | M | Nickel | 1.00max | 0.219 | | | E | CAP9-05 | KTH-2001 | | 17 |
| 252-900-1161P | | Plug, Crimp, Angle | M | Passivated | 1.00max | 0.219 | | | E | CAP9-05 | KTH-2001 | | 17 |
| 876-64-3 | | Plug, Crimp, Angle, Weatherproof | M | Passivated | 0.690 | 1.230 | 0.375 | 0.510 | 16 | 3-546-1 | KTH-2207 | | 18 |
| 876-72-3 | | Plug, Crimp, Angle, Weatherproof | M | Passivated | 0.750 | 1.300 | 0.380 | | 17 | 3-546-1 | KTH-2242 | | 18 |

Part # beginning with 25* - Stainless Steel Plating
 Part # beginning with 35* - Brass Plating

ANGLE JACKS



FIGURE 19

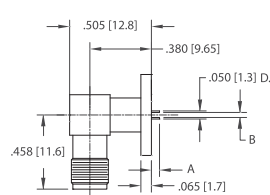

FIGURE 20

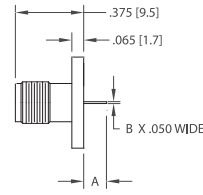

FIGURE 21

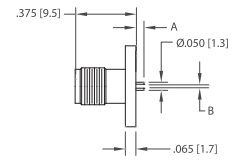

FIGURE 22

ADAPTERS



FIGURE 24



FIGURE 25

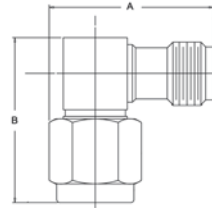
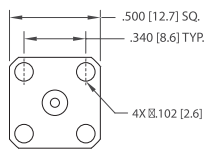

FIGURE 26



FIGURE 23



_1

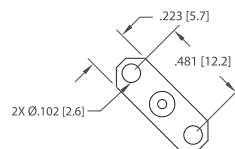

_2

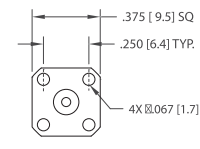

_3

| Item Number | Military PN | Product Description | Gender | Finish | Dimensions | | | | Cable Group | Cable Procedure | Crimp Die | Mounting Hole | Figure # |
|---------------|-------------|---------------------|--------|------------|------------|-------|---|---|-------------|-----------------|-----------|---------------|----------|
| | | | | | A | B | C | D | | | | | |
| 253-065-0000G | | Jack, Angle, Panel | F | Gold | 0.200 | 0.062 | | | | | | C | 19 |
| 353-065-0000H | | Jack, Angle, Panel | F | Gold | 0.200 | 0.062 | | | | | | C | 19 |
| 353-065-0000N | | Jack, Angle, Panel | F | Nickel | 0.200 | 0.062 | | | | | | C | 19 |
| 253-065-0000P | | Jack, Angle, Panel | F | Passivated | 0.200 | 0.062 | | | | | | C | 19 |
| 253-065-0024G | | Jack, Angle, Panel | F | Gold | 0.050 | 0.028 | | | | | | C | 20_1 |
| 253-065-0025G | | Jack, Angle, Panel | F | Gold | 0.050 | 0.036 | | | | | | C | 20_1 |
| 253-065-0023P | | Jack, Angle, Panel | F | Passivated | 0.050 | 0.018 | | | | | | C | 20_1 |
| 253-065-0024P | | Jack, Angle, Panel | F | Passivated | 0.050 | 0.028 | | | | | | C | 20_1 |
| 253-065-0025P | | Jack, Angle, Panel | F | Passivated | 0.050 | 0.036 | | | | | | C | 20_1 |
| 253-066-0022G | | Jack, Angle, Panel | F | Gold | 0.050 | 0.012 | | | | | | D | 20_2 |
| 253-066-0023G | | Jack, Angle, Panel | F | Gold | 0.050 | 0.018 | | | | | | D | 20_2 |
| 253-066-0024G | | Jack, Angle, Panel | F | Gold | 0.050 | 0.028 | | | | | | D | 20_2 |
| 253-066-0025G | | Jack, Angle, Panel | F | Gold | 0.050 | 0.036 | | | | | | D | 20_2 |
| 253-066-0022P | | Jack, Angle, Panel | F | Passivated | 0.050 | 0.012 | | | | | | D | 20_2 |
| 253-066-0023P | | Jack, Angle, Panel | F | Passivated | 0.050 | 0.018 | | | | | | D | 20_2 |
| 253-066-0024P | | Jack, Angle, Panel | F | Passivated | 0.050 | 0.028 | | | | | | D | 20_2 |
| 253-066-0025P | | Jack, Angle, Panel | F | Passivated | 0.050 | 0.036 | | | | | | D | 20_2 |
| 253-055-0022G | | Jack, Angle, Panel | F | Gold | 0.050 | 0.012 | | | | | | S | 20_3 |
| 253-055-0023G | | Jack, Angle, Panel | F | Gold | 0.050 | 0.018 | | | | | | S | 20_3 |
| 253-055-0024G | | Jack, Angle, Panel | F | Gold | 0.050 | 0.028 | | | | | | S | 20_3 |
| 253-055-0025G | | Jack, Angle, Panel | F | Gold | 0.050 | 0.036 | | | | | | S | 20_3 |
| 253-055-0022P | | Jack, Angle, Panel | F | Passivated | 0.050 | 0.012 | | | | | | S | 20_3 |
| 253-055-0023P | | Jack, Angle, Panel | F | Passivated | 0.050 | 0.018 | | | | | | S | 20_3 |
| 253-055-0024P | | Jack, Angle, Panel | F | Passivated | 0.050 | 0.028 | | | | | | S | 20_3 |

| Item Number | Military PN | Product Description | Gender | Finish | Dimensions | | | | Cable Group | Cable Procedure | Crimp Die | Mounting Hole | Figure # |
|---------------|-------------|---------------------------|--------|------------|------------|-------|-------|---|-------------|-----------------|-----------|---------------|----------|
| | | | | | A | B | C | D | | | | | |
| 253-055-0025P | | Jack, Angle, Panel | F | Passivated | 0.050 | 0.036 | | | | | S | 20_3 | |
| 251-065-0030G | | Captured, Jack, Panel | F | Gold | 0.100 | 0.005 | | | | | C | 21_1 | |
| 251-065-0031G | | Non-Captured, Jack, Panel | F | Gold | 0.100 | 0.005 | | | | | C | 21_1 | |
| 251-065-0030P | | Captured, Jack, Panel | F | Passivated | 0.100 | 0.005 | | | | | C | 21_1 | |
| 251-065-0031P | | Non-Captured, Jack, Panel | F | Passivated | 0.100 | 0.005 | | | | | C | 21_1 | |
| 251-066-0030G | | Captured, Jack, Panel | F | Gold | 0.100 | 0.005 | | | | | D | 21_2 | |
| 251-066-0031G | | Non-Captured, Jack, Panel | F | Gold | 0.100 | 0.005 | | | | | D | 21_2 | |
| 251-066-0030P | | Captured, Jack, Panel | F | Passivated | 0.100 | 0.005 | | | | | D | 21_2 | |
| 251-066-0031P | | Non-Captured, Jack, Panel | F | Passivated | 0.100 | 0.005 | | | | | D | 21_2 | |
| 251-055-0030G | | Captured, Jack, Panel | F | Gold | 0.100 | 0.005 | | | | | S | 21_3 | |
| 251-055-0031G | | Non-Captured, Jack, Panel | F | Gold | 0.100 | 0.005 | | | | | S | 21_3 | |
| 251-055-0030P | | Captured, Jack, Panel | F | Passivated | 0.100 | 0.005 | | | | | S | 21_3 | |
| 251-055-0031P | | Non-Captured, Jack, Panel | F | Passivated | 0.100 | 0.005 | | | | | S | 21_3 | |
| 251-065-0023G | | Jack, Panel | F | Gold | 0.050 | 0.018 | | | | | C | 22_1 | |
| 251-065-0024G | | Jack, Panel | F | Gold | 0.050 | 0.028 | | | | | C | 22_1 | |
| 251-065-0025G | | Jack, Panel | F | Gold | 0.050 | 0.036 | | | | | C | 22_1 | |
| 251-065-0023P | | Jack, Panel | F | Passivated | 0.050 | 0.018 | | | | | C | 22_1 | |
| 251-065-0024P | | Jack, Panel | F | Passivated | 0.050 | 0.028 | | | | | C | 22_1 | |
| 251-065-0025P | | Jack, Panel | F | Passivated | 0.050 | 0.036 | | | | | C | 22_1 | |
| 251-065-0022G | | Jack, Panel | F | Gold | 0.050 | 0.012 | | | | | C | 22_1 | |
| 251-065-0022P | | Jack, Panel | F | Passivated | 0.050 | 0.012 | | | | | C | 22_1 | |
| 251-066-0022G | | Jack, Panel | F | Gold | 0.050 | 0.012 | | | | | D | 22_2 | |
| 251-066-0023G | | Jack, Panel | F | Gold | 0.050 | 0.018 | | | | | D | 22_2 | |
| 251-066-0024G | | Jack, Panel | F | Gold | 0.050 | 0.028 | | | | | D | 22_2 | |
| 251-066-0025G | | Jack, Panel | F | Gold | 0.050 | 0.036 | | | | | D | 22_2 | |
| 251-066-0022P | | Jack, Panel | F | Passivated | 0.050 | 0.012 | | | | | D | 22_2 | |
| 251-066-0023P | | Jack, Panel | F | Passivated | 0.050 | 0.018 | | | | | D | 22_2 | |
| 251-066-0024P | | Jack, Panel | F | Passivated | 0.050 | 0.028 | | | | | D | 22_2 | |
| 251-066-0025P | | Jack, Panel | F | Passivated | 0.050 | 0.036 | | | | | D | 22_2 | |
| 251-055-0022G | | Jack, Panel | F | Gold | 0.050 | 0.012 | | | | | S | 22_3 | |
| 251-055-0023G | | Jack, Panel | F | Gold | 0.050 | 0.018 | | | | | S | 22_3 | |
| 251-055-0024G | | Jack, Panel | F | Gold | 0.050 | 0.028 | | | | | S | 22_3 | |
| 251-055-0025G | | Jack, Panel | F | Gold | 0.050 | 0.036 | | | | | S | 22_3 | |
| 251-055-0022P | | Jack, Panel | F | Passivated | 0.050 | 0.012 | | | | | S | 22_3 | |
| 251-055-0023P | | Jack, Panel | F | Passivated | 0.050 | 0.018 | | | | | S | 22_3 | |
| 251-055-0024P | | Jack, Panel | F | Passivated | 0.050 | 0.028 | | | | | S | 22_3 | |
| 251-055-0025P | | Jack, Panel | F | Passivated | 0.050 | 0.036 | | | | | S | 22_3 | |
| 253-065-0022G | | Jack, Panel | F | Gold | 0.050 | 0.012 | | | | | C | 23_1 | |
| 253-065-0023G | | Jack, Panel | F | Gold | 0.050 | 0.018 | | | | | C | 23_1 | |
| 253-065-0022P | | Jack, Panel | F | Passivated | 0.050 | 0.012 | | | | | C | 23_1 | |
| 877-120-5 | | Jack, Panel | F | Silver | 1.111 | 0.440 | 0.065 | | | | E | 23 | |
| 879-2-1 | | Within Series Adapter | M-M | Gold | 0.880 | | | | | | | 24 | |
| 879-2-3 | | Within Series Adapter | M-M | Passivated | 0.880 | | | | | | | 24 | |
| 879-3 | | Within Series Adapter | F-F | Gold | 0.500 | 0.250 | | | | | | 25 | |
| 879-3-3 | | Within Series Adapter | F-F | Passivated | 0.500 | 0.220 | | | | | | 25 | |
| 879-1-3 | | Within Series Adapter | M-F | Passivated | 0.650 | 0.630 | | | | | | 26 | |
| 879-1-9 | | Within Series Adapter | M-F | Nickel | 0.630 | 0.650 | | | | | | 26 | |

JACK

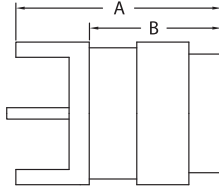

FIGURE 27

ANGLE JACKS

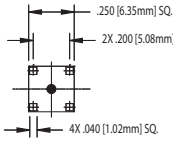
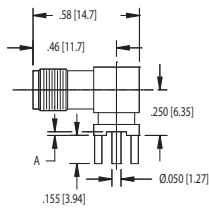

FIGURE 28

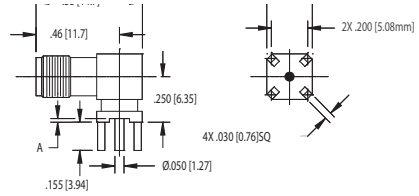

FIGURE 29

BULKHEAD RECEPTACLE

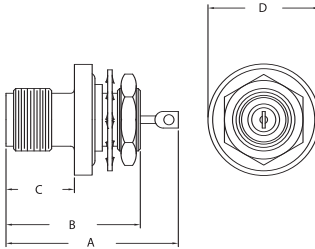

FIGURE 30

RECEPTACLE

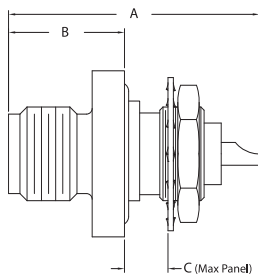

FIGURE 31

ANGLE RECEPTACLE

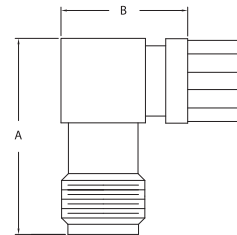

FIGURE 32

| Item Number | Military PN | Product Description | Gender | Finish | Dimensions | | | | Cable Group | Cable Procedure | Crimp Die | Mounting Hole | Figure # |
|---------------|----------------|------------------------|--------|------------|------------|-------|-------|-------|-------------|-----------------|-----------|---------------|----------|
| | | | | | A | B | C | D | | | | | |
| 351-085-0030H | | Jack, End Launch | F | Gold | 0.068 | 0.073 | | | | | | | N/S |
| 351-085-0040H | | Jack, End Launch | F | Gold | 0.068 | 0.083 | | | | | | | N/S |
| 351-060-0046H | | Jack, PCB | F | Gold | 0.550 | 0.395 | 0.020 | | | | | O | 27 |
| 251-060-0040G | | Jack, PCB | F | Gold | 0.530 | 0.375 | | | | | | T | 27 |
| 351-060-0040H | | Jack, PCB | F | Gold | 0.530 | 0.375 | | | | | | T | 27 |
| 877-114-4 | | Receptacle, PCB | F | Nickel | 0.565 | 0.425 | | | | | | | 27 |
| 877-86-1 | M39012/93-3001 | Receptacle, PCB | F | Passivated | 0.540 | 0.380 | | | | | | D | 27 |
| 877-92-1 | M39012/93-3002 | Receptacle, PCB | F | Gold | 0.500 | 0.380 | | | | | | D | 27 |
| 253-060-0040G | | Jack, PCB, Angle | F | Gold | | | | | | | | T | 28 |
| 353-060-0040H | | Jack, PCB, Angle | F | Gold | | | | | | | | T | 28 |
| 353-060-0046H | | Jack, PCB, Angle | F | Gold | 0.020 | | | | | | | O | 29 |
| 351-060-7540H | | Jack, PCB, Bulkhd | F | Gold | 0.562 | 0.415 | | | | | | T | N/S |
| 251-075-0000G | | Receptacle, Bulkhd | F | Gold | 0.668 | 0.450 | 0.312 | | | | | R | 30 |
| 251-075-0004G | | Receptacle, Bulkhd | F | Gold | 0.668 | 0.415 | 0.437 | | | | | R | 30 |
| 251-075-0000P | | Receptacle, Bulkhd | F | Passivated | 0.668 | 0.450 | 0.312 | | | | | R | 30 |
| 251-075-0004P | | Receptacle, Bulkhd | F | Passivated | 0.668 | 0.415 | 0.437 | | | | | R | 30 |
| 874-1 | M39012/61-4001 | Receptacle, Bulkhd | F | Gold | 0.670 | 0.500 | 0.312 | 0.430 | | | | | N/S |
| 874-11-3 | M39012/61-3002 | Receptacle, Bulkhd | F | Passivated | 0.660 | 0.290 | 0.290 | 0.060 | | | | | 30 |
| 874-4 | | Receptacle, Bulkhd | F | Gold | 0.680 | 0.530 | 0.270 | 0.440 | | | | | 30 |
| 874-2-3 | M39012/61-3002 | Receptacle | F | Passivated | 0.660 | 0.310 | 0.180 | | | | | | 31 |
| 877-93-1 | M39012/93-3003 | Receptacle | F | Gold | 0.470 | 0.380 | | | | | | D | N/S |
| 877-95-1 | M39012/94-3003 | Receptacle | F | Gold | 0.590 | 0.460 | | | | | | D | 32 |
| 877-87-1 | M39012/94-3001 | Receptacle, Angle, PCB | F | Passivated | 0.590 | 0.370 | | | | | | D | 32 |
| 877-94-1 | M39012/94-3002 | Receptacle, Angle, PCB | F | Gold | 0.590 | 0.380 | | | | | | D | 32 |

PLUGS

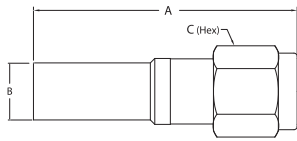

FIGURE 33



FIGURE 34

| Item Number | Military PN | Product Description | Gender | Finish | Dimensions | | | | Cable Group | Cable Procedure | Crimp Die | Mounting Hole | Figure # |
|---------------|----------------|---------------------------|--------|------------|----------------------|-------|-------|---|-------------|-----------------|-----------|---------------|----------|
| | | | | | A | B | C | D | | | | | |
| 250-900-0631G | | Plug, Crimp | M | Gold | 1.187 _{max} | 0.142 | | | 3 | CAP9-04 | KTH-2015 | | 33 |
| 350-900-0631H | | Plug, Crimp | M | Gold | 1.187 _{max} | 0.142 | | | 3 | CAP9-04 | KTH-2015 | | 33 |
| 350-900-0631N | | Plug, Crimp | M | Nickel | 1.187 _{max} | 0.142 | | | 3 | CAP9-04 | KTH-2015 | | 33 |
| 250-900-0631P | | Plug, Crimp | M | Passivated | 1.187 _{max} | 0.142 | | | 3 | CAP9-04 | KTH-2015 | | 33 |
| 875-92-3 | | Plug, Crimp, Weatherproof | M | Passivated | 1.040 | 0.215 | 0.310 | | 15 | 3-546-1 | KTH-2214 | | 33 |
| 875-91-3 | | Plug, Crimp, Weatherproof | M | Passivated | 1.010 | 0.248 | 0.312 | | 16 | 3-546-1 | KTH-2207 | | 33 |
| 875-100-3 | | Plug, Crimp, Weatherproof | M | Passivated | 1.010 | 0.299 | 0.312 | | 17 | 3-546-1 | KTH-2242 | | 33 |
| 875-101-3 | | Plug, Crimp, Weatherproof | M | Passivated | 0.930 | 0.147 | 0.312 | | 21 | 3-546 | KTH-2244 | | 33 |
| 250-900-0630G | | Plug, Crimp | M | Gold | 1.187 _{max} | 0.128 | | | B | CAP9-04 | KTH-2011 | | 33 |
| 350-900-0630H | | Plug, Crimp | M | Gold | 1.187 _{max} | 0.128 | | | B | CAP9-04 | KTH-2011 | | 33 |
| 350-900-0630N | | Plug, Crimp | M | Nickel | 1.187 _{max} | 0.128 | | | B | CAP9-04 | KTH-2011 | | 33 |
| 250-900-0630P | | Plug, Crimp | M | Passivated | 1.187 _{max} | 0.128 | | | B | CAP9-04 | KTH-2011 | | 33 |
| 875-105-3 | | Plug, Crimp, Weatherproof | M | Passivated | 0.944 | 0.120 | 0.310 | | B1 | 3-546-8 | KTH-2081 | | 33 |
| 250-900-1160G | | Plug, Crimp | M | Gold | 1.187 _{max} | 0.206 | | | D | CAP9-04 | KTH-2001 | | 33 |
| 350-900-1160H | | Plug, Crimp | M | Gold | 1.187 _{max} | 0.206 | | | D | CAP9-04 | KTH-2001 | | 33 |
| 350-900-1160N | | Plug, Crimp | M | Nickel | 1.187 _{max} | 0.206 | | | D | CAP9-04 | KTH-2001 | | 33 |
| 250-900-1160P | | Plug, Crimp | M | Passivated | 1.187 _{max} | 0.206 | | | D | CAP9-04 | KTH-2001 | | 33 |
| 250-900-1161G | | Plug, Crimp | M | Gold | 1.187 _{max} | 0.219 | | | E | CAP9-04 | KTH-2001 | | 33 |
| 350-900-1161H | | Plug, Crimp | M | Gold | 1.187 _{max} | 0.219 | | | E | CAP9-04 | KTH-2001 | | 33 |
| 350-900-1161N | | Plug, Crimp | M | Nickel | 1.187 _{max} | 0.219 | | | E | CAP9-04 | KTH-2001 | | 33 |
| 250-900-1161P | | Plug, Crimp | M | Passivated | 1.187 _{max} | 0.219 | | | E | CAP9-04 | KTH-2001 | | 33 |
| 875-3-3 | M39012/55B3116 | Plug, Crimp | M | Passivated | 0.990 | 0.220 | 0.310 | | E1 | CP-432 | KTH-2001 | | 34 |
| 875-21-17 | M39012/55-3502 | Plug, Crimp | M | Passivated | 0.990 | 0.220 | 0.310 | | E2 | CP-432 | KTH-2113 | | 34 |
| 875-21-18 | M39012/55-4502 | Plug, Crimp | M | Passivated | 0.990 | 0.220 | 0.310 | | E1 | CP-493 | KTH-2113 | | 34 |
| 875-21-3 | M39012/55-3602 | Plug, Crimp | M | Passivated | 0.990 | 0.220 | 0.310 | | E2 | CP-432 | KTH-2113 | | 34 |
| 875-110-4 | | Plug, Crimp | M | Nickel | 1.210 | 0.210 | 0.400 | | 84 | 3-712 | KTH-2026 | | N/S |
| 875-57-1 | | Plug, Crimp | M | Gold | 0.990 | 0.120 | 0.310 | | B1 | CP-439 | KTH-2021 | | 34 |
| 875-9 M09 | | Plug, Crimp | M | Gold | 0.870 | 0.120 | 0.310 | | B1 | CP-439 | KTH-2021 | | 34 |
| 875-9-3 | M39012/55B3112 | Plug, Crimp | M | Passivated | 0.930 | 0.120 | 0.310 | | B1 | CP-439 | KTH-2021 | | 34 |
| 875-1-3 | M39012/55B3114 | Plug, Crimp | M | Passivated | 0.990 | 0.210 | 0.310 | | D | CP-432 | KTH-2001 | | 34 |



- 50 Ohm Nominal Impedance.
- Push/Pull connection system does not require special tooling for mating/unmating.
- When mated, connectors can rotate 360 degrees.
- Mate with standard SMA jacks with thread lengths of .200" +/- .005".
- Designs available for flexible and semi-rigid cables.
- Frequency Range: Up to 6 GHz

SPECIFICATIONS

MATERIAL

| | |
|------------------|---------------------------------------|
| Body: | Brass |
| Crimp Sleeves: | Copper Alloy |
| Center Contacts: | Brass (Male) Copper Alloy (Female) |
| Outer Contacts: | Copper Alloy |
| Insulators: | PTFE |

FINISHES

| | |
|------------------|----------------|
| Body: | Gold or Nickel |
| Center Contacts: | Gold |

ELECTRICAL

| | |
|------------------------|-----------------------|
| Impedance: | 50 Ohms |
| Frequency Range: | DC to 6 GHz |
| VSWR: | 1.25 Max |
| Return Loss: | -19.1 dB Minimum |
| Insulation Resistance: | 5,000 Megohms Minimum |

MECHANICAL

| | |
|----------------------|-------------------|
| Life: | 500 Cycles |
| Mating Force: | 10 Pounds Maximum |
| Unmating Force: | 10 Pounds Maximum |
| Connector Retention: | 30 Pounds Minimum |

ENVIRONMENTAL

| | |
|----------------------|--------------------------------------|
| Temperature Range: | -65° C to +165° C |
| Vibration: | MIL-STD-202, Method 204, Condition B |
| Shock: | MIL-STD-202, Method 213, Condition A |
| Thermal Shock: | MIL-STD-202, Method 107, Condition B |
| Corrosion: | MIL-STD-202, Method 101, Condition B |
| Moisture Resistance: | MIL-STD-202, Method 106 |

INTERFACE DIMENSIONS



CABLE PLUGS, SOLDER TYPE - SEMI-RIGID CABLE



FIGURE 1



FIGURE 2

CABLE PLUGS, CRIMP TYPE - FLEXIBLE CABLE

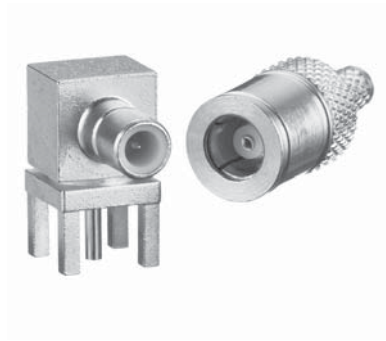

FIGURE 3



FIGURE 4

| Item Number | Military PN | Product Description | Gender | Finish | Dimensions | | | | Cable Group | Cable Procedure | Crimp Die | Mounting Hole | Figure # |
|---------------|-------------|---------------------|--------|--------|------------|---|---|---|-------------|-----------------|-----------|---------------|----------|
| | | | | | A | B | C | D | | | | | |
| 152-500-1410N | | Plug, Solder | M | Gold | 0.145 | | | | 49 | | | | 1 |
| 152-500-0850N | | Plug, Solder | M | Gold | 0.090 | | | | 50 | | | | 1 |
| 150-500-0850N | | Plug, Solder | M | Gold | 0.090 | | | | 50 | | | | 2 |
| 150-500-1410N | | Plug, Solder | M | Gold | 0.145 | | | | 49 | | | | 2 |
| 150-900-0631N | | Plug, Crimp | M | Nickel | 0.142 | | | | 3 | | KTH-2015 | | 3 |
| 150-900-0630N | | Plug, Crimp | M | Nickel | 0.128 | | | | B | | KTH-2011 | | 3 |
| 152-900-0631N | | Plug, Crimp | M | Nickel | 0.142 | | | | 3 | | KTH-2015 | | 4 |
| 152-900-0630N | | Plug, Crimp | M | Nickel | 0.128 | | | | B | | KTH-2011 | | 4 |



- Available in 50 Ohm and 75 Ohm versions.
- Snap-on interface reduces installation time.
- Self-cleaning outer spring withstands moderate vibration.
- Small & lightweight.
- Frequency Range: Up to 4 GHz

SPECIFICATIONS

MATERIAL

| | |
|----------------|---------------------------------------|
| Body: | Brass |
| Crimp Sleeves: | Annealed Copper Alloy |
| Contacts: | Brass (Male) Copper Alloy (Female) |
| Insulators: | PTFE |
| Lockwashers: | Phosphor Bronze |

FINISHES

| | |
|------------------|----------------|
| Body: | Gold or Nickel |
| Center Contacts: | Gold |

MECHANICAL

| | |
|----------------------|---------------------------------------|
| Life: | 500 Cycles |
| Engagement Force: | 14 Pounds Maximum |
| Disengagement Force: | 2 Pounds Minimum 14 Pounds Maximum |

ELECTRICAL

| | |
|-------------------|---|
| Impedance: | 50 Ohms |
| Frequency Range: | DC to 4 GHz |
| VSWR: | |
| RG196 or similar | Straight: 1.30 + .04F Right Angle: 1.45 + .06F |
| RG 316 or similar | Straight: 1.25 + .04F Right Angle: 1.35 + .04F |
| Insertion Loss: | .25 dB Max at 4 GHz |

ENVIRONMENTAL

| | |
|----------------------|--------------------------------------|
| Temperature Range: | -65° C to +165° C |
| Vibration: | MIL-STD-202, Method 204, Condition B |
| Shock: | MIL-STD-202, Method 213, Condition B |
| Corrosion: | MIL-STD-202, Method 101, Condition B |
| Temperature Cycling: | MIL-STD-202, Method 102, Condition C |

INTERFACE DIMENSIONS

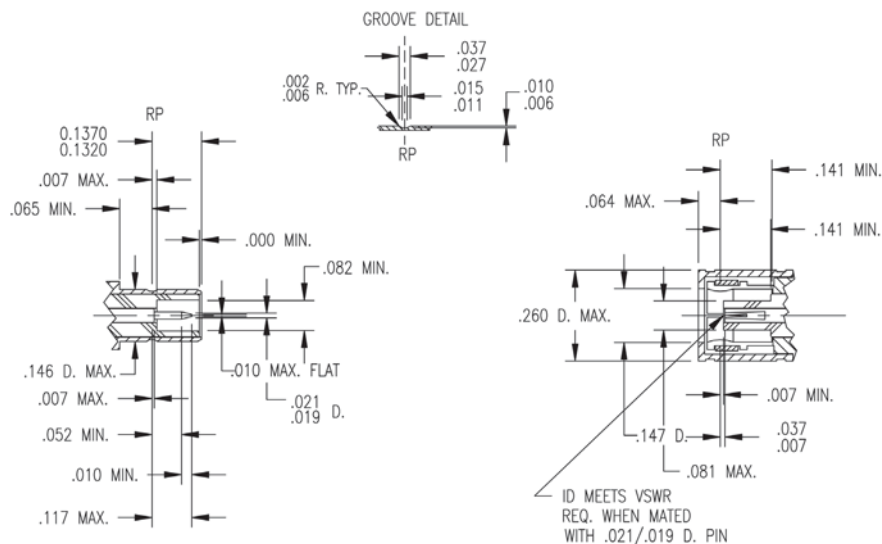

CABLE PLUGS, CRIMP TYPE - FLEXIBLE CABLE



FIGURE 1

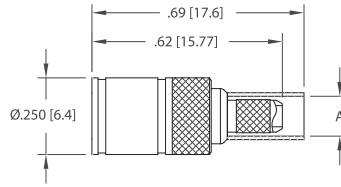

FIGURE 2



FIGURE 3

CABLE JACKS, CRIMP TYPE - FLEXIBLE CABLE



FIGURE 4



FIGURE 5

| Item Number | Military PN | Product Description | Gender | Finish | Dimensions | | | | Cable Group | Cable Procedure | Crimp Die | Mounting Hole | Figure # |
|---------------|-------------|---------------------------|--------|--------|------------|---|---|-------|-------------|-----------------|-----------|---------------|----------|
| | | | | | A | B | C | T | | | | | |
| 510-800-0631H | | Plug, Crimp/Clamp | F | Gold | 0.142 | | | | 3 | CAP8-02 | KTH-2015 | | 1 |
| 510-800-0631N | | Plug, Crimp/Clamp | F | Nickel | 0.142 | | | | 3 | CAP8-02 | KTH-2015 | | 1 |
| 510-800-0360H | | Plug, Crimp/Clamp | F | Gold | 0.091 | | | | A | CAP8-02 | KTH-2008 | | 1 |
| 510-800-0360N | | Plug, Crimp/Clamp | F | Nickel | 0.091 | | | | A | CAP8-02 | KTH-2008 | | 1 |
| 510-800-0630H | | Plug, Crimp/Clamp | F | Gold | 0.128 | | | | B | CAP8-02 | KTH-2011 | | 1 |
| 510-800-0630N | | Plug, Crimp | F | Nickel | 0.128 | | | | B | CAP8-02 | KTH-2011 | | 1 |
| 510-900-0360H | | Plug, Crimp | F | Gold | 0.091 | | | | A | CAP9-08 | KTH-2008 | | 2 |
| 510-900-0360N | | Plug, Crimp | F | Nickel | 0.091 | | | | A | CAP9-08 | KTH-2008 | | 2 |
| 510-900-0630H | | Plug, Crimp | F | Gold | 0.128 | | | | B | CAP9-08 | KTH-2011 | | 2 |
| 510-900-0630N | | Plug, Crimp | F | Nickel | 0.128 | | | | B | CAP9-08 | KTH-2011 | | 2 |
| 512-900-0631H | | Plug, Angle, Crimp | F | Gold | 0.142 | | | | 3 | CAP9-06 | KTH-2015 | | 3 |
| 512-900-0631N | | Plug, Angle, Crimp | F | Nickel | 0.142 | | | | 3 | CAP9-06 | KTH-2015 | | 3 |
| 512-900-0360H | | Plug, Angle, Crimp | F | Gold | 0.091 | | | | A | CAP9-06 | KTH-2008 | | 3 |
| 512-900-0360N | | Plug, Angle, Crimp | F | Nickel | 0.091 | | | | A | CAP9-06 | KTH-2008 | | 3 |
| 512-900-0630H | | Plug, Angle, Crimp | F | Gold | 0.128 | | | | B | CAP9-06 | KTH-2011 | | 3 |
| 512-900-0630N | | Plug, Angle, Crimp | F | Nickel | 0.128 | | | | B | CAP9-06 | KTH-2011 | | 3 |
| 511-880-0631H | | Jack, Bulkhd, Crimp/Clamp | M | Gold | 0.142 | | | 0.093 | 3 | CAP8-02 | KTH-2015 | P | 4 |
| 511-880-0631N | | Jack, Bulkhd | M | Nickel | 0.142 | | | 0.093 | 3 | CAP8-02 | KTH-2015 | P | 4 |
| 511-880-0360H | | Jack, Bulkhd, Crimp/Clamp | M | Gold | 0.091 | | | 0.093 | A | CAP8-02 | KTH-2008 | P | 4 |
| 511-880-0360N | | Jack, Bulkhd, Crimp/Clamp | M | Nickel | 0.091 | | | 0.093 | A | CAP8-02 | KTH-2008 | P | 4 |
| 511-880-0630H | | Jack, Bulkhd, Crimp/Clamp | M | Gold | 0.128 | | | 0.093 | B | CAP8-02 | KTH-2011 | P | 4 |
| 511-880-0630N | | Jack, Bulkhd, Crimp/Clamp | M | Nickel | 0.128 | | | 0.093 | B | CAP8-02 | KTH-2011 | P | 4 |
| 511-980-0631H | | Jack, Bulkhd, Crimp | M | Gold | 0.142 | | | 0.093 | 3 | CAP9-08 | KTH-2015 | P | 5 |
| 511-980-0631N | | Jack, Bulkhd, Crimp | M | Nickel | 0.142 | | | 0.093 | 3 | CAP9-08 | KTH-2015 | P | 5 |
| 511-980-0360H | | Jack, Bulkhd, Crimp | M | Gold | 0.091 | | | 0.093 | A | CAP9-08 | KTH-2008 | P | 5 |
| 511-980-0360N | | Jack, Bulkhd, Crimp | M | Nickel | 0.091 | | | 0.093 | A | CAP9-08 | KTH-2008 | P | 5 |
| 511-980-0630H | | Jack, Bulkhd, Crimp | M | Gold | 0.128 | | | 0.093 | B | CAP9-08 | KTH-2011 | P | 5 |
| 511-980-0630N | | Jack, Bulkhd, Crimp | M | Nickel | 0.128 | | | 0.093 | B | CAP9-08 | KTH-2011 | P | 5 |

CABLE PLUGS, SOLDER TYPE - SEMI-RIGID CABLE

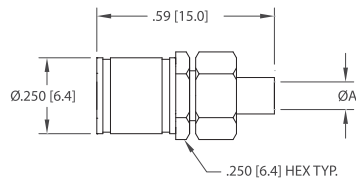

FIGURE 6

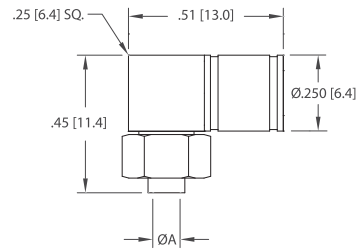

FIGURE 7

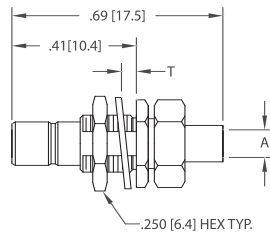

FIGURE 8

| Item Number | Military PN | Product Description | Gender | Finish | Dimensions | | | | Cable Group | Cable Procedure | Crimp Die | Mounting Hole | Figure # |
|---------------|-------------|----------------------------|--------|--------|------------|---|---|-------|-------------|-----------------|-----------|---------------|----------|
| | | | | | A | B | C | T | | | | | |
| 510-600-0850N | | Plug, Solder/Clamp | F | Nickel | 0.090 | | | | 48 | CAP6-01 | | | 6 |
| 510-600-1410H | | Plug, Solder/Clamp | F | Gold | 0.144 | | | | 49 | CAP6-01 | | | 6 |
| 510-600-1410N | | Plug, Solder/Clamp | F | Nickel | 0.144 | | | | 49 | CAP6-01 | | | 6 |
| 510-600-0850H | | Plug, Solder/Clamp | F | Gold | 0.090 | | | | 48 | CAP6-01 | | | 6 |
| 512-600-0850H | | Plug, Angle, Solder/Clamp | F | Gold | 0.090 | | | | 48 | CAP6-02 | | | 7 |
| 512-600-0850N | | Plug, Angle, Solder/Clamp | F | Nickel | 0.090 | | | | 48 | CAP6-02 | | | 7 |
| 512-600-1410H | | Plug, Angle, Solder/Clamp | F | Gold | 0.144 | | | | 49 | CAP6-02 | | | 7 |
| 512-600-1410N | | Plug, Angle, Solder/Clamp | F | Nickel | 0.144 | | | | 49 | CAP6-02 | | | 7 |
| 511-680-0850H | | Jack, Bulkhd, Solder/Clamp | M | Gold | 0.090 | | | 0.093 | 48 | CAP6-01 | | P | 8 |
| 511-680-1410H | | Jack, Bulkhd, Solder/Clamp | M | Gold | 0.144 | | | 0.093 | B | CAP6-01 | | P | 8 |

PCB JACK



FIGURE 9



FIGURE 10

PCB JACK

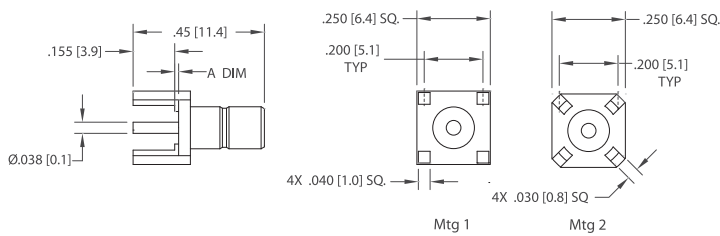

FIGURE 11

PCB PLUG

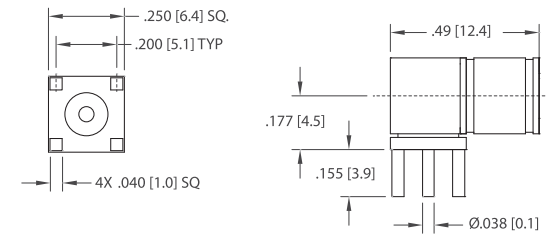

FIGURE 13



FIGURE 12



FIGURE 14

SURFACE MOUNT PLUG

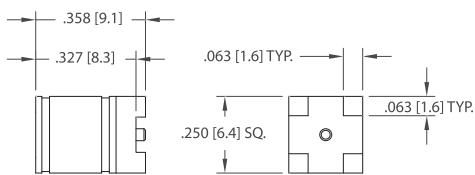

FIGURE 15

SURFACE MOUNT JACK

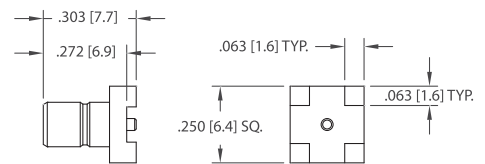

FIGURE 16

CABLE JACKS, SOLDER TYPE



FIGURE 17

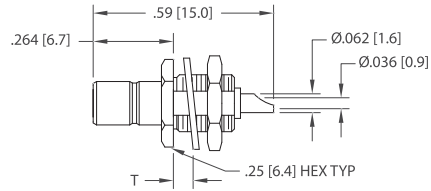

FIGURE 18

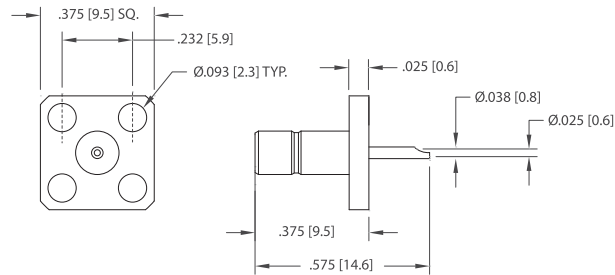
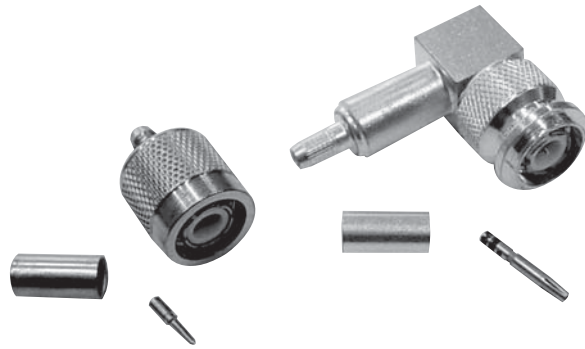

FIGURE 19

| Item Number | Military PN | Product Description | Gender | Finish | Dimensions | | | | Cable Group | Cable Procedure | Crimp Die | Mounting Hole | Figure # |
|---------------|-------------|------------------------------|--------|--------|------------|-------|---|-------|-------------|-----------------|-----------|---------------|----------|
| | | | | | A | B | C | T | | | | | |
| 513-060-0040H | | Jack, Angle, PCB | M | Gold | | | | | | | U | 9 | |
| 513-060-0040N | | Jack, Angle, PCB | M | Nickel | | | | | | | U | 9 | |
| 513-060-0080H | | Jack, Angle, Bulkhd, PCB | M | Gold | | | | 0.093 | | | U & P | 10 | |
| 513-060-0080N | | Jack, Angle, Bulkhd, PCB | M | Nickel | | | | 0.093 | | | U & P | 10 | |
| 511-060-0040H | | Jack, PCB | M | Gold | 0.000 | | | | | | U | 11_1 | |
| 511-060-0040N | | Jack, PCB | M | Nickel | 0.000 | | | | | | U | 11_1 | |
| 511-060-0047H | | Jack, PCB | M | Gold | 0.000 | | | | | | 0 | 11_2 | |
| 511-060-0048H | | Jack, PCB | M | Gold | 0.020 | | | | | | 0 | 11_2 | |
| 511-060-0047N | | Jack, PCB | M | Nickel | 0.000 | | | | | | 0 | 11_2 | |
| 511-060-0048N | | Jack, PCB | M | Nickel | 0.020 | | | | | | 0 | 11_2 | |
| 513-077-0040H | | Jack, Angle, PCB, Surface Mt | M | Gold | | | | | | | | 12 | |
| 512-060-0040H | | Plug, Angle, PCB | F | Gold | | | | | | | U | 13 | |
| 512-060-0040N | | Plug, Angle, PCB | F | Nickel | | | | | | | U | 13 | |
| 510-060-0040H | | Plug, PCB | F | Gold | 0.000 | 0.470 | | | | | U | 14 | |
| 510-060-0047H | | Plug, PCB | F | Gold | 0.020 | 0.490 | | | | | U | 14 | |
| 510-060-0040N | | Plug, PCB | F | Nickel | 0.000 | 0.470 | | | | | U | 14 | |
| 510-060-0047N | | Plug, PCB | F | Nickel | 0.020 | 0.490 | | | | | U | 14 | |
| 510-077-0040H | | Plug, PCB, Surface Mt | F | Gold | | | | | | | | 15 | |
| 511-077-0040H | | Jack, PCB, Surface Mt | M | Gold | | | | | | | | 16 | |
| 511-080-0000H | | Receptacle, Bulkhd | M | Gold | | | | 0.093 | | | P | 17 | |
| 511-080-0001H | | Receptacle, Bulkhd | M | Gold | | | | 0.093 | | | P | 17 | |
| 511-080-0000N | | Receptacle, Bulkhd | M | Nickel | | | | 0.093 | | | P | 17 | |
| 511-080-0001N | | Receptacle, Bulkhd | M | Nickel | | | | 0.093 | | | P | 17 | |
| 511-082-0000H | | Receptacle, Bulkhd | M | Gold | | | | 0.093 | | | P | 18 | |
| 511-082-0000N | | Receptacle, Bulkhd | M | Nickel | | | | 0.093 | | | P | 18 | |
| 511-071-0000H | | Receptacle, Panel | M | Gold | | | | | | | V | 19 | |
| 511-071-0000N | | Receptacle, Panel | M | Nickel | | | | | | | V | 19 | |



- 50 Ohm & 75 Ohm versions available.
- Miniature size connector with threaded coupling.
- Withstands shock & vibration, ideal for harsh environments.
- Keyed versions available to prevent mismatching and misalignment in critical applications.
- Commercial and Military-Specified versions available.
- Frequency Range: Up to 11 GHz

SPECIFICATIONS

MATERIAL

| | |
|------------------|---|
| Body: | Brass |
| Crimp Sleeves: | Commercial Bronze Alloy |
| Center Contacts: | Brass (Male) Beryllium Copper (Female) |
| Outer Contacts: | Beryllium Copper (Male) |
| Insulators: | PTFE |
| Gaskets & Seals: | Silicone Rubber |

FINISHES

| | |
|------------------|------------------|
| Body: | Silver or Nickel |
| Center Contacts: | Gold |

ELECTRICAL

| | |
|------------------|------------------------|
| Impedance: | 50 Ohms or 75 Ohms |
| Frequency Range: | DC to 11 GHz |
| Voltage Rating: | 500 Volts RMS |
| VSWR: | 1.30 Max, DC to 11 GHz |
| Insertion Loss: | .18 dB Max at 9 GHz |

MECHANICAL

| | |
|------------------|-------------------|
| Life: | 500 Cycles |
| Cable Retention: | 40 Pounds Minimum |

ENVIRONMENTAL

| | |
|----------------------|--------------------------------------|
| Temperature Range: | -65° C to +165° C |
| Vibration: | MIL-STD-202, Method 204, Condition B |
| Shock: | MIL-STD-202, Method 213, Condition I |
| Corrosion: | MIL-STD-202, Method 101, Condition B |
| Moisture Resistance: | MIL-STD-202, Method 106 |

INTERFACE DIMENSIONS

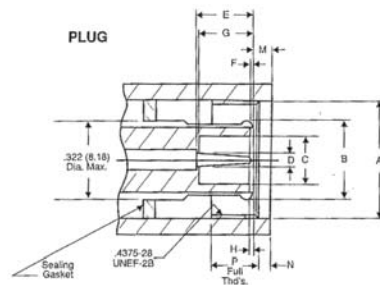

| Dim Ltr | Inches (mm) | | Dim Ltr | Inches (mm) | |
|---------|--------------|-------------|---------|-------------|-------------|
| | Minimum | Maximum | | Minimum | Maximum |
| A | .440 (11.18) | | G | .208 (5.28) | .228 (5.79) |
| B | Gauge Test | | H | .003 (0.08) | .040 (1.02) |
| C | .190 (4.83) | | M | | .078 (1.98) |
| D | .052 (1.32) | .054 (1.37) | N | .063 (1.60) | |
| E | .210 (5.33) | .230 (5.84) | P | .156 (3.96) | |
| F | .006 (0.15) | | | | |

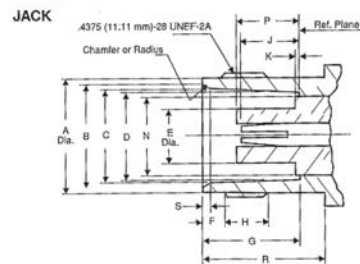

| Dim Ltr | Inches (mm) | | Dim Ltr | Inches (mm) | |
|---------|-------------|-------------|---------|--------------|-------------|
| | Minimum | Maximum | | Minimum | Maximum |
| A | .378 (9.60) | .381 (9.68) | H | .187 (4.75) | |
| B | .346 (8.79) | .356 (9.04) | J | .186 (4.72) | .206 (5.23) |
| C | .327 (8.31) | .333 (8.46) | K | | .006 (0.15) |
| D | .319 (8.10) | .321 (8.15) | N | | .256 (6.50) |
| E | | .186 (4.72) | P | .188 (4.78) | .208 (5.28) |
| F | .068 (1.73) | .088 (2.24) | R | .414 (10.52) | |
| G | .327 (8.31) | .335 (8.51) | S | .015 (0.38) | .030 (0.76) |

JACK - CONVENTIONAL



FIGURE 1

PANEL JACK - CONVENTIONAL



FIGURE 2

JACKS - K-GRIP, JR.

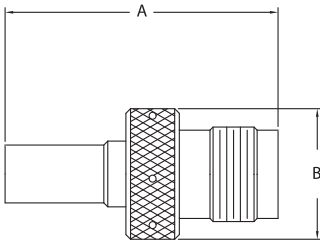

FIGURE 3

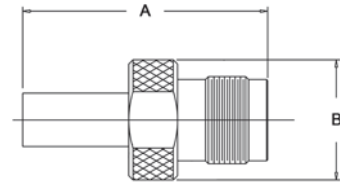

FIGURE 4

| Item Number | Military PN | Product Description | Gender | Finish | Dimensions | | | | Cable Group | Cable Procedure | Crimp Die | Mounting Hole | Figure # |
|---------------|----------------|----------------------------------|--------|--------|------------|-------|-------|-------|-------------|-----------------|-----------|---------------|----------|
| | | | | | A | B | C | D | | | | | |
| KA-39-87 | M39012/27-0101 | Jack, Conventional | F | Silver | 1.150 | 0.560 | | | DE | CP-1050 | | | 1 |
| 121-25-5 | | Jack, Conventional, Panel | F | Silver | 1.250 | 0.560 | 0.090 | 0.500 | 3 | CP-1050 | | * | 2 |
| KA-19-181 | M39012/29-0018 | Jack, Conventional, Panel | F | Silver | 1.150 | 0.550 | 0.090 | 0.500 | B1 | CP-1050 | | * | 2 |
| KA-19-176 | M39012/29-0101 | Jack, Conventional, Panel | F | Silver | 1.150 | 0.550 | 0.090 | 0.500 | DE | CP-1050 | | * | 2 |
| 2431-78-10 | | Jack, Conventional, Panel, Keyed | F | | 1.160 | 1.000 | 0.090 | 0.210 | | 3-355 | | | N/S |
| 2431-78-5 | | Jack, Conventional, Panel, Keyed | F | | 1.160 | 1.000 | 0.090 | 0.210 | | 3-355 | | | N/S |
| 123-22-5 | | Jack, Crimp, Weatherproof | F | Silver | 1.170 | 0.580 | | | 16 | 3-546-1 | KTH-2121 | | 3 |
| 123-23-9 | | Jack, Crimp, Weatherproof | F | Nickel | 1.720 | 0.590 | | | 18 | 3-546-2 | KTH-2212 | | 3 |
| 123-27-9 | | Jack, Crimp, Weatherproof | F | Nickel | 1.800 | 0.730 | | | 20 | 3-546-2 | KTH-2229 | | 3 |
| KA-39-82 | | Jack, Crimp, Weatherproof | F | Nickel | 1.200 | 0.580 | | | D | CP-5401 | KTH-2061 | | 3 |
| KA-39-85 | | Jack, Crimp, Weatherproof | F | Nickel | 1.200 | 0.560 | | | E1 | CP-5401 | KTH-2061 | | 3 |
| KA-39-100 M06 | | Jack, Crimp, Weatherproof | F | Nickel | 1.810 | 0.500 | | | N3 | CP-5402 | KTH-2105 | | 3 |
| KA-39-79 | M39012/27-0503 | Jack, Crimp | F | Silver | 1.180 | 0.580 | | | E1 | CP-465 | KTH-2001 | | 4 |
| KA-39-76 | M39012/27-0504 | Jack, Crimp | F | Silver | 1.170 | 0.560 | | | D | CP-465 | KTH-2001 | | 4 |

*Please Contact Customer Service for Additional Information

BULKHEAD JACK - CONVENTIONAL

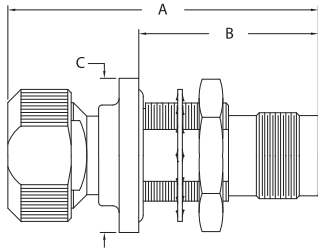

FIGURE 5

ANGLE JACK - K-GRIP, JR.

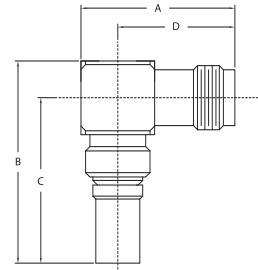

FIGURE 6

BULKHEAD JACKS - K-GRIP, JR.

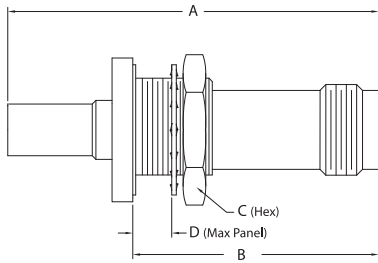

FIGURE 7

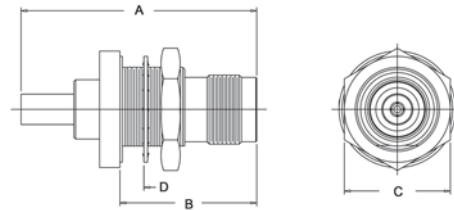

FIGURE 8

| Item Number | Military PN | Product Description | Gender | Finish | Dimensions | | | | Cable Group | Cable Procedure | Crimp Die | Mounting Hole | Figure # |
|-------------|----------------|----------------------------------|--------|--------|------------|-------|-------|-------|-------------|-----------------|-----------|---------------|----------|
| | | | | | A | B | C | D | | | | | |
| KA-11-07 | | Jack, Conventional, Bulkhd | F | | 1.580 | 0.220 | | | | CP-1006 | | X | 5 |
| KA-19-142 | | Jack, Conventional, Bulkhd | F | Nickel | 1.470 | 0.860 | 0.730 | | B1 | CP-1004.1 | | | 5 |
| 122-32-5 | M39012/28-0018 | Jack, Conventional, Bulkhd | F | Silver | 1.250 | 0.810 | 0.690 | | B1 | 3-527 | | X | 5 |
| 122-50-5 | | Jack, Conventional, Bulkhd | F | Silver | 1.250 | 0.810 | 0.690 | | B1 | 3-527 | | X | 5 |
| KA-19-171 | M39012/28-0018 | Jack, Conventional, Bulkhd | F | Silver | 1.150 | 0.810 | 0.690 | | B1 | CP-1050 | | X | 5 |
| KA-19-19 | M39012/28-0101 | Jack, Conventional, Bulkhd | F | Silver | 1.150 | 0.810 | 0.690 | | D | CP-1004 | | X | 5 |
| 122-27-5 | M39012/28-0101 | Jack, Conventional, Bulkhd | F | Silver | 1.250 | 0.810 | 0.690 | | E1 | 3-526 | | X | 5 |
| KA-19-172 | M39012/28-0102 | Jack, Conventional, Bulkhd | F | Silver | 1.160 | 0.690 | 0.260 | | G | CP-1050 | | X | 5 |
| 123-24-9 | | Jack, Crimp, Angle, Weatherproof | F | Nickel | 1.050 | 1.370 | 1.100 | 0.800 | 17 | 3-546-1 | KTH-2216 | | 6 |
| 123-28-9 | | Jack, Crimp, Angle, Weatherproof | F | Nickel | 1.050 | 1.930 | 1.680 | 0.800 | 20 | 3-546-2 | KTH-2229 | | 6 |
| 122-37-9 | | Jack, Crimp, Bulkhd | F | Nickel | 1.780 | 1.180 | 0.690 | | 16 | 3-546-1 | KTH-2161 | X | 7 |
| 122-3-5 | M39012/28-0022 | Jack, Crimp, Bulkhd | F | Silver | 1.620 | 0.810 | 0.690 | | B1 | CP-465 | KTH-2011 | X | 7 |
| 122-55-9 | | Jack, Crimp, Bulkhd | F | Nickel | 1.490 | 0.810 | 0.630 | 0.242 | B1 | 3-646 | KTH-2021 | X | 8 |
| KA-19-42 | | Jack, Crimp, Bulkhd | F | Silver | 1.390 | 0.800 | 0.630 | 0.242 | B1 | CP-407 | KTH-2032 | X | 8 |
| KA-19-60 | | Jack, Crimp, Bulkhd | F | Nickel | 1.390 | 0.800 | 0.630 | 0.242 | B1 | CP-407 | KTH-2032 | X | 8 |
| KA-19-151 | M39012/28-0502 | Jack, Crimp, Bulkhd | F | Silver | 1.400 | 0.810 | 0.630 | 0.241 | C2 | CP-465 | KTH-2007 | X | 8 |
| KA-19-101 | M39012/28-0010 | Jack, Crimp, Bulkhd | F | Silver | 1.550 | 0.810 | 0.630 | 0.241 | D | CP-465 | KTH-2001 | X | 8 |
| KA-19-153 | M39012/28-0504 | Jack, Crimp, Bulkhd | F | Silver | 1.400 | 0.810 | 0.630 | 0.241 | D | CP-465 | KTH-2001 | X | 8 |
| KA-19-102 | M39012/28-0011 | Jack, Crimp, Bulkhd | F | Silver | 1.550 | 0.810 | 0.630 | 0.241 | E1 | CP-465 | KTH-2001 | X | 8 |
| KA-19-152 | M39012/28-0503 | Jack, Crimp, Bulkhd | F | Silver | 1.400 | 0.810 | 0.630 | 0.241 | E1 | CP-465 | KTH-2001 | X | 8 |
| KA-19-146 | M39012/28-0021 | Jack, Crimp, Bulkhd | F | Silver | 1.550 | 0.810 | 0.630 | 0.241 | H | CP-465 | KTH-2002 | X | 8 |

ANGLE PANEL JACK - K-GRIP, JR.

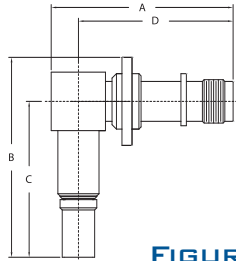

FIGURE 9

PANEL JACK - K-GRIP

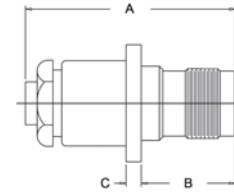

FIGURE 10

PANEL JACKS - K-GRIP, JR.

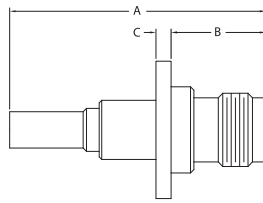

FIGURE 11

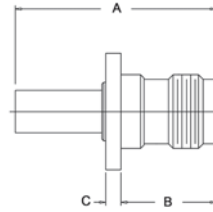

FIGURE 12

| Item Number | Military PN | Product Description | Gender | Finish | Dimensions | | | | Cable Group | Cable Procedure | Crimp Die | Mounting Hole | Figure # |
|---------------|----------------|---|--------|--------|------------|-------|-------|-------|-------------|-----------------|-----------|---------------|----------|
| | | | | | A | B | C | D | | | | | |
| 2430-2-16 | | Jack, Crimp, Angle, Panel, Weatherproof | F | Nickel | 1.670 | 1.840 | 1.430 | 1.420 | 17 | 3-546-2 | KTH-2216 | * | 9 |
| KA-19-25 | | Jack, Crimp, Panel | F | Silver | 1.240 | 0.640 | 0.090 | | D | CP-201A | KTH-2001 | * | 10 |
| KA-19-51 | | Jack, Crimp, Panel | F | Silver | 1.240 | 0.640 | 0.090 | | D | CP-201A | KTH-2001 | * | 10 |
| KA-39-93 M07 | | Jack, Crimp, Panel, Tee | F | Silver | 2.080 | 0.720 | 1.800 | | | 3-86 | KTH-2024 | | N/S |
| 121-11-9 | | Jack, Crimp, Panel | F | Nickel | 1.330 | 0.560 | 0.080 | | A | CP-1901 | KTH-2008 | * | N/S |
| 611-1-9 | | 75 Ohm, Jack, Crimp, Panel, W/P | F | Nickel | 1.590 | 0.651 | 0.089 | | B2 | 3-661-4 | KTH-2277 | * | 11 |
| KA-19-195 M06 | | Jack, Crimp, Panel, W/P | F | Nickel | 1.810 | 0.560 | 0.090 | | 2 | CP-480 | KTH-1079 | * | 11 |
| 121-35-9 | | Jack, Crimp, Panel, W/P | F | Nickel | 1.520 | 0.560 | 0.090 | | 15 | 3-546-1 | KTH-2214 | * | 11 |
| 121-36-9 | | Jack, Crimp, Panel, W/P | F | Nickel | 1.400 | 0.560 | 0.090 | | 16 | 3-546-1 | KTH-2161 | * | 11 |
| 121-44-9 | | Jack, Crimp, Panel, W/P | F | Nickel | 1.400 | 0.560 | 0.090 | | 16 | 3-546-1 | KTH-2161 | * | 11 |
| 2431-84-6 | | Jack, Crimp, Panel, W/P, Keyed | F | Nickel | 1.520 | 0.930 | 0.090 | | 16 | 3-546-1 | KTH-2161 | * | 11 |
| 121-39-7 | | Jack, Crimp, Panel, W/P | F | Nickel | 1.430 | 0.560 | 0.090 | | 17 | 3-546-1 | KTH-2216 | * | 11 |
| 121-39-9 | | Jack, Crimp, Panel, W/P | F | Nickel | 1.430 | 0.560 | 0.090 | | 17 | 3-546-1 | KTH-2216 | * | 11 |
| 121-46-9 | | Jack, Crimp, Panel, W/P | F | Nickel | 1.430 | 0.560 | 0.090 | | 17 | 3-546-1 | KTH-2216 | * | 11 |
| 121-38-9 | | Jack, Crimp, Panel, W/P | F | Nickel | 1.800 | 0.560 | 0.090 | | 19 | 3-546-2 | KTH-2213 | * | 11 |
| KA-19-143 | | Jack, Crimp, Panel, W/P | F | Nickel | 1.440 | 0.560 | 0.090 | | D | CP-5401 | KTH-2061 | * | 11 |
| KA-19-216 M06 | | Jack, Crimp, Panel, W/P | F | Nickel | 1.180 | 0.560 | 0.090 | | E1 | CP-5401 | KTH-2061 | * | 11 |
| KA-19-213 M06 | | Jack, Crimp, Panel, W/P | F | Nickel | 1.810 | 0.560 | 0.090 | | N3 | CP-5402 | KTH-2105 | * | 11 |
| KA-19-198 M06 | | Jack, Crimp, Panel, W/P | F | Nickel | 1.440 | 0.560 | 0.090 | | | CP-5401 | KTH-2128 | * | 11 |
| KA-19-83 | | Jack, Crimp, Panel, W/P | F | Nickel | 1.410 | 0.560 | 0.090 | | 45 | CP-5041 | KTH-2161 | * | 11 |
| 121-52-9 | | Jack, Crimp, Panel, Iso Grnd, W/P | F | Nickel | 1.520 | 0.790 | 0.090 | | 15 | 3-546-1 | KTH-2214 | * | 11 |
| 121-40-9 | | Jack, Crimp, Panel, Iso Grnd, W/P | F | Nickel | 1.410 | 0.790 | 0.090 | | 16 | 3-546-1 | KTH-2161 | * | 11 |
| 121-37-9 | | Jack, Crimp, Panel, W/P | F | Nickel | 1.710 | 0.560 | 0.090 | | 18 | 3-546-2 | KTH-2212 | * | 12 |
| 121-45-9 | | Jack, Crimp, Panel, W/P | F | Nickel | 1.710 | 0.560 | 0.090 | | 18 | 3-546-2 | KTH-2212 | * | 12 |
| KA-19-214 | M39012/29-0022 | Jack, Crimp, Panel | F | Silver | 1.310 | 0.560 | 0.090 | | B1 | CP-465 | KTH-2011 | * | 12 |
| KA-19-155 | M39012/29-0502 | Jack, Crimp, Panel | F | Silver | 1.180 | 0.560 | 0.090 | | C2 | CP-465 | KTH-2007 | * | 12 |
| KA-19-157 | M39012/29-0504 | Jack, Crimp, Panel | F | Silver | 1.180 | 0.560 | 0.090 | | D | CP-465 | KTH-2001 | * | 12 |
| KA-19-156 | M39012/29-0503 | Jack, Crimp, Panel | F | Silver | 1.180 | 0.560 | 0.090 | | E1 | CP-465 | KTH-2001 | * | 12 |
| KA-19-110 | M39012/29-0014 | Jack, Crimp, Panel | F | Silver | 1.410 | 0.260 | | | G2 | CP-465 | KTH-2002 | * | 12 |

*Please Contact Customer Service for Additional Information

KEYED PANEL JACK - K-GRIP, JR.

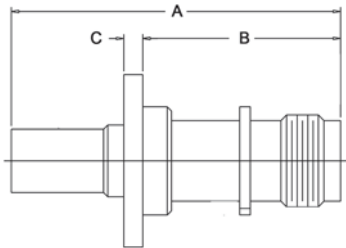

FIGURE 13

| Item Number | Military PN | Product Description | Gender | Finish | Dimensions | | | | Cable Group | Cable Procedure | Crimp Die | Mounting Hole | Figure # |
|-------------|-------------|--------------------------------|--------|--------|------------|-------|-------|---|-------------|-----------------|-----------|---------------|----------|
| | | | | | A | B | C | D | | | | | |
| 2431-76-1 | | Jack, Crimp, Panel, W/P, Keyed | F | Nickel | 2.030 | 0.930 | 0.090 | | 2 | CP-5402 | KTH-1079 | * | 13 |
| 2431-76-11 | | Jack, Crimp, Panel, W/P, Keyed | F | Nickel | 2.030 | 0.930 | 0.090 | | 2 | CP-5402 | KTH-1079 | * | 13 |
| 2431-76-16 | | Jack, Crimp, Panel, W/P, Keyed | F | Nickel | 2.030 | 0.930 | 0.090 | | 2 | CP-5402 | KTH-1079 | * | 13 |
| 2431-76-6 | | Jack, Crimp, Panel, W/P, Keyed | F | Nickel | 2.030 | 0.930 | 0.090 | | 2 | CP-5402 | KTH-1079 | * | 13 |
| 2431-81-1 | | Jack, Crimp, Panel, W/P, Keyed | F | Nickel | 1.550 | 0.930 | 0.090 | | 15 | 3-546-1 | KTH-2214 | * | 13 |
| 2431-81-11 | | Jack, Crimp, Panel, W/P, Keyed | F | Nickel | 1.550 | 0.930 | 0.090 | | 15 | 3-546-1 | KTH-2214 | * | 13 |
| 2431-81-16 | | Jack, Crimp, Panel, W/P, Keyed | F | Nickel | 1.550 | 0.930 | 0.090 | | 15 | 3-546-1 | KTH-2214 | * | 13 |
| 2431-81-2 | | Jack, Crimp, Panel, W/P, Keyed | F | Nickel | 1.550 | 0.930 | 0.090 | | 15 | 3-546-1 | KTH-2214 | * | 13 |
| 2431-81-6 | | Jack, Crimp, Panel, W/P, Keyed | F | Nickel | 1.550 | 0.930 | 0.090 | | 15 | 3-546-1 | KTH-2214 | * | 13 |
| 2431-81-9 | | Jack, Crimp, Panel, W/P, Keyed | F | Nickel | 1.550 | 0.930 | 0.090 | | 15 | 3-546-1 | KTH-2214 | * | 13 |
| 2431-80-1 | | Jack, Crimp, Panel, W/P, Keyed | F | Nickel | 1.520 | 0.930 | 0.090 | | 16 | 3-546-1 | KTH-2161 | * | 13 |
| 2431-80-11 | | Jack, Crimp, Panel, W/P, Keyed | F | Nickel | 1.520 | 0.930 | 0.090 | | 16 | 3-546-1 | KTH-2161 | * | 13 |
| 2431-80-16 | | Jack, Crimp, Panel, W/P, Keyed | F | Nickel | 1.520 | 0.930 | 0.090 | | 16 | 3-546-1 | KTH-2161 | * | 13 |
| 2431-80-20 | | Jack, Crimp, Panel, W/P, Keyed | F | Nickel | 1.520 | 0.930 | 0.090 | | 16 | 3-546-1 | KTH-2161 | * | 13 |
| 2431-80-6 | | Jack, Crimp, Panel, W/P, Keyed | F | Nickel | 1.520 | 0.930 | 0.090 | | 16 | 3-546-1 | KTH-2161 | * | 13 |
| 2431-84-1 | | Jack, Crimp, Panel, W/P, Keyed | F | Nickel | 1.520 | 0.930 | 0.090 | | 16 | 3-546-1 | KTH-2161 | * | 13 |
| 2431-84-11 | | Jack, Crimp, Panel, W/P, Keyed | F | Nickel | 1.520 | 0.930 | 0.090 | | 16 | 3-546-1 | KTH-2161 | * | 13 |
| 2431-84-16 | | Jack, Crimp, Panel, W/P, Keyed | F | Nickel | 1.520 | 0.930 | 0.090 | | 16 | 3-546-1 | KTH-2161 | * | 13 |
| 2431-84-2 | | Jack, Crimp, Panel, W/P, Keyed | F | Nickel | 1.520 | 0.930 | 0.090 | | 16 | 3-546-1 | KTH-2161 | * | 13 |
| 2431-84-5 | | Jack, Crimp, Panel, W/P, Keyed | F | Nickel | 1.520 | 0.930 | 0.090 | | 16 | 3-546-1 | KTH-2161 | * | 13 |
| 2431-85-1 | | Jack, Crimp, Panel, W/P, Keyed | F | Nickel | 1.550 | 0.930 | 0.090 | | 17 | 3-546-1 | KTH-2216 | * | 13 |
| 2431-85-11 | | Jack, Crimp, Panel, W/P, Keyed | F | Nickel | 1.550 | 0.930 | 0.090 | | 17 | 3-546-1 | KTH-2216 | * | 13 |
| 2431-85-16 | | Jack, Crimp, Panel, W/P, Keyed | F | Nickel | 1.550 | 0.930 | 0.090 | | 17 | 3-546-1 | KTH-2216 | * | 13 |
| 2431-85-6 | | Jack, Crimp, Panel, W/P, Keyed | F | Nickel | 1.550 | 0.930 | 0.090 | | 17 | 3-546-1 | KTH-2216 | * | 13 |
| 2431-87-1 | | Jack, Crimp, Panel, W/P, Keyed | F | Nickel | 1.550 | 0.930 | 0.090 | | 17 | 3-546-1 | KTH-2216 | * | 13 |

*Please Contact Customer Service for Additional Information

| Item Number | Military PN | Product Description | Gender | Finish | Dimensions | | | | Cable Group | Cable Procedure | Crimp Die | Mounting Hole | Figure # |
|-------------|-------------|--|--------|--------|------------|-------|-------|---|-------------|-----------------|-----------|---------------|----------|
| | | | | | A | B | C | D | | | | | |
| 2431-87-11 | | Jack, Crimp, Panel, W/P, Keyed | F | Nickel | 1.550 | 0.930 | 0.090 | | 17 | 3-546-1 | KTH-2216 | * | 13 |
| 2431-87-16 | | Jack, Crimp, Panel, W/P, Keyed | F | Nickel | 1.550 | 0.930 | 0.090 | | 17 | 3-546-1 | KTH-2216 | * | 13 |
| 2431-87-3 | | Jack, Crimp, Panel, W/P, Keyed | F | Nickel | 1.550 | 0.930 | 0.090 | | 17 | 3-546-1 | KTH-2216 | * | 13 |
| 2431-87-6 | | Jack, Crimp, Panel, W/P, Keyed | F | Nickel | 1.550 | 0.930 | 0.090 | | 17 | 3-546-1 | KTH-2216 | * | 13 |
| 2431-83-1 | | Jack, Crimp, Panel, W/P, Keyed | F | Nickel | 1.930 | 0.930 | 0.090 | | 18 | 3-546-2 | KTH-2212 | * | 13 |
| 2431-83-11 | | Jack, Crimp, Panel, W/P, Keyed | F | Nickel | 1.930 | 0.930 | 0.090 | | 18 | 3-546-2 | KTH-2212 | * | 13 |
| 2431-83-16 | | Jack, Crimp, Panel, W/P, Keyed | F | Nickel | 1.930 | 0.930 | 0.090 | | 18 | 3-546-2 | KTH-2212 | * | 13 |
| 2431-88-1 | | Jack, Crimp, Panel, W/P, Keyed | F | Nickel | 1.930 | 0.930 | 0.090 | | 18 | 3-546-2 | KTH-2212 | * | 13 |
| 2431-88-11 | | Jack, Crimp, Panel, W/P, Keyed | F | Nickel | 1.930 | 0.930 | 0.090 | | 18 | 3-546-2 | KTH-2212 | * | 13 |
| 2431-88-16 | | Jack, Crimp, Panel, W/P, Keyed | F | Nickel | 1.930 | 0.930 | 0.090 | | 18 | 3-546-2 | KTH-2212 | * | 13 |
| 2431-88-6 | | Jack, Crimp, Panel, W/P, Keyed | F | Nickel | 1.930 | 0.930 | 0.090 | | 18 | 3-546-2 | KTH-2212 | * | 13 |
| 2431-89-1 | | Jack, Crimp, Panel, W/P, Keyed | F | Nickel | 2.030 | 0.930 | 0.090 | | 19 | 3-546-2 | KTH-2213 | * | 13 |
| 2431-89-11 | | Jack, Crimp, Panel, W/P, Keyed | F | Nickel | 2.030 | 0.930 | 0.090 | | 19 | 3-546-2 | KTH-2213 | * | 13 |
| 2431-89-16 | | Jack, Crimp, Panel, W/P, Keyed | F | Nickel | 2.030 | 0.930 | 0.090 | | 19 | 3-546-2 | KTH-2213 | * | 13 |
| 2431-89-6 | | Jack, Crimp, Panel, W/P, Keyed | F | Nickel | 2.030 | 0.930 | 0.090 | | 19 | 3-546-2 | KTH-2213 | * | 13 |
| 2431-74-1 | | Jack, Crimp, Panel, W/P, Keyed | F | Nickel | 1.520 | 0.930 | 0.090 | | 1 | CP-465 | KTH-2061 | * | 13 |
| 2431-74-11 | | Jack, Crimp, Panel, W/P, Keyed | F | Nickel | 1.520 | 0.930 | 0.090 | | 1 | CP-465 | KTH-2061 | * | 13 |
| 2431-74-16 | | Jack, Crimp, Panel, W/P, Keyed | F | Nickel | 1.520 | 0.930 | 0.090 | | 1 | CP-465 | KTH-2061 | * | 13 |
| 2431-74-2 | | Jack, Crimp, Panel, W/P, Keyed | F | Nickel | 1.520 | 0.930 | 0.090 | | 1 | CP-465 | KTH-2061 | * | 13 |
| 2431-74-3 | | Jack, Crimp, Panel, W/P, Keyed | F | Nickel | 1.520 | 0.930 | 0.090 | | 1 | CP-465 | KTH-2061 | * | 13 |
| 2431-74-4 | | Jack, Crimp, Panel, W/P, Keyed | F | Nickel | 1.520 | 0.930 | 0.090 | | 1 | CP-465 | KTH-2061 | * | 13 |
| 2431-74-6 | | Jack, Crimp, Panel, W/P, Keyed | F | Nickel | 1.520 | 0.930 | 0.090 | | 1 | CP-465 | KTH-2061 | * | 13 |
| 2431-90-1 | | Jack, Crimp, Panel, W/P, Keyed | F | Nickel | 1.460 | 0.930 | 0.090 | | B1 | 3-546-8 | KTH-2081 | * | 13 |
| 2431-90-11 | | Jack, Crimp, Panel, W/P, Keyed | F | Nickel | 1.460 | 0.930 | 0.090 | | B1 | 3-546-8 | KTH-2081 | * | 13 |
| 2431-90-16 | | Jack, Crimp, Panel, W/P, Keyed | F | Nickel | 1.460 | 0.930 | 0.090 | | B1 | 3-546-8 | KTH-2081 | * | 13 |
| 2431-90-6 | | Jack, Crimp, Panel, W/P, Keyed | F | Nickel | 1.460 | 0.930 | 0.090 | | B1 | 3-546-8 | KTH-2081 | * | 13 |
| 2431-91-1 | | Jack, Crimp, Panel, W/P, Keyed | F | Nickel | 1.550 | 0.930 | 0.090 | | 89 | 3-546-1 | KTH-2062 | * | 13 |
| 2431-91-11 | | Jack, Crimp, Panel, W/P, Keyed | F | Nickel | 1.550 | 0.930 | 0.090 | | 89 | 3-546-1 | KTH-2062 | * | 13 |
| 2431-91-6 | | Jack, Crimp, Panel, W/P, Keyed | F | Nickel | 1.550 | 0.930 | 0.090 | | 89 | 3-546-1 | KTH-2062 | * | 13 |
| 2431-82-1 | | Jack, Crimp, Panel, Iso Grnd, W/P, Keyed | F | Nickel | 1.720 | 1.130 | 0.090 | | 16 | 3-546-1 | KTH-2161 | * | 13 |
| 2431-82-11 | | Jack, Crimp, Panel, Iso Grnd, W/P, Keyed | F | Nickel | 1.720 | 1.130 | 0.090 | | 16 | 3-546-1 | KTH-2161 | * | 13 |
| 2431-82-16 | | Jack, Crimp, Panel, Iso Grnd, W/P, Keyed | F | Nickel | 1.720 | 1.130 | 0.090 | | 16 | 3-546-1 | KTH-2161 | * | 13 |
| 2431-82-2 | | Jack, Crimp, Panel, Iso Grnd, W/P, Keyed | F | Nickel | 1.720 | 1.130 | 0.090 | | 16 | 3-546-1 | KTH-2161 | * | 13 |
| 2431-82-5 | | Jack, Crimp, Panel, Iso Grnd, W/P, Keyed | F | Nickel | 1.720 | 1.130 | 0.090 | | 16 | 3-546-1 | KTH-2161 | * | 13 |
| 2431-82-6 | | Jack, Crimp, Panel, Iso Grnd, W/P, Keyed | F | Nickel | 1.720 | 1.130 | 0.090 | | 16 | 3-546-1 | KTH-2161 | * | 13 |

*Please Contact Customer Service for Additional Information

ANGLE PLUGS - K-GRIP, JR.

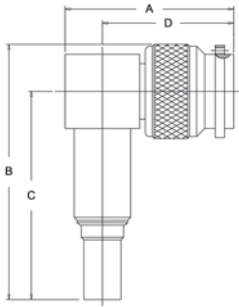

FIGURE 14

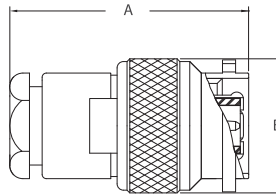

FIGURE 15

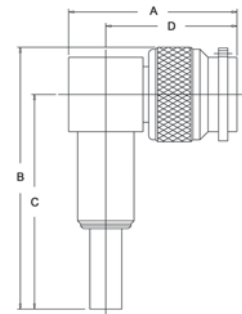

FIGURE 16

| Item Number | Military PN | Product Description | Gender | Finish | Dimensions | | | | Cable Group | Cable Procedure | Crimp Die | Mounting Hole | Figure # |
|---------------|----------------|---------------------------------------|--------|--------|------------|-------|-------|-------|-------------|-----------------|-----------|---------------|----------|
| | | | | | A | B | C | D | | | | | |
| KA-59-189 | | Plug, Crimp, Angle, W/P | M | Nickel | 1.130 | 1.730 | 0.640 | 0.890 | 45 | CP-5401 | KTH-2161 | | 14 |
| KA-59-186 | | Plug, Crimp, Angle, W/P | M | Nickel | 1.190 | 1.900 | 1.590 | 0.880 | 2 | CP-5402 | KTH-1079 | | 14 |
| 126-35-9 | | Plug, Crimp, Angle, W/P | M | Nickel | 1.190 | 1.870 | 1.550 | 0.880 | 8 | 3-440-2 | KTH-1077 | | 14 |
| 126-58-9 | | Plug, Crimp, Angle, W/P, Hex Nut | M | Nickel | 1.130 | 1.740 | 1.420 | 0.880 | 16 | 3-546-1 | KTH-2161 | | 14 |
| 126-71-7 | | Plug, Crimp, Angle, W/P | M | Nickel | 1.130 | 1.770 | 1.450 | 0.880 | 17 | 3-546-1 | KTH-2216 | | 14 |
| 126-71-9 | | Plug, Crimp, Angle, W/P, Hex Clpg Nut | M | Nickel | 1.130 | 1.770 | 1.450 | 0.880 | 17 | 3-546-1 | KTH-2216 | | 14 |
| 126-59-9 | | Plug, Crimp, Angle, W/P | M | Nickel | 1.190 | 1.870 | 1.550 | 0.880 | 18 | 3-546-2 | KTH-2212 | | 14 |
| 126-70-9 | | Plug, Crimp, Angle, W/P | M | Nickel | 3.050 | 1.810 | 1.500 | 2.740 | 18 | 3-546-2 | KTH-2212 | | 14 |
| 126-85-9 | | Plug, Crimp, Angle, W/P | M | Nickel | 1.220 | 1.920 | 1.550 | 0.880 | 18 | 3-546-2 | KTH-2212 | | 14 |
| 126-73-9 | | Plug, Crimp, Angle, W/P | M | Nickel | 1.190 | 1.960 | 1.640 | 0.880 | 19 | 3-546-2 | KTH-2213 | | 14 |
| 126-74-9 | | Plug, Crimp, Angle, W/P | M | Nickel | 1.190 | 1.960 | 1.640 | 0.880 | 20 | 3-546-2 | KTH-2229 | | 14 |
| KA-59-304 | | Plug, Crimp, Angle, W/P | M | Nickel | 1.130 | 1.820 | 1.450 | 0.890 | D | CP-5401 | KTH-2061 | | 14 |
| KA-59-439 M06 | | Plug, Crimp, Angle, W/P | M | Nickel | 1.120 | 1.740 | 1.420 | 0.880 | E1 | CP-5401 | KTH-2061 | | 14 |
| 126-63-9 | | Plug, Crimp, Angle, W/P | M | Nickel | 1.130 | 1.740 | 1.420 | 0.880 | E1 | CP-5402 | KTH-2061 | | 14 |
| 126-64-9 | | Plug, Crimp, Angle, W/P | M | Nickel | 3.050 | 1.900 | 1.590 | 2.740 | N3 | CP-5402 | KTH-2105 | | 14 |
| KA-59-138 | | Plug, Crimp, Angle | M | Silver | 1.250 | 1.790 | 0.750 | 1.490 | N1 | CP-209A | KTH-2004 | | 15 |
| KA-59-318 | | Plug, Crimp, Angle | M | Silver | 1.250 | 1.810 | 0.750 | 1.490 | N1,P | CP-209A | KTH-2004 | | 15 |
| KA-59-96 | | Plug, Crimp, Angle | M | Nickel | 1.220 | 1.810 | 0.750 | 1.490 | N1 | CP-209A | KTH-2004 | | 15 |
| KA-59-281 | | Plug, Angle, Preassembled | M | Silver | 1.120 | 1.630 | 1.320 | 0.870 | B | CP-465 | KTH-2011 | | 16 |
| 126-8-5 | M39012/30-0022 | Preassembled | M | Silver | 1.120 | 1.630 | 1.320 | 0.870 | B1 | CP-465 | KTH-2011 | | 16 |
| KA-59-70 M06 | | Plug, Crimp, Angle | M | Nickel | 1.040 | 1.450 | 1.150 | 0.850 | B1 | CP-406 | KTH-2032 | | 16 |
| KA-59-295 | M39012/30-0502 | Plug, Crimp, Angle | M | Silver | 1.130 | 1.790 | 1.420 | 0.890 | C2 | CP-465 | KTH-2007 | | 16 |
| KA-59-235 | M39012/30-0010 | Plug, Crimp, Angle | M | Silver | 1.120 | 1.400 | 1.080 | 0.870 | D | CP-465 | KTH-2001 | | 16 |
| KA-59-297 | M39012/30-0504 | Plug, Crimp, Angle | M | Silver | 1.130 | 1.790 | 1.420 | 0.890 | D | CP-465 | KTH-2001 | | 16 |
| 126-79-5 | | Plug, Crimp, Angle | M | Silver | 1.210 | 1.850 | 1.460 | 0.880 | E1 | CP-465 | KTH-2001 | | 16 |
| KA-59-236 | M39012/30-0011 | Plug, Crimp, Angle | M | Silver | 1.120 | 1.400 | 1.080 | 0.870 | E1 | CP-465 | KTH-2001 | | 16 |
| KA-59-296 | M39012/30-0503 | Plug, Crimp, Angle | M | Silver | 1.130 | 1.790 | 1.420 | 0.890 | E1 | CP-465 | KTH-2001 | | 16 |
| KA-59-72 | | Plug, Crimp, Angle | M | Silver | 1.040 | 1.630 | 1.340 | 0.850 | E1 | CP-401 | KTH-2001 | | 16 |
| KA-59-237 | M39012/30-0012 | Plug, Crimp, Angle | M | Silver | 1.120 | 1.400 | 1.080 | 0.870 | G1 | CP-465 | KTH-2002 | | 16 |
| KA-59-208 | | Plug, Crimp, Angle | M | Nickel | 1.110 | 1.690 | 1.390 | 0.840 | M1 | CP-416 | KTH-2003 | | 16 |
| 126-14-5 | | Plug, Crimp, Angle | M | Nickel | 1.190 | 1.900 | 1.590 | 0.880 | N3 | CP-5402 | KTH-2105 | | 16 |
| 126-68-5 | | Plug, Crimp, Angle | M | Silver | 1.210 | 1.870 | 1.420 | 0.690 | | CP-465 | KTH-2001 | | 16 |
| 126-12-5 | | Plug, Crimp, Angle | M | Silver | 1.130 | 1.790 | 1.420 | 0.880 | | CP-465 | KTH-2007 | | 16 |
| 126-86-3 | | Plug, Crimp, Angle, Hex | M | | 1.120 | 1.740 | 1.420 | 0.880 | | CP-465 | KTH-2007 | | 16 |
| 126-69-5 | | Plug, Crimp, Angle | M | Silver | 1.190 | 2.510 | 1.500 | 0.880 | | CP-5402 | KTH-2012 | | 16 |

PLUGS - CONVENTIONAL, K-GRIP

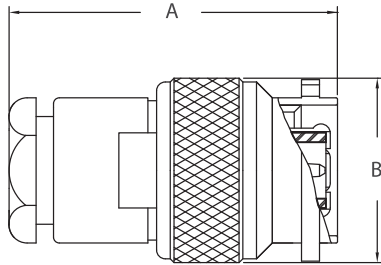

FIGURE 17

ANGLE PLUG - CONVENTIONAL

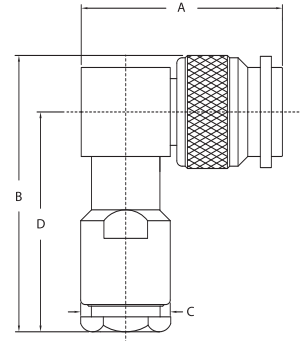

FIGURE 18

ATTENUATOR

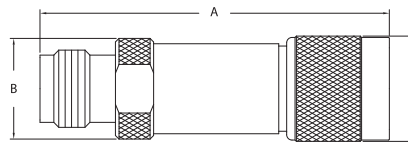

FIGURE 19

| Item Number | Military PN | Product Description | Gender | Finish | Dimensions | | | | Cable Group | Cable Procedure | Crimp Die | Mounting Hole | Figure # |
|--------------|----------------|----------------------------------|--------|--------|------------|-------|-------|-------|-------------|-----------------|-----------|---------------|----------|
| | | | | | A | B | C | D | | | | | |
| KA-59-289 | M39012/26-0013 | Plug, Conventional | M | Silver | 1.080 | 0.630 | | | B1 | CP-1050 | | | 17 |
| KA-51-18 | | Plug, Conventional | M | Silver | 1.090 | 0.590 | 0.590 | | DE | CP-1004 | | | 17 |
| KA-59-22 | M39012/26-0101 | Plug, Conventional | M | Silver | 1.080 | 0.630 | 0.630 | | DE | CP-1050 | | | 17 |
| 125-67-5 | M39012/26-0101 | Plug, Conventional | M | Silver | 1.120 | 0.630 | | | DE | CP-1050 | | | 17 |
| KA-59-18 | M39012/26-0102 | Plug, Conventional | M | Silver | 1.090 | 0.630 | | | G1 | CP-1050 | | | 17 |
| KA-51-19 | | Plug, Conventional | M | Silver | 1.670 | 0.590 | 0.590 | | MN | CP-1005 | | | 17 |
| 125-25-5 | | Plug, Conventional | M | Silver | 1.090 | 0.640 | | | | CP-465 | | | 17 |
| KA-59-29 | | Plug, Crimp | M | Silver | 1.180 | 0.630 | | | D | CP-201A | KTH-2001 | | 17 |
| KA-59-435 | | Plug, Crimp | M | Nickel | 1.690 | 0.750 | | | N1 | CP-230A | KTH-2004 | | 17 |
| KA-59-146 | | Plug, Crimp | M | Silver | 1.680 | 0.750 | | | N3 | CP-209A | KTH-2004 | | 17 |
| KA-59-267 | | Plug, Crimp | M | Silver | 1.690 | 0.630 | | | P | CP-230A | KTH-2004 | | 17 |
| KA-59-85 M07 | | Plug, Crimp, Angle, Hex Cplg Nut | M | Silver | 1.490 | 1.250 | 0.750 | 0.560 | K3 | CP-209A | KTH-2012 | | 17 |
| KA-59-348 | M39012/30-0118 | Plug, Conventional, Angle | M | Silver | 1.130 | 1.560 | 0.500 | 1.250 | B1 | CP-1050 | | | 18 |
| KA-59-343 | M39012/30-0101 | Plug, Conventional, Angle | M | Silver | 1.130 | 1.560 | 0.500 | 1.250 | DE | CP-1050 | | | 18 |
| 126-55-5 | M39012/30-0101 | Plug, Conventional, Angle | M | Silver | 1.218 | 1.750 | | 1.330 | DE | 3-526 | | | 18 |
| 126-54-5 | M39012/30-0102 | Plug, Conventional, Angle | M | Silver | 1.218 | 1.750 | 0.440 | 1.330 | G1 | 3-526 | | | 18 |
| 1800-10 | | Attenuator | M-F | Nickel | 1.950 | 0.560 | 0.590 | | | | | | 19 |
| 1800-11 | | Attenuator | M-F | Nickel | 1.950 | 0.560 | 0.590 | | | | | | 19 |
| 1800-4 | | Attenuator | M-F | Nickel | 1.950 | 0.560 | 0.590 | | | | | | 19 |
| 1800-6 | | Attenuator | M-F | Nickel | 1.950 | 0.560 | 0.590 | | | | | | 19 |
| 1800-7 | | Attenuator | M-F | Nickel | 1.950 | 0.560 | 0.590 | | | | | | 19 |

ANGLE PLUGS - K-GRIP, JR., KEYED

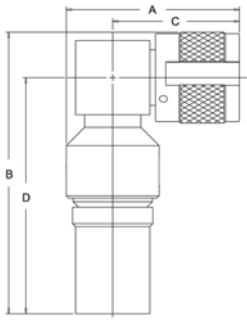

FIGURE 20

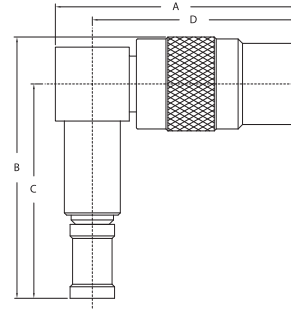

FIGURE 21

PLUGS - K-GRIP, JR., KEYED

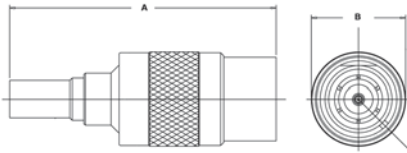

FIGURE 22

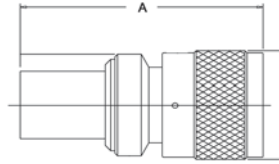

FIGURE 23

| Item Number | Military PN | Product Description | Gender | Finish | Dimensions | | | | Cable Group | Cable Procedure | Crimp Die | Mounting Hole | Figure # |
|-------------|-------------|--------------------------------|--------|--------|------------|-------|-------|-------|-------------|-----------------|-----------|---------------|----------|
| | | | | | A | B | C | D | | | | | |
| KA-59-324 | | Plug, Crimp, Angle, W/P, Keyed | M | Silver | 1.160 | 1.900 | 0.850 | 1.590 | N3 | CP-5402 | KTH-2105 | | 20 |
| 2436-80-1 | | Plug, Crimp, Angle, W/P, Keyed | M | | 1.550 | 1.760 | 1.450 | 1.300 | 1 | CP-465 | KTH-2061 | | 21 |
| 2436-81-1 | | Plug, Crimp, Angle, W/P, Keyed | M | Nickel | 1.600 | 1.740 | 1.410 | 1.350 | 16 | 3-546-1 | KTH-2161 | | 21 |
| 2436-81-11 | | Plug, Crimp, Angle, W/P, Keyed | M | Nickel | 1.600 | 1.740 | 1.410 | 1.350 | 16 | 3-546-1 | KTH-2161 | | 21 |
| 2436-81-16 | | Plug, Crimp, Angle, W/P, Keyed | M | Nickel | 1.600 | 1.740 | 1.410 | 1.350 | 16 | 3-546-1 | KTH-2161 | | 21 |
| 2436-81-2 | | Plug, Crimp, Angle, W/P, Keyed | M | Nickel | 1.600 | 1.740 | 1.410 | 1.350 | 16 | 3-546-1 | KTH-2161 | | 21 |
| 2436-81-21 | | Plug, Crimp, Angle, W/P, Keyed | M | Nickel | 1.600 | 1.740 | 1.410 | 1.350 | 16 | 3-546-1 | KTH-2161 | | 21 |
| 2436-81-6 | | Plug, Crimp, Angle, W/P, Keyed | M | Nickel | 1.600 | 1.740 | 1.410 | 1.350 | 16 | 3-546-1 | KTH-2161 | | 21 |
| 2436-83-1 | | Plug, Crimp, Angle, W/P, Keyed | M | Nickel | 1.660 | 1.870 | 1.550 | 1.350 | 18 | 3-546-2 | KTH-2212 | | 21 |
| 2436-83-11 | | Plug, Crimp, Angle, W/P, Keyed | M | Nickel | 1.660 | 1.870 | 1.550 | 1.350 | 18 | 3-546-2 | KTH-2212 | | 21 |
| 2436-83-16 | | Plug, Crimp, Angle, W/P, Keyed | M | Nickel | 1.660 | 1.870 | 1.550 | 1.350 | 18 | 3-546-2 | KTH-2212 | | 21 |
| 2436-83-24 | | Plug, Crimp, Angle, W/P, Keyed | M | Nickel | 1.660 | 1.870 | 1.550 | 1.350 | 18 | 3-546-2 | KTH-2212 | | 21 |
| 2436-83-6 | | Plug, Crimp, Angle, W/P, Keyed | M | Nickel | 1.660 | 1.870 | 1.550 | 1.350 | 18 | 3-546-2 | KTH-2212 | | 21 |
| 2436-83-9 | | Plug, Crimp, Angle, W/P, Keyed | M | Nickel | 1.660 | 1.870 | 1.550 | 1.350 | 18 | 3-546-2 | KTH-2212 | | 21 |
| 2436-85-1 | | Plug, Crimp, Angle, W/P, Keyed | M | Nickel | 1.660 | 1.930 | 1.640 | 1.350 | 19 | 3-546-2 | KTH-2213 | | 21 |
| 2436-85-6 | | Plug, Crimp, Angle, W/P, Keyed | M | Nickel | 1.660 | 1.930 | 1.640 | 1.350 | 19 | 3-546-2 | KTH-2213 | | 21 |
| 2436-82-1 | | Plug, Crimp, Angle, W/P, Keyed | M | Silver | 1.650 | 1.900 | 1.590 | 1.340 | N3 | CP-5402 | KTH-2105 | | 21 |
| 2436-82-10 | | Plug, Crimp, Angle, W/P, Keyed | M | Silver | 1.650 | 1.900 | 1.590 | 1.340 | N3 | CP-5402 | KTH-2105 | | 21 |
| 2436-82-5 | | Plug, Crimp, Angle, W/P, Keyed | M | Silver | 1.650 | 1.900 | 1.590 | 1.340 | N3 | CP-5402 | KTH-2105 | | 21 |
| 2436-6-3 | | Plug, Crimp, Angle, Keyed | M | | 1.540 | 1.740 | 1.420 | 1.290 | | CP-465 | KTH-2007 | | N/S |
| 126-1-2 | | Plug, Crimp, Angle, Keyed | M | Silver | 1.210 | 2.000 | 1.420 | 0.850 | E1 | CP-465 | KTH-2001 | | N/S |
| 126-4-1 | | Plug, Crimp, Angle, Keyed | M | Silver | 1.210 | 2.000 | 1.420 | 0.850 | C2 | CP-465 | KTH-2007 | | N/S |
| 2435-77-1 | | Plug, Crimp, W/P, Keyed | M | Nickel | 2.220 | 0.640 | | | 2 | CP-5402 | KTH-1079 | | 22 |
| 2435-77-11 | | Plug, Crimp, W/P, Keyed | M | Nickel | 2.220 | 0.640 | | | 2 | CP-5402 | KTH-1079 | | 22 |
| 2435-77-16 | | Plug, Crimp, W/P, Keyed | M | Nickel | 2.220 | 0.640 | | | 2 | CP-5402 | KTH-1079 | | 22 |
| 2435-77-6 | | Plug, Crimp, W/P, Keyed | M | Nickel | 2.220 | 0.640 | | | 2 | CP-5402 | KTH-1079 | | 22 |

| Item Number | Military PN | Product Description | Gender | Finish | Dimensions | | | | Cable Group | Cable Procedure | Crimp Die | Mounting Hole | Figure # |
|-------------|-------------|----------------------------------|--------|--------|------------|-------|---|---|-------------|-----------------|-----------|---------------|----------|
| | | | | | A | B | C | D | | | | | |
| 2435-82-1 | | Plug, Crimp, W/P, Keyed | M | Nickel | 1.800 | 0.650 | | | 15 | 3-546-1 | KTH-2214 | 22 | |
| 2435-82-6 | | Plug, Crimp, W/P, Keyed | M | Nickel | 1.800 | 0.650 | | | 15 | 3-546-1 | KTH-2214 | 22 | |
| 2435-81-1 | | Plug, Crimp, W/P, Keyed | M | Nickel | 1.580 | 0.650 | | | 16 | 3-546-1 | KTH-2161 | 22 | |
| 2435-81-11 | | Plug, Crimp, W/P, Keyed | M | Nickel | 1.580 | 0.650 | | | 16 | 3-546-1 | KTH-2161 | 22 | |
| 2435-81-16 | | Plug, Crimp, W/P, Keyed | M | Nickel | 1.580 | 0.650 | | | 16 | 3-546-1 | KTH-2161 | 22 | |
| 2435-81-2 | | Plug, Crimp, W/P, Keyed | M | Nickel | 1.580 | 0.650 | | | 16 | 3-546-1 | KTH-2161 | 22 | |
| 2435-81-20 | | Plug, Crimp, W/P, Keyed | M | Nickel | 1.580 | 0.650 | | | 16 | 3-546-1 | KTH-2161 | 22 | |
| 2435-81-5 | | Plug, Crimp, W/P, Keyed | M | Nickel | 1.580 | 0.650 | | | 16 | 3-546-1 | KTH-2161 | 22 | |
| 2435-81-6 | | Plug, Crimp, W/P, Keyed | M | Nickel | 1.580 | 0.650 | | | 16 | 3-546-1 | KTH-2161 | 22 | |
| 2435-81-9 | | Plug, Crimp, W/P, Keyed | M | Nickel | 1.580 | 0.650 | | | 16 | 3-546-1 | KTH-2161 | 22 | |
| 2435-84-1 | | Plug, Crimp, Weatherproof, Keyed | M | Nickel | 1.610 | 0.650 | | | 17 | 3-546-1 | KTH-2216 | 22 | |
| 2435-84-11 | | Plug, Crimp, Weatherproof, Keyed | M | Nickel | 1.610 | 0.650 | | | 17 | 3-546-1 | KTH-2216 | 22 | |
| 2435-84-16 | | Plug, Crimp, Weatherproof, Keyed | M | Nickel | 1.610 | 0.650 | | | 17 | 3-546-1 | KTH-2216 | 22 | |
| 2435-84-3 | | Plug, Crimp, Weatherproof, Keyed | M | Nickel | 1.610 | 0.650 | | | 17 | 3-546-1 | KTH-2216 | 22 | |
| 2435-84-5 | | Plug, Crimp, Weatherproof, Keyed | M | Nickel | 1.610 | 0.650 | | | 17 | 3-546-1 | KTH-2216 | 22 | |
| 2435-84-6 | | Plug, Crimp, Weatherproof, Keyed | M | Nickel | 1.610 | 0.650 | | | 17 | 3-546-1 | KTH-2216 | 22 | |
| 2435-83-1 | | Plug, Crimp, Weatherproof, Keyed | M | Nickel | 2.130 | 0.650 | | | 18 | 3-546-2 | KTH-2212 | 22 | |
| 2435-83-11 | | Plug, Crimp, Weatherproof, Keyed | M | Nickel | 2.130 | 0.650 | | | 18 | 3-546-2 | KTH-2212 | 22 | |
| 2435-83-16 | | Plug, Crimp, Weatherproof, Keyed | M | Nickel | 2.130 | 0.650 | | | 18 | 3-546-2 | KTH-2212 | 22 | |
| 2435-83-6 | | Plug, Crimp, Weatherproof, Keyed | M | Nickel | 2.130 | 0.650 | | | 18 | 3-546-2 | KTH-2212 | 22 | |
| 2435-87-1 | | Plug, Crimp, Weatherproof, Keyed | M | Nickel | 2.215 | 0.650 | | | 19 | 3-546-2 | KTH-2213 | 22 | |
| 2435-87-11 | | Plug, Crimp, Weatherproof, Keyed | M | Nickel | 2.215 | 0.650 | | | 19 | 3-546-2 | KTH-2213 | 22 | |
| 2435-87-16 | | Plug, Crimp, Weatherproof, Keyed | M | Nickel | 2.215 | 0.650 | | | 19 | 3-546-2 | KTH-2213 | 22 | |
| 2435-87-6 | | Plug, Crimp, Weatherproof, Keyed | M | Nickel | 2.215 | 0.650 | | | 19 | 3-546-2 | KTH-2213 | 22 | |
| 2435-89-1 | | Plug, Crimp, Weatherproof, Keyed | M | Nickel | 2.330 | 0.650 | | | 20 | 3-546-2 | KTH-2229 | 22 | |
| 2435-89-11 | | Plug, Crimp, Weatherproof, Keyed | M | Nickel | 2.330 | 0.650 | | | 20 | 3-546-2 | KTH-2229 | 22 | |
| 2435-89-16 | | Plug, Crimp, Weatherproof, Keyed | M | Nickel | 2.330 | 0.650 | | | 20 | 3-546-2 | KTH-2229 | 22 | |
| 2435-89-6 | | Plug, Crimp, Weatherproof, Keyed | M | Nickel | 2.330 | 0.650 | | | 20 | 3-546-2 | KTH-2229 | 22 | |
| 2435-74-1 | | Plug, Crimp, Weatherproof, Keyed | M | Nickel | 1.580 | 0.650 | | | E1 | CP-465 | KTH-2061 | 22 | |
| 2435-74-11 | | Plug, Crimp, Weatherproof, Keyed | M | Nickel | 1.580 | 0.650 | | | E1 | CP-465 | KTH-2061 | 22 | |
| 2435-74-16 | | Plug, Crimp, Weatherproof, Keyed | M | Nickel | 1.580 | 0.650 | | | E1 | CP-465 | KTH-2061 | 22 | |
| 2435-74-3 | | Plug, Crimp, Weatherproof, Keyed | M | Nickel | 1.580 | 0.650 | | | E1 | CP-465 | KTH-2061 | 22 | |
| 2435-74-6 | | Plug, Crimp, Weatherproof, Keyed | M | Nickel | 1.580 | 0.650 | | | E1 | CP-465 | KTH-2061 | 22 | |
| 2435-88-1 | | Plug, Crimp, W/P, Keyed | M | Nickel | 1.580 | 0.640 | | | 89 | 3-440-3 | KTH-2062 | 22 | |
| 2435-88-11 | | Plug, Crimp, W/P, Keyed | M | Nickel | 1.580 | 0.640 | | | 89 | 3-440-3 | KTH-2062 | 22 | |
| 2435-88-16 | | Plug, Crimp, W/P, Keyed | M | Nickel | 1.580 | 0.640 | | | 89 | 3-440-3 | KTH-2062 | 22 | |
| 2435-88-6 | | Plug, Crimp, W/P, Keyed | M | Nickel | 1.580 | 0.640 | | | 89 | 3-440-3 | KTH-2062 | 22 | |
| 125-4-1 | | Plug, Crimp, Keyed | M | Silver | 1.500 | 0.610 | | | C2 | CP-465 | | N/S | |
| 125-4-2 | | Plug, Crimp, Keyed | M | Silver | 1.500 | 0.610 | | | C2 | CP-465 | KTH-2007 | N/S | |
| 125-86-1 | | Plug, Crimp, Keyed | M | Silver | 1.240 | 0.610 | | | D | CP-465 | KTH-2001 | N/S | |
| 125-1-1 | | Plug, Crimp, Keyed | M | Silver | 1.240 | 0.610 | | | E1 | CP-465 | KTH-2001 | N/S | |
| 125-1-6 | | Plug, Crimp, Keyed | M | Silver | 1.500 | 0.610 | | | E1 | CP-465 | KTH-2001 | N/S | |
| 125-52-1 | | Plug, Crimp, Keyed | M | Silver | 2.000 | 0.610 | | | 11 | CP-5402 | KTH-2012 | 23 | |
| 125-52-2 | | Plug, Crimp, Keyed | M | Silver | 2.000 | 0.610 | | | 11 | CP-5402 | KTH-2012 | 23 | |
| 125-52-3 | | Plug, Crimp, Keyed | M | Silver | 2.000 | 0.610 | | | 11 | CP-5402 | KTH-2012 | 23 | |
| 125-52-4 | | Plug, Crimp, Keyed | M | Silver | 2.000 | 0.610 | | | 11 | CP-5402 | KTH-2012 | 23 | |

PLUG - K-GRIP, JR.

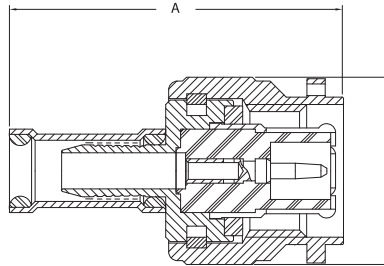

FIGURE 24

| Item Number | Military PN | Product Description | Gender | Finish | Dimensions | | | | Cable Group | Cable Procedure | Crimp Die | Mounting Hole | Figure # |
|---------------|-------------|-----------------------------------|--------|--------|------------|-------|---|---|-------------|-----------------|-----------|---------------|----------|
| | | | | | A | B | C | D | | | | | |
| KA-59-167 | | Plug, Crimp, W/P | M | Nickel | 1.110 | 0.590 | | | | | KTH-2062 | | 24 |
| KA-59-185 | | Plug, Crimp, W/P | M | Nickel | 1.830 | 0.630 | | | 2 | CP-5402 | KTH-1079 | | 24 |
| KA-59-185 MC7 | | Plug, Crimp, W/P | M | Silver | 1.830 | 0.630 | | | 2 | CP-5402 | KTH-1079 | | 24 |
| 125-57-9 | | Plug, Crimp, W/P | M | Nickel | 1.740 | 0.640 | | | 8 | 3-440-2 | KTH-1077 | | 24 |
| 125-58-9 | | Plug, Crimp, W/P | M | Nickel | 1.140 | 0.640 | | | 10 | 3-440-3 | KTH-2061 | | 24 |
| KA-59-391 M06 | | Plug, Crimp, W/P | M | Nickel | 1.740 | 0.630 | | | 12 | CP-5402 | KTH-2127 | | 24 |
| 125-89-9 | | Plug, Crimp, W/P | M | Nickel | 1.330 | 0.560 | | | 15 | 3-546-1 | KTH-2214 | | 24 |
| 125-88-9 | | Plug, Crimp, W/P | M | Nickel | 1.110 | 0.560 | | | 16 | 3-546-1 | KTH-2161 | | 24 |
| 125-94-9 | | Plug, Crimp, W/P | M | Gold | 1.110 | 0.500 | | | 16 | 3-546-1 | KTH-2161 | | 24 |
| 125-95-7 | | Plug, Crimp, W/P | M | Nickel | 1.140 | 0.640 | | | 17 | 3-546-1 | KTH-2216 | | 24 |
| 125-95-9 | | Plug, Crimp, W/P | M | Nickel | 1.140 | 0.560 | | | 17 | 3-546-1 | KTH-2216 | | 24 |
| 125-96-9 | | Plug, Crimp, Weatherproof | M | Gold | 1.140 | 0.500 | | | 17 | 3-546-1 | KTH-2216 | | 24 |
| 125-101-9 | | Plug, Crimp, Weatherproof | M | Nickel | 1.660 | 0.560 | | | 18 | 3-546-2 | KTH-2212 | | 24 |
| 125-117-9 | | Plug, Crimp, Weatherproof | M | Nickel | 1.660 | 0.760 | | | 18 | 3-546-2 | KTH-2212 | | 24 |
| 125-91-9 | | Plug, Crimp, Weatherproof | M | Nickel | 1.690 | 0.560 | | | 18 | 3-546-2 | KTH-2212 | | 24 |
| 125-92-9 | | Plug, Crimp, Weatherproof | M | Nickel | 2.000 | 0.640 | | | 19 | 3-546-2 | KTH-2213 | | 24 |
| 125-105-9 | | Plug, Crimp, Weatherproof | M | Nickel | 1.840 | 0.640 | | | 20 | 3-546-2 | KTH-2229 | | 24 |
| KA-59-260 | | Plug, Crimp, Weatherproof | M | Nickel | 1.040 | 0.590 | | | B1 | CP-402 | KTH-2081 | | 24 |
| 615-11-9 | | Plug, Crimp, Weatherproof, 75 Ohm | M | Nickel | 1.210 | 0.570 | | | B2 | 3-661-4 | KTH-2277 | | 24 |
| 125-69-9 | | Plug, Crimp, Weatherproof | M | Nickel | 1.110 | 0.640 | | | C2 | CP-5401 | KTH-2067 | | 24 |
| KA-59-277 | | Plug, Crimp, Weatherproof | M | Nickel | 1.140 | 0.630 | | | D | CP-5401 | KTH-2061 | | 24 |
| KA-59-438 M06 | | Plug, Crimp, W/P | M | Nickel | 1.110 | 0.630 | | | E1 | CP-465 | KTH-2061 | | 24 |
| KA-59-251 | | Plug, Crimp, W/P | M | Nickel | 1.120 | 0.630 | | | E1 | CP-472 | KTH-2061 | | 24 |
| 125-98-9 | | Plug, Crimp, W/P, Hex Cplg Nut | M | Nickel | 1.110 | 0.610 | | | E1 | CP-5401 | KTH-2061 | | 24 |
| KA-59-353 M06 | | Plug, Crimp, W/P | M | Nickel | 1.830 | 0.630 | | | N3 | CP-5402 | KTH-2105 | | 24 |
| 125-61-9 | | Plug, Crimp, W/P | M | Nickel | 1.250 | 0.640 | | | | CP-402 | KTH-2081 | | 24 |
| KA-59-375 M07 | | Plug, Crimp, W/P | M | Silver | 1.110 | 0.630 | | | | CP-465 | KTH-2120 | | 24 |
| KA-59-392 M06 | | Plug, Crimp, W/P | M | Nickel | 1.140 | 0.630 | | | | CP-5401 | KTH-2128 | | 24 |
| KA-59-188 | | Plug, Crimp, W/P | M | Nickel | 1.100 | 0.630 | | | 45 | CP-5401 | KTH-2161 | | 24 |

PLUG - K-GRIP, JR.



FIGURE 25

TERMINATION

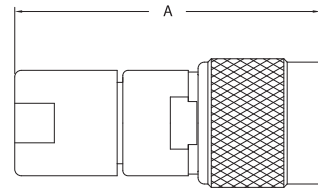

FIGURE 26

ANGLE RECEPTACLE

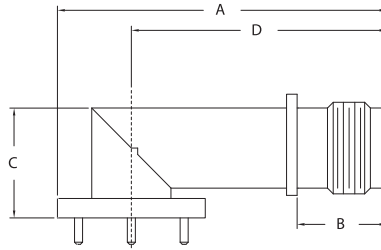

FIGURE 27

| Item Number | Military PN | Product Description | Gender | Finish | Dimensions | | | | Cable Group | Cable Procedure | Crimp Die | Mounting Hole | Figure # |
|---------------|----------------|------------------------|--------|--------|------------|-------|-------|-------|-------------|-----------------|-----------|---------------|----------|
| | | | | | A | B | C | D | | | | | |
| KA-59-290 | M39012/26-0501 | Plug, Crimp | M | Silver | 1.110 | 0.630 | | | C1 | CP-465 | KTH-2007 | | 25 |
| 125-19-5 | M39012/26-0022 | Plug, Crimp | M | Silver | 1.460 | 0.640 | | | B1 | CP-465 | KTH-2011 | | 25 |
| KA-59-69 | | Plug, Crimp | M | Silver | 0.940 | 0.590 | | | B1 | CP-406 | KTH-2032 | | 25 |
| KA-59-291 | M39012/26-0502 | Plug, Crimp | M | Silver | 1.110 | 0.630 | | | C2 | CP-465 | KTH-2007 | | 25 |
| KA-59-103 | | Plug, Crimp | M | Nickel | 1.100 | 0.590 | | | D | CP-401 | KTH-2001 | | 25 |
| KA-59-220 | | Plug, Crimp, Polarized | M | Nickel | 1.080 | 0.590 | | | D | CP-401 | KTH-2001 | | 25 |
| KA-59-406 M06 | | Plug, Crimp | M | Nickel | 1.100 | 0.590 | | | D | CP-401 | KTH-2001 | | 25 |
| KA-59-231 | M39012/26-0010 | Plug, Crimp | M | Silver | 1.080 | 0.630 | | | D | CP-465 | KTH-2001 | | 25 |
| KA-59-287 | M39012/26-0504 | Plug, Crimp | M | Silver | 1.110 | 0.630 | | | D | CP-465 | KTH-2001 | | 25 |
| 125-114-5 | | Plug, Crimp | M | Silver | 1.180 | 0.640 | | | E1 | CP-465 | KTH-2001 | | 25 |
| KA-59-230 | M39012/26-0011 | Plug, Crimp | M | Silver | 1.080 | 0.630 | | | E1 | CP-465 | KTH-2001 | | 25 |
| KA-59-263 | | Plug, Crimp | M | Nickel | 1.080 | 0.630 | | | E1 | CP-465 | KTH-2001 | | 25 |
| KA-59-292 | M39012/26-0503 | Plug, Crimp | M | Silver | 1.110 | 0.630 | | | E1 | CP-465 | KTH-2001 | | 25 |
| KA-59-232 | M39012/26-0012 | Plug, Crimp | M | Silver | 1.060 | 0.630 | | | G1 | CP-465 | KTH-2002 | | 25 |
| KA-59-279 | M39012/26-0021 | Plug, Crimp | M | Silver | 1.080 | 0.630 | | | H | CP-465 | KTH-2002 | | 25 |
| 125-80-9 | | Plug, Crimp | M | Nickel | 1.090 | 0.590 | | | | 3-491 | KTH-2002 | | 25 |
| 128-30-9 | | Plug, Crimp, W/O Pin | M | Nickel | 0.930 | 0.590 | | | | 3-491 | KTH-2002 | | 25 |
| 125-103-5 | | Plug, Crimp | M | Silver | 2.030 | 0.640 | | | | CP-5402 | KTH-2012 | | 25 |
| 125-104-5 | | Plug, Crimp | M | Silver | 2.030 | 0.640 | | | | CP-5402 | KTH-2012 | | 25 |
| KA-89-15 | | Termination | M | Nickel | 1.420 | | | | | | | | 26 |
| 127-26-9 | | Receptacle, PCB, Angle | F | Nickel | 1.520 | N/A | 0.520 | 0.990 | | | | | N/S |
| 2437-4-5 | | Receptacle, PCB, Angle | F | Nickel | 1.520 | 0.431 | 0.520 | 1.180 | | | | | 27 |

BULKHEAD RECEPTACLES

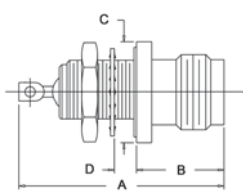

FIGURE 28



FIGURE 29



FIGURE 30

PANEL RECEPTACLES

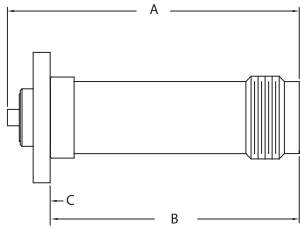

FIGURE 31

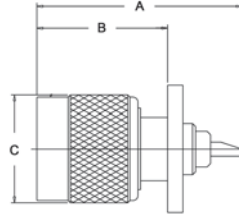

FIGURE 32



FIGURE 33

| Item Number | Military PN | Product Description | Gender | Finish | Dimensions | | | | Cable Group | Cable Procedure | Crimp Die | Mounting Hole | Figure # |
|---------------|----------------|----------------------------------|--------|--------|------------|-------|-------|-------|-------------|-----------------|-----------|---------------|----------|
| | | | | | A | B | C | D | | | | | |
| KA-71-04 | M39012/34-0002 | Receptacle, Bulkhd, Hermetic | F | Silver | 1.210 | 0.520 | 0.590 | 0.273 | | | | H | 28 |
| KA-79-28 | | Receptacle, Bulkhead | F | Nickel | 1.060 | 0.470 | 0.500 | 0.132 | | | | H | 29 |
| KA-79-56 | | Receptacle, Bulkhead | M | Nickel | 1.190 | 0.670 | 0.590 | | | | | H | N/S |
| KA-79-59 | | Receptacle, Iso Ground, Bulkhead | F | Nickel | 1.060 | 0.520 | 0.560 | 0.174 | | | | X | 29 |
| KA-71-02 | M39012/31-0001 | Receptacle, Bulkhd | F | Silver | 1.050 | 0.480 | 0.500 | 0.135 | | | | AB | 29 |
| KA-71-08 | M39012/31-0002 | Receptacle, Bulkhd | F | Silver | 1.190 | 0.470 | 0.500 | 0.260 | | | | H | 29 |
| KA-71-03 | M39012/34-0001 | Receptacle, Bulkhd, Hermetic | F | Silver | 1.210 | 0.830 | 0.680 | | | | | X | N/S |
| KA-79-165 M06 | | Receptacle, PCB, Bulkhd | F | Nickel | 1.450 | 0.810 | 0.090 | 0.090 | | | | X | 30 |
| 127-15 | | Receptacle, Panel | F | Nickel | 1.560 | 1.300 | 0.090 | | | | | * | 31 |
| 127-19-9 | | Receptacle, Panel | F | Nickel | 1.540 | 1.310 | 0.090 | | | | | * | 31 |
| 127-20-9 | | Receptacle, Panel | F | Nickel | 1.600 | 1.310 | 0.090 | | | | | * | 31 |
| KA-79-161 MC9 | | Receptacle, Panel, Hermetic | F | Gold | 0.830 | 0.530 | | | | | | | 31 |
| 2437-2-0 | | Receptacle, Panel | F | Nickel | 1.590 | 1.530 | 0.110 | | | | | * | 31 |
| KA-71-09 | | Receptacle, Panel | M | Silver | 1.170 | 0.750 | 0.590 | | | | | * | 32 |
| KA-79-157 M06 | | Receptacle, Panel | M | Nickel | 1.170 | 0.750 | 0.090 | | | | | * | 32 |
| KA-79-118 | | Receptacle, Panel | F | Nickel | 1.060 | 0.620 | 0.090 | | | | | * | 33 |
| KA-79-156 M06 | | Receptacle, Panel | F | Nickel | 0.860 | 0.430 | 0.090 | | | | | * | 33 |
| KA-79-39 | M39012/32-0001 | Receptacle, Panel | F | Silver | 1.060 | 0.620 | 0.090 | | | | | * | 33 |
| K-4944 | | Body Assembly | M | Nickel | 1.080 | 0.480 | | | E1 | CP-5401 | KTH-2061 | | N/S |

*Please Contact Customer Service for Additional Information

ADAPTERS - WITHIN SERIES



FIGURE 34



FIGURE 35

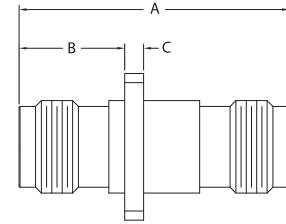

FIGURE 36

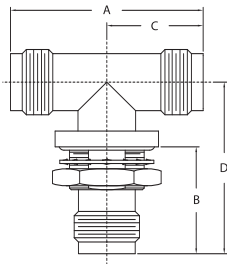

FIGURE 37



FIGURE 38



FIGURE 39

| Item Number | Military PN | Product Description | Gender | Finish | Dimensions | | | | Cable Group | Cable Procedure | Crimp Die | Mounting Hole | Figure # |
|---------------|-----------------|---|--------|--------|------------|-------|-------|-------|-------------|-----------------|-----------|---------------|----------|
| | | | | | A | B | C | D | | | | | |
| KA-99-56 | | Within Series Adapter, Bulkhd, Hermetic | F-F | Nickel | 1.390 | 0.730 | | | | | X | 34 | |
| KA-91-02 | | Within Series Adapter, Bulkhd, Hermetic | F-F | Silver | 1.390 | 0.730 | | | | | X | 34 | |
| KA-99-79 | | Within Series Adapter, Bulkhd, Iso Grd | F-F | Silver | 1.280 | 0.430 | 0.630 | 0.440 | | | X | 34 | |
| 129-26-9 | | Within Series Adapter, Bulkhd | F-F | Nickel | 1.280 | 0.812 | | | | | * | 34 | |
| KA-99-114 M06 | | Within Series Adapter, Bulkhd | F-F | Nickel | 1.280 | 0.730 | | | | | X | 34 | |
| 129-29-9 | | Within Series Adapter, Bulkhd | F-F | Nickel | 1.281 | 0.760 | | | | | X | 34 | |
| 2439-5-1 | | W/I Series Adapt, Bulkhd, Hermetic, Keyed | F-F | Nickel | 2.290 | 1.210 | | | | | I | 35 | |
| 2439-5-16 | | W/I Series Adapt, Bulkhd, Hermetic, Keyed | F-F | Nickel | 2.290 | 0.890 | | | | | I | 35 | |
| 2439-5-6 | | W/I Series Adapt, Bulkhd, Hermetic, Keyed | F-F | Nickel | 2.290 | 1.210 | | | | | I | 35 | |
| 2439-6-1 | | W/I Series Adapt, Bulkhd, Hermetic, Keyed | F-F | Nickel | 2.500 | 1.410 | | | | | I | 35 | |
| 2439-5-9 | | W/I Series Adapt, Bulkhd, Hermetic, Keyed | F-F | Nickel | 2.290 | 1.210 | | | | | X | 35 | |
| 2439-6-6 | | W/I Series Adapt, Bulkhd, Hermetic, Keyed | F-F | Nickel | 2.500 | 1.410 | | | | | I | 35 | |
| 2439-6-9 | | W/I Series Adapt, Bulkhd, Hermetic, Keyed | F-F | Nickel | 2.500 | 1.410 | | | | | I | 35 | |
| 129-23-9 | | Within Series Adapter, Panel | F-F | Nickel | 1.280 | 0.500 | 0.090 | | | | * | 36 | |
| 2439-1-1 | | Within Series Adapter, Panel, Keyed | F-F | Nickel | 1.870 | 0.930 | 0.090 | | | | * | N/S | |
| 2439-1-11 | | Within Series Adapter, Panel, Keyed | F-F | Nickel | 1.870 | 0.930 | 0.090 | | | | * | N/S | |
| 2439-1-16 | | Within Series Adapter, Panel, Keyed | F-F | Nickel | 1.870 | 0.930 | 0.090 | | | | * | N/S | |
| 2439-1-6 | | Within Series Adapter, Panel, Keyed | F-F | Nickel | 1.870 | 0.930 | 0.090 | | | | * | N/S | |
| KA-99-74 | | Within Series Adapter, Panel | F-F | Nickel | 1.280 | 0.496 | 0.090 | | | | * | 36 | |
| 129-6 | M55339/50-00001 | Within Series Adapter, Bulkhd, Tee | F-F-F | Silver | 1.280 | 0.710 | 0.440 | 1.140 | | | X | 37 | |
| 129-6 M06 | | Within Series Adapter, Bulkhd, Tee | F-F-F | Nickel | 1.280 | 0.710 | 0.440 | 1.140 | | | X | 37 | |
| 129-4 | M55339/35-00001 | Within Series Adapter, Tee | F-M-F | Silver | 1.280 | 1.110 | 0.630 | 0.890 | | | | 38 | |
| KA-91-16 | | Within Series Adapter, Tee | F-M-F | Silver | 1.280 | 1.110 | 0.640 | 0.890 | | | | 38 | |
| KA-99-125 M06 | | Within Series Adapter, Tee | F-M-F | Nickel | 1.280 | 1.110 | 0.630 | 0.890 | | | | 38 | |
| KA-99-98 | | Within Series Adapter, Tee | M-F-F | Silver | 1.530 | 1.060 | 0.640 | 0.760 | | | | N/S | |
| KA-91-15 | | Within Series Adapter, Angle | M-F | Silver | 1.060 | 1.020 | | | | | | 39 | |
| KA-99-65 | | Within Series Adapter, Angle | M-F | Nickel | 1.040 | 1.060 | | | | | | 39 | |

* Please Contact Customer Service for Additional Information

ACCESSORIES

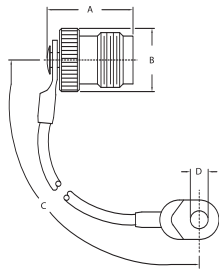

FIGURE 40



FIGURE 41



FIGURE 42



FIGURE 43



FIGURE 44

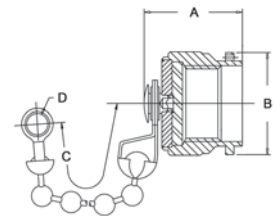

FIGURE 45



FIGURE 46

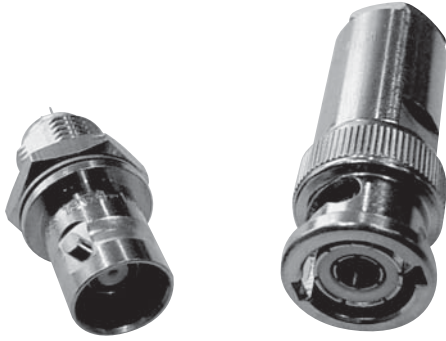

FIGURE 47



FIGURE 48

| Item Number | Military PN | Product Description | Gender | Finish | Dimensions | | | | Cable Group | Cable Procedure | Crimp Die | Mounting Hole | Figure # |
|--------------|----------------|---------------------|--------|--------|------------|-------|-------|-------|-------------|-----------------|-----------|---------------|----------|
| | | | | | A | B | C | D | | | | | |
| 128-17-5 | | Dust Cap & Rope | F | Silver | 0.680 | 0.500 | 7.000 | 0.140 | | | | | 40 |
| 128-26-5 | M39012/25-0118 | Dust Cap & Rope | F | Silver | 0.680 | 0.500 | 4.000 | 0.140 | | | | | 40 |
| 128-32-9 | | Dust Cap & Chain | F | Nickel | 0.680 | 0.500 | 3.250 | 0.280 | | | | | 41 |
| KA-81-02 | M39012/25-0018 | Dust Cap & Chain | F | Silver | 0.680 | 0.500 | 3.000 | 0.280 | | | | | 41 |
| KA-81-07 | | Dust Cap & Chain | F | Silver | 0.690 | 0.500 | 3.730 | 0.440 | | | | | 41 |
| 128-25-5 | M39012/25-0120 | Dust Cap & Rope | M | Silver | 0.710 | 0.650 | 4.000 | 0.140 | | | | | 42 |
| 128-31-5 | | Dust Cap & Chain | M | Silver | 0.500 | 0.630 | 2.250 | 0.140 | | | | | 43 |
| 128-33-5 | | Dust Cap & Chain | M | Silver | 0.718 | 0.650 | 2.500 | | | | | | 44 |
| KA-89-82 | M39012/25-0021 | Dust Cap & Chain | M | Silver | 0.718 | 0.650 | 0.030 | 2.700 | | | | | 44 |
| KA-81-05 | | Dust Cap & Chain | M | Silver | 0.550 | 0.600 | 2.250 | 0.140 | | | | | 45 |
| KA-89-18 | | Dust Cap & Chain | M | Nickel | 0.580 | 0.650 | 0.144 | 2.250 | | | | | 45 |
| KA-81-01 | M39012/25-0020 | Dust Cap & Chain | M | Silver | 0.580 | 0.630 | 2.250 | 0.140 | | | | | 45 |
| 128-3-5 | | Dust Cap & Chain | M | Silver | 0.950 | 0.550 | 2.250 | | | | | | 46 |
| KA-81-04 | | Dust Cap | M | Silver | 0.480 | 0.630 | | | | | | | 47 |
| KA-81-04 M06 | | Dust Cap & Chain | M | Nickel | 0.480 | 0.630 | | | | | | | 47 |
| KA-81-03 | | Shorting Cap | F | Silver | 0.580 | 0.500 | | | | | | | 48 |



- Triaxial version of the popular BNC style connector.
- Miniature size with bayonet coupling.
- 3 Stud design meets MIL-STD-49142.
- Commercial versions also available with 2, 3, or 4 Stud coupling.
- Frequency Range: Up to 500 MHz

SPECIFICATIONS

MATERIAL

| | |
|-------------------------|--|
| Body: | Brass |
| Crimp Sleeves: Alloy | Commercial Bronze |
| Center Contacts: | Brass (Male) Beryllium Copper (Female) |
| Intermediate Contacts: | Beryllium Copper (Male) Beryllium Copper (Female) |
| Insulators: | PTFE |
| Gaskets & Seals: | Silicone Rubber |

FINISHES

| | |
|------------------------|------------------|
| Body: | Silver or Nickel |
| Center Contacts: | Gold |
| Intermediate Contacts: | Silver or Gold |

MECHANICAL

| | |
|------------------|-------------------|
| Life: | 500 Cycles |
| Cable Retention: | 40 Pounds Minimum |

ELECTRICAL

| | |
|--------------------------------|---------------|
| Impedance: | Non-Constant |
| Frequency Range: | DC to 500 MHz |
| Voltage Rating: | 400 Volts RMS |
| Insulation Resistance: | 5000 Megohms |
| Contact Resistance: | |
| Center Contact: | 2.0 Milliohms |
| Intermediate & Outer Contacts: | .5 Milliohms |

ENVIRONMENTAL

| | |
|----------------------|--|
| Temperature Range: | -65° C to +165° C |
| Vibration: | MIL-STD-1344, Method 2005.1, Condition III |
| Shock: | MIL-STD-1344, Method 2004.1, Condition E |
| Corrosion: | MIL-STD-202, Method 101, Condition B |
| Moisture Resistance: | MIL-STD-1344, Method 1002 |

INTERFACE DIMENSIONS

Per MIL-C-49142 or MIL-STD-348 as applicable



TRB SERIES

PLUGS



FIGURE 1



FIGURE 2

ANGLE PLUG

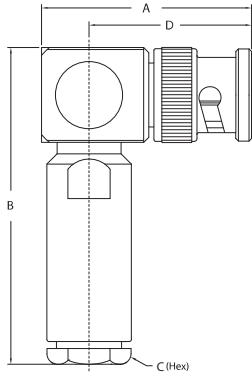

FIGURE 3

ADAPTER

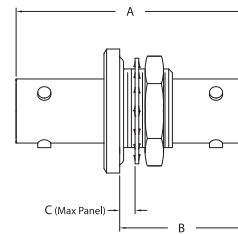

FIGURE 4

ACCESSORIES

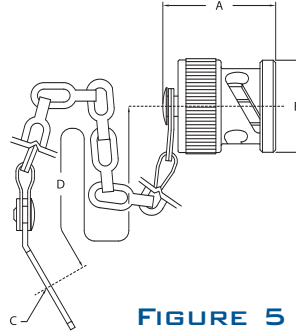

FIGURE 5

| Item Number | Military PN | Product Description | Gender | Finish | Dimensions | | | | Cable Group | Cable Procedure | Crimp Die | Mounting Hole | Figure # |
|-------------|----------------|---------------------------------------|--------|--------|------------|-------|-------|-------|-------------|-----------------|-----------|---------------|----------|
| | | | | | A | B | C | D | | | | | |
| 1965-28-5 | | Plug, Conventional, 2 Stud | M | Silver | 1.650 | 0.560 | | | 28 | 3-392 | | | 1 |
| 1995-12-5 | M49142/03-0004 | Plug, Conventional, 3 Stud | M | Silver | 1.650 | 0.560 | | | 29 | 3-392 | | | 1 |
| 1965-2 | | Plug, Conventional, 2 Stud | M | Silver | 1.460 | 0.560 | | | 46 | CP-1301A | | | 1 |
| 1965-12-9 | | Plug, Conventional, 2 Stud | M | Nickel | 1.500 | 0.560 | | | 47 | CP-1301 | | | 1 |
| 1995-11-5 | M49142/03-0007 | Plug, Conventional, 3 Stud | M | Silver | 1.710 | 0.560 | | | P | 3-446 | | | 1 |
| 1965-5-9 | | Plug, Conventional, 2 Stud | M | Nickel | 1.500 | 0.560 | | | V | CP-1301 | | | 1 |
| 1995-3-9 | | Plug, Conventional, 3 Stud | M | Nickel | 1.500 | 0.560 | | | V | CP-1303 | | | 1 |
| 1995-14-5 | M49142/03-0008 | Plug, Conventional, 3 Stud | M | Silver | 1.520 | 0.560 | | | W | 3-395 | | | 1 |
| 1995-26-102 | | Plug, Crimp, 3 Stud | M | Silver | 2.000 | 0.590 | | | W | 3-400 | KTH-2175 | | 2 |
| 1966-6-5 | | Plug, Conventional, Rt Angle, 2 Stud | M | Silver | 1.400 | 2.100 | 0.440 | 0.900 | Z | CP-1306 | | | 3 |
| 1996-14-5 | | Plug, Conventional, Rt Angle, 3 Stud | M | Silver | 1.400 | 2.100 | 0.440 | 0.900 | Z | CP-1306 | | | 3 |
| 1999-1-4 | | Within Series Adapter, Bulkhd, 3 Stud | F-F | Gold | 1.350 | 0.750 | 0.163 | | | | | X | 4 |
| 1998-2-9 | | Cap & Chain, 3 Stud | M | Nickel | 0.670 | 0.550 | 0.520 | 2.500 | | | | | 5 |
| 1998-6-5 | | Cap & Wire Rope, 3 Stud | M | Nickel | 0.670 | 0.550 | 0.140 | 4.000 | | | | | 5 |

BULKHEAD JACK



FIGURE 6

RECEPTACLES



FIGURE 7



FIGURE 8

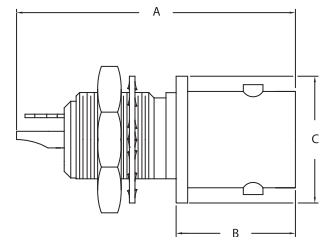

FIGURE 9



FIGURE 10



FIGURE 11

| Item Number | Military PN | Product Description | Gender | Finish | Dimensions | | | | Cable Group | Cable Procedure | Crimp Die | Mounting Hole | Figure # |
|-------------|----------------|---|--------|--------|------------|-------|-------|-------|-------------|-----------------|-----------|---------------|----------|
| | | | | | A | B | C | D | | | | | |
| 1992-9-5 | M49142/05-0004 | Jack, Bulkhd, 3 Stud | F | Silver | 1.750 | 0.810 | 0.630 | | 29 | 3-392 | | X | 6 |
| 1962-2 | | Jack, Bulkhd, 2 Stud | F | Silver | 1.480 | 0.680 | 0.630 | | 46 | CP-1301A | | X | 6 |
| 1962-7-9 | | Jack, Bulkhd, 2 Stud | F | Nickel | 1.530 | 0.680 | 0.630 | | 47 | CP-1301 | | X | 6 |
| 1992-12-102 | | Jack, Bulkhd, 3 Stud | F | Nickel | 1.530 | 0.680 | 0.630 | | W | 3-400 | KTH-2175 | X | N/S |
| 1994-12-9 | | Receptacle, 3 Stud | F | Nickel | 1.140 | 0.500 | | | | SOLDER | | | 7 |
| 1960-1-9 | | Receptacle, Angle, PCB, 2 Stud | F | Silver | 1.760 | 0.520 | 0.440 | | | 3-734 | | | 8 |
| 1964-1-9 | | Receptacle, Bulkhd, Front Mt, 2 Stud | F | Nickel | 1.100 | 0.470 | 0.500 | | | SOLDER | | H | 9 |
| 1994-1-9 | | Receptacle, Bulkhd, Front Mt, 3 Stud | F | Nickel | 1.140 | 0.490 | 0.500 | | | SOLDER | | W | 9 |
| 1967-4-3 | | Receptacle, Panel, 2 Stud | F | Gold | 0.622 | 0.620 | 0.500 | | | SOLDER | | | 10 |
| 1964-3-9 | | Receptacle, Bulkhd, Rear Mt, 2 Stud | F | Silver | 1.340 | 0.820 | 0.630 | 0.680 | | SOLDER | | X | 11 |
| 1994-3-5 | M49142/04-0004 | Receptacle, Bulkhd, Rear Mt, 3 Stud | F | Silver | 1.100 | 0.820 | 0.630 | 0.690 | | SOLDER | | X | 11 |
| 2724-2-5 | | Receptacle, Bulkhd, Rear Mt, Hermetic, 3 Stud | F | Silver | 1.240 | 0.831 | 0.625 | 0.687 | | SOLDER | | X | 11 |
| 1994-4-5 | M49142/04-0005 | Receptacle, Bulkhd, Rear Mt, Hermetic, 3 Stud | F | Silver | 1.240 | 1.090 | 0.630 | 0.690 | | SOLDER | | X | 11 |
| 2954-1-5 | | Receptacle, Bulkhd, Rear Mt, Hermetic, 3 Stud | F | Silver | 1.240 | 0.831 | 0.625 | 0.687 | | SOLDER | | X | 11 |
| 1998-8-5 | | Receptacle, Bulkhd, Front Mt, Dummy, 3 Stud | F | Silver | 0.910 | 0.500 | | | | SOLDER | | H | N/S |

TRT SERIES



- Triaxial version of the popular TNC style connector.
- Miniature size with threaded coupling.
- Designed to meet MIL-STD-49142.
- Feature weatherproof taper grip construction, utilizing metal to metal cable clamping.

SPECIFICATIONS

MATERIAL

| | |
|-------------------------------|-------------------------|
| Body: | Brass |
| Crimp Sleeves: | Commercial Bronze Alloy |
| Male Center Contacts: | Brass |
| Female Center Contacts: | Beryllium Copper |
| Male Intermediate Contacts: | Beryllium Copper |
| Female Intermediate Contacts: | Beryllium Copper |
| Insulators: | PTFE |
| Gaskets & Seals: | Silicone Rubber |

FINISHES

| | |
|------------------------|------------------|
| Body: | Silver or Nickel |
| Center Contacts: | Gold |
| Intermediate Contacts: | Silver or Gold |

MECHANICAL

| | |
|------------------|-------------------|
| Life: | 500 Cycles |
| Cable Retention: | 40 Pounds Minimum |

ELECTRICAL

| | |
|--------------------------------|---------------|
| Impedance: | Non-Constant |
| Frequency Range: | DC to 500 MHz |
| Voltage Rating: | 400 Volts RMS |
| Insulation Resistance: | 5000 Megohms |
| Contact Resistance: | |
| Center Contact: | 2.0 Milliohms |
| Intermediate & Outer Contacts: | .5 Milliohms |

ENVIRONMENTAL

| | |
|----------------------|---|
| Temperature Range: | -65° C to +165° C |
| Vibration: | MIL-STD-1344, Method 2005.1, Condition III |
| Shock: | MIL-STD-1344, Method 2004.1, Condition E |
| Corrosion: | MIL-STD-202, Method 101, Condition B |
| Moisture Resistance: | MIL-STD-1344, Method 1002 |

INTERFACE DIMENSIONS

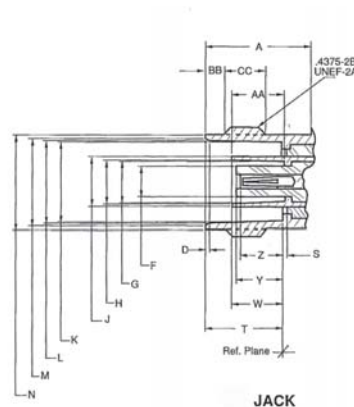
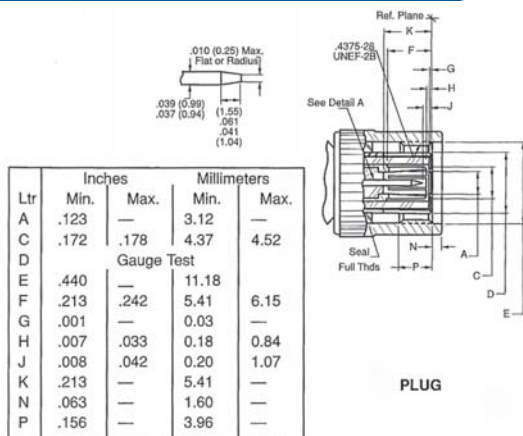

PLUGS



FIGURE 1



FIGURE 2

BULKHEAD & PANEL JACKS



FIGURE 3

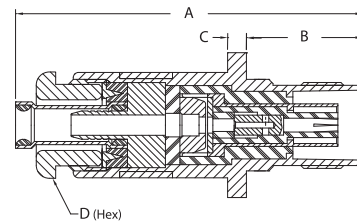

FIGURE 4

BULKHEAD RECEPTACLES

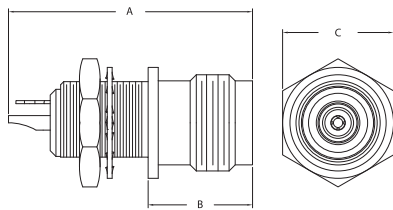

FIGURE 5



FIGURE 6

| Item Number | Military PN | Product Description | Gender | Finish | Dimensions | | | | Cable Group | Cable Procedure | Crimp Die | Mounting Hole | Figure # |
|-------------|----------------|---------------------------------------|--------|--------|------------|-------|-------|-------|-------------|-----------------|-----------|---------------|----------|
| | | | | | A | B | C | D | | | | | |
| 1945-13-5 | M49142/08-0002 | Plug, Conventional | M | Silver | 1.490 | 0.640 | | | V | 3-391 | | | 1 |
| 1945-19-102 | | Plug, Crimp | M | Silver | 2.000 | 0.650 | | | W | 3-400 | KTH-2175 | | 2 |
| 1945-35-9 | | Plug, Crimp | M | Nickel | 1.640 | 0.640 | | | 44 | 3-645 | KTH-2120 | | 2 |
| 1942-7-5 | M49142/09-0006 | Jack, Bulkhd | F | Silver | 1.750 | 0.810 | 0.630 | 0.440 | W | 3-395 | | X | 3 |
| 1941-6-9 | | Jack, Panel | F | Nickel | 1.640 | 0.550 | 0.090 | 0.440 | 44 | 3-645 | KTH-2120 | | 4 |
| 1944-1-9 | | Receptacle, Bulkhd, Front Mt | F | Nickel | 1.100 | 0.470 | 0.500 | | | SOLDER | | H | 5 |
| 1944-3-5 | M49142/10-0001 | Receptacle, Bulkhd, Rear Mt | F | Silver | 1.100 | 0.820 | 0.690 | | | SOLDER | | X | 6 |
| 1947-5-9 | | Receptacle, Bulkhd, Rear Mt | F | Nickel | 1.390 | 0.630 | | | | SOLDER | | X | 6 |
| 1944-8-5 | M49142/10-0002 | Receptacle, Bulkhd, Rear Mt, Hermetic | F | Silver | 1.240 | 0.690 | 0.264 | | | SOLDER | | X | 6 |

10 KV SERIES

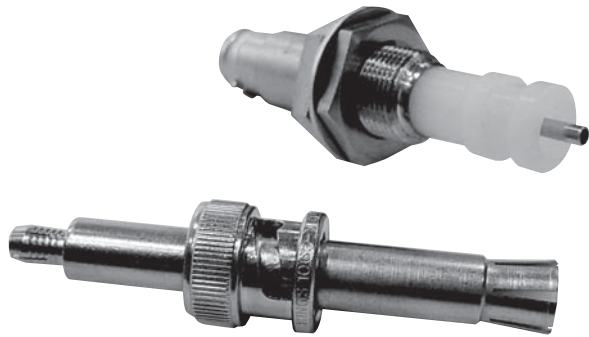

- Non-constant impedance.
- Ideally suited for pulse applications.
- Durable Brass bodies with Nickel plating.
- Feature polyethylene high density insulators.
- Operating voltage rating of 10 KV DC.

SPECIFICATIONS

MATERIAL

| | |
|-------------------------|-------------------------|
| Body: | Brass |
| Crimp Sleeves: | Commercial Bronze Alloy |
| Male Center Contacts: | Brass |
| Female Center Contacts: | Beryllium Copper |
| Outer Contacts: | Beryllium Copper |
| Insulators: | Polyethylene |
| Gaskets & Seals: | Silicone Rubber |

FINISHES

| | |
|------------------|--------|
| Body: | Nickel |
| Center Contacts: | Gold |

MECHANICAL

| | |
|---------|-------------------------|
| Mating: | 2 Stud Bayonet Coupling |
|---------|-------------------------|

ELECTRICAL

| | |
|------------------------|---------------------------------------|
| Impedance: | Non-Constant |
| Voltage Rating: | Operating: 10 KV DC Test: 15 KV DC |
| Insulation Resistance: | 10 ⁶ Megaohms |

ENVIRONMENTAL

| | |
|-------------------------|---|
| Temperature Range: | -55° C to +85° C |
| Polyethylene Insulators | -65° C to +165° C |
| PTFE Insulators | |
| Vibration: | MIL-STD-202, Method 204, Condition A |
| Shock: | MIL-STD-202, Method 213, Condition I |
| Corrosion: | MIL-STD-202, Method 101, Condition B |

INTERFACE DIMENSIONS

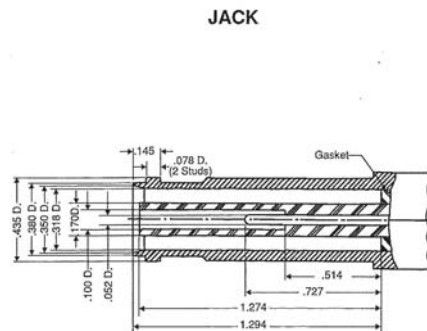
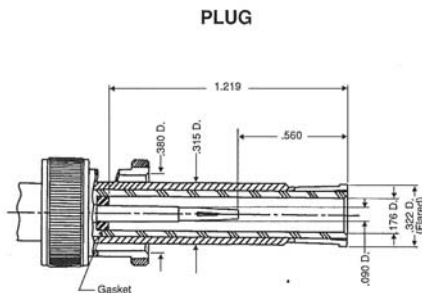

PLUG - K-GRIP, JR.

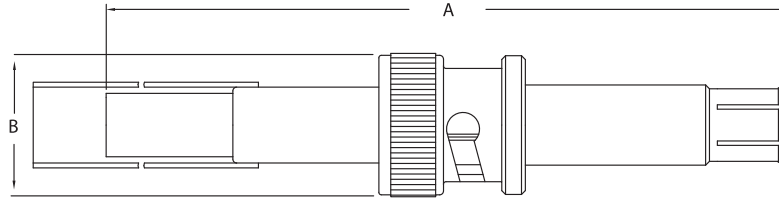

FIGURE 1

BULKHEAD RECEPTACLE

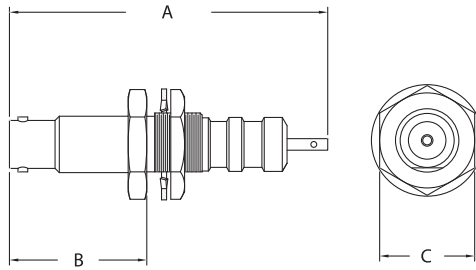

FIGURE 2

ADAPTER - WITHIN SERIES

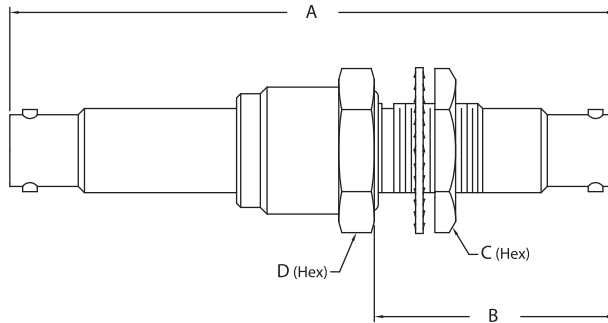

FIGURE 3

| Item Number | Military PN | Product Description | Gender | Finish | Dimensions | | | | Cable Group | Cable Procedure | Crimp Die | Mounting Hole | Figure # |
|-------------|-------------|-------------------------------|--------|--------|------------|-------|-------|-------|-------------|-----------------|-----------|---------------|----------|
| | | | | | A | B | C | D | | | | | |
| 1065-1 QD | | Plug, Crimp | M | Nickel | 2.710 | 0.560 | | | D | 3-7-1 | KTH-2001 | | 1 |
| 1065-2 | | Plug, Crimp | M | Nickel | 2.710 | 0.560 | | | 40 | CP-419 | KTH-2001 | | 1 |
| 1064-1 QD | | Receptacle, Bulkhd, Front Mt | F | Nickel | 2.500 | 1.080 | 0.750 | 0.750 | | SOLDER | | X | 2 |
| 1069-1 | | Within Series Adapter, Bulkhd | F-F | Nickel | 3.180 | 1.270 | 0.750 | 0.750 | | | | X | 3 |

20 KV SERIES



- Non-constant impedance.
- Ideally suited for pulse applications.
- Durable Brass bodies with Nickel plating.
- Feature polyethylene high density insulators.
- Operating voltage rating of 20 KV DC.

SPECIFICATIONS

MATERIAL

| | |
|-------------------------|-------------------------|
| Body: | Brass |
| Crimp Sleeves: | Commercial Bronze Alloy |
| Male Center Contacts: | Brass |
| Female Center Contacts: | Beryllium Copper |
| Outer Contacts: | Brass |
| Insulators: | Polyethylene |
| Gaskets & Seals: | Silicone Rubber |

FINISHES

| | |
|------------------|--------|
| Body: | Nickel |
| Center Contacts: | Gold |

MECHANICAL

| | |
|---------|-------------------------|
| Mating: | 2 Stud Bayonet Coupling |
|---------|-------------------------|

ELECTRICAL

| | |
|------------------------|---------------------------------------|
| Impedance: | Non-Constant |
| Voltage Rating: | Operating: 20 KV DC Test: 30 KV DC |
| Insulation Resistance: | 10 ⁶ Megaohms |

ENVIRONMENTAL

| | |
|-------------------------|--------------------------------------|
| Temperature Range: | |
| Polyethylene Insulators | -55° C to +85° C |
| Vibration: | MIL-STD-202, Method 204, Condition A |
| Shock: | MIL-STD-202, Method 213, Condition I |
| Corrosion: | MIL-STD-202, Method 101, Condition B |

INTERFACE DIMENSIONS

PLUG

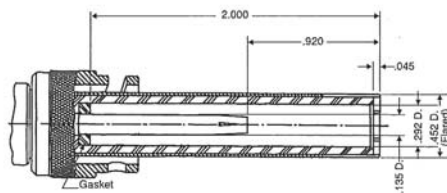

JACK

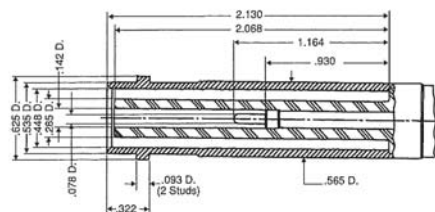

PLUG - K-GRIP, JR.



FIGURE 1

BULKHEAD RECEPTACLE



FIGURE 2

| Item Number | Military PN | Product Description | Gender | Finish | Dimensions | | | | Cable Group | Cable Procedure | Crimp Die | Mounting Hole | Figure # |
|-------------|-------------|------------------------------|--------|--------|------------|-------|---|---|-------------|-----------------|-----------|---------------|----------|
| | | | | | A | B | C | D | | | | | |
| 1765-1 | | Plug, Crimp | M | | 4.520 | 0.750 | | | M | 3-7-2 | KTH-1078 | | 1 |
| 1764-2 | | Receptacle, Bulkhd, Front Mt | F | | 4.390 | 1.390 | | | | SOLDER | | Y | 2 |
| 1764-1 | | Receptacle, Bulkhd, Front Mt | F | | 3.910 | 1.390 | | | | SOLDER | | I | 2 |

HN SERIES



- 50 Ohm Nominal Impedance.
- Standard size connector with threaded coupling.
- High-voltage version of the Type N connector.
- Overlapping dielectric interface with weatherproof features.
- Frequency Range: Up to 4 GHz

SPECIFICATIONS

MATERIAL

| | |
|-------------------------|-------------------------|
| Body: | Brass |
| Crimp Sleeves: | Commercial Bronze Alloy |
| Male Center Contacts: | Brass |
| Female Center Contacts: | Beryllium Copper |
| Male Outer Contacts: | Brass |
| Insulators: | PTFE or Rexolite® |
| Gaskets & Seals: | Silicone Rubber |

FINISHES

| | |
|------------------|------------------|
| Body: | Silver or Nickel |
| Center Contacts: | Gold or Silver |

ELECTRICAL

| | |
|------------------------|----------------|
| Impedance: | 50 Ohms |
| Frequency Range: | DC to 4 GHz |
| Voltage Rating: | 1500 Volts RMS |
| Insulation Resistance: | 5000 Megohms |

MECHANICAL

| | |
|---------|----------------------------|
| Mating: | 3/4 - 20 Threaded Coupling |
|---------|----------------------------|

ENVIRONMENTAL

| | |
|--------------------|---|
| Temperature Range: | PTFE Insulator: -65° C to +165° C Rexolite Insulator: -55° C to +85° C |
| Corrosion: | MIL-STD-202, Method 101, Condition B |

INTERFACE DIMENSIONS

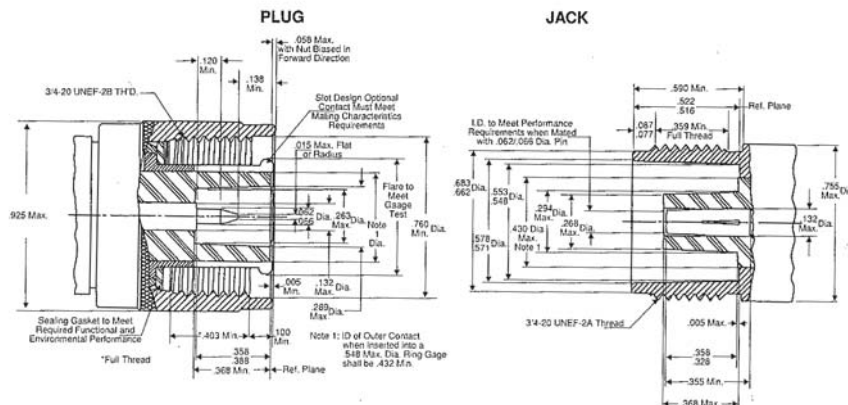

PLUG - K-GRIP, JR.

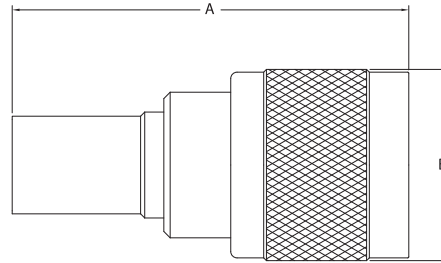

FIGURE 1

ANGLE PLUG - K-GRIP, JR.

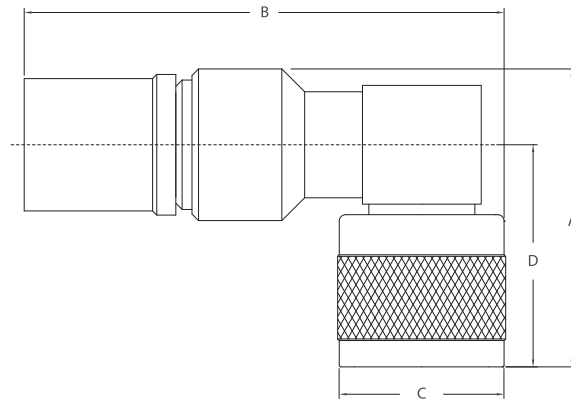

FIGURE 2

| Item Number | Military PN | Product Description | Gender | Finish | A | Dimensions B | C | D | Cable Group | Cable Procedure | Crimp Die | Mounting Hole | Figure # |
|-------------|-------------|--------------------------------------|--------|--------|-------|--------------|-------|-------|-------------|-----------------|-----------|---------------|----------|
| KH-59-05 | | Plug, Conventional | M | Silver | 1.610 | 0.880 | | | G1 | CP-1021.3 | | | N/S |
| KH-59-72 | | Plug, Conventional | M | Silver | 1.625 | 0.500 | | | DE | CP-1004 | | | N/S |
| UG-59 E/U | | Plug, Conventional | M | Silver | 2.218 | 0.875 | | | MN | 60D-5 | | | N/S |
| KH-59-78 | | Plug, Conventional/Crimp | M | Silver | 2.230 | 0.450 | | | N1 | CP-239A | KTH-2004 | | N/S |
| 845-10-9 | | Plug, Crimp, Weatherproof | M | Nickel | 1.930 | 0.890 | | | 19 | 3-546-2 | KTH-2213 | | 1 |
| 845-13-9 | | Plug, Crimp, Weatherproof | M | Nickel | 1.830 | 0.890 | | | 18 | 3-546-4 | KTH-2212 | | 1 |
| 845-9-9 | | Plug, Crimp, Weatherproof | M | Nickel | 1.890 | 0.890 | | | 20 | 3-546-2 | KTH-2229 | | 1 |
| KH-59-63 | | Plug, Crimp, Weatherproof | M | Nickel | 1.930 | 0.880 | | | M1 | CP-5403 | KTH-1078 | | 1 |
| KH-59-65 | | Plug, Crimp, Weatherproof | M | Nickel | 1.930 | 0.880 | | | N1 | CP-5403 | KTH-1079 | | 1 |
| KH-59-26 | | Plugs, Rt Angle, Conventional | M | Silver | 1.560 | 2.370 | 0.750 | 1.190 | MN | 60D-5 | | | N/S |
| KH-59-84 | | Plugs, Rt Angle, Conventional | M | Silver | 1.540 | 2.380 | 0.750 | 1.190 | N3 | CP-1031 | | | N/S |
| 846-5-9 | | Plugs, Rt Angle, Crimp, Weatherproof | M | Nickel | 1.510 | 2.250 | 0.880 | 1.190 | 18 | 3-546-7 | KTH-2212 | | 2 |
| 846-7-9 | | Plugs, Rt Angle, Crimp, Weatherproof | M | Nickel | 1.550 | 2.310 | 0.880 | 1.190 | 20 | 3-546-2 | KTH-2229 | | 2 |
| KH-59-24 | | Plugs, Rt Angle, Crimp | M | Silver | 1.500 | 2.810 | 0.750 | 1.180 | N1 | CP-208A | KTH-2004 | | N/S |
| KH-59-64 | | Plugs, Rt Angle, Crimp, Weatherproof | M | Nickel | 1.500 | 2.400 | 0.880 | 1.190 | M1 | CP-5403 | KTH-1078 | | 2 |
| KH-59-66 | | Plugs, Rt Angle, Crimp, Weatherproof | M | Nickel | 1.500 | 2.400 | 0.690 | 1.190 | 2 | CP-5403 | KTH-1079 | | 2 |

ADAPTERS



FIGURE 3



FIGURE 4

JACKS, RECEPTACLES, & ACCESSORIES

| Item Number | Military PN | Product Description | Gender | Finish | Dimensions | | | | Cable Group | Cable Procedure | Crimp Die | Mounting Hole | Figure # |
|--------------|-------------|---|--------|--------|------------|-------|-------|-------|-------------|-----------------|-----------|---------------|----------|
| | | | | | A | B | C | D | | | | | |
| KH-99-10 | | Within Series Adapter | M-M | Silver | 1.850 | 0.880 | | | | | | | 3 |
| 849-5-9 | | Within Series Adapter, Bulkhead, Hermetic | F-F | Nickel | 1.930 | 1.060 | 1.060 | 1.060 | | | | Z | 4 |
| KH-39-11 | | Jack, Conventional/Crimp | F | Silver | 2.050 | 0.750 | | | M1 | CP-208A | KTH-2003 | | N/S |
| KH-39-12 | | Jack, Conventional/Crimp | F | Silver | 2.040 | 0.750 | | | N1 | CP-208A | KTH-2004 | | N/S |
| KH-39-25 M06 | | Jack, Crimp, Weatherproof | F | Nickel | 1.910 | 0.750 | | | 12 | CP-5403 | KTH-2127 | | N/S |
| KH-79-15 | | Receptacle, Bulkhead | F | Nickel | 1.720 | 1.060 | 1.130 | | | SOLDER | | | N/S |
| UG-496/U | | Receptacle, Panel | F | Silver | 1.530 | 1.180 | | | | SOLDER | | | N/S |
| 848-3-5 | | Dust Cap & Chain | M | Silver | 0.560 | 0.875 | 3.250 | | | | | | N/S |



- 5 KV voltage rating.
- Non-constant impedance.
- Quick connect & disconnect bayonet coupling.
- Originally designed for high-voltage BNC applications.
- Meet the requirements of MIL-PRF-39012.

SPECIFICATIONS

MATERIAL

| | |
|-------------------------|-------------------------|
| Body: | Brass |
| Crimp Sleeves: | Commercial Bronze Alloy |
| Male Center Contacts: | Brass |
| Female Center Contacts: | Beryllium Copper |
| Outer Contacts: | Brass |
| Insulators: | PTFE |
| Gaskets & Seals: | Silicone Rubber |

FINISHES

| | |
|------------------|--------|
| Body: | Silver |
| Center Contacts: | Gold |

ELECTRICAL

| | |
|------------------------|---|
| Impedance: | Non-Constant |
| Voltage Rating: | Operating: 3500 VRMS Test: 5000 VRMS |
| Insulation Resistance: | 5000 Megohms |

MECHANICAL

| | |
|---------|-------------------------|
| Mating: | 2 Stud Bayonet Coupling |
|---------|-------------------------|

ENVIRONMENTAL

| | |
|--------------------|---|
| Temperature Range: | -65° C to +165° C |
| Vibration: | MIL-STD-202, Method 204, Condition A |
| Shock: | MIL-STD-202, Method 213, Condition I |
| Corrosion: | MIL-STD-202, Method 101, Condition B |

INTERFACE DIMENSIONS

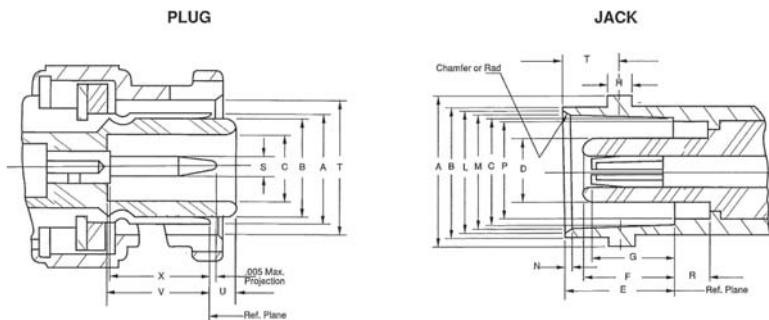

Plug

| Dim | Inches (mm) | |
|-----|-------------|-------------|
| | Minimum | Maximum |
| Ltr | | |
| A | Gauge Test | |
| B | .278 (7.06) | .282 (7.16) |
| C | .190 (4.83) | .194 (4.93) |
| S | .052 (1.32) | .054 (1.37) |
| T | .385 (9.78) | .390 (9.91) |
| U | | .086 (2.18) |
| V | .302 (7.67) | |
| X | .300 (7.62) | |
| Z | .045 (1.14) | .049 (1.24) |

Jack

| Dim | Inches (mm) | |
|-----|--------------|--------------|
| | Minimum | Maximum |
| Ltr | | |
| A | .432 (10.97) | .436 (11.07) |
| B | .378 (9.60) | .382 (9.70) |
| C | .319 (8.10) | .321 (8.15) |
| D | | .186 (4.72) |
| E | .327 (8.31) | .335 (8.51) |
| F | .289 (7.34) | .311 (7.90) |
| G | .253 (6.43) | .280 (7.11) |
| H | .075 (1.91) | .081 (2.06) |
| L | .346 (8.79) | .356 (9.04) |
| M | .327 (8.31) | .333 (8.46) |
| N | .015 (0.38) | .030 (0.76) |
| P | .284 (7.21) | .290 (7.37) |
| R | .086 (2.18) | |
| T | .165 (4.19) | .169 (4.29) |

PLUG - CONVENTIONAL



FIGURE 1

PLUG - K-GRIP, JR.



FIGURE 2

ADAPTERS - WITHIN SERIES



FIGURE 3



FIGURE 4

| Item Number | Military PN | Product Description | Gender | Finish | Dimensions | | | | Cable Group | Cable Procedure | Crimp Die | Mounting Hole | Figure # |
|-------------|-------------|--------------------------------------|--------|--------|------------|-------|---|---|-------------|-----------------|-----------|---------------|----------|
| | | | | | A | B | C | D | | | | | |
| 1685-2-5 | | Plug, Conventional | M | Silver | 1.560 | 0.560 | | | G1 | CP-1002 | | | 1 |
| KV-59-04 | | Plug, Conventional | M | Silver | 1.560 | 0.560 | | | DE | CP-1002 | | | 1 |
| KV-59-26 | | Plug, Conventional | M | Nickel | 1.560 | 0.560 | | | G1 | CP-1002 | | | 1 |
| KV-59-70 | | Plug, Conventional | M | Nickel | 1.540 | 0.560 | | | B1 | CP-1002 | | | 1 |
| KV-59-56 | | Plug, Conventional, Polarized | M | Silver | 1.630 | 0.560 | | | DE | CP-1002 | | | 1 |
| KV-59-23 | | Plug, Crimp | M | Nickel | 1.500 | 0.560 | | | G1 | CP-417 | KTH-2002 | | 2 |
| KV-59-37 | | Plug, Crimp | M | Nickel | 1.500 | 0.560 | | | D | CP-417 | KTH-2001 | | 2 |
| KV-99-45 | | W/I Series, Bkhd, Polarized to Stand | F-F | Silver | 1.360 | 0.690 | | | | | | X | 3 |
| KV-99-46 | | Within Series Adapter, Tee | F-M-F | Nickel | 1.280 | 1.140 | | | | | | | 4 |

BULKHEAD RECEPTACLE

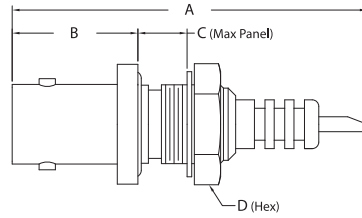

FIGURE 5

PANEL RECEPTACLE



FIGURE 6

RECEPTACLE - OTHER



FIGURE 7

| Item Number | Military PN | Product Description | Gender | Finish | Dimensions | | | | Cable Group | Cable Procedure | Crimp Die | Mounting Hole | Figure # |
|-------------|-------------|------------------------------|--------|--------|------------|-------|-------|-------|-------------|-----------------|-----------|---------------|----------|
| | | | | | A | B | C | D | | | | | |
| KV-79-11 | | Receptacle, Bulkhd, Front Mt | F | Silver | 1.420 | 0.470 | 0.112 | | | SOLDER | | | 5 |
| KV-79-15 | | Receptacle, Bulkhd, Front Mt | F | Nickel | 1.690 | 0.590 | 0.234 | | | SOLDER | | AA | 5 |
| KV-79-12 | | Receptacle, Panel | F | Nickel | 1.430 | 0.630 | 0.085 | 0.690 | | SOLDER | | | 6 |
| KV-79-21 | | Receptacle | M | Nickel | 1.190 | 0.060 | | | | SOLDER | | | 7 |

SHV SERIES



- 5 KV voltage rating.
- Non-constant impedance.
- Quick connect & disconnect bayonet coupling design.
- Outer contact ground connection is maintained through the center contact mating cycle.
- Recessed center contacts prevent shock hazards while unmated.

SPECIFICATIONS

MATERIAL

| | |
|-------------------------|-------------------------|
| Body: | Brass |
| Crimp Sleeves: | Commercial Bronze Alloy |
| Male Center Contacts: | Brass |
| Female Center Contacts: | Beryllium Copper |
| Outer Contacts: | Beryllium Copper |
| Insulators: | PTFE or Rexolite® |
| Gaskets & Seals: | Silicone Rubber |

FINISHES

| | |
|------------------|--------|
| Body: | Nickel |
| Center Contacts: | Gold |

ELECTRICAL

| | |
|------------------------|---|
| Impedance: | Non-Constant |
| Voltage Rating: | Operating: 3500 VRMS Test: 5000 VRMS |
| Insulation Resistance: | 10 ⁶ Megaohms |

MECHANICAL

Mating: 2 Stud Bayonet Coupling

ENVIRONMENTAL

| | |
|--------------------|--|
| Temperature Range: | PTFE -65° C to +165° C Rexolite® -55° C to +85° C |
| Vibration: | MIL-STD-202, Method 204, Condition A MIL-STD-202, Method 213, Condition I |
| Shock: | MIL-STD-202, Method 101, Condition B |
| Corrosion: | |

INTERFACE DIMENSIONS

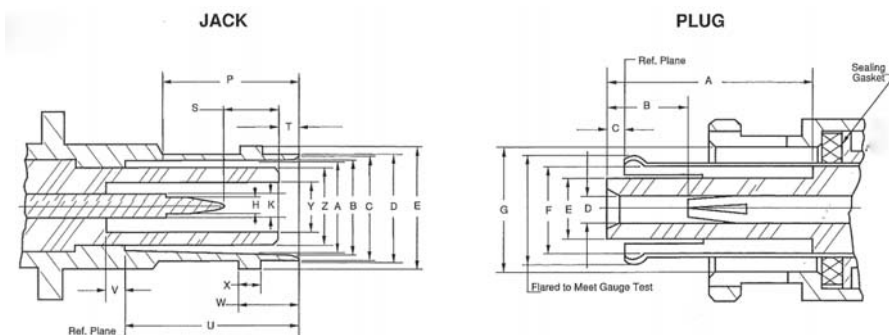

Jack

| Dim | Inches | | Millimeters | |
|-----|--------|------|-------------|-------|
| | Min | Max | Min | Max |
| A | .319 | .321 | 8.10 | 8.15 |
| B | .328 | .333 | 8.33 | 8.46 |
| C | .347 | .357 | 8.81 | 9.07 |
| D | .378 | .382 | 9.60 | 9.70 |
| E | .432 | .436 | 10.97 | 11.07 |
| H | .052 | .054 | 1.32 | 1.37 |
| K | .081 | .083 | 2.06 | 2.11 |
| P | .427 | | 10.85 | |
| S | .188 | .208 | 4.78 | 5.28 |
| T | .061 | .078 | 1.55 | 1.98 |
| U | .626 | .630 | 15.90 | 16.00 |
| V | .064 | .086 | 1.63 | 2.18 |
| W | .204 | .208 | 5.18 | 5.28 |
| X | .075 | .081 | 1.90 | 2.06 |
| Y | .190 | .196 | 4.83 | 4.98 |
| Z | | .280 | | 6.80 |

Plug

| Dim | Inches | | Millimeters | |
|-----|--------|------|-------------|-------|
| | Min | Max | Min | Max |
| A | .628 | .632 | 15.95 | 16.05 |
| B | .238 | .262 | 6.05 | 6.65 |
| C | .046 | .064 | 1.17 | 1.63 |
| D | .082 | | 2.08 | |
| E | .180 | .186 | 4.57 | 4.72 |
| F | .264 | | 6.71 | |
| G | .385 | .390 | 9.78 | 9.91 |

BULKHEAD RECEPTACLES



FIGURE 1



FIGURE 2

ADAPTERS - WITHIN SERIES

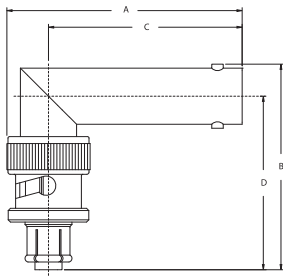

FIGURE 3

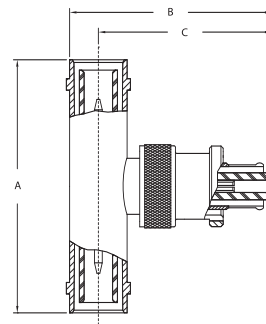

FIGURE 4



FIGURE 5



FIGURE 6

| Item Number | Military PN | Product Description | Gender | Finish | Dimensions | | | | Cable Group | Cable Procedure | Crimp Die | Mounting Hole | Figure # |
|---------------|-------------|--|--------|--------|------------|-------|-------|-------|-------------|-----------------|-----------|---------------|----------|
| | | | | | A | B | C | D | | | | | |
| 1704-1 QD | | Receptacle, Bulkhd, Front Mt, PTFE Insl | F | Nickel | 1.790 | 0.670 | 0.182 | 0.500 | | SOLDER | | H | 1 |
| 1704-3-9 | | Receptacle, Bulkhd, Front Mt | F | Nickel | 1.780 | 0.670 | 0.182 | 0.500 | | SOLDER | | | 1 |
| 1704-1-11 M06 | | Recept, Bulkhd, Front Mt, Rexolite Insl | F | Nickel | 1.780 | 0.670 | 0.182 | 0.500 | | SOLDER | | H | 1 |
| 1704-2 | | Receptacle, Bulkhd, Rear Mt | F | Nickel | 1.790 | 0.810 | 0.235 | 0.630 | | SOLDER | | X | 2 |
| 1709-12 M06 | | Within Series Adapter, Rt Angle | F-M | Nickel | 1.590 | 1.390 | 1.310 | 1.170 | | | | | 3 |
| 1709-3 | | Within Series Adapter, Tee | M-F-M | Nickel | 1.710 | 1.370 | 1.170 | | | | | | 4 |
| 1709-5 | | Within Series Adapter | F-F | Nickel | 1.990 | 0.440 | | | | | | | 5 |
| 1709-1 | | Within Series Adapter, Bulkhd, PTFE Insl | M-M | Nickel | 1.990 | 0.950 | 0.690 | 0.630 | | | | X | 6 |
| 1709-1-11 | | Within Series Adapter, Bulkhd, Rexolite Insl | M-M | Nickel | 1.990 | 0.950 | 0.690 | 0.630 | | | | X | 6 |
| 1709-2 | | Within Series Adapter, Bulkhd, Hermetic | F-F | Nickel | 2.250 | 1.150 | 0.690 | 0.630 | | | | X | 6 |

SHV SERIES

PLUGS - K-GRIP, JR.

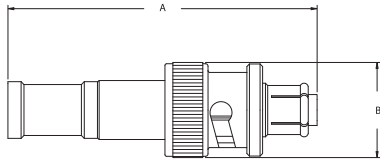

FIGURE 7

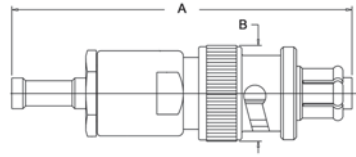

FIGURE 8

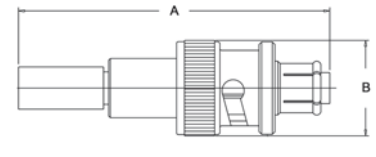

FIGURE 9

PLUG - CONVENTIONAL



FIGURE 10

BULKHEAD JACK - K-GRIP, JR.

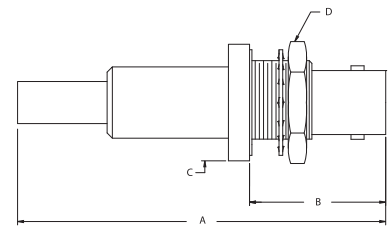

FIGURE 11

PANEL RECEPTACLE

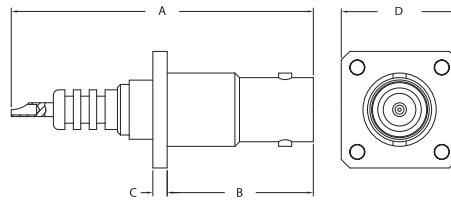

FIGURE 12

| Item Number | Military PN | Product Description | Gender | Finish | A | Dimensions B | C | D | Cable Group | Cable Procedure | Crimp Die | Mounting Hole | Figure # |
|-------------|-------------|---|--------|--------|-------|--------------|-------|-------|-------------|-----------------|-----------|---------------|----------|
| 1705-1 | | Plug, Weatherproof Crimp, PTFE Insl | M | Nickel | 1.830 | 0.560 | | | G1 | CP-441 | KTH-2062 | | 7 |
| 1705-2 | | Plug, Weatherproof Crimp, PTFE Insl | M | Nickel | 1.750 | 0.560 | | | D | CP-441 | KTH-2061 | | 7 |
| 1705-2-1 | | Plug, Weatherproof Crimp, Rexolite Insl | M | Nickel | 1.730 | 0.560 | | | D | CP-441 | KTH-2061 | | 7 |
| 1705-21-9 | | Plug, Weatherproof Crimp, 6KV | M | Nickel | 1.710 | 0.560 | | | G1 | CP-441 | KTH-2062 | | 7 |
| 1705-4 | | Plug, Weatherproof Crimp | M | Nickel | 2.140 | 0.630 | | | N1 | CP-457 | KTH-1079 | | 7 |
| 1705-3 | | Plug, Weatherproof Crimp | M | Nickel | 2.010 | 0.560 | | | B1 | CP-447 | KTH-2071 | | 8 |
| 1705-16 M06 | | Plug, Crimp, PTFE Insl | M | Nickel | 1.790 | 0.560 | | | 40 | CP-441 | KTH-2001 | | 9 |
| 1705-16-11 | | Plug, Crimp, Rexolite Insl | M | Nickel | 1.770 | 0.560 | | | 40 | CP-441 | KTH-2001 | | 9 |
| 1705-14 | | Plug, Conventional | M | Nickel | 1.810 | 0.560 | | | G1 | CP-1001.3 | | | 10 |
| 1702-1 | | Jack, Bulkhd, Rear Mt | F | Nickel | 2.200 | 0.810 | 0.690 | 0.630 | G1 | CP-441 | KTH-2062 | X | 11 |
| 1702-2 | | Jack, Bulkhd, Rear Mt | F | Nickel | 2.200 | 0.810 | 0.690 | 0.630 | D | CP-441 | KTH-2061 | X | 11 |
| 1702-4-11 | | Jack, Bulkhd, Rear Mt | F | Nickel | 2.200 | 0.810 | 0.690 | 0.630 | 40 | CP-441 | KTH-2001 | X | 11 |
| 1707-1 | | Receptacle, Panel | M | Nickel | 1.790 | 0.870 | 0.090 | 0.690 | | SOLDER | | | 12 |



- 75 Ohm performance suitable for Analog, Serial Digital and HDTV applications.
- Meets or exceeds SMPTE 292 requirements.
- Several configurations available to fit a variety of cables.
- Simple, full crimp design for easy field installation.
- Quick connect and disconnect with Bayonet coupling.
- A Mini BNC version is also available - contact Customer Service for additional information.

SPECIFICATIONS

MATERIAL

Body: Brass
 Outer Contact: Beryllium Copper
 Insulator: PTFE
 K-Grip Sleeve: Commercial Bronze

FINISHES

Body: Nickel
 Contacts: Gold

ELECTRICAL

Impedance: 75 Ohms
 Voltage Rating: 500 Volts RMS
 Return Loss: Up to 1 GHz, -36 dB min
 Up to 2 GHz, -25 dB min
 Up to 3 GHz, -23 dB min
 Up to 4 GHz, -20 dB min

MECHANICAL

Life: 500 cycles minimum
 Cable Retention: 10 lbs to 40 lbs, Depending on Cable Size
 Engagement Force: 2.5 lbs maximum, Torque
 3.0 lbs maximum, Longitudinal

ENVIRONMENTAL

Temperature: -65°C to +165°C
 Moisture: 0 to 95%
 MIL-STD-202 Method 106
 Corrosion: MIL-STD-202 Method 101,
 Test Condition B
 Flammability: UL 94-VO Rated
 Vibration: MIL-STD-202 Method 204,
 Test Condition B

INTERFACE DIMENSIONS

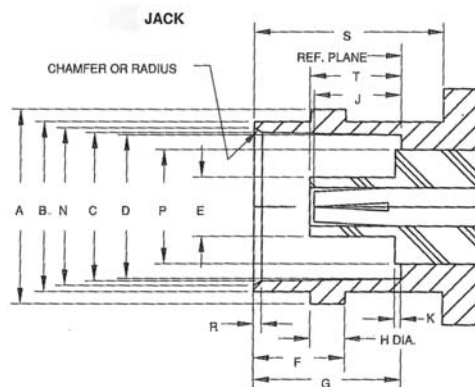
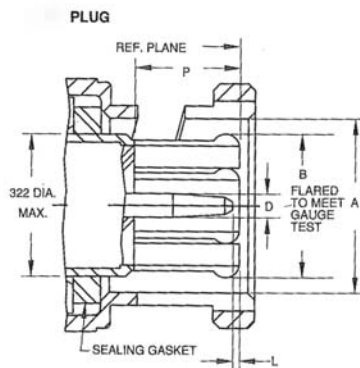

| Dim. Ltr. | Min. | Max. | Dim. Ltr. | Min. | Max. |
|-----------|--------------|--------------|-----------|--------------|-------------|
| A | .432 (10.97) | .436 (11.07) | H | .075 (1.91) | .081 (2.06) |
| B | .378 (9.60) | .382 (9.70) | J | .186 (4.72) | .206 (5.23) |
| C | .327 (8.31) | .333 (8.46) | K | | .006 (0.15) |
| D | .319 (8.10) | .321 (8.15) | N | .346 (8.79) | .356 (9.04) |
| E 75ohm | .128 (3.25) | .136 (3.45) | R | .015 (0.38) | .030 (0.76) |
| F | .204 (5.18) | | S | .414 (10.52) | |
| G | .327 (8.31) | | T | .188 (4.78) | .208 (5.28) |

Dimensions in inches with metric equivalents (mm) in parentheses.

ADAPTERS



FIGURE 1



FIGURE 2



FIGURE 3



FIGURE 4

TERMINATION



FIGURE 5

BULKHEAD JACK



FIGURE 6

RECEPTACLES



FIGURE 7

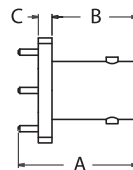

FIGURE 8



FIGURE 9

| Item Number | Military PN | Product Description | Gender | Finish | Dimensions | | | | Cable Group | Cable Procedure | Crimp Die | Mounting Hole | Figure # |
|--------------|-------------|---|--------|--------|------------|-------|-------|---|-------------|-----------------|-----------|---------------|----------|
| | | | | | A | B | C | D | | | | | |
| 2029-9-9 | | Adapter, Bulkhd, Jk-Jk | F-F | Nickel | 1.280 | 0.690 | | | | | X | 1 | |
| 2029-17-9 QD | | Adapter, Bulkhd, Jk-Jk, Iso Gd, Hex | F-F | Nickel | 1.280 | 0.630 | | | | | X | 1 | |
| 2029-33-9 | | Adapter, Bulkhd, Jk-Jk, Iso Gd, Spanner | F-F | Nickel | 1.280 | 0.630 | | | | | X | 1 | |
| 2029-15-9 | | Adapter, Jk-Jk | F-F | Nickel | 1.280 | | | | | | | 2 | |
| 2029-20-9 | | Adapter, Rt Angle, Jk-Plg | F-M | Nickel | 1.030 | 0.900 | | | | | | 3 | |
| 2029-16-9 | | Adapter, Tee, Jk-Plg-Jk | F-M-F | Nickel | 1.280 | 1.060 | | | | | | 4 | |
| 2555-3-32 | | Termination, 0.1%, 1/2 Watt | M | Nickel | 1.000 | 0.570 | | | | | | 5 | |
| 2022-29-9 | | Jack, Bulkhd, Rear Mt | F | Nickel | 1.400 | 0.630 | | | 25 | CP-465 | KTH-2010 | X | 6 |
| 2022-32-9 | | Jack, Bulkhd, Rear Mt | F | Nickel | 1.220 | 0.500 | | | 26 | 3-661-1 | KTH-2185 | AB | 6 |
| 2022-17-29 | | Jack, Bulkhd, Rear Mt | F | Nickel | 1.610 | 0.690 | | | 30 | 3-661-5 | KTH-2186 | X | 6 |
| 2022-18-29 | | Jack, Bulkhd, Rear Mt | F | Nickel | 1.610 | 0.630 | | | 31 | 3-661-5 | KTH-2185 | X | 6 |
| 2022-28-9 | | Jack, Bulkhd, Rear Mt | F | Nickel | 1.400 | 0.241 | | | Q | CP-465 | KTH-2010 | X | 6 |
| 2024-7-9 | | Receptacle, Bulkhd, Jack | F | Nickel | 1.060 | 0.500 | | | | SOLDER | | H | 7 |
| 2027-17-29 | | Receptacle, PCB | F | Nickel | 0.780 | 0.560 | 0.090 | | | SOLDER | | | 8 |
| 2024-16-9 | | Receptacle, Bulkhd, Plug | M | Nickel | 1.130 | 0.723 | 0.573 | | | SOLDER | | AB | 9 |

ANGLE PLUGS

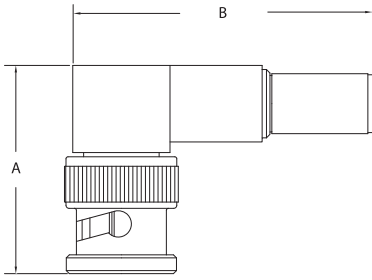

FIGURE 10



FIGURE 11

PLUGS



FIGURE 12

| Item Number | Military PN | Product Description | Gender | Finish | Dimensions | | | | Cable Group | Cable Procedure | Crimp Die | Mounting Hole | Figure # |
|---------------|-------------|-------------------------------------|--------|--------|------------|-------|---|---|-------------|-----------------|-----------|---------------|----------|
| | | | | | A | B | C | D | | | | | |
| 2026-16-9 | | Plug, Crimp, Rt Angle | M | Nickel | 1.030 | 1.330 | | | 30 | 3-661-5 | KTH-2186 | | 10 |
| 2026-17-9 | | Plug, Crimp, Rt Angle | M | Nickel | 1.030 | 1.330 | | | 31 | 3-661-5 | KTH-2185 | | 10 |
| 2026-33-9 | | Plug, Crimp, Rt Angle | M | Nickel | 1.030 | 1.480 | | | 25 | 3-661-5 | KTH-2255 | | 10 |
| 2026-34-9 | | Plug, Crimp, Rt Angle | M | Nickel | 1.030 | 1.480 | | | Q | 3-661-5 | KTH-2119 | | 10 |
| 2026-35-9 | | Plug, Crimp, 45 Deg Angle | M | Nickel | 0.840 | 0.570 | | | 30 | 3-661-5 | KTH-2186 | | 11 |
| 2026-35-9 M66 | | Plug, Crimp, 45 Deg Angle, Bulk Pkg | M | Nickel | 0.840 | 0.570 | | | 30 | 3-661-5 | KTH-2186 | | 11 |
| 2026-36-9 | | Plug, Crimp, 45 Deg Angle | M | Nickel | 0.840 | 0.570 | | | 31 | 3-661-5 | KTH-2185 | | 11 |
| 2026-36-9 M66 | | Plug, Crimp, 45 Deg Angle, Bulk Pkg | M | Nickel | 0.840 | 0.570 | | | 31 | 3-661-5 | KTH-2185 | | 11 |
| 2025-44-9 | | Plug, Crimp | M | Nickel | 1.200 | 0.570 | | | 31 | 3-661-5 | KTH-2185 | | 12 |
| 2025-44-9 M66 | | Plug, Crimp, Bulk Pkg | M | Nickel | 1.200 | 0.570 | | | 31 | 3-682 | KTH-2185 | | 12 |
| 2025-76-9 | | Plug, Crimp | M | Nickel | 1.200 | 0.570 | | | 30 | 3-661-5 | KTH-2186 | | 12 |
| 2065-1-9 | | Plug, Crimp | M | Nickel | 1.220 | 0.570 | | | 27 | 3-661-1 | KTH-2261 | | 12 |
| 2065-1-9 M66 | | Plug, Crimp, Bulk Pkg | M | Nickel | 1.220 | 0.570 | | | 27 | 3-661-1 | KTH-2261 | | 12 |
| 2065-2-9 | | Plug, Crimp | M | Nickel | 1.220 | 0.570 | | | 24 | 3-661-1 | KTH-2261 | | 12 |
| 2065-2-9 M66 | | Plug, Crimp, Bulk Pkg | M | Nickel | 1.220 | 0.570 | | | 24 | 3-661-1 | KTH-2261 | | 12 |
| 2065-7-9 | | Plug, Crimp | M | Nickel | 1.220 | 0.570 | | | G1 | 3-661-1 | KTH-2261 | | 12 |
| 2065-7-9 M66 | | Plug, Crimp, Bulk Pkg | M | Nickel | 1.220 | 0.570 | | | G1 | 3-661-1 | KTH-2261 | | 12 |
| 2065-8-9 | | Plug, Crimp | M | Nickel | 1.220 | 0.570 | | | 81 | 3-661-3 | KTH-2004 | | 12 |
| 2065-8-9 M66 | | Plug, Crimp, Bulk Pkg | M | Nickel | 1.220 | 0.570 | | | 81 | 3-661-3 | KTH-2004 | | 12 |
| 2065-10-9 | | Plug, Crimp | M | Nickel | 1.220 | 0.570 | | | 25 | 3-661-4 | KTH-2255 | | 12 |
| 2065-10-9 M66 | | Plug, Crimp, Bulk Pkg | M | Nickel | 1.220 | 0.570 | | | 25 | 3-661-4 | KTH-2255 | | 12 |
| 2065-11-9 | | Plug, Crimp | M | Nickel | 1.220 | 0.570 | | | 26 | 3-661-1 | KTH-2025 | | 12 |
| 2065-11-9 M66 | | Plug, Crimp, Bulk Pkg | M | Nickel | 1.220 | 0.570 | | | 26 | 3-661-1 | KTH-2025 | | 12 |
| 2065-15-9 | | Plug, Crimp | M | Nickel | 1.220 | 0.570 | | | Q | 3-661-4 | KTH-2119 | | 12 |
| 2065-15-9 M66 | | Plug, Crimp, Bulk Pkg | M | Nickel | 1.220 | 0.570 | | | Q | 3-661-4 | KTH-2119 | | 12 |
| 2065-28-9 | | Plug, Crimp | M | Nickel | 1.210 | 0.560 | | | 23B | 3-661-1 | KTH-2258 | | 12 |
| 2065-29-9 | | Plug, Crimp | M | Nickel | 1.210 | 0.560 | | | 23A | 3-764-1 | KTH-2276 | | 12 |

LONG BARREL BNC



- 75 Ohm performance suitable for Analog, Serial Digital and HDTV applications.
- Meets or exceeds SMPTE 424M (3G-SDI) requirements.
- Several configurations available to fit a variety of cables.
- Simple, full crimp design for easy field installation.
- Quick connect and disconnect with Bayonet coupling.
- Ergonomic Design - longer grip

SPECIFICATIONS

MATERIAL

Body: Brass
 Outer Contact: Beryllium Copper
 Insulator: PTFE
 K-Grip Sleeve: Commercial Bronze

FINISHES

Body: Nickel
 Contacts: Gold

ELECTRICAL

Impedance: 75 Ohms
 Voltage Rating: 500 Volts RMS
 Return Loss: 1.5 GHz, < -31 dB min
 3 GHz, < -24 dB min
 6 GHz, < -20 dB min
 Contact Resistance: Center 0.0014 Ohms
 Outer 0.002 Ohms
 Insulation Resistance: 5000 megohms

MECHANICAL

Life: 500 cycles minimum
 Cable Retention: 10 lbs to 40 lbs, Depending on Cable Size

Engagement Force: 2.5 lbs maximum, Torque
 3.0 lbs maximum, Longitudinal

ENVIRONMENTAL

Temperature: -65°C to +165°C
 Moisture: 0 to 95%
 MIL-STD-202 Method 106
 Corrosion: MIL-STD-202 Method 101, Test Condition B
 Flammability: UL 94-VO Rated
 Vibration: MIL-STD-202 Method 204, Test Condition B
 Solvent Resistance: MIL-STD-202 Method 215

INTERFACE DIMENSIONS

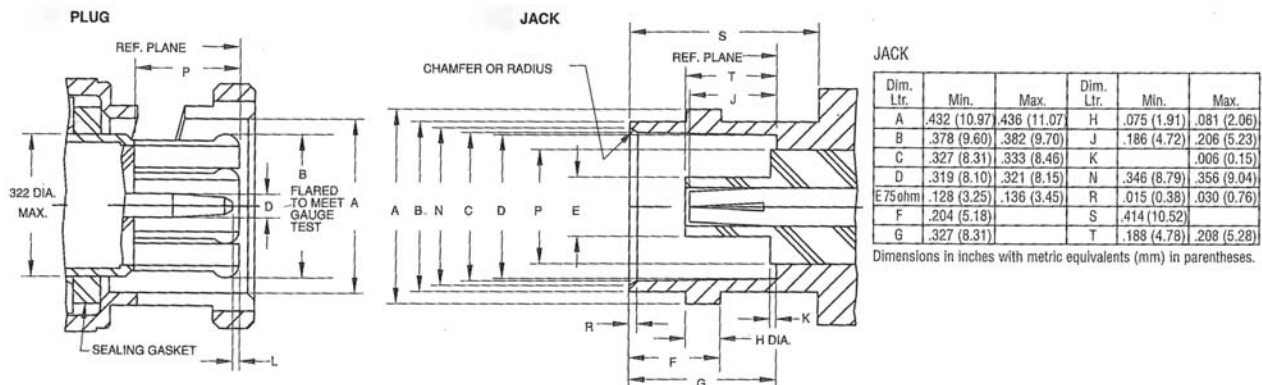

PLUGS

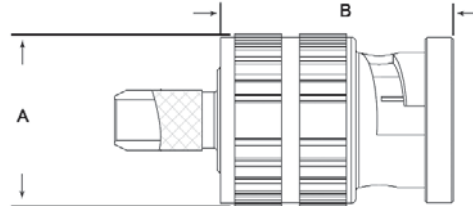

FIGURE 1

| Item Number | Military PN | Product Description | Gender | Finish | Dimensions | | Contact Hex | Ferrule Hex | Cable Group | Cable Procedure | Crimp Die | Mounting Hole | Figure # |
|-----------------|-------------|---------------------|--------|--------|------------|-------|-------------|-------------|-------------|-----------------|-----------|---------------|----------|
| | | | | | A | B | | | | | | | |
| 2065-E00-C7202N | | Plug, 75 Ohm | M | Nickel | 0.572 | 0.771 | 0.041 | 0.178 | 26 | 3-661-1 | KTH-5003 | | 1 |
| 2065-E00-C7102N | | Plug, 75 Ohm | M | Nickel | 0.572 | 0.771 | 0.041 | 0.255 | 24 | 3-661-1 | KTH-5003 | | 1 |
| 2065-E00-C9004N | | Plug, 75 Ohm | M | Nickel | 0.572 | 0.771 | 0.046 | 0.278 | 25 | 3-661-1 | KTH-5003 | | 1 |

PATCH PLUGS



- 75 Ohm Impedance, HDTV capable.
- Made to fit a variety of industry leading cables.
- Simple crimp style design allows for quick and easy field installation.
- Standard Size patch plugs mate with Standard Size video jacks (.090(Pin Size)
- Mid-Size patch plugs mate with Mid-Size video jacks (.050(Pin Size)

SPECIFICATIONS

MATERIAL

| | |
|----------------|-------------------|
| Body: | Brass |
| Contacts: | Brass |
| Insulators: | PTFE |
| Crimp Sleeves: | Commercial Bronze |

FINISHES

| | |
|-----------|--------|
| Body: | Nickel |
| Contacts: | Gold |

ELECTRICAL

| | |
|------------------|---------------|
| Impedance: | 75 Ohms |
| Frequency Range: | DC to 2.5 GHz |
| Voltage Rating: | 500 VRMS |

PATCH PLUG TERMINATION

- 75 Ohm Impedance, operates to 2.5 GHz.
- Durable construction.
- Eliminates open circuits by matching impedance of the connected line.
- Prevents signal reflection and possible associated equipment malfunction.

MECHANICAL

| | |
|-------|--------------------|
| Life: | 500 cycles minimum |
|-------|--------------------|

ENVIRONMENTAL

| | |
|------------|------------------------|
| Moisture: | MIL-STD-202 Method 106 |
| Corrosion: | MIL-STD-202 Method 101 |

INTERFACE DIMENSIONS

Mid-Size



Standard



PLUGS



FIGURE 1



FIGURE 2

TERMINATION



FIGURE 3

| Item Number | Military PN | Product Description | Gender | Finish | Dimensions | | | | Cable Group | Cable Procedure | Crimp Die | Mounting Hole | Figure # |
|-------------|-------------|---------------------------|--------|--------|------------|-------|---|---|-------------|-----------------|-----------|---------------|----------|
| | | | | | A | B | C | D | | | | | |
| 7410-10 QD | | Patch Plug, Mid-Size | M | Nickel | 1.770 | 0.298 | | | 26 | CP-401 | KTH-2025 | | 1 |
| 7410-16 | | Patch Plug, Mid-Size | M | Nickel | 1.790 | 0.298 | | | 25 | CP-401 | KTH-2255 | | 1 |
| 7410-20 | | Patch Plug, Mid-Size | M | Nickel | 1.790 | 0.298 | | | 24 | CP-401 | KTH-2261 | | 1 |
| 7510-1 | | Patch Plug, Standard Size | M | Nickel | 2.280 | 0.375 | | | G1 | CP-470 | KTH-2002 | | 1 |
| 7510-16 QD | | Patch Plug, Standard Size | M | Nickel | 2.280 | 0.375 | | | 25 | CP-470 | KTH-2267 | | 1 |
| 7510-21 | | Patch Plug, Standard Size | M | Nickel | 2.280 | 0.375 | | | 24 | CP-470 | KTH-2261 | | 1 |
| 7510-4 | | Patch Plug, Standard Size | M | Nickel | 2.280 | 0.375 | | | Q | CP-470 | KTH-2012 | | 1 |
| 7410-14 | | Patch Plug, Mid-Size | M | Nickel | 1.550 | 0.300 | | | 30 | 3-661-5 | KTH-2286 | | 2 |
| 7410-15 | | Patch Plug, Mid-Size | M | Nickel | 1.610 | 0.300 | | | 31 | 3-680 | KTH-2185 | | 2 |
| 7510-7 | | Patch Termination, 75 Ohm | M | Nickel | 3.250 | 0.375 | | | | | | | 3 |



- Pre-assembled for quick and easy installation.
- Available in 10 popular colors for visual signal identification or other personalization.
- Matching protective boots also included.

STANDARD SIZE:

- Each assembly contains two KINGS® Standard Size 75 Ohm patch plugs (7510-16).
- Terminated to Belden 1694A or equivalent cable in a variety of lengths.

MID-SIZE:

- Each assembly contains two KINGS® Mid-Size 75 Ohm patch plugs (7410-10).
- Terminated to Belden 1855A or equivalent cable in a variety of lengths.

| ** | COLOR |
|-----|--------|
| -01 | BROWN |
| -02 | RED |
| -03 | ORANGE |
| -04 | YELLOW |
| -05 | GREEN |
| -06 | BLUE |
| -07 | VIOLET |
| -08 | GREY |
| -09 | WHITE |
| -10 | BLACK |

CORDS

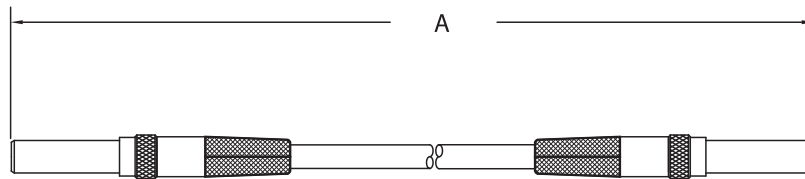
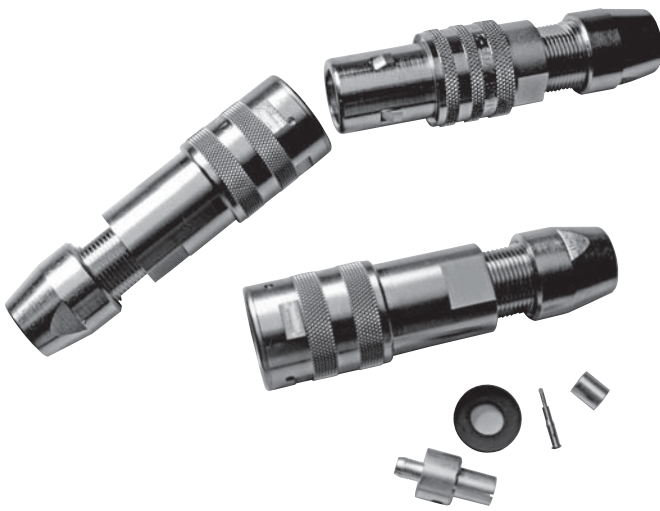

FIGURE 1

| Item Number | Military PN | Product Description | Gender | Finish | Dimensions | | | | Cable Group | Cable Procedure | Crimp Die | Mounting Hole | Figure # |
|---------------|-------------|-----------------------------------|------------|--------|------------|---|---|---|-------------|-----------------|-----------|---------------|----------|
| | | | | | A | B | C | D | | | | | |
| K-8845-012-** | | Standard Size, Belden 1694A, 12" | PATCH(M-M) | | 12.000 | | | | | | | | 1 |
| K-8845-120-** | | Standard Size, Belden 1694A, 120" | PATCH(M-M) | | 120.000 | | | | | | | | 1 |
| K-8845-018-** | | Standard Size, Belden 1694A, 18" | PATCH(M-M) | | 18.000 | | | | | | | | 1 |
| K-8845-024-** | | Standard Size, Belden 1694A, 24" | PATCH(M-M) | | 24.000 | | | | | | | | 1 |
| K-8845-036-** | | Standard Size, Belden 1694A, 36" | PATCH(M-M) | | 36.000 | | | | | | | | 1 |
| K-8845-048-** | | Standard Size, Belden 1694A, 48" | PATCH(M-M) | | 48.000 | | | | | | | | 1 |
| K-8845-060-** | | Standard Size, Belden 1694A, 60" | PATCH(M-M) | | 60.000 | | | | | | | | 1 |
| K-8845-072-** | | Standard Size, Belden 1694A, 72" | PATCH(M-M) | | 72.000 | | | | | | | | 1 |
| K-8845-084-** | | Standard Size, Belden 1694A, 84" | PATCH(M-M) | | 84.000 | | | | | | | | 1 |
| K-8845-096-** | | Standard Size, Belden 1694A, 96" | PATCH(M-M) | | 96.000 | | | | | | | | 1 |
| K-8846-012-** | | Mid-Size, Belden 1855A, 12" | PATCH(M-M) | | 12.000 | | | | | | | | 1 |
| K-8846-120-** | | Mid-Size, Belden 1855A, 120" | PATCH(M-M) | | 120.000 | | | | | | | | 1 |
| K-8846-144-** | | Mid-Size, Belden 1855A, 144" | PATCH(M-M) | | 144.000 | | | | | | | | 1 |
| K-8846-024-** | | Mid-Size, Belden 1855A, 24" | PATCH(M-M) | | 24.000 | | | | | | | | 1 |
| K-8846-288-** | | Mid-Size, Belden 1855A, 288" | PATCH(M-M) | | 288.000 | | | | | | | | 1 |
| K-8846-036-** | | Mid-Size, Belden 1855A, 36" | PATCH(M-M) | | 36.000 | | | | | | | | 1 |
| K-8846-048-** | | Mid-Size, Belden 1855A, 48" | PATCH(M-M) | | 48.000 | | | | | | | | 1 |
| K-8846-060-** | | Mid-Size, Belden 1855A, 60" | PATCH(M-M) | | 60.000 | | | | | | | | 1 |
| K-8846-072-** | | Mid-Size, Belden 1855A, 72" | PATCH(M-M) | | 72.000 | | | | | | | | 1 |
| K-8846-096-** | | Mid-Size, Belden 1855A, 96" | PATCH(M-M) | | 96.000 | | | | | | | | 1 |



SPECIFICATIONS

MATERIAL

| | |
|------------------|---|
| Body: | Brass |
| Center Contacts: | Brass (Male) Beryllium Copper (Female) |
| Insulators: | PTFE |
| Spring Member: | Beryllium Copper |

FINISHES

| | |
|------------------|------------------|
| Body: | Nickel |
| Center Contacts: | Gold over Nickel |
| Outer Contacts: | Silver |

ELECTRICAL

| | |
|-----------------|--|
| Impedance: | 75 Ohms |
| Return Loss: | Up to 500 MHz, -20 dB minimum Up to 750 MHz, -17 dB minimum |
| Operating Freq: | DC to 2.5 GHz |

MECHANICAL

| | |
|------------------|--|
| Life: | 30,000 cycles minimum |
| Cable Retention: | 140 lbs minimum, 1/2" diameter cable 100 lbs minimum, 3/8" diameter cable |

ENVIRONMENTAL

| | |
|--------------|------------------------------------|
| Moisture: | 0 to 98% MIL-STD-202 Method 106 |
| Temperature: | -20° to +70° C |
| Corrosion: | MIL-STD-202 Method 101 |

- Durable weatherproof construction— Ideal for outdoor use.
- Performs in even the harshest environments.
- Easy, two-crimp installation of plugs and jacks.
- Push-on, pull-apart mating.
- Non-conductive anti-shock safety tip on contacts.
- 75 Ohm Impedance.
- Adapters are available in a variety of configurations.
- Inspection gauges allow for quick and easy verification of interface dimensions and proper mating.
- Inexpensive retrofit kits for field replacement of damaged or non-functioning internal Tri-Loc® parts.

STANDARD PLUG



FIGURE 1

ANGLE PLUG

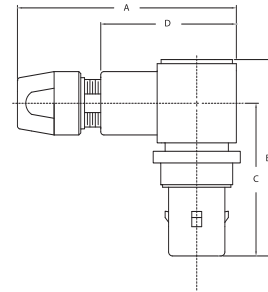

FIGURE 2

BULKHEAD PLUG - FRONT MOUNT



FIGURE 3

STANDARD JACK

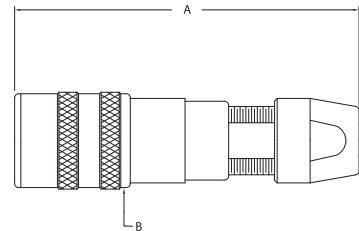

FIGURE 4

| Item Number | Military PN | Product Description | Gender | Finish | A | Dimensions | | | Cable Group | Cable Procedure | Crimp Die | Mounting Hole | Figure # |
|-----------------|-------------|------------------------|--------|--------|-------|------------|-------|-------|-------------|-----------------|-----------|---------------|----------|
| | | | | | | B | C | D | | | | | |
| 7705-1 | | Plug | M | Nickel | 3.880 | 1.140 | | | 70 | KAI-8010 | KTH-2040 | | 1 |
| 7705-2 | | Plug | M | Nickel | 3.880 | 1.140 | | | 73 | KAI-8010 | KTH-2002 | | 1 |
| 7705-3 | | Plug | M | Nickel | 3.880 | 1.140 | | | 74 | KAI-8010 | KTH-2041 | | 1 |
| 7705-9 | | Plug | M | Nickel | 3.880 | 1.140 | | | 76 | KAI-8010 | KTH-2002 | | 1 |
| 7705-4 | | Plug | M | Nickel | 3.880 | 1.140 | | | 78 | KAI-8010 | KTH-2002 | | 1 |
| 7705-6 | | Plug | M | Nickel | 3.880 | 1.140 | | | 79 | KAI-8010 | KTH-2040 | | 1 |
| 7705-5 | | Plug | M | Nickel | 3.880 | 1.140 | | | 80 | KAI-8010 | KTH-2012 | | 1 |
| 7706-1 | | Plug, Angle | M | Nickel | 3.440 | 3.100 | 2.410 | 2.140 | 73 | 3-499 | | | 2 |
| 7706-2 | | Plug, Angle | M | Nickel | 3.440 | 3.100 | 2.410 | 2.140 | 74 | 3-499 | | | 2 |
| 7702-1 | | Plug, Bulkhd, Front Mt | M | Nickel | 3.880 | 1.950 | | | 70 | KAI-8010 | KTH-2040 | AH | 3 |
| 7702-2 | | Plug, Bulkhd, Front Mt | M | Nickel | 3.880 | 1.950 | | | 73 | KAI-8010 | KTH-2002 | AH | 3 |
| 7702-3 | | Plug, Bulkhd, Front Mt | M | Nickel | 3.880 | 1.950 | | | 74 | KAI-8010 | KTH-2041 | AH | 3 |
| KP-8012-767-400 | | Plug, Bulkhd, Front Mt | M | Nickel | 3.880 | 1.950 | | | 76 | KAI-8010 | KTH-2002 | AH | 3 |
| 7702-14 | | Plug, Bulkhd, Front Mt | M | Nickel | 3.880 | 1.950 | | | 79 | KAI-8011 | KTH-2040 | AH | 3 |
| 7703-1 | | Jack | F | Nickel | 4.000 | 1.120 | | | 70 | KAI-8010 | KTH-2040 | | 4 |
| 7703-2 | | Jack | F | Nickel | 4.000 | 1.120 | | | 73 | KAI-8010 | KTH-2002 | | 4 |
| 7703-3 | | Jack | F | Nickel | 4.000 | 1.120 | | | 74 | KAI-8010 | KTH-2041 | | 4 |
| 7703-9 | | Jack | F | Nickel | 4.000 | 1.120 | | | 76 | KAI-8010 | KTH-2002 | | 4 |
| 7703-6 | | Jack | F | Nickel | 4.000 | 1.120 | | | 78 | KAI-8010 | KTH-2002 | | 4 |
| 7703-8 | | Jack | F | Nickel | 4.000 | 1.120 | | | 79 | KAI-8010 | KTH-2040 | | 4 |
| 7703-7 | | Jack | F | Nickel | 4.000 | 1.120 | | | 80 | KAI-8010 | KTH-2012 | | 4 |

ANGLE JACK



FIGURE 5

**ANGLE BULKHEAD JACK
REAR MOUNT**



FIGURE 6

BULKHEAD JACK - FRONT MOUNT



FIGURE 7

BULKHEAD JACK - REAR MOUNT

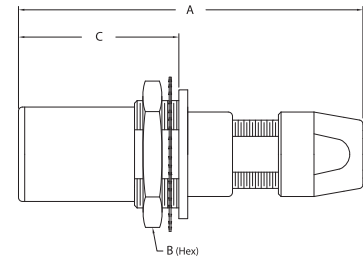

FIGURE 8

| Item Number | Military PN | Product Description | Gender | Finish | Dimensions | | | | Cable Group | Cable Procedure | Crimp Die | Mounting Hole | Figure # |
|-----------------|-------------|------------------------------|--------|--------|------------|-------|-------|---|-------------|-----------------|-----------|---------------|----------|
| | | | | | A | B | C | D | | | | | |
| 7703-4 | | Jack, Angle | F | Nickel | 3.440 | 2.490 | | | 73 | 3-499 | | | 5 |
| 7703-5 | | Jack, Angle | F | Nickel | 3.440 | 2.490 | | | 74 | 3-499 | | | 5 |
| 7702-10 | | Jack, Angle, Bulkhd, Rear Mt | F | Nickel | 3.440 | 2.490 | 0.250 | | 70 | 3-499 | | AG | 6 |
| 7702-11 | | Jack, Angle, Bulkhd, Rear Mt | F | Nickel | 3.440 | 2.490 | 0.250 | | 73 | 3-499 | | AG | 6 |
| 7702-12 | | Jack, Angle, Bulkhd, Rear Mt | F | Nickel | 3.440 | 2.490 | 0.250 | | 74 | 3-499 | | AG | 6 |
| 7702-4 | | Jack, Bulkhd, Front Mt | F | Nickel | 4.000 | 1.480 | | | 70 | KAI-8010 | KTH-2040 | AH | 7 |
| 7702-5 | | Jack, Bulkhd, Front Mt | F | Nickel | 4.000 | 1.480 | | | 73 | KAI-8010 | KTH-2002 | AH | 7 |
| 7702-6 | | Jack, Bulkhd, Front Mt | F | Nickel | 4.000 | 1.480 | | | 74 | KAI-8010 | KTH-2041 | AH | 7 |
| 7702-13 | | Jack, Bulkhd, Front Mt | F | Nickel | 4.000 | 1.480 | | | 76 | KAI-8010 | KTH-2002 | AH | 7 |
| 7702-17 | | Jack, Bulkhd, Front Mt | F | Nickel | 4.000 | 1.480 | | | 78 | KAI-8010 | KTH-2002 | AH | 7 |
| 7702-15 | | Jack, Bulkhd, Front Mt | F | Nickel | 4.000 | 1.480 | | | 79 | KAI-8011 | KTH-2040 | AH | 7 |
| 7702-7 | | Jack, Bulkhd, Rear Mt | F | Nickel | 4.000 | 1.500 | 1.830 | | 70 | KAI-8010 | KTH-2040 | AH | 8 |
| 7702-8 | | Jack, Bulkhd, Rear Mt | F | Nickel | 4.000 | 1.500 | 1.830 | | 73 | KAI-8010 | KTH-2002 | AH | 8 |
| 7702-9 | | Jack, Bulkhd, Rear Mt | F | Nickel | 4.000 | 1.500 | 1.830 | | 74 | KAI-8010 | KTH-2041 | AH | 8 |
| KP-8021-767-400 | | Jack, Bulkhd, Rear Mt | F | Nickel | 4.000 | 1.500 | 1.830 | | 76 | KAI-8010 | KTH-2002 | AH | 8 |

ADAPTERS

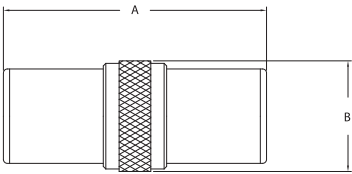

FIGURE 9



FIGURE 10

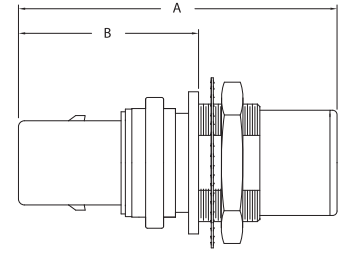

FIGURE 11



FIGURE 12



FIGURE 13



FIGURE 14



FIGURE 15

| Item Number | Military PN | Product Description | Gender | Finish | A | B | Dimensions C | D | Cable Group | Cable Procedure | Crimp Die | Mounting Hole | Figure # |
|-----------------|-------------|----------------------------------|-----------------|--------|-------|-------|--------------|---|-------------|-----------------|-----------|---------------|----------|
| 7709-1 | | Adapter, Jack-Jack | F-F | Nickel | 2.750 | 1.260 | | | | | | | 9 |
| 7709-2 | | Adapter, Jack-Jack, Blkhd | F-F | Nickel | 2.750 | 1.500 | 0.250 | | | | | AG | 10 |
| 7709-3 | | Adapter, Jack-Jack, Blkhd | F-F | Nickel | 2.750 | 1.500 | 0.250 | | | | | AH | 10 |
| 7709-5 | | Adapter, Jack-Plug, Blkhd | F-M | Nickel | 3.350 | 1.950 | | | | | | AH | 11 |
| 7709-6 | | Adapter, Plug-Plug | M-M | Nickel | 4.000 | | | | | | | | 12 |
| KP-8001-001-012 | | Adapter, Bulkhd, Tri-Loc® to BNC | TLOC(M)-BNC(F) | Nickel | 2.880 | 1.120 | 0.233 | | | | | AD | 13 |
| KP-8001-002-012 | | Adapter, Bulkhd, Tri-Loc® to BNC | TLOC(M)-BNC(F) | Nickel | 2.880 | 1.120 | 0.233 | | | | | AE | 13 |
| KP-8002-002-012 | | Adapter, Bulkhd, Tri-Loc® to BNC | TLOC(F)-BNC(F) | Nickel | 2.150 | 1.120 | 0.318 | | | | | AE | 14 |
| 7709-8 | | Adapter, Panel, Tri-Loc® to SMB | TLOC(M)-SMB (F) | Nickel | 2.690 | 1.380 | 0.890 | | | | | AJ | 15 |

**BULKHEAD RECEPTACLE
FRONT MOUNT**



FIGURE 16

**PANEL RECEPTACLE
FRONT MOUNT**



FIGURE 17

RETRO-FIT KITS, INSPECTION GAUGES

| Item Number | Military PN | Product Description | Gender | Finish | Dimensions | | | | Cable Group | Cable Procedure | Crimp Die | Mounting Hole | Figure # |
|-------------|-------------|--|--------|--------|------------|-------|-------|---|-------------|-----------------|-----------|---------------|----------|
| | | | | | A | B | C | D | | | | | |
| 7704-1 | | Receptacle, Bulkhd, Front Mt | F | Nickel | 1.970 | 1.250 | 1.250 | | | SOLDER | | AD | 16 |
| 7704-2 | | Receptacle, Bulkhd, Front Mt | F | Nickel | 1.970 | 1.250 | 1.250 | | | SOLDER | | AE | 16 |
| 7704-3 | | Receptacle, Bulkhd, Front Mt | F | Nickel | 1.970 | 1.250 | 1.250 | | | SOLDER | | AF | 16 |
| 7704-4 | | Receptacle, Bulkhd, Front Mt | F | Nickel | 1.970 | 1.250 | 1.250 | | | SOLDER | | AC | 16 |
| 7704-5 | | Receptacle, Bulkhd, Front Mt | M | Nickel | 2.570 | 1.500 | 1.250 | | | SOLDER | | AD | 16 |
| 7704-6 | | Receptacle, Bulkhd, Front Mt | M | Nickel | 2.570 | 1.500 | 1.250 | | | SOLDER | | AE | 16 |
| 7704-7 | | Receptacle, Bulkhd, Front Mt | M | Nickel | 2.570 | 1.500 | 1.250 | | | SOLDER | | AF | 16 |
| 7704-8 | | Receptacle, Bulkhd, Front Mt | M | Nickel | 2.570 | 1.500 | 1.250 | | | SOLDER | | AC | 16 |
| 7704-9 | | Receptacle, Bulkhd, Front Mt | F | Nickel | 2.570 | 1.378 | 1.000 | | | SOLDER | | AI | 16 |
| 7707-1 | | Receptacle, Panel | F | Nickel | 2.570 | 1.380 | 0.980 | | | SOLDER | | AK | 17 |
| 7708-4 | | Retrofit Kit, Standard Female, CG 70 | F | | | | | | 70 | | KTH-2040 | | |
| 7708-5 | | Retrofit Kit, Standard Female, CG 73/76/78 | F | | | | | | 73/76/78 | | KTH-2002 | | |
| 7708-6 | | Retrofit Kit, Standard Female, CG 74 | F | | | | | | 74 | | KTH-2041 | | |
| 7708-7 | | Retrofit Kit, Standard Female, CG 79 | F | | | | | | 79 | | KTH-2040 | | |
| 7708-12 | | Retrofit Kit, Standard Female, CG 80 | F | | | | | | 80 | | KTH-2012 | | |
| 7708-1 | | Retrofit Kit, Standard Male, CG 70 | M | | | | | | 70 | | KTH-2040 | | |
| 7708-8 | | Retrofit Kit, Standard Male, CG 79 | M | | | | | | 79 | | KTH-2040 | | |
| 7708-2 | | Retrofit Kit, Standard Male, CG 73/76/78 | M | | | | | | 73/76/78 | | KTH-2002 | | |
| 7708-3 | | Retrofit Kit, Standard Male, CG 74 | M | | | | | | 74 | | KTH-2041 | | |
| 7708-11 | | Retrofit Kit, Standard Male, CG 80 | M | | | | | | 80 | | KTH-2012 | | |
| KP-8000-063 | | Gauge, Inner Body to Center Conductor (F) | F | | | | | | | | | | |
| KP-8000-061 | | Gauge, Inner Body to Center Conductor (M) | M | | | | | | | | | | |
| KP-8000-062 | | Gauge, Inner Body to Outer Body (F) | F | | | | | | | | | | |
| KP-8000-060 | | Gauge, Inner Body to Outer Body (M) | M | | | | | | | | | | |



SPECIFICATIONS

MATERIAL

| | |
|----------------|-------------------|
| Body: | Brass |
| Entry Body: | Beryllium Copper |
| Insulators: | PTFE |
| Spring Member: | Beryllium Copper |
| Crimp Sleeves: | Commercial Bronze |

FINISHES

| | |
|------------------|--------|
| Body: | Nickel |
| Center Contacts: | Gold |

ELECTRICAL

| | |
|-----------------|--|
| Impedance: | 75 Ohms |
| Return Loss: | Up to 500 MHz, -20 dB minimum Up to 750 MHz, -17 dB minimum |
| Operating Freq: | DC to 2.5 GHz |

MECHANICAL

| | |
|------------------|--|
| Life: | 30,000 cycles minimum |
| Cable Retention: | 140 lbs minimum, 1/2" diameter cable 100 lbs minimum, 3/8" diameter cable |

ENVIRONMENTAL

| | |
|--------------|------------------------------------|
| Moisture: | 0 to 98% MIL-STD-202 Method 106 |
| Temperature: | -20° to +70° C |
| Corrosion: | MIL-STD-202 Method 101 |

- 75 Ohm performance is suitable for Analog, Serial Digital, and HDTV.
- Rugged weatherproof design—Ideal for outdoor use.
- Meets or exceeds SMPTE 292 requirements.
- Mates with Fischer 1051 Series triaxial connectors.
- Push-on coupling with audible “snap” to ensure proper mating.
- Plugs and jacks available for 8mm, 11mm, and 14mm cables.
- Retro Fit kits available for field replacement without re-termination of entire connector.

STANDARD JACK

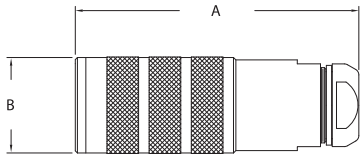

FIGURE 1

BULKHEAD JACK - FRONT MOUNT



FIGURE 2

BULKHEAD RECEPTACLE - FRONT MOUNT



FIGURE 3

| Item Number | Military PN | Product Description | Gender | Finish | Dimensions | | | | Cable Group | Cable Procedure | Crimp Die | Mounting Hole | Figure # |
|-------------|-------------|--------------------------|--------|--------|------------|-------|-------|---|-------------|-----------------|----------------------|---------------|----------|
| | | | | | A | B | C | D | | | | | |
| 780370 | | Jack, Crimp | F | Nickel | 2.690 | 0.905 | | | 70 | 3-651 | KTH-2040 KTH-2043 | | 1 |
| 780373 | | Jack, Crimp | F | Nickel | 2.690 | 0.905 | | | 73 | 3-651 | KTH-8001 | | 1 |
| 780374 | | Jack, Crimp | F | Nickel | 2.690 | 0.905 | | | 74 | 3-651 | KTH-8002 | | 1 |
| 780376 | | Jack, Crimp | F | Nickel | 2.690 | 0.905 | | | 76 | 3-651 | KTH-8001 | | 1 |
| 780380 | | Jack, Crimp | F | Nickel | 2.690 | 0.905 | | | 80 | 3-651 | KTH-2004 KTH-2012 | | 1 |
| 780390 | | Jack, Crimp | F | Nickel | 2.690 | 0.905 | | | 90 | 3-651 | KTH-2267 KTH-2260 | | 1 |
| 780270 | | Jack, Crimp, Bulkhd | F | Nickel | 2.690 | 0.905 | 1.187 | | 70 | 3-651 | KTH-2040 KTH-2043 | AL | 2 |
| 780273 | | Jack, Crimp, Bulkhd | F | Nickel | 2.690 | 0.905 | 1.187 | | 73 | 3-651 | KTH-8001 | AL | 2 |
| 780274 | | Jack, Crimp, Bulkhd | F | Nickel | 2.690 | 0.905 | 1.187 | | 74 | 3-651 | KTH-8002 | AL | 2 |
| 780276 | | Jack, Crimp, Bulkhd | F | Nickel | 2.690 | 0.905 | 1.187 | | 76 | 3-651 | KTH-8001 | AL | 2 |
| 780280 | | Jack, Crimp, Bulkhd | F | Nickel | 2.690 | 0.905 | 1.187 | | 80 | 3-651 | KTH-2004 KTH-2012 | AL | 2 |
| 780290 | | Jack, Crimp, Bulkhd | F | Nickel | 2.690 | 0.905 | 1.187 | | 90 | 3-651 | KTH-2267 KTH-2260 | AL | 2 |
| 781273 | | Receptacle, Plug, Bulkhd | M | Nickel | 1.580 | 1.416 | 1.250 | | 73 | 3-794 | | AM | 3 |

STANDARD PLUG



FIGURE 4

BULKHEAD PLUG - FRONT MOUNT

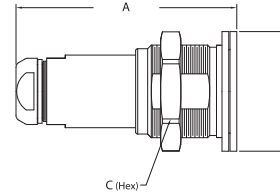

FIGURE 5

RETRO-FIT KITS

| Item Number | Military PN | Product Description | Gender | Finish | Dimensions | | | | Cable Group | Cable Procedure | Crimp Die | Mounting Hole | Figure # |
|-------------|-------------|-----------------------------|--------|--------|------------|-------|-------|---|-------------|-----------------|----------------------|---------------|----------|
| | | | | | A | B | C | D | | | | | |
| 780670 | | Plug, Crimp | M | Nickel | 2.529 | 0.744 | | | 70 | 3-651 | KTH-2040 KTH-2043 | | 4 |
| 780673 | | Plug, Crimp | M | Nickel | 2.529 | 0.744 | | | 73 | 3-651 | KTH-8001 | | 4 |
| 780674 | | Plug, Crimp | M | Nickel | 2.529 | 0.744 | | | 74 | 3-651 | KTH-8002 | | 4 |
| 780676 | | Plug, Crimp | M | Nickel | 2.529 | 0.744 | | | 76 | 3-651 | KTH-8001 | | 4 |
| 780680 | | Plug, Crimp | M | Nickel | 2.529 | 0.744 | | | 80 | 3-651 | KTH-2004 KTH-2012 | | 4 |
| 780690 | | Plug, Crimp | M | Nickel | 2.529 | 0.744 | | | 90 | 3-651 | KTH-2267 KTH-2260 | | 4 |
| 780570 | | Plug, Crimp, Bulkhd | M | Nickel | 2.614 | 1.416 | 1.250 | | 70 | 3-651 | KTH-2040 KTH-2043 | AM | 5 |
| 780573 | | Plug, Crimp, Bulkhd | M | Nickel | 2.614 | 1.416 | 1.250 | | 73 | 3-651 | KTH-8001 | AM | 5 |
| 780574 | | Plug, Crimp, Bulkhd | M | Nickel | 2.614 | 1.416 | 1.250 | | 74 | 3-651 | KTH-8002 | AM | 5 |
| 780576 | | Plug, Crimp, Bulkhd | M | Nickel | 2.614 | 1.416 | 1.250 | | 76 | 3-651 | KTH-8001 | AM | 5 |
| 780580 | | Plug, Crimp, Bulkhd | M | Nickel | 2.614 | 1.416 | 1.250 | | 80 | 3-651 | KTH-2004 KTH-2012 | AM | 5 |
| 780590 | | Plug, Crimp, Bulkhd | M | Nickel | 2.614 | 1.416 | 1.250 | | 90 | 3-651 | KTH-2267 KTH-2260 | AM | 5 |
| 783870 | | Retrofit Kit, Female, CG 70 | F | | | | | | 70 | | | | |
| 783873 | | Retrofit Kit, Female, CG 73 | F | | | | | | 73 | | | | |
| 783874 | | Retrofit Kit, Female, CG 74 | F | | | | | | 74 | | | | |
| 783876 | | Retrofit Kit, Female, CG 76 | F | | | | | | 76 | | | | |
| 783880 | | Retrofit Kit, Female, CG 80 | F | | | | | | 80 | | | | |
| 783890 | | Retrofit Kit, Female, CG 90 | F | | | | | | 90 | | | | |
| 785870 | | Retrofit Kit, Male, CG 70 | M | | | | | | 70 | | | | |
| 785873 | | Retrofit Kit, Male, CG 73 | M | | | | | | 73 | | | | |
| 785874 | | Retrofit Kit, Male, CG 74 | M | | | | | | 74 | | | | |
| 785876 | | Retrofit Kit, Male, CG 76 | M | | | | | | 76 | | | | |
| 785880 | | Retrofit Kit, Male, CG 80 | M | | | | | | 80 | | | | |
| 785890 | | Retrofit Kit, Male, CG 90 | M | | | | | | 90 | | | | |



- Quick connect Push/Pull system.
- Locking mechanism that will not vibrate loose as threaded connectors are prone to do.
- When mated, the connectors can rotate 360°.
- Allows for connectors to be 2-3 times more densely packed than BNC's.
- Operation up to 10 GHz.
- Supports 3Gbps HD SDI applications.
- Uses existing tooling.
- Crimp center contact.

SPECIFICATIONS

MATERIAL

| | |
|------------------|------------------|
| Body: | Brass |
| Center Contacts: | Beryllium Copper |
| Insulators: | PTFE |
| Ferrule: | Bronze |

FINISHES

| | |
|--------------------------|--------------------|
| Body: | Nickel over Copper |
| Outer & Center Contacts: | Gold over Nickel |
| Ferrule: | Nickel over Copper |

ELECTRICAL

| | |
|------------------|--|
| Impedance: | 75 Ohms |
| Return Loss: | 1 GHz < -32 dB 3 GHz < -23 dB 6 GHz < -15 dB |
| Frequency Range: | DC to 10 GHz |

MECHANICAL

| | |
|---------|---------------------|
| Life: | 500 cycles minimum |
| Mating: | Push/Pull, Slide-on |

PLUGS



FIGURE 1



FIGURE 2

PCB JACK



FIGURE 3

| Item Number | Military PN | Product Description | Gender | Finish | Dimensions | | | | Cable Group | Cable Procedure | Crimp Die | Mounting Hole | Figure # |
|-----------------|-------------|--------------------------------|--------|--------|------------|-------|-------|---|-------------|-----------------|-----------|---------------|----------|
| | | | | | A | B | C | D | | | | | |
| 0345-E00-C7201N | | Plug, 75 Ohm, Captured C/C | M | Nickel | 1.287 | 0.500 | 0.315 | | 26 | CAP-E02 | KTH-2025 | | 1 |
| 0345-E00-C7202N | | Plug, 75 Ohm | M | Nickel | 1.287 | 0.500 | 0.315 | | 26 | CAP-E03 | KTH-2025 | | 2 |
| 034B-060-00401H | | Jack, 75 Ohm, Right Angle, PCB | F | Gold | 0.292 | 0.808 | 0.670 | | | | | | 3 |

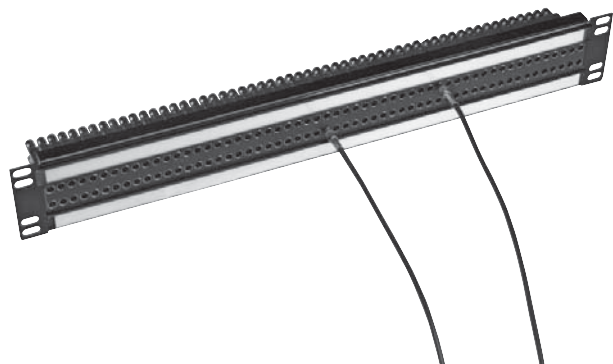

- 75 Ohm Nominal Impedance.
- Micro-miniature size permits higher circuit density - Up to 56 circuits per 19" panel.
- Positive locking equipment connections prevent accidental unmating.
- Crimp contacts allow for in-house installation.
- Patch and equipment plugs designed to terminate to popular industry cables, such as Belden 1855A and GepCo VDM 230.
- Frequency Range: Up to 2.4 GHz

SPECIFICATIONS

AUDIO-VIDEO JACKS:

MATERIAL

| | |
|--------------------------|-------------------|
| Plug Insulators: | PTFE |
| Top & Bottom Insulators: | Polymethylpentene |
| Termination Contacts: | Beryllium Copper |
| Female Contacts: | Beryllium Copper |
| Male Contacts: | Brass |
| All Other Metal Parts: | Zinc |

FINISHES

| | |
|------------------|--------|
| Contacts: | Gold |
| All Other Parts: | Nickel |

ELECTRICAL

| | |
|-------------------------|--|
| Impedance: | 75 Ohms |
| Frequency Range: | DC to 2.4 GHz |
| Voltage Rating: | 500 Volts RMS |
| Termination Resistance: | 75 Ohms, 2% |
| Return Loss: | -20 dB Maximum to 1.5 GHz -14 dB Maximum to 2.4 GHz |

MECHANICAL

| | |
|-------|---------------|
| Life: | 30,000 Cycles |
|-------|---------------|

PATCH AND EQUIPMENT PLUGS:

MATERIAL

| | |
|------------------------|-----------------|
| Insulators: | PTFE |
| Gaskets: | Silicone Rubber |
| All Other Metal Parts: | Brass |

FINISHES

| | |
|------------------|--------|
| Contacts: | Gold |
| All Other Parts: | Nickel |

ELECTRICAL

| | |
|------------------|---------------------------|
| Impedance: | 75 Ohms |
| Frequency Range: | DC to 2.4 GHz |
| Voltage Rating: | 500 Volts RMS |
| Return Loss: | -23 dB Maximum to 2.4 GHz |

MECHANICAL

| | |
|-------|---------------|
| Life: | 30,000 Cycles |
|-------|---------------|

PATCH PANEL:

MATERIAL

| | |
|--------------------------|--|
| Audio-Video Jacks: | See Specifications for Individual Products |
| Designation Strip Cover: | Lexan |
| Screws: | Brass |
| Face Panel: | Black GE Noryl or Arboron |
| All Other Metal Parts: | Cold Rolled Steel |

JACK

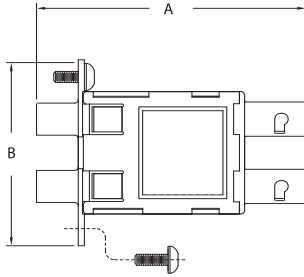

FIGURE 1

JACKFIELD



FIGURE 2

EQUIPMENT PLUG



FIGURE 3

PATCH PLUG



FIGURE 4

| Item Number | Military PN | Product Description | Gender | Finish | Dimensions | | | | Cable Group | Cable Procedure | Crimp Die | Mounting Hole | Figure # |
|-------------|-------------|---|--------|--------|------------|-------|-------|---|-------------|-----------------|-----------|---------------|----------|
| | | | | | A | B | C | D | | | | | |
| 8600-2 | | Mini Audio/Video Jack, Dual, Terminated | F | Nickel | 2.200 | 1.500 | | | | | | | 1 |
| 8601-1 | | Mini Audio/Video Jackfield | F | | 19.000 | 2.570 | 2.360 | | | | | | 2 |
| 8605-3-9 | | Mini Audio/Video Equipment Plug | M | Nickel | 1.430 | 0.200 | | | 26 | 3-661-6 | KTH-2025 | | 3 |
| 8608-2-9 | | Mini Audio/Video Patch Plug | M | Nickel | 1.640 | 0.200 | | | 26 | 3-661-6 | KTH-2025 | | 4 |

MID-SIZE VIDEO JACKS



- 75 Ohm Nominal Impedance – suitable for Analog, Serial Digital, and HDTV applications.
- Offers higher panel density and increased frequency range.
- Mates with standard BNC plugs and mid-size (0.050" center pin) patch plugs.
- Meets SMPTE 424M (3G-SDI) and HDTV standards.
- Terminated, un-terminated, and feed-through versions available in dual or single configurations.
- Frequency Range: Up to 3.5 GHz

SPECIFICATIONS

MATERIAL

| | |
|--------------|---------------------|
| Body: | Brass or Zinc Alloy |
| Contacts: | Beryllium Copper |
| Springs: | Beryllium Copper |
| Insulators: | PTFE |
| Dielectrics: | Topas® |

FINISHES

| | |
|-----------|--------|
| Body: | Nickel |
| Contacts: | Gold |

ELECTRICAL

| | |
|------------------|---|
| Impedance: | 75 Ohms |
| Frequency Range: | Dual Jacks: DC to 4.1 GHz |
| | Single Jacks: DC to 3.0 GHz |
| Return Loss: | Dual Jacks: -20 dB Minimum to 2.4 GHz |
| | -10 dB Minimum to 4.1 GHz |
| | Single Jacks: -20 dB Minimum to 1.5 GHz |
| | (self-terminated) -10 dB Minimum to 3.0 GHz |

MECHANICAL

| | |
|-------------------|--------------------|
| Life: | 30,000+ Cycles |
| Withdrawal Force: | 2.0 Pounds Minimum |

ENVIRONMENTAL

| | |
|----------------------|-------------------------|
| Temperature Range: | -40° C to +85° C |
| Corrosion: | MIL-STD-202, Method 101 |
| Moisture Resistance: | MIL-STD-202, Method 106 |

DUAL



FIGURE 1

SINGLE

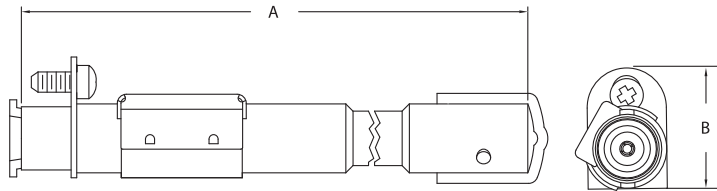
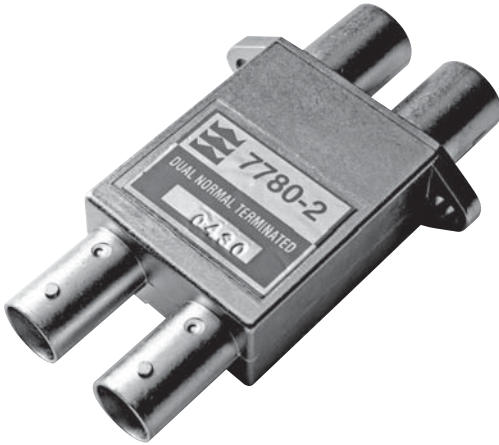

FIGURE 2

| Item Number | Military PN | Product Description | Gender | Finish | Dimensions | | | | Cable Group | Cable Procedure | Crimp Die | Mounting Hole | Figure # |
|-------------|-------------|---|--------|--------|------------|-------|-------|---|-------------|-----------------|-----------|---------------|----------|
| | | | | | A | B | C | D | | | | | |
| 7790-4 | | Mid-Size, Dual, Feed Through | F-F | Nickel | 3.375 | 0.285 | 0.081 | | | | | | 1 |
| 7790-3 | | Mid-Size, Dual, Non Terminated | F-F | Nickel | 3.375 | 0.285 | 0.081 | | | | | | 1 |
| 7790-2 | | Mid-Size, Dual, Terminated | F-F | Nickel | 3.375 | 0.285 | 0.081 | | | | | | 1 |
| 7772-2 | | Mid-Size, Single, Non Terminated, Long | F-F | Nickel | 3.389 | 0.665 | | | | | | | 2 |
| 7772-1 | | Mid-Size, Single, Non Terminated, Short | F-F | Nickel | 2.060 | 0.665 | | | | | | | 2 |
| 7772-4 | | Mid-Size, Single, Terminated, Long | F-F | Nickel | 3.389 | 0.359 | 0.665 | | | | | | 2 |
| 7772-3 | | Mid-Size, Single, Terminated, Short | F-F | Nickel | 2.060 | 0.359 | 0.665 | | | | | | 2 |

STANDARD VIDEO JACKS



- 75 Ohm Nominal Impedance – suitable for Analog, Serial Digital, and HDTV applications.
- Mates with standard BNC plugs and standard (0.090" center pin) patch plugs.
- Meets SMPTE 424M and HDTV standards.
- Terminated, un-terminated, and feed-through versions available in dual or single configurations.
- Frequency Range: Up to 3.5 GHz

SPECIFICATIONS

MATERIAL

| | |
|--------------|---------------------------|
| Body: | Zinc Alloy |
| Contacts: | Beryllium Copper or Brass |
| Springs: | Beryllium Copper |
| Insulators: | PTFE or Delrin® |
| Dielectrics: | Zytel® |

FINISHES

| | |
|------------------|--------|
| Body: | Nickel |
| Center Contacts: | Gold |

ELECTRICAL

| | |
|------------------|--|
| Impedance: | 75 Ohms |
| Frequency Range: | Dual Jacks: DC to 3.5 GHz Single Jacks: DC to 1.5 GHz |
| Return Loss: | Dual Jacks: -15 dB Minimum to 2.4 GHz -10 dB Minimum to 3.5 GHz Single Jacks: -18 dB Minimum to 750 MHz (self-terminated) -10 dB Minimum to 1.5 GHz |

MECHANICAL

| | |
|-------------------|--------------------|
| Life: | 50,000 Cycles |
| Withdrawal Force: | 3.0 Pounds Minimum |

ENVIRONMENTAL

| | |
|----------------------|--------------------------------------|
| Temperature Range: | -40° C to +85° C |
| Corrosion: | MIL-STD-202, Method 101, Condition B |
| Moisture Resistance: | MIL-STD-202, Method 106 |

DUAL

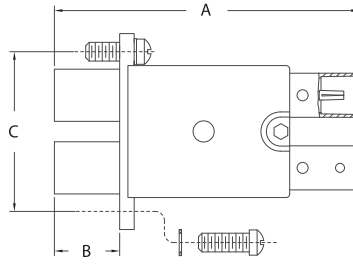

FIGURE 1

SINGLE



FIGURE 2

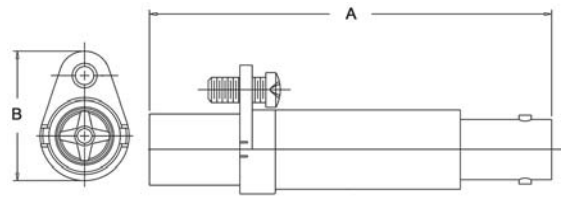

FIGURE 3

| Item Number | Military PN | Product Description | Gender | Finish | Dimensions | | | | Cable Group | Cable Procedure | Crimp Die | Mounting Hole | Figure # |
|-------------|-------------|--|--------|--------|------------|-------|-------|---|-------------|-----------------|-----------|---------------|----------|
| | | | | | A | B | C | D | | | | | |
| 7780-4 | | Standard Size, Dual, Feed Through | F-F | Nickel | 2.650 | 0.560 | | | | | | | 1 |
| 7780-7 | | Standard Size, Dual, Feed Through, Threaded Flange | F-F | Nickel | 2.650 | 0.560 | 1.380 | | | | | | 1 |
| 7780-3 | | Standard Size, Dual, Non Terminated | F-F | Nickel | 2.650 | 0.560 | 1.380 | | | | | | 1 |
| 7780-6 | | Standard Size, Dual, Non Terminated, Threaded Flange | F-F | Nickel | 2.650 | 0.560 | 1.380 | | | | | | 1 |
| 7780-2 | | Standard Size, Dual, Terminated | F-F | Nickel | 2.650 | 0.560 | 1.380 | | | | | | 1 |
| 7780-5 | | Standard Size, Dual, Terminated, Threaded Flange | F-F | Nickel | 2.650 | 0.560 | 1.380 | | | | | | 1 |
| 7520-10 | | Standard Size, Single, Terminated | F-F | Nickel | 2.540 | 0.820 | | | | | | | 2 |
| 7520-9 | | Standard Size, Single, Non Terminated | F-F | Nickel | 2.540 | 0.820 | | | | | | | 3 |

POPULATED VIDEO JACKFIELDS



- 75 Ohm Nominal Impedance – suitable for Analog, Serial Digital, and HDTV applications.
- Industry standard 19" panels pre-populated with KINGS® Brand single or dual video jacks.
- Standard size jacks available in configurations up to 28 circuits across.
- Mid-size jacks available in configurations up to 32 circuits across.
- Terminated, un-terminated, and feed-through versions available.

SPECIFICATIONS

MATERIAL

| | |
|--------------|--|
| Panels: | Smooth Black Phenolic |
| Labels: | Designation Strip with Clear Plastic Cover |
| Video Jacks: | See Specifications for Individual Products |

FEED-THROUGH PANEL - 75 OHM BNC

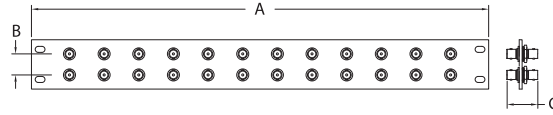

FIGURE 1

MID-SIZE

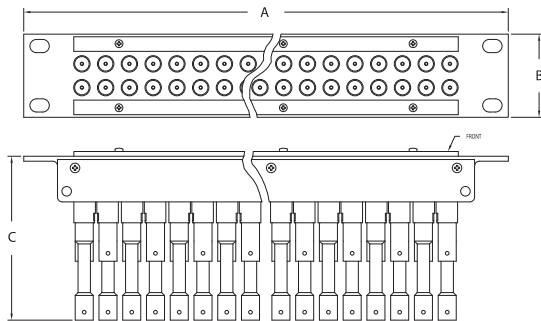

FIGURE 2

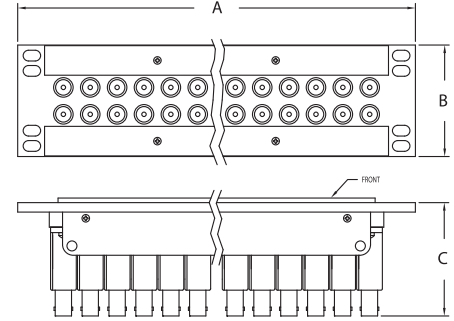

FIGURE 3

| Item Number | Military PN | Product Description | Gender | Finish | A | Dimensions B | C | D | Cable Group | Cable Procedure | Crimp Die | Mounting Hole | Figure # |
|-------------|-------------|--|--------|--------|--------|--------------|-------|---|-------------|-----------------|-----------|---------------|----------|
| 7675-2 | | 75 BNC Feed Through, Single, 1 RU x 10 | F | | 14.000 | 1.750 | 1.280 | | | | | | N/S |
| 7676-2 | | 75 BNC Feed Through, Single, 1 RU x 32 | F | | 19.000 | 1.750 | 1.280 | | | | | | N/S |
| 7675-5 | | 75 BNC Feed Through, Single, 2 RU x 40 | F | | 19.000 | 0.820 | 1.280 | | | | | | 1 |
| 7795-1 | | Mid-Size, Dual, Terminated, 1 RU x 24 | F | | 19.000 | 1.750 | 3.450 | | | | | | 2 |
| 7795-11 | | Mid-Size, Dual, Terminated, 1 RU x 30 | F | | 19.000 | 1.750 | 3.450 | | | | | | 2 |
| 7795-12 | | Mid-Size, Dual, Terminated, 1 RU x 32 | F | | 19.000 | 1.750 | 3.450 | | | | | | 2 |
| 7795-13 | | Mid-Size, Dual, Terminated, 1 RU x 34 | F | | 19.000 | 1.750 | 3.450 | | | | | | 2 |
| 7795-27 | | Mid-Size, Dual, Terminated, 4 RU x 96 | F | | 19.000 | 7.000 | 3.600 | | | | | | N/S |
| 7475-21 | | Mid-Size, Single, Patch-Through, 1RU x 32 | F | | 19.000 | 1.750 | 3.450 | | | | | | 2 |
| 7795-15 | | Mid-Size, Single, Patch-Through, 1 RU x 34 | F | | 19.000 | 1.730 | 3.390 | | | | | | 2 |
| 7475-22 | | Mid-Size, Single, Patch-Through, 1.5 RU x 32 | F | | 19.000 | 2.590 | 3.450 | | | | | | 3 |
| 7795-29 | | Mid-Size, Single, Terminated, 1.5 RU x 32 | F | | 19.000 | 2.590 | 3.600 | | | | | | 3 |
| 7795-17 | | Mid-Size, Dual, Terminated, 2 RU x 24 | F | | 19.000 | 3.500 | 3.450 | | | | | | 3 |
| 7795-14 | | Mid-Size, Dual, Terminated, 1.5 RU x 32 | F | | 19.000 | 2.590 | 3.600 | | | | | | 3 |

STANDARD SIZE

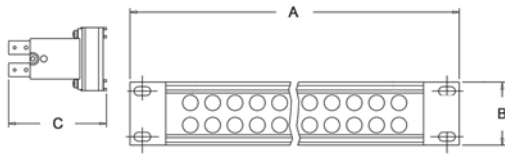

FIGURE 4

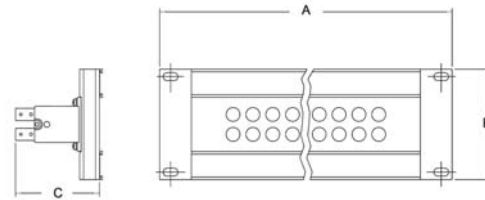

FIGURE 5

| Item Number | Military PN | Product Description | Gender | Finish | Dimensions | | | | Cable Group | Cable Procedure | Crimp Die | Mounting Hole | Figure # |
|-------------|-------------|--|--------|--------|------------|-------|-------|--------|-------------|-----------------|-----------|---------------|----------|
| | | | | | A | B | C | D | | | | | |
| 7575-45 | | Standard Size, Single, Terminated, 1.5 RU x 48 | F | | 19.000 | 2.590 | 2.540 | 15.500 | | | | | 3 |
| 7575-46 | | Standard Size, Single, Terminated, 1.5 RU x 56 | F | | 19.000 | 2.590 | 2.540 | 17.750 | | | | | 3 |
| 7785-41 | | Standard Size, Dual, Terminated, 1.5 RU x 24 | F | | 19.000 | 2.590 | 2.650 | 15.500 | | | | | 3 |
| 7785-40 | | Standard Size, Dual, Terminated, 1.5 RU x 28 | F | | 19.000 | 2.590 | 2.640 | 17.750 | | | | | 3 |
| 7785-42 | | Standard Size, Dual, Feed Through, 1 RU x 24 | F | | 19.000 | 1.750 | 2.800 | | | | | | 4 |
| 7785-29 | | Standard Size, Dual, Non Terminated, 1 RU x 24 | F | | 19.000 | 1.750 | 2.800 | | | | | | 4 |
| 7785-31 | | Standard Size, Dual, Non Terminated, 1 RU x 26 | F | | 19.000 | 1.750 | 2.800 | | | | | | 4 |
| 7785-6 | | Standard Size, Dual, Terminated, 1 RU x 24 | F | | 19.000 | 1.750 | 2.800 | | | | | | 4 |
| 7785-7 | | Standard Size, Dual, Terminated, 1 RU x 26 | F | | 19.000 | 1.750 | 2.800 | | | | | | 4 |
| 7575-13 | | Standard Size, Single, Terminated, 1 RU x 24 | F | | 19.000 | 1.750 | 2.620 | | | | | | 4 |
| 7575-24 | | Standard Size, Single, Terminated, 1 RU x 48 | F | | 19.000 | 1.750 | 2.620 | | | | | | 4 |
| 7575-47 | | Standard Size, Single, Terminated, 1 RU x 52 | F | | 19.000 | 1.750 | 2.620 | | | | | | 4 |
| 7575-21 | | Standard Size, Single, Non Terminated, 1 RU x 48 | F | | 19.000 | 1.750 | 2.620 | | | | | | 4 |
| 7785-8 | | Standard Size, Dual, Terminated, 2 RU x 24 | F | | 19.000 | 3.500 | 2.800 | | | | | | 5 |
| 7785-4 | | Standard Size, Dual, Terminated, 2 RU x 26 | F | | 19.000 | 3.500 | 2.800 | | | | | | 5 |
| 7785-5 | | Standard Size, Dual, Terminated, 2 RU x 26 | F | | 19.000 | 3.500 | 2.800 | | | | | | 5 |
| 7785-32 | | Standard Size, Dual, Non Terminated, 2 RU x 24 | F | | 19.000 | 3.500 | 2.800 | | | | | | 5 |
| 7785-30 | | Standard Size, Dual, Non Terminated, 2 RU x 26 | F | | 19.000 | 3.500 | 2.800 | | | | | | 5 |
| 7785-27 | | Standard Size, Dual, Terminated, 4 RU x 75 | F | | 19.000 | 7.000 | 2.620 | | | | | | N/S |
| 7575-18 | | Standard Size, Single, Non Terminated, 2 RU x 48 | F | | 19.000 | 3.500 | 2.800 | | | | | | 5 |
| 7575-15 | | Standard Size, Single, Terminated, 2 RU x 48 | F | | 19.000 | 3.500 | 2.620 | | | | | | 5 |
| 7575-26 | | Standard Size, Single, Terminated, 4 RU x 150 | F | | 19.000 | 7.000 | 2.620 | | | | | | N/S |



STRAIN RELIEF BOOTS

- Protects from wear, fatigue, and weather.
- Designed to fit a variety of industry-leading broadcast cables.
- Available in 10 popular colors.



KTH-1000

HAND CRIMPING TOOL

- Field-tested and approved - an industry favorite.
- Ratchet-type tool does not release until crimp is complete.
- Robust and reliable - frame made of heavy-duty, lightweight aluminum.
- Interchangeable dies available to fit a variety of connector and cable types.

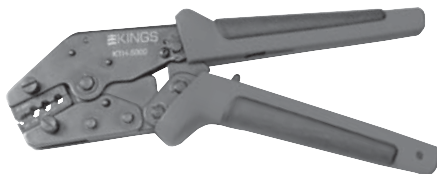

KTH-5000

HAND CRIMPING TOOL

- Economical and user-friendly alternative to other industrial crimping tools.
- Lightweight, ergonomic tool allows for one-handed operation.
- Ultra-smooth ratchet design with rubber grip handles.
- Available dies developed specifically for precise crimping of KINGS® connectors.

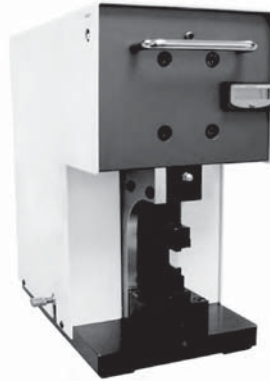

KTM-5000

PNEUMATIC CRIMPING MACHINE

- Portable, bench-mounted with no permanent lines attached.
- Designed for use with KINGS® KTH-1000 and KTH-2000 die sets.
- Ideal for long or short production runs.
- Convenient foot control frees operator hands for crimping.
- Quick and easy changing from one die to another.
- Pneumatic interlock feature guarantees constant crimping.
- Designed with OSHA safety requirements in mind.
- Low maintenance.



KTS-8-1 AND KTS-8-2

MANUAL STRIPPING TOOLS

- Hand-held tool is lightweight and compact - ideal for field use.
- Blade cassettes and memory blocks interchange quickly and easily.
- Cam adjustment ensures precise hold on cable without distorting the jacket.
- KTS-8-1 is designed specifically for the Belden 179 DT Cable.
- KTS-8-2 is adjustable for use in most two- and three-piece BNC applications.

STRAIN RELIEF BOOTS



FIGURE 1



FIGURE 2

| Item Number | Military PN | Product Description | Gender | Finish | Dimensions | | | | Cable Group | Cable Procedure | Crimp Die | Mounting Hole | Figure # |
|--------------|-------------|------------------------------|--------|--------|------------|-------|-------|---|-------------|-----------------|-----------|---------------|----------|
| | | | | | A | B | C | D | | | | | |
| 1-8065-1 | | Boot for 735 Cable, Brown | | | 1.520 | 0.442 | 0.324 | | 31 | | | | 1 |
| 1-8065-2 | | Boot for 735 Cable, Red | | | 1.520 | 0.442 | 0.324 | | 31 | | | | 1 |
| 1-8065-3 | | Boot for 735 Cable, Orange | | | 1.520 | 0.442 | 0.324 | | 31 | | | | 1 |
| 1-8065-4 | | Boot for 735 Cable, Yellow | | | 1.520 | 0.442 | 0.324 | | 31 | | | | 1 |
| 1-8065-5 | | Boot for 735 Cable, Green | | | 1.520 | 0.442 | 0.324 | | 31 | | | | 1 |
| 1-8065-6 | | Boot for 735 Cable, Blue | | | 1.520 | 0.442 | 0.324 | | 31 | | | | 1 |
| 1-8065-7 | | Boot for 735 Cable, Violet | | | 1.520 | 0.442 | 0.324 | | 31 | | | | 1 |
| 1-8065-8 | | Boot for 735 Cable, Grey | | | 1.520 | 0.442 | 0.324 | | 31 | | | | 1 |
| 1-8065-9 | | Boot for 735 Cable, White | | | 1.520 | 0.442 | 0.324 | | 31 | | | | 1 |
| 1-8065-10 | | Boot for 735 Cable, Black | | | 1.520 | 0.442 | 0.324 | | 31 | | | | 1 |
| 1-8066-1 | | Boot for 734 Cable, Brown | | | 1.520 | 0.442 | 0.324 | | 30 | | | | 1 |
| 1-8066-2 | | Boot for 734 Cable, Red | | | 1.520 | 0.442 | 0.324 | | 30 | | | | 1 |
| 1-8066-3 | | Boot for 734 Cable, Orange | | | 1.520 | 0.442 | 0.324 | | 30 | | | | 1 |
| 1-8066-4 | | Boot for 734 Cable, Yellow | | | 1.520 | 0.442 | 0.324 | | 30 | | | | 1 |
| 1-8066-5 | | Boot for 734 Cable, Green | | | 1.520 | 0.442 | 0.324 | | 30 | | | | 1 |
| 1-8066-6 | | Boot for 734 Cable, Blue | | | 1.520 | 0.442 | 0.324 | | 30 | | | | 1 |
| 1-8066-7 | | Boot for 734 Cable, Violet | | | 1.520 | 0.442 | 0.324 | | 30 | | | | 1 |
| 1-8066-8 | | Boot for 734 Cable, Grey | | | 1.520 | 0.442 | 0.324 | | 30 | | | | 1 |
| 1-8066-9 | | Boot for 734 Cable, White | | | 1.520 | 0.442 | 0.324 | | 30 | | | | 1 |
| 1-8066-10 | | Boot for 734 Cable, Black | | | 1.520 | 0.442 | 0.324 | | 30 | | | | 1 |
| 1-8114-1 QD | | Boot for 1694A Cable, Brown | | | 1.540 | 0.460 | 0.390 | | 25 | | | | 1 |
| 1-8114-2 QD | | Boot for 1694A Cable, Red | | | 1.540 | 0.460 | 0.390 | | 25 | | | | 1 |
| 1-8114-3 QD | | Boot for 1694A Cable, Orange | | | 1.540 | 0.460 | 0.390 | | 25 | | | | 1 |
| 1-8114-4 QD | | Boot for 1694A Cable, Yellow | | | 1.540 | 0.460 | 0.390 | | 25 | | | | 1 |
| 1-8114-5 QD | | Boot for 1694A Cable, Green | | | 1.540 | 0.460 | 0.390 | | 25 | | | | 1 |
| 1-8114-6 QD | | Boot for 1694A Cable, Blue | | | 1.540 | 0.460 | 0.390 | | 25 | | | | 1 |
| 1-8114-7 QD | | Boot for 1694A Cable, Violet | | | 1.540 | 0.460 | 0.390 | | 25 | | | | 1 |
| 1-8114-8 QD | | Boot for 1694A Cable, Grey | | | 1.540 | 0.460 | 0.390 | | 25 | | | | 1 |
| 1-8114-9 QD | | Boot for 1694A Cable, White | | | 1.540 | 0.460 | 0.390 | | 25 | | | | 1 |
| 1-8114-10 QD | | Boot for 1694A Cable, Black | | | 1.540 | 0.460 | 0.390 | | 25 | | | | 1 |
| 1-8115-1 QD | | Boot for 1855A Cable, Brown | | | 1.540 | 0.460 | 0.347 | | 26 | | | | 1 |
| 1-8115-2 QD | | Boot for 1855A Cable, Red | | | 1.540 | 0.460 | 0.347 | | 26 | | | | 1 |
| 1-8115-3 QD | | Boot for 1855A Cable, Orange | | | 1.540 | 0.460 | 0.347 | | 26 | | | | 1 |
| 1-8115-4 QD | | Boot for 1855A Cable, Yellow | | | 1.540 | 0.460 | 0.347 | | 26 | | | | 1 |
| 1-8115-5 QD | | Boot for 1855A Cable, Green | | | 1.540 | 0.460 | 0.347 | | 26 | | | | 1 |
| 1-8115-6 QD | | Boot for 1855A Cable, Blue | | | 1.540 | 0.460 | 0.347 | | 26 | | | | 1 |

| Item Number | Military PN | Product Description | Gender | Finish | Dimensions | | | | Cable Group | Cable Procedure | Crimp Die | Mounting Hole | Figure # |
|--------------|-------------|--------------------------------------|--------|--------|------------|-------|-------|---|-------------|-----------------|-----------|---------------|----------|
| | | | | | A | B | C | D | | | | | |
| 1-8115-7 QD | | Boot for 1855A Cable, Violet | | | 1.540 | 0.460 | 0.347 | | 26 | | | | 1 |
| 1-8115-8 QD | | Boot for 1855A Cable, Grey | | | 1.540 | 0.460 | 0.347 | | 26 | | | | 1 |
| 1-8115-9 QD | | Boot for 1855A Cable, White | | | 1.540 | 0.460 | 0.347 | | 26 | | | | 1 |
| 1-8115-10 QD | | Boot for 1855A Cable, Black | | | 1.540 | 0.460 | 0.347 | | 26 | | | | 1 |
| 1-8574-1 | | Boot for 179DT Cable, Brown | | | 1.520 | 0.442 | 0.324 | | 23 | | | | 1 |
| 1-8574-2 | | Boot for 179DT Cable, Red | | | 1.520 | 0.442 | 0.324 | | 23 | | | | 1 |
| 1-8574-3 | | Boot for 179DT Cable, Orange | | | 1.520 | 0.442 | 0.324 | | 23 | | | | 1 |
| 1-8574-4 | | Boot for 179DT Cable, Yellow | | | 1.520 | 0.442 | 0.324 | | 23 | | | | 1 |
| 1-8574-5 | | Boot for 179DT Cable, Green | | | 1.520 | 0.442 | 0.324 | | 23 | | | | 1 |
| 1-8574-6 | | Boot for 179DT Cable, Blue | | | 1.520 | 0.442 | 0.324 | | 23 | | | | 1 |
| 1-8574-7 | | Boot for 179DT Cable, Violet | | | 1.520 | 0.442 | 0.324 | | 23 | | | | 1 |
| 1-8574-8 | | Boot for 179DT Cable, Grey | | | 1.520 | 0.442 | 0.324 | | 23 | | | | 1 |
| 1-8574-9 | | Boot for 179DT Cable, White | | | 1.520 | 0.442 | 0.324 | | 23 | | | | 1 |
| 1-8574-10 | | Boot for 179DT Cable, Black | | | 1.520 | 0.442 | 0.324 | | 23 | | | | 1 |
| 1-8575-1 QD | | Boot for RG-174 Cable, Brown | | | 1.520 | 0.442 | 0.324 | | B1 | | | | 1 |
| 1-8575-2 QD | | Boot for RG-174 Cable, Red | | | 1.520 | 0.442 | 0.324 | | B1 | | | | 1 |
| 1-8575-3 QD | | Boot for RG-174 Cable, Orange | | | 1.520 | 0.442 | 0.324 | | B1 | | | | 1 |
| 1-8575-4 QD | | Boot for RG-174 Cable, Yellow | | | 1.520 | 0.442 | 0.324 | | B1 | | | | 1 |
| 1-8575-5 QD | | Boot for RG-174 Cable, Green | | | 1.520 | 0.442 | 0.324 | | B1 | | | | 1 |
| 1-8575-6 QD | | Boot for RG-174 Cable, Blue | | | 1.520 | 0.442 | 0.324 | | B1 | | | | 1 |
| 1-8575-7 QD | | Boot for RG-174 Cable, Violet | | | 1.520 | 0.442 | 0.324 | | B1 | | | | 1 |
| 1-8575-8 QD | | Boot for RG-174 Cable, Grey | | | 1.520 | 0.442 | 0.324 | | B1 | | | | 1 |
| 1-8575-9 QD | | Boot for RG-174 Cable, White | | | 1.520 | 0.442 | 0.324 | | B1 | | | | 1 |
| 1-8575-10 QD | | Boot for RG-174 Cable, Black | | | 1.520 | 0.442 | 0.324 | | B1 | | | | 1 |
| 1-8576-1 QD | | Boot for RG-58 Cable, Brown | | | 1.520 | 0.442 | 0.324 | | D | | | | 1 |
| 1-8576-2 QD | | Boot for RG-58 Cable, Red | | | 1.520 | 0.442 | 0.324 | | D | | | | 1 |
| 1-8576-3 QD | | Boot for RG-58 Cable, Orange | | | 1.520 | 0.442 | 0.324 | | D | | | | 1 |
| 1-8576-4 QD | | Boot for RG-58 Cable, Yellow | | | 1.520 | 0.442 | 0.324 | | D | | | | 1 |
| 1-8576-5 QD | | Boot for RG-58 Cable, Green | | | 1.520 | 0.442 | 0.324 | | D | | | | 1 |
| 1-8576-6 QD | | Boot for RG-58 Cable, Blue | | | 1.520 | 0.442 | 0.324 | | D | | | | 1 |
| 1-8576-7 QD | | Boot for RG-58 Cable, Violet | | | 1.520 | 0.442 | 0.324 | | D | | | | 1 |
| 1-8576-8 QD | | Boot for RG-58 Cable, Grey | | | 1.520 | 0.442 | 0.324 | | D | | | | 1 |
| 1-8576-9 QD | | Boot for RG-58 Cable, White | | | 1.520 | 0.442 | 0.324 | | D | | | | 1 |
| 1-8576-10 QD | | Boot for RG-58 Cable, Black | | | 1.520 | 0.442 | 0.324 | | D | | | | 1 |
| 1-8577-1 QD | | Boot for RG-59 Cable, Brown | | | 1.540 | 0.460 | 0.359 | | G1 | | | | 1 |
| 1-8577-2 QD | | Boot for RG-59 Cable, Red | | | 1.540 | 0.460 | 0.359 | | G1 | | | | 1 |
| 1-8577-3 QD | | Boot for RG-59 Cable, Orange | | | 1.540 | 0.460 | 0.359 | | G1 | | | | 1 |
| 1-8577-4 QD | | Boot for RG-59 Cable, Yellow | | | 1.540 | 0.460 | 0.359 | | G1 | | | | 1 |
| 1-8577-5 QD | | Boot for RG-59 Cable, Green | | | 1.540 | 0.460 | 0.359 | | G1 | | | | 1 |
| 1-8577-6 QD | | Boot for RG-59 Cable, Blue | | | 1.540 | 0.460 | 0.359 | | G1 | | | | 1 |
| 1-8577-7 QD | | Boot for RG-59 Cable, Violet | | | 1.540 | 0.460 | 0.359 | | G1 | | | | 1 |
| 1-8577-8 QD | | Boot for RG-59 Cable, Grey | | | 1.540 | 0.460 | 0.359 | | G1 | | | | 1 |
| 1-8577-9 QD | | Boot for RG-59 Cable, White | | | 1.540 | 0.460 | 0.359 | | G1 | | | | 1 |
| 1-8577-10 QD | | Boot for RG-59 Cable, Black | | | 1.540 | 0.460 | 0.359 | | G1 | | | | 1 |
| 1-8603 | | Right Angle Boot for 735 Cable, Blue | | | 1.710 | 1.420 | 0.470 | | 31 | | | | 2 |

INSTALLATION TOOLS



FIGURE 1

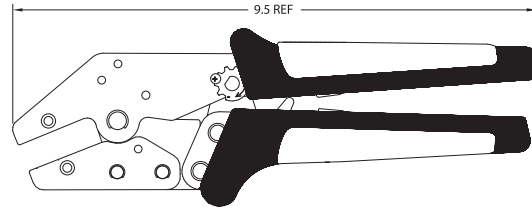

FIGURE 2



FIGURE 3

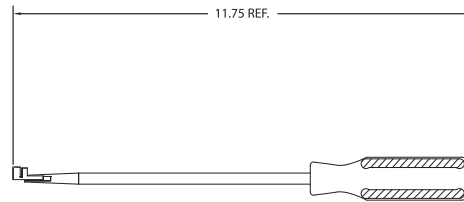

FIGURE 4



FIGURE 5

| Item Number | Military PN | Product Description | Gender | Finish | Dimensions | | | | Cable Group | Cable Procedure | Crimp Die Sets | Figure # |
|-------------|-------------|--|--------|--------|------------|---|---|---|-------------|----------------------|----------------|----------|
| | | | | | A | B | C | D | | | | |
| KTH-1000 | | Crimping Tool, Manual | | | | | | | | KTH-1000 or KTH-2000 | 1 | |
| KTH-5000 | | Crimping Tool, Manual | | | | | | | | KTH-5000 | 2 | |
| KTM-5000 | | Crimping Tool, Pneumatic | | | | | | | | KTH-1000 or KTH-2000 | 3 | |
| KTW-13 | | Miniature A/V Insertion and Removal Tool | | | | | | | | | 4 | |
| KTS-8-1 | | Stripping Tool, Manual, 179DT Cable | | | | | | | | | 5 | |
| KTS-8-2 | | Stripping Tool, Manual, Adjustable | | | | | | | | | 5 | |

SPLICES

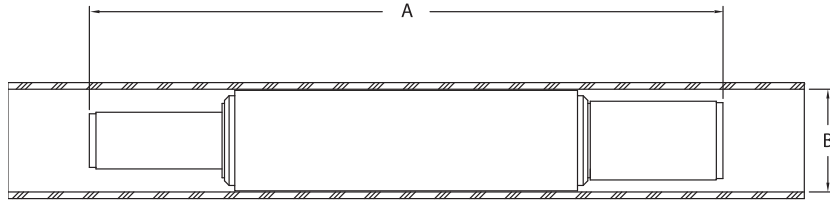

FIGURE 1

| Item Number | Military PN | Product Description | Gender | Finish | Dimensions | | | | Cable Group | Cable Procedure | Crimp Die | Mounting Hole | Figure # |
|-------------|-------------|-----------------------|--------|--------|------------|-------|---|---|-------------|-----------------|----------------------|---------------|----------|
| | | | | | A | B | C | D | | | | | |
| 3050-10-9 | | Cable Splice, 735-734 | NONE | Nickel | 2.400 | 0.390 | | | 30,31 | 3-661-5 | KTH-2185 KTH-2186 | | 1 |
| 3050-11-9 | | Cable Splice, 735-735 | NONE | Nickel | 2.400 | 0.390 | | | 31 | 3-661-5 | KTH-2185 | | 1 |
| 3050-12-9 | | Cable Splice, 734-734 | NONE | Nickel | 2.400 | 0.390 | | | 30 | 3-661-5 | KTH-2186 | | 1 |

MOUNTING HOLES



MOUNTING HOLE A

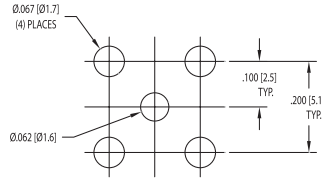

MOUNTING HOLE B

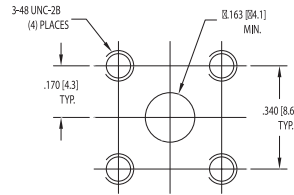

MOUNTING HOLE C

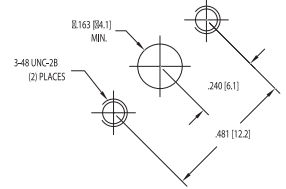

MOUNTING HOLE D



MOUNTING HOLE E

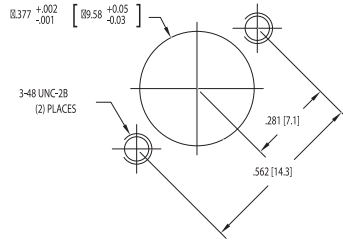

MOUNTING HOLE F



MOUNTING HOLE G



MOUNTING HOLE H

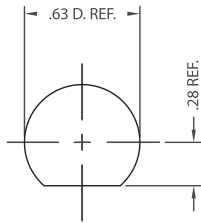

MOUNTING HOLE I



MOUNTING HOLE J

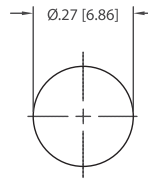

MOUNTING HOLE K

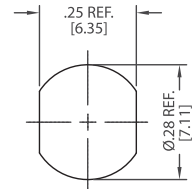

MOUNTING HOLE L

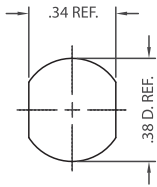

MOUNTING HOLE M



MOUNTING HOLE N

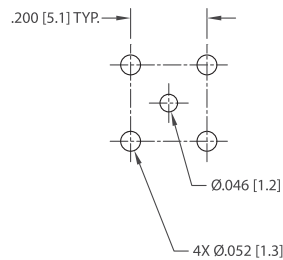

MOUNTING HOLE O

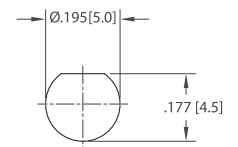

MOUNTING HOLE P



MOUNTING HOLE Q

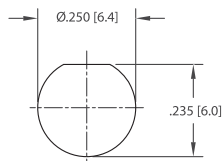

MOUNTING HOLE R

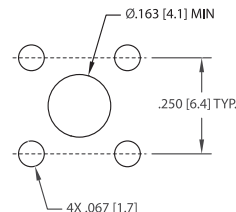

MOUNTING HOLE S

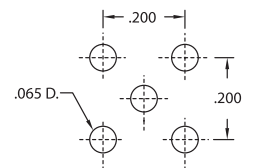

MOUNTING HOLE T



MOUNTING HOLE U



MOUNTING HOLE V



MOUNTING HOLE W



MOUNTING HOLE X



MOUNTING HOLE Y



MOUNTING HOLE Z



MOUNTING HOLE AA



MOUNTING HOLE AB



MOUNTING HOLE AC

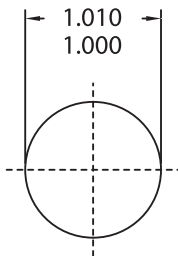

MOUNTING HOLE AD

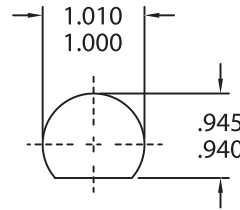

MOUNTING HOLE AE



MOUNTING HOLE AF



MOUNTING HOLE AG



MOUNTING HOLE AH



MOUNTING HOLE AI

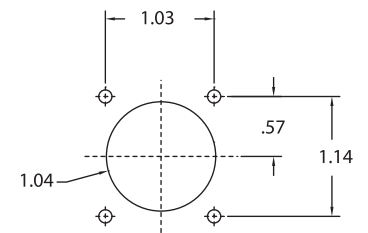

MOUNTING HOLE AJ



MOUNTING HOLE AK



MOUNTING HOLE AL

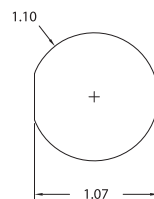

MOUNTING HOLE AM

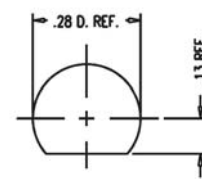

MOUNTING HOLE AN

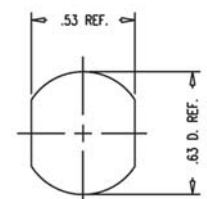

MOUNTING HOLE AO



1. WITH CLAMP NUT, SLIP WASHER & GASKET ON CABLE, REMOVE JACKET TO $.375 \pm .015$ DIM.
 2. SLIDE BRAID CLAMP OVER BRAID AGAINST JACKET EDGE. COMB OUT BRAID WIRES, FOLD BACK OVER BRAID CLAMP & TRIM AS SHOWN.
 3. REMOVE DIELECTRIC TO $.045 \pm .005$ DIM. & TRIM CENTER CONDUCTOR TO $.218 \pm .015$ DIM.
 4. SLIDE WASHER OVER DIELECTRIC & AGAINST BRAID. PLACE THICK INSULATOR ON CONTACT & ASSEMBLE ON CABLE CENTER CONDUCTOR WITH DIELECTRIC BOTTOMED IN C'BORE AND SOLDER CONTACT IN POSITION. (DO NOT OVERHEAT)
 5. ASSEMBLE THIN INSULATOR ON CONTACT WITH C'BORE TOWARD CONTACT TIP & THREAD ASSEMBLY SECURELY INTO CONNECTOR BODY.
- RECOMMENDED TORQUE: 55-60 IN. LBS.

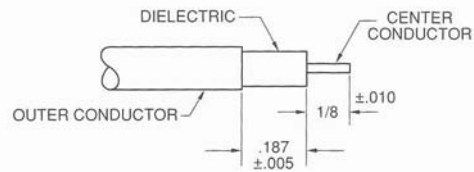

1. Remove outer conductor and dielectric to dimensions shown. (Care must be taken to remove all metal particles from dielectric surfaces.)

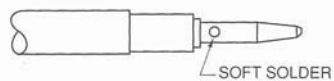

2. Assemble center contact in position against dielectric face & soft solder.

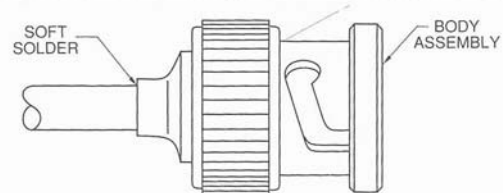

3. Place solder preform on cable, insert cable into body assembly until bottomed, hold in place and solder. (Apply a small amount of non-acid flux and heat at point directly behind body assembly on outer conductor.)





1. Cut cable end square, slide shrink tubing and K-grip sleeve over jacket and with jacket trim jig make cuts 1 and 2 in jacket.



2. Remove jacket to dimension "A", flare or bluge back braid and trim with scissors at edge of jacket.



3. Remove jacket to dimension "B."



4. Using dielectric trim jig, trim dimension "C." Exposed center conductor length will be equal to dimension "D" of trim code.



5. Place cable seal gasket over center conductor against dielectric then solder contact to center conductor. Gasket must be under compression after soldering is completed.

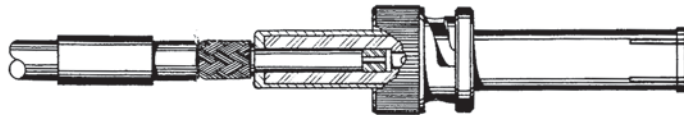

6. Push connector over dielectric and under braid until contact bottoms in insulator.

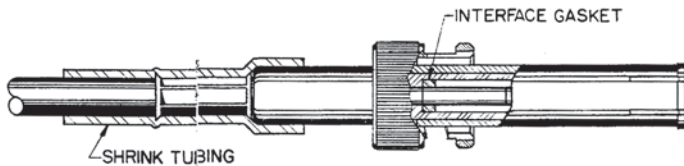

7. Slide K-grip sleeve over K-grip and braid to within 1/64 inch of shoulder of body and form hex. Then place tubing in position and shrink onto body and cable by heating (300°F Max). Install interface gasket over contact. (When Supplied) When Weatherproof Sleeve is used Heat Shrink Tubing is not required.

UNLESS OTHERWISE SPECIFIED:

- 1. TOLERANCES: FRACTIONS ± .010 DECIMALS ± .004 ANGLES ± 0° 30'
- 2. REMOVE ALL BURRS, BREAK SHARP EDGES .005 MAX.
- 3. NO FILLETS PERMITTED.
- 4. SURFACE ROUGHNESS 63 MICROINCHES RMS MAX.
- 5. ALL DIMENSIONS PRIOR TO PLATING.
- T. I. R. CONCENTRICITY OF ANY 2 DIAMETERS MAY NOT EXCEED THE SUM OF THEIR TOLERANCES.

| DASH NO. | TRIM CODE | TRIM DIMENSIONS | | | |
|----------|-----------|-----------------|------|-------|-------|
| | | A | B | C | D |
| -1 | CP474 | 15/16 | 3/16 | .890 | 15/64 |
| -2 | CP475 | 1 3/4 | 3/16 | 1.627 | 5/16 |
| -3 | CP476 | 2 35/64 | 3/16 | 2.415 | 5/16 |
| -4 | CP489 | 1 | 3/16 | .948 | 15/64 |

STEP 1. Prepare cable as shown in Figure 1. Cable end must be square. If it is not, use hacksaw to make new cut. Wrap tape around cable to guide jacketing cut. Remove jacket with knife. Cut off outer conductor and foam with hacksaw. Do not damage inner conductor. Use file to remove burrs and chamfer end of inner conductor. Clean exposed inner conductor of foam particles with garnet cloth. Wire brush copper particles from foam.



STEP 2. Place boot and clamping nut on cable with opening of boot toward cable end. See Figure 2. Secure clamping nut in place with tape, exposing outer conductor to dimension shown. Cut tabs into outer conductor to depth and intervals shown. Use mallet to tap knife. Use clamping nut as stop for knife.



STEP 3. Turn tabs up 90 degrees with point of knife as shown in Figure 3. Remove tape from clamping nut.



STEP 4. Cut off foam flush with flared outer conductor. Do not cut into inner conductor. See Figure 4. Remove all copper particles from foam.



STEP 5. Add flare ring and outer body as shown in Figure 5. Screw outer body to clamping nut and tighten to compress flared tabs against clamping nut. Turn outer body only; do not turn clamping nut. Disassemble connector and inspect flare for regularity and tightness to clamping nut.



STEP 6. Seat inner connector assembly and flare ring into outer body. Refer to Figure 6. Inner assembly must be fully inserted into outer body as indicated by dotted lines.



STEP 7. Slide outer body onto inner connector and screw it to clamping nut. Tighten connection. Turn outer body only; do not turn clamping nut. See Figure 7.



STEP 8. Place boot over assembly and seat it in groove of outer body. Refer to assembled connector in Figure 8.





USING A KNIFE AND Mallet MAKE 6 CUTS IN THE CABLE. MAKE THE CUTS BY PLACING THE KNIFE AGAINST THE CENTER CONDUCTOR AND CUTTING TOWARD AND UP TO THE CLAMP NUT FACE. MAKE 2 PARALLEL CUTS, ONE ON EACH SIDE OF THE CENTER CONDUCTOR AND THEN MAKE 4 MORE CUTS AT 60 DEG. TO THE FIRST TWO CUTS AS SHOWN. WITH THE TIP OF THE KNIFE BEND EACH OF THE SECTIONS OF THE OUTER CONDUCTOR FORWARD. TAP SECTIONS AGAINST CLAMP NUT WITH Mallet AND 1/4 INCH NON-METALLIC ROD. DO NOT FLATTEN TABS, REDUCING MATERIAL THICKNESS. TRIM EXCESS TAB MATERIAL FLUSH WITH OUTER DIAMETER OF CLAMP NUT.

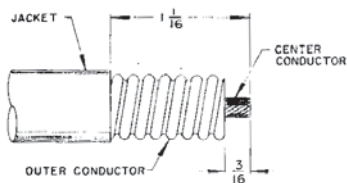

CUT CABLE END SQUARE. TRIM JACKET TO 1/16 DIM. TAKING CARE THAT JACKET END IS SQUARE. CUT OUTER CONDUCTOR AND FOAM DIELECTRIC TO 3/16 DIM. CAREFUL NOT TO NICK CENTER CONDUCTOR.

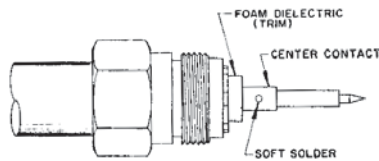

TIN CENTER CONDUCTOR AND ROUND OFF END. SLIDE CENTER CONTACT ONTO CENTER CONDUCTOR AND AGAINST DIELECTRIC. SOLDER IN PLACE, BEING CAREFUL NOT TO APPLY EXCESS HEAT AND NOT TO PUSH CONTACT INTO FOAM DIELECTRIC. TRIM DIELECTRIC FLUSH WITH FACE OF OUTER CONDUCTOR.



SLIDE GASKET ONTO OUTER CONDUCTOR AS SHOWN. APPLY A THIN COATING OF SILICONE GREASE TO OUTSIDE OF GASKET AND INSIDE SURFACE OF CLAMP NUT.

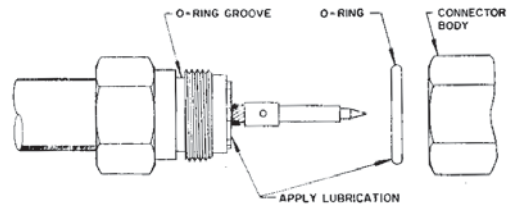

REMOVE ALL COPPER PARTICLES FROM DIELECTRIC AND SEAL EXPOSED DIELECTRIC WITH SILICONE GREASE. APPLY SILICONE GREASE TO O-RING AND INSTALL IN GROOVE ON CLAMP NUT. THREAD CONNECTOR BODY ONTO CLAMP NUT AND TIGHTEN SECURELY MAKING SURE THE CLAMP NUT IS HELD STATIONARY.

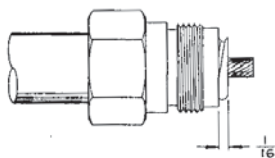

THREAD CLAMP NUT ONTO CONDUCTOR UNTIL OUTER CONDUCTOR IS EXPOSED 1/16.

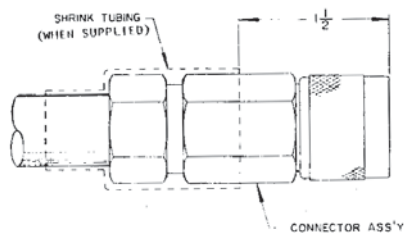

SLIDE SHRINK TUBING OVER ASSEMBLED CONNECTOR AS SHOWN AND APPLY JUST ENOUGH HEAT TO SHRINK TUBING TO OBTAIN A TIGHT SEAL. DO NOT OVERHEAT.



1. CUT CABLE END SQUARE & SCORE OUTER CONDUCTOR ALL AROUND TO DIMENSION SHOWN.

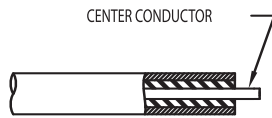

2. REMOVE JACKET TO SCORED MARK. THEN REMOVE DIELECTRIC TO FRONT FACE OF OUTER CONDUCTOR MAKING SURE SURFACE IS SQUARE & FREE OF BURRS. DO NOT NICK CENTER CONDUCTOR.

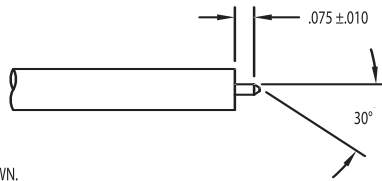

3. CHAMFER CENTER TO 30° AS SHOWN.

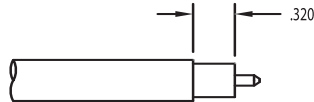

3A. WHEN USING T-FLEX402HF CABLE: SOLDER DIP CABLE PER SHEET 2 OF 3-648. BEFORE STARTING TO TRIM CABLE. TRIM JACKET TO DIMENSION SHOWN.

4. STEPS 1 THRU 3 MAY BE ACCOMPLISHED WITH EASE AND ACCURACY USING KINGS KTO-2 STRIPPING TOOL FOR RG-402/U (.141) CABLE.



5. POSITION BODY ON CABLE SO THAT FRONT FACES OF BODY & TRIMMED CABLE ARE FLUSH. HOLDING BODY IN PLACE, SOLDER OUTER CONDUCTOR TO BODY BY APPLYING HEAT TO OUTER CONDUCTOR NEAR THE BACK OF THE BODY.

6. REMOVE ANY EXCESS DIELECTRIC THAT MAY EXTRUDE FROM CABLE DUE TO HEAT SO THAT DIELECTRIC IS FLUSH AGAIN WITH OUTER CONDUCTOR OF CABLE & CONNECTOR BODY.



7. ASSEMBLE GASKET ON BODY AND C-RING INTO GROOVE. COMPRESS C-RING WITH COMPRESSING TOOL (KINGS KTC-1) AND SNAP COUPLING NUT IN PLACE.





1. CUT CABLE END SQUARE. SLIDE K-GRIP SLEEVE OVER JACKET AND MAKE CUTS 1 AND 2 THROUGH JACKET ONLY.
2. REMOVE END OF JACKET UP TO CUT 2, FLARE OR BULGE BACK BRAID AND TRIM WITH SCISSORS AT EDGE OF JACKET.
3. REMOVE JACKET BETWEEN CUTS 1 AND 2 EXPOSING .218 ±.010 LENGTH OF BRAID.
4. TRIM DIELECTRIC TO .468 ±.010 DIM., EXPOSED CENTER CONDUCTOR WILL BE .109 REF.
5. PLACE CENTER CONTACT ON CABLE AGAINST DIELECTRIC AND CRIMP OR SOLDER IN PLACE.
6. PUSH K-GRIP JR. OVER DIELECTRIC AND UNDER BRAID UNTIL DIELECTRIC BOTTOMS IN CONNECTOR.
7. SLIDE K-GRIP SLEEVE OVER K-GRIP JR. AND BRAID TO SHOULDER OF BODY ASSEMBLY AND FORM HEX USING APPLICABLE CRIMP TOOL AND DIE.



| MILITARY PART NO. | KINGS PART NO. | PIECE PART DIMS | | | * KINGS DIE SIZE |
|-------------------|----------------|-----------------|------|------|------------------|
| | | A | B | C | |
| M39012/20-0002 | KC-59-197 | .207 | .042 | .122 | 2061 |
| M39012/20-0003 | KC-59-246 | .220 | | | |



1. Trim cable to dimension shown. Recommended tooling: KTO-3A (ROTO-STRIP) for .085 S.R. Cable or KTO-2A (ROTO-STRIP) for .141 S.R. Cable.



2. Point cable as shown. Recommended tooling KTO-3A (ROTO-STRIP) .085 S.R. or KTO-2A (ROTO-STRIP) .141 S.R.

3. Insert cable into connector making sure cable seats against internal shoulder of body.

4. Solder cable onto body as shown.

| S/R CABLE | A | B |
|-----------|------|------|
| .086 | .065 | .070 |
| | .075 | |
| .141 | .080 | .085 |
| | .090 | |



1. Cut cable end square. Trim jacket, and outer shield to dimensions shown. Secure shield ends with "scotch" tape.



2. Slide nut ass'y over outer shield, butting internal shoulder against jacket edge. Remove "scotch" tape and flare outer shield against nut ass'y internal taper (Fig. 2). Trim interlayer to 7/32" dim. and secure inner shield ends with "scotch" tape.

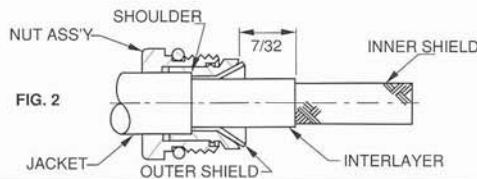

3. Slide clamp ass'y over interlayer and inner shield pressing it back firmly against outer shield and remove tape (Fig. 3). Comb out inner shield, fold back as shown (Fig. 3) and trim to 1/32" dim. Assemble washer over dielectric against inner shield. Trim dielectric and center conductor to 5/16" and 3/32" dimensions.



4. Place contact ass'y over dielectric and center conductor. Butt against washer and solder contact to center conductor as shown (Fig. 4). Assemble front insulator and intermediate contact.

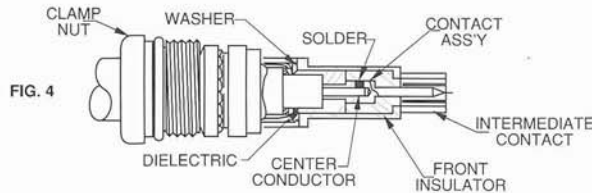

5. Insert parts into body ass'y and tighten clamp nut securely. Recommended torque 30-35 in./lbs.



1. Cut cable end square. Trim cable as shown in Fig. 1 and secure braid with scotch "magic" tape.

2. Insert cable into nut ass'y butting jacket edge against internal shoulder. Remove tape and flare braid against nut ass'y internal taper. Slide clamp ass'y over dielectrics and fillers pressing firmly against flared braid as shown in Fig. 2.

3. Trim inner conductor A to 3/16 and fold back over clamp ass'y (Fig. 2). Trim inner conductor B to 9/32 (Fig. 2).



4. Place contact ass'y over dielectric and inner conductor B and solder contact to inner conductor B as shown in Fig. 3.



5. Place front insulator on center contact and assemble intermediate contact pressing inner conductor A against clamp ass'y as in Fig. 4



6. Insert parts into body ass'y and tighten clamp nut securely. Recommended torque 30-35 inch-pounds.



CUT CABLE END SQUARE AND SLIDE CRIMP SLEEVE OVER CABLE AS SHOWN.



REMOVE JACKET TO "A" DIMENSION

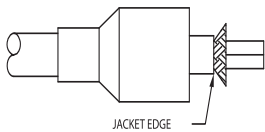

FLARE OR BULGE BACK BRAID AND TRIM WITH SCISSORS AT EDGE OF JACKET

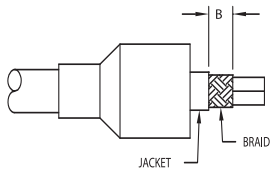

REMOVE JACKET TO "B" DIMENSION, TAKING CARE NOT TO NICK BRAID.



FOLD BACK BRAID AND TRIM BOTH FILLERS FLUSH WITH FOLD. THEN CUT THRU BOTH DIELECTRICS. AT "D" DIMENSION (DO NOT NICK CONDUCTORS AND DO NOT REMOVE DIELECTRICS). NEXT, TRIM ONE OF THE LEADS TO THE "E" DIMENSION, THE REMAINING LONG LEAD WILL BE INSERTED INTO THE CENTER CONTACT IN THE NEXT STEP.

| DASH NO | A | B | C | D | E | UNITS |
|---------|------|------|------|------|------|-------|
| -1 | .350 | .375 | .410 | .315 | .172 | IN. |
| | 8.9 | 9.5 | 10.4 | 8.0 | 4.4 | mm |



REMOVE THE DIELECTRICS AND INSERT CENTER CONDUCTORS (LONG LEAD IN CENTER, SHORT LEAD IN CONTACT BODY) INTO CONTACT ASSY. A GENTLE ROCKING MOTION OF THE CABLE WILL FACILITATE ENTRY OF THE LEADS.

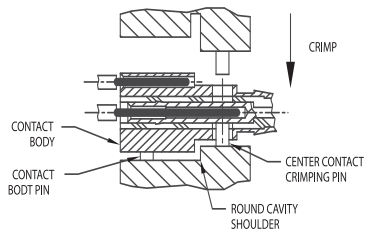

PLACE APPROPRIATE CRIMP DIE INTO CRIMPING TOOL. INSERT CONTACT ASSEMBLY, WITH CABLE CONDUCTORS IN PLACE, AGAINST THE ROUND DIE CAVITY SHOULDER. LINE UP CENTER CONTACT CRIMPING PINS WITH CLEARANCE HOLES (MAKE SURE THAT THE CONDUCTOR INSERTED IN THE CONTACT BODY IS IN LINE WITH THE CONTACT BODY PIN). CRIMP CAREFULLY.



SLIDE U-SHAPED INSULATOR INTO GAP BETWEEN CONTACT ASSEMBLY AND BRAID. USING INSULATOR SNAP IN CONTACT ASSEMBLY INTO K-GRIP BODY.



FOLD BRAID BACK OVER K-GRIP BODY. SLIDE CRIMP SLEEVE OVER BRAID AND BODY. CRIMP WITH HEX CAVITY OF DIE.



STEP 1.
CUT CABLE END SQUARE, SLIDE K-GRIP SLEEVE OVER JACKET. (CAUTION: WHEN USING A SINGLE STEP W/P SLEEVE, SLIDE SMALL END OVER CABLE FIRST AS SHOWN, SEE STEP 1A.) WITH JACKET TRIM JIG MAKE CUTS 1 AND 2 IN JACKET.

STEP 2.
REMOVE JACKET TO DIMENSION "A". FLARE OR BULGE BACK OUTER BRAID, (FLAT STRIP BRAID AND FOIL WRAP WHEN APPLICABLE) AND TRIM AT EDGE OF JACKET.

STEP 3.
REMOVE JACKET TO DIMENSION "B".

STEP 4. (FOR CABLES WITH FOIL WRAP)
FOLD BACK OUTER BRAID (OR IN SOME CASES FLAT STRIP BRAID) AT JACKET SHOULDER AND REMOVE FOIL WRAP. BE SURE NOT TO DAMAGE EITHER BRAID WHEN REMOVING FOIL WRAP. FOLD DOWN BRAID BACK IN PLACE OVER DIELECTRIC TAKING CARE TO LEAVE STRANDS IN PLACE AS MUCH AS POSSIBLE.

STEP 5.
USING DIELECTRIC TRIM JIG, TRIM DIMENSION "C". EXPOSED CENTER CONDUCTOR LENGTH WILL BE EQUAL TO DIMENSION "D" OF TRIM CODE

STEP 6.
BOTTOM CONTACT AGAINST DIELECTRIC. SOLDER OR CRIMP CONTACT TO CENTER CONDUCTOR.

STEP 7.
FLARE OUTER BRAID (AND FLAT STRIP BRAID) BY CAREFULLY ROTATING THE DIELECTRIC. PUSH K-GRIP JR. OVER DIELECTRIC AND UNDER BOTH BRAIDS UNTIL CONTACT SNAPS IN PLACE OR DIELECTRIC BOTTOMS IN CONNECTOR.

STEP 8.
SLIDE K-GRIP SLEEVE AGAINST SHOULDER ON BODY AND FORM HEX BY CRIMPING.

TRIM CODE CHART

| DASH NO. | A | B | C | D |
|----------|------|------|------|------|
| -1 | .250 | .344 | .432 | .156 |
| -2 | .375 | .313 | .500 | .188 |
| -3 | .313 | .281 | .432 | .156 |
| -4 | .281 | .406 | .500 | .187 |

1. REMOVE CABLE OUTER CONDUCTOR AND DIELECTRIC TO .070 DIMENSION AS SHOWN.
2. CHAMFER CENTER CONDUCTOR TO 30° ANGLE AS SHOWN.



NOTE: STEP 1 & 2 MAY BE ACCOMPLISHED WITH EASE AND ACCURACY USING KINGS KTO-3 STRIPPING TOOL.

3. INSERT CABLE INTO BACK END OF CONNECTOR. PUSH CABLE IN FIRMLY UNTIL THE FACE OF CABLE BOTTOMS AGAINST REAR END OF INSULATOR. (CAUTION: EJECTION OF INSULATOR MAY BE PREVENTED BY MATING WITH A CONNECTOR OF OPPOSITE SEX).

INSERT CABLE IN POSITION SHOWN

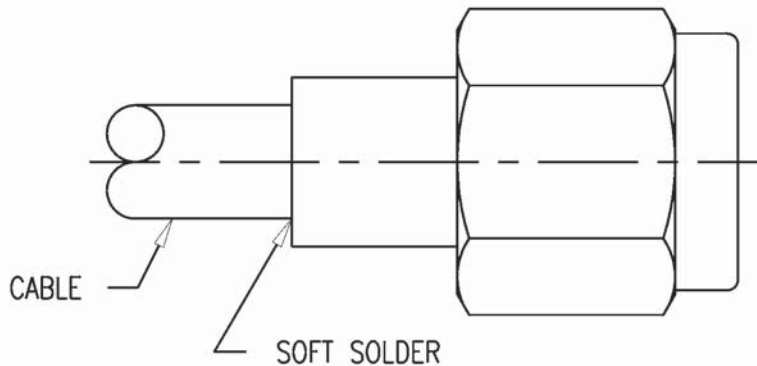

4. SOLDER BACK END OF CONNECTOR.

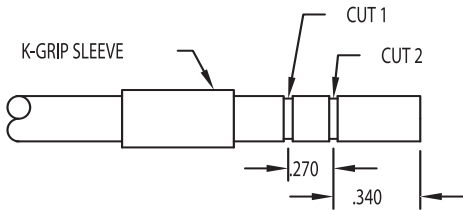

1. CUT CABLE END SQUARE, SLIDE K-GRIP SLEEVE OVER JACKET & WITH TRIM JIG MAKE CUTS 1 AND 2 IN JACKET.



2. REMOVE JACKET TO DIMENSION .340, FLARE OR BULGE BACK BRAID & TRIM WITH SCISSORS AT EDGE OF JACKET.



3. REMOVE JACKET TO DIMENSION .270.

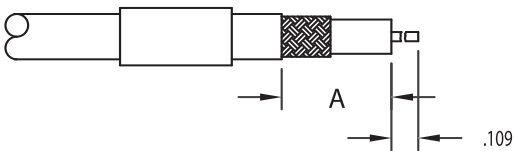

4. TRIM TO DIMENSION A. EXPOSED CENTER CONDUCTOR LENGTH WILL BE EQUAL TO .109 DIMENSION.

5. SOLDER CONTACT FOR THE STRAIGHT CONNECTOR ONLY, THEN PROCEED TO STEP 7.

6. CONTACT NOT USED FOR THE ANGLE CONNECTOR. PROCEED TO STEP 7, THEN SOLDER CABLE CENTER CONDUCTOR TO CONNECTOR CENTER CONTACT.

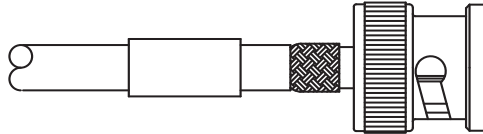

7. CAREFULLY INSERT CABLE INTO CONNECTOR. PUSH K-GRIP JR. OVER DIELECTRIC & UNDER BRAID.

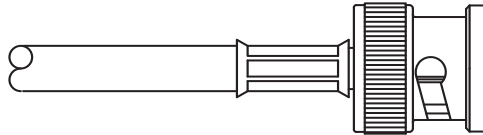

8. SLIDE K-GRIP SLEEVE AGAINST SHOULDER ON BODY AND FORM BY CRIMPING.

| KINGS NO. | A |
|-----------|------|
| 3-483-1 | .390 |
| 3-483-2 | .500 |



1. CUT CABLE END SQUARE, SLIDE K-GRIP SLEEVE AND GASKET OVER JACKET & WITH JACKET TRIM JIG MAKE CUTS 1 AND 2 IN JACKET.



2. REMOVE JACKET TO DIMENSION "A", FLARE OR BULGE BACK BRAID AND FOIL & TRIM WITH SCISSORS AT EDGE OF JACKET.



3. REMOVE JACKET TO DIMENSION "B".

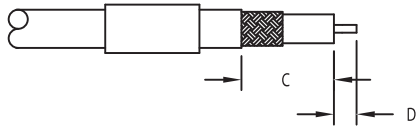

4. USING DIELECTRIC TRIM JIG, TRIM DIMENSION "C". EXPOSED CENTER CONDUCTOR LENGTH WILL BE EQUAL TO DIMENSION "D" OF TRIM CODE.

| TRIM CODE CHART | | | |
|-----------------|------|------|------|
| A | B | C | D |
| .250 | .344 | .432 | .156 |

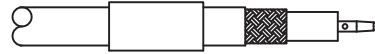

5. SOLDER OR CRIMP CONTACT TO CENTER CONDUCTOR.



6. PUSH K-GRIP JR. OVER DIELECTRIC AND FOIL AND UNDER BRAID UNTIL DIELECTRIC BOTTOMS IN CONNECTOR. SLIDE JACKET GASKET FLUSH WITH JACKET EDGE.



7. SLIDE K-GRIP SLEEVE OVER GASKET AND AGAINST SHOULDER ON BODY AND FORM HEX.



NOTE: CARE MUST BE TAKEN WHEN TRIMMING CABLE THAT THE BRAIDS, INSULATOR AND CONDUCTORS OF THE CABLE ARE NOT NICKED OR DAMAGED.



1. CUT CABLE END SQUARE. PLACE NUT, ITEM 1, COLLET, ITEM 2, THIN WASHER ITEM 3 AND VEE GASKET, ITEM 4 OVER THE JACKET.



4. SLIDE THICK WASHER, ITEM 7 OVER INNER JACKET AND AGAINST OUTER GROUND RING. REMOVE INNER JACKET TO .437 DIMENSION. DO NOT NICK THE BRAID. LENGTH OF INNER BRAID TO BE .435.

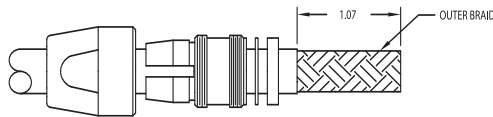

2. REMOVE OUTER JACKET TO 1.07 DIMENSION SHOWN.

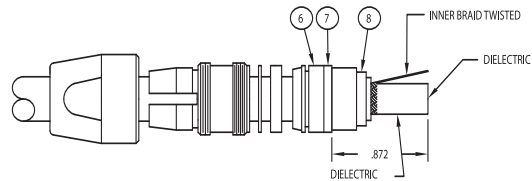

5. PLACE INSULATOR, ITEM 8 OVER THE INNER JACKET AND SEAT AGAINST THE THICK WASHER, ITEM 7 TO .872 DIMENSION. COMB OUT INNER BRAID AND TWIST WIRE STRANDS INTO ONE LEAD AS SHOWN. INNER BRAID MAY BE TRIMMED AS REQUIRED TO FACILITATE TWISTING.



3. PLACE BRAID CLAMP, ITEM 5 OVER THE OUTER BRAID AND SEAT AGAINST THE OUTER JACKET. FOLD THE OUTER BRAID BACK OVER THE BRAID CLAMP, AND PRESS THE OUTER GROUND RING, ITEM 6 OVER THE BRAID CLAMP SO THAT THE OUTER GROUND RING IS FLUSH TO THE EDGE OF THE BRAID CLAMP. (1.055 DIMENSION) TRIM EXCESS BRAID THAT EXTENDS BEYOND THE OUTER DIAMETER OF THE BRAID CLAMP.



6. REMOVE DIELECTRIC TO .085 DIMENSION. EXPOSED CENTER CONDUCTOR TO BE .435 DIMENSION.



7. SLIDE CABLE ASSEMBLY INTO BODY, ITEM 9, AND ALIGN AS SHOWN, PLACING THE CENTER CONDUCTOR INTO THE SLOTTED CENTER CONTACT, AND THE TWISTED INNER BRAID TO BE PLACED ON THE INTERMEDIATE CONTACT TAB. TIGHTEN COLLET, ITEM 2, TO BODY WITH A MINIMUM OF 80 IN-LBS OF TORQUE. IT IS RECOMMENDED NOT TO EXCEED 125 INCH LBS. OF TORQUE. LOCK CLAMP NUT, ITEM 1, TO COLLECT TO PREVENT ROTATION OF CABLE JACKET WITHIN THE CONNECTOR. SOLDER THE TWISTED INNER BRAID TO THE INTERMEDIATE CONTACT TAB, THEN SOLDER THE CENTER CONDUCTOR TO THE CENTER CONTACT. THREAD SCREW CAP, ITEM 10, INTO BODY AND TIGHTEN SECURELY.



1. CUT CABLE END SQUARE. SLIDE CLAMP NUT OVER JACKET & TRIM CABLE TO DIM'S SHOWN.
2. INSERT CLAMP ASSEMBLY BETWEEN DIELECTRIC & BRAID UNTIL DIELECTRIC BOTTOMS IN ASSEMBLY AND CENTER CONDUCTOR IS VISIBLE THROUGH CONTACT SOLDER HOLE. SOLDER CENTER CONDUCTOR.
3. INSERT CABLE ASSEMBLY INTO CONNECTOR BODY, SLIDE CLAMP ASSEMBLY FORWARD UNTIL SEATED AND TIGHTEN CLAMP NUT TO A TORQUE OF 30 INCH/LBS. WHEN TIGHTENING THE CLAMP NUT ASSEMBLY MAKE SURE ONLY THE NUT TURNS, DO NOT ROTATE BODY, DAMAGE TO THE CENTER CONDUCTOR MIGHT OCCUR.



| KINGS PART NO. | CABLE PART NO. M17/ | A DIM ±.016 |
|----------------|---------------------|-------------|
| 872-40-101 | 152-00001 | .220 |
| 876-63-3 | 95-RG-180 | |
| 871-57-3 | 152-00001 | |
| | | |



1. CUT CABLE END SQUARE. SLIDE CLAMP NUT OVER JACKET & TRIM CABLE TO DIM'S SHOWN.
2. INSERT CLAMP ASSEMBLY BETWEEN DIELECTRIC & BRAID UNTIL DIELECTRIC BOTTOMS IN ASSEMBLY AND CENTER CONDUCTOR IS VISIBLE. PRESS CONTACT INTO INSULATOR UNTIL BOTTOMED AND CENTER CONDUCTOR IS VISIBLE THROUGH CONTACT SOLDER HOLE. SOLDER CENTER CONDUCTOR.
3. INSERT CABLE ASSEMBLY INTO CONNECTOR BODY, SLIDE CLAMP ASSEMBLY FORWARD UNTIL SEATED AND TIGHTEN CLAMP NUT TO A TORQUE OF 30 INCH/LBS. WHEN TIGHTENING THE CLAMP NUT ASSEMBLY MAKE SURE ONLY THE NUT TURNS, DO NOT ROTATE BODY, DAMAGE TO THE CENTER CONDUCTOR MIGHT OCCUR.
4. WHEN USING M17/84-RG223 CABLE, A SMALL AMOUNT OF O-RING LUBE MAY BE USED TO FACILITATE CABLE JACKET ENTRY THROUGH THE INTERNAL O-RING. IF DESIRED, THE INTERNAL O-RING MAY BE DISCARDED WHEN USING THIS CABLE.

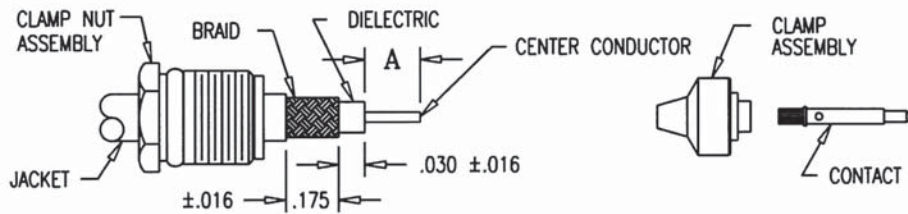

| MILITARY PART NO. M39012/ | KINGS PART NO. | CABLE PART NO. M17/ | A DIM $\pm.016$ | |
|------------------------------|-------------------|------------------------|--------------------|------|
| 55-3009 | 875-82-17 | 28-RG058 | .160 | |
| 55-3109 | 875-82-3 | 60-RG142 | | |
| 56-3109 | 876-61-3 | 84-RG223 | | |
| 56-3009 | 876-61-17 | 155-00001 | | |
| 57-3009 | 873-48-3 | 158-00001 | | |
| 58-3009 | 871-51-3 | 167-00001 | | |
| 59-3009 | 872-45-3 | | | |
| 55-3010 | 875-85-17 | 111-RG303 | | .160 |
| 55-3110 | 875-85-3 | 170-00001 | | |
| 56-3010 | 876-67-17 | | | |
| 56-3110 | 876-67-3 | | | |
| 57-3010 | 873-49-3 | | | |
| 58-3010 | 871-55-3 | | | |
| 59-3010 | 872-46-3 | | | |
| 55-3030 | 875-86-17 | 152-00001 | .220 | |
| 55-3130 | 875-86-3 | | | |
| 56-3030 | 876-62-17 | | | |
| 56-3130 | 876-62-3 | | | |
| 57-3030 | 873-50-3 | | | |
| 58-3030 | 871-56-3 | | | |
| 59-3030 | 872-40-3 | | | |



1. CUT CABLE END SQUARE. SLIDE CLAMP NUT OVER JACKET & TRIM CABLE TO DIM'S SHOWN.
2. INSERT CLAMP ASSEMBLY BETWEEN DIELECTRIC & BRAID UNTIL DIELECTRIC BOTTOMS IN ASSEMBLY AND CENTER CONDUCTOR IS VISIBLE THROUGH CONTACT SOLDER HOLE SOLDER CENTER CONDUCTOR.
3. INSERT CABLE ASSEMBLY INTO CONNECTOR BODY, SLIDE CLAMP ASSEMBLY FORWARD UNTIL SEATED AND TIGHTEN CLAMP NUT TO A TORQUE OF 30 INCH/LBS. WHEN TIGHTENING THE CLAMP NUT ASSEMBLY MAKE SURE ONLY THE NUT TURNS, DO NOT ROTATE BODY, DAMAGE TO THE CENTER CONDUCTOR MIGHT OCCUR.



| MILITARY PART NO. M39012/ | KINGS PART NO. | CABLE PART NO. M17, | A DIM ±.016 | B DIM ±.016 | C DIM ±.016 | D DIM | E DIM | F DIM |
|---|--|--|----------------|----------------|----------------|-------|-------|-------|
| 26-0101 27-0101 28-0101 29-0101 30-0101 | 125-67-5 123-12-5 122-27-5 121-23-5 126-55-5 | J28-RG058 J84-RG223 128-RG400 060-RG142 | .600 | .380 | .220 | .220 | .120 | .050 |
| 26-0102 27-0102 28-0102 29-0102 30-0102 | 125-72-5 123-13-5 122-28-5 121-26-5 126-54-5 | 29-RG59 * 030-RG062 90-RG71 97-RG210 | .660 | .440 | .220 | .259 | .150 | .050 |
| 26-0103 27-0103 28-0103 29-0103 30-0103 | 125-73-5 123-14-5 122-29-5 121-27-5 126-56-5 | 054-RG122 | .600 | .380 | .220 | .180 | .100 | .050 |

* FOR AIR SPACED CABLE USE INSULATOR BUSHING SUPPLIED
 REDUCE "B" DIM (DIELECTRIC ONLY) BY .032 AND INCREASE "C" DIM TO .250



1. CUT CABLE END SQUARE. SLIDE CLAMP NUT OVER JACKET & TRIM CABLE TO DIM'S SHOWN.
2. INSERT CLAMP ASSEMBLY BETWEEN DIELECTRIC & BRAID UNTIL DIELECTRIC BOTTOMS IN ASSEMBLY AND CENTER CONDUCTOR IS VISIBLE THROUGH CONTACT SOLDER HOLE. SOLDER CENTER CONDUCTOR.
WHEN CENTER CONTACT IS SUPPLIED LOOSE INSERT CLAMP ASSEMBLY BETWEEN DIELECTRIC AND BRAID UNTIL DIELECTRIC BOTTOMS IN ASSEMBLY AND CENTER CONDUCTOR IS VISIBLE. PRESS CENTER CONTACT INTO INSULATOR UNTIL BOTTOMED AND CENTER CONDUCTOR IS VISIBLE THROUGH SOLDER HOLE. SOLDER CENTER CONDUCTOR.
3. INSERT CABLE ASSEMBLY INTO CONNECTOR BODY, SLIDE CLAMP ASSEMBLY FORWARD UNTIL SEATED AND TIGHTEN CLAMP NUT TO A TORQUE OF 30 INCH/LBS. WHEN TIGHTENING THE CLAMP NUT ASSEMBLY MAKE SURE ONLY THE NUT TURNS, DO NOT ROTATE BODY, DAMAGE TO THE CENTER CONDUCTOR MIGHT OCCUR.



| MILITARY PART NO. M39012/ | KINGS PART NO. | CABLE PART NO. M17/ | A DIM ±.016 | B DIM ±.016 | C DIM ±.016 | D DIM | E DIM | F DIM |
|---|--|------------------------|----------------|----------------|----------------|-------|-------|-------|
| 26-0104 27-0104 28-0104 29-0104 30-0104 | 125-74-5 123-15-5 122-30-5 121-28-5 126-61-5 | 111-RG303 | .600 | .380 | .220 | .180 | .120 | .050 |
| 26-0117 27-0117 28-0117 29-0117 30-0117 | 125-75-5 123-16-5 122-31-5 121-29-5 126-62-5 | 110-RG302 | .660 | .440 | .220 | .220 | .150 | .050 |
| 26-0018 27-0018 28-0018 29-0018 30-0118 | 125-76-5 123-17-5 122-32-5 121-30-5 126-56-5 | 113-RG316 119-RG174 | .545 | .220 | .325 | .127 | .065 | .025 |

* CENTER CONTACT SUPPLIED LOOSE WITH RG316/RG174 CONNECTORS



1. CUT CABLE END SQUARE. SLIDE CLAMP NUT OVER JACKET & TRIM CABLE TO DIM'S SHOWN.
2. INSERT CLAMP ASSEMBLY BETWEEN DIELECTRIC & BRAID UNTIL DIELECTRIC BOTTOMS IN ASSEMBLY AND CENTER CONDUCTOR IS VISIBLE THROUGH CONTACT SOLDER HOLE SOLDER CENTER CONDUCTOR.
3. INSERT CABLE ASSEMBLY INTO CONNECTOR BODY, SLIDE CLAMP ASSEMBLY FORWARD UNTIL SEATED AND TIGHTEN CLAMP NUT TO A TORQUE OF 65 INCH/LBS. WHEN TIGHTENING THE CLAMP NUT ASSEMBLY MAKE SURE ONLY THE NUT TURNS, DO NOT ROTATE BODY, DAMAGE TO THE CENTER CONDUCTOR MIGHT OCCUR.



| MILITARY PART NO. M39012/ | KINGS PART NO. | CABLE PART NO. M17/ | A DIM ±.016 | B DIM ±.016 | C DIM ±.016 | D DIM | E DIM | F' DIM |
|------------------------------|-------------------|----------------------------------|----------------|----------------|----------------|-------|-------|--------|
| 1-0005 | 1205-35-5 | 6-RG11 | | | | | | |
| 2-0003 | 1203-10-5 | 62-RG144 | | | | | | |
| 2-0006 | 1201-9-5 | 65-RG165 | | | | | | |
| 3-0012 | 1202-9-5 | 74-RG213 | .750 | .468 | .281 | .44 | .295 | .098 |
| 5-0101 | 1206-23-5 | 75-RG214 77-RG216 86-00001 | | | | | | |
| 1-0015 | 1205-37-5 | RG-217 | .718 | .500 | .218 | .57 | .38 | .113 |

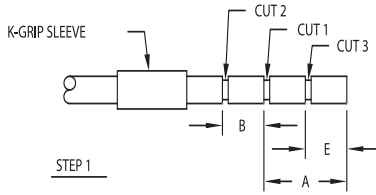

STEP 1



STEP 1A

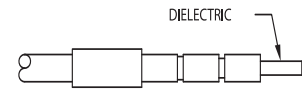

STEP 2



STEP 3
(OPTION b ONLY)



STEP 4
(OPTION a)

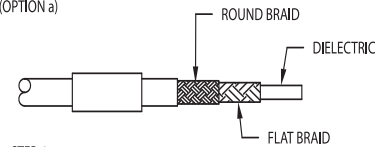

STEP 4
(OPTION b)

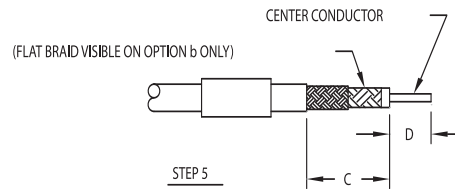

STEP 5



STEP 6

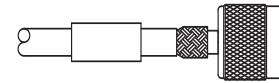

STEP 7

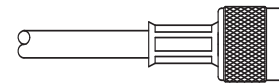

STEP 8

- STEP 1 (OPTION a & b):**
CUT CABLE END SQUARE, SLIDE K-GRIP SLEEVE (SHRINK TUBING OPTIONAL) OVER JACKET. (CAUTION: WHEN USING A SINGLE STEP W/P SLEEVE, SLIDE SMALL END OVER CABLE FIRST AS SHOWN, SEE STEP 1A) MAKE CUTS 1 AND 2 IN JACKET. (OPTION b ONLY): MAKE ADDITIONAL CUT 3 IN JACKET.
- STEP 2 (OPTION a & b):**
REMOVE JACKET TO DIMENSION "A" (OPTION a) OR "E" (OPTION b). REMOVE ROUND BRAID AND FLAT BRAID AT EDGE OF JACKET. BE SURE ENDS OF FLAT BRAID ARE FLAT AGAINST DIELECTRIC. (IF USING OPTION a PROCEED TO STEP 4).
- STEP 3 (OPTION b ONLY):**
REMOVE JACKET TO DIMENSION "A". FLAIR OR BULGE BACK ROUND BRAID ONLY AND TRIM AT EDGE OF JACKET.
- STEP 4 (OPTION a & b):**
REMOVE JACKET TO DIMENSION "B". FLAT BRAID IS VISIBLE ON OPTION b ONLY.
- STEP 5 (OPTION a & b):**
TRIM DIELECTRIC TO DIMENSION "C". EXPOSED CENTER CONDUCTOR LENGTH WILL BE EQUAL TO DIMENSION "D".
- STEP 6 (OPTION a & b):**
PLACE CONTACT ON CENTER CONDUCTOR AND BOTTOM AGAINST DIELECTRIC. SOLDER OR CRIMP CONTACT IN PLACE.
- STEP 7 (OPTION a & b):**
PUSH THE K-GRIP BODY OVER THE DIELECTRIC AND FLAT BRAID AND UNDER ROUND BRAID UNTIL CONTACT SNAPS IN PLACE. (ONCE THE FLAT BRAID IS UNDER THE K-GRIP BODY, A CAREFUL ROTATION OF THE DIELECTRIC AND FLAT BRAID WILL EASE ASSEMBLY UNDER THE ROUND BRAID).
- STEP 8 (OPTION a & b):**
SLIDE K-GRIP SLEEVE AGAINST SHOULDER ON BODY AND FORM HEX BY CRIMPING. (HEAT SHRINK TUBING AS REQUIRED)

TRIM CODE CHART

| DASH NO. | OPTION | A | B | C | D | E |
|----------|--------|------|------|------|------|-------|
| -1 | a | .275 | .312 | .432 | .156 | _____ |
| | b | | | | | .210 |
| -2 | a | .375 | | .500 | .188 | _____ |
| | b | | | | | .260 |
| -3 | a | .293 | | .512 | .094 | _____ |
| | b | | | | | .166 |
| -4 | a | .625 | | .750 | .188 | _____ |
| | b | | | | | .260 |
| -5 | a | .218 | | .250 | .398 | .093 |
| | b | | .140 | | | |
| -6 | a | .250 | .343 | .437 | .156 | _____ |
| | b | | | | | .210 |
| -7 | a | .552 | .270 | .634 | .188 | _____ |
| | b | | | | | .260 |
| -8 | a | .275 | .281 | .400 | .156 | _____ |
| | b | | | | | .210 |
| -9 | a | .563 | .312 | .687 | .188 | _____ |
| | b | | | | | .260 |



1. CUT CABLE END SQUARE. SLIDE CLAMP NUT OVER JACKET & TRIM CABLE TO DIM'S SHOWN.
2. INSERT CLAMP ASSEMBLY BETWEEN DIELECTRIC & BRAID UNTIL DIELECTRIC BOTTOMS IN ASSEMBLY AND CENTER CONDUCTOR IS VISIBLE. PRESS CONTACT INTO INSULATOR UNTIL BOTTOMED AND CENTER CONDUCTOR IS VISIBLE THROUGH CONTACT SOLDER HOLE. SOLDER CENTER CONDUCTOR.
3. INSERT CABLE ASSEMBLY INTO CONNECTOR BODY, SLIDE CLAMP ASSEMBLY FORWARD UNTIL SEATED AND TIGHTEN CLAMP NUT TO A TORQUE OF 30 INCH/LBS. WHEN TIGHTENING THE CLAMP NUT ASSEMBLY MAKE SURE ONLY THE NUT TURNS, DO NOT ROTATE BODY, DAMAGE TO THE CENTER CONDUCTOR MIGHT OCCUR.



| MILITARY PART NO. M39012/ | KINGS PART NO. | CABLE PART NO. M17/ | A DIM $\pm.016$ |
|------------------------------|-------------------|------------------------|--------------------|
| 55-3006 | 875-83-17 | 93-RG178 | .220 |
| 55-3106 | 875-83-3 | 169-00001 | |
| 56-3006 | 876-65-17 | | |
| 56-3106 | 876-65-3 | | |
| 57-3006 | 873-45-3 | | |
| 58-3006 | 871-53-3 | | |
| 59-3006 | 872-42-3 | | |
| 55-3007 | 875-81-17 | 119-RG174 | .220 |
| 55-3107 | 875-81-3 | 173-00001 | |
| 56-3007 | 876-60-17 | 113-RG316 | |
| 56-3107 | 876-60-3 | 172-00001 | |
| 57-3007 | 873-46-3 | | |
| 58-3007 | 871-52-3 | | |
| 59-3007 | 872-43-3 | | |
| 55-3008 | 875-84-17 | 54-RG122 | .220 |
| 55-3108 | 875-84-3 | 157-00001 | |
| 56-3008 | 876-66-17 | | |
| 56-3108 | 876-66-3 | | |
| 57-3008 | 873-47-3 | | |
| 58-3008 | 871-54-3 | | |
| 59-3008 | 872-44-3 | | |

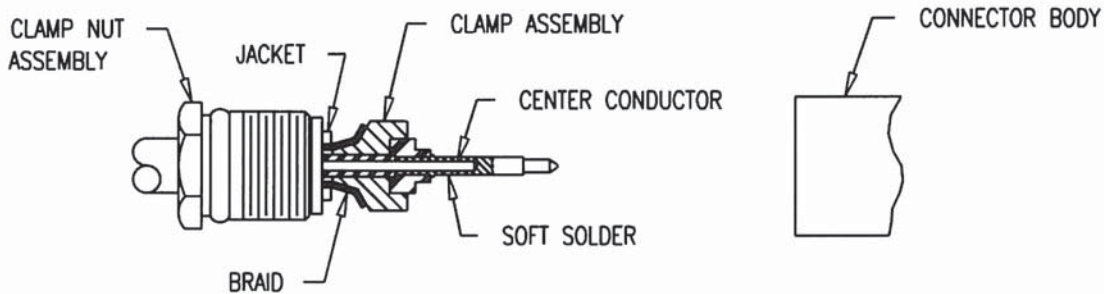

1. CUT CABLE END SQUARE. SLIDE CLAMP NUT OVER JACKET & TRIM CABLE TO DIM'S SHOWN.
2. INSERT CLAMP ASSEMBLY BETWEEN DIELECTRIC & BRAID UNTIL DIELECTRIC BOTTOMS IN ASSEMBLY AND CENTER CONDUCTOR IS VISIBLE THROUGH CONTACT SOLDER HOLE SOLDER CENTER CONDUCTOR.
3. INSERT CABLE ASSEMBLY INTO CONNECTOR BODY, SLIDE CLAMP ASSEMBLY FORWARD UNTIL SEATED AND TIGHTEN CLAMP NUT TO A TORQUE OF 30 INCH/LBS. WHEN TIGHTENING THE CLAMP NUT ASSEMBLY MAKE SURE ONLY THE NUT TURNS, DO NOT ROTATE BODY, DAMAGE TO THE CENTER CONDUCTOR MIGHT OCCUR.

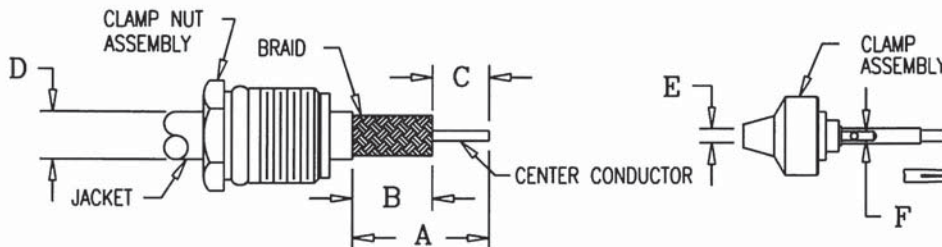

| MILITARY PART NO. M39012/ | KINGS PART NO. | CABLE PART NO. M17/ | A DIM ±.016 | B DIM ±.016 | C DIM ±.016 | D DIM | E DIM | F DIM |
|---|---|--|----------------|----------------|----------------|-------|-------|-------|
| 16-0101 17-0101 18-0102 19-0101 20-0101 | 755-74-5 753-8-5 751-14-5 752-28-5 756-9-5 | 028-RG058 084-RG223 128-RG400 060-RG142 | .563 | .343 | .220 | .220 | .120 | .050 |
| 16-0102 17-0102 18-0101 19-0102 20-0102 | 755-77-5 753-9-5 751-13-5 752-29-5 756-12-5 | 29-RG59 * 030-RG062 90-RG71 97-RG210 | .625 | .406 | .220 | .259 | .150 | .050 |
| 16-0103 17-0103 18-0103 19-0110 | 755-83-5 753-10-5 751-15-5 752-31-5 | 054-RG122 | .563 | .343 | .220 | .180 | .100 | .050 |

* FOR AIR SPACED CABLE USE INSULATOR BUSHING SUPPLIED
REDUCE "B" DIM (DIELECTRIC ONLY) BY .032 AND INCREASE "C" DIM TO .250

| MILITARY PART NO. M39012/ | KINGS PART NO. | CABLE PART NO. M17/ | A DIM ±.016 | B DIM ±.016 | C DIM ±.016 | D DIM | E DIM | F DIM |
|---|--|---------------------------|----------------|----------------|----------------|-------|-------|-------|
| 16-0111 17-0111 18-0111 19-0111 | 755-84-5 753-11-5 751-16-5 752-32-5 | 111-RG303 | .563 | .343 | .220 | .180 | .120 | .050 |
| 16-0118 17-0118 18-0118 19-0118 20-0108 | 755-85-5 753-12-5 751-17-5 752-33-5 756-13-5 | 110-RG-302 | .625 | .406 | .220 | .220 | .150 | .050 |
| 16-0220 17-0220 18-0220 19-0220 | 755-86-5 753-13-5 751-18-5 752-34-5 | 113-RG316 119-RG174 | .545 | .220 | .325 | .127 | .065 | .025 |

1. Cut cable end square. Slide clamp nut over jacket and trim cable to dimensions shown.

2. Insert clamp assembly between dielectric and braid until dielectric bottoms in assembly and center conductor is visible through contact solder hole solder center conductor.

When center contact is supplied loose insert clamp assembly between dielectric and braid until dielectric bottoms in assembly and center conductor is visible. Press center contact into insulator until bottomed and center conductor is visible through solder hole. Solder center conductor.

3. Insert cable assembly into connector body, slide clamp assembly forward until seated and tighten clamp nut to a torque of 30 inch/lbs. When tightening the clamp nut assembly make sure only the nut turns, do not rotate body, damage to the center conductor might occur.



1. CUT CABLE END SQUARE AND SLIDE CLAMP NUT, CABLE CLAMP BODY AND INSULATOR SLEEVE ONTO CABLE.

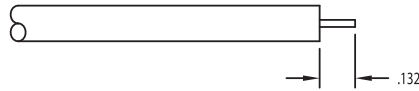

2. REMOVE JACKET TO DIMENSION SHOWN.



3. SOLDER OR CRIMP CONTACT TO CENTER CONDUCTOR.



4. PUSH THE INSULATOR SLEEVE AGAINST THE CENTER CONTACT UNTIL BOTTOMED, THEN PUSH CABLE CLAMP BODY UNTIL BOTTOMED AGAINST INSULATOR SLEEVE, WHILE HOLDING THE CABLE CLAMP BODY AND THE INSULATOR SLEEVE AGAINST THE CONTACT, CRIMP THE CABLE CLAMP BODY IN PLACE AND FORM HEX.



5. FINISHED CRIMP ASSY.



6. PUSH THE CRIMP ASSEMBLY INTO THE BODY UNTIL BOTTOMED, WRENCH TIGHTEN CLAMP NUT INTO CONNECTOR BODY. RECOMMENDED TORQUE 30-35 INCH-POUNDS.

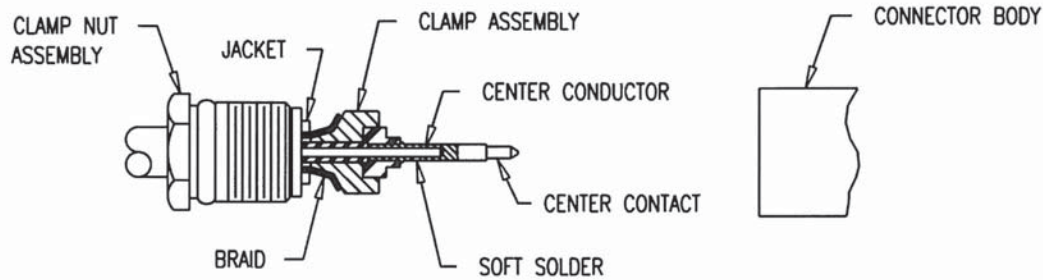

1. CUT CABLE END SQUARE. SLIDE CLAMP NUT OVER JACKET & TRIM CABLE TO DIM'S SHOWN.
2. INSERT CLAMP ASSEMBLY BETWEEN DIELECTRIC AND BRAID UNTIL DIELECTRIC BOTTOMS IN ASSEMBLY AND CENTER CONDUCTOR IS VISIBLE. PRESS CENTER CONTACT INTO INSULATOR UNTIL BOTTOMED AND CENTER CONDUCTOR IS VISIBLE THROUGH SOLDER HOLE. SOLDER CENTER CONDUCTOR.
3. INSERT CABLE ASSEMBLY INTO CONNECTOR BODY, SLIDE CLAMP ASSEMBLY FORWARD UNTIL SEATED AND TIGHTEN CLAMP NUT TO A TORQUE OF 30 INCH-LBS. WHEN TIGHTENING THE CLAMP NUT ASSEMBLY MAKE SURE ONLY THE NUT TURNS, DO NOT ROTATE BODY, DAMAGE TO THE CENTER CONDUCTOR MIGHT OCCUR.

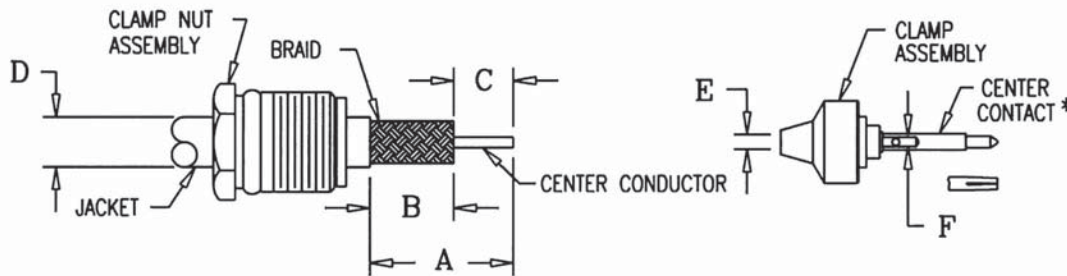

| KINGS PART NO. | CABLE PART NO. M17/ | A DIM ±.016 | B DIM ±.016 | C DIM ±.016 | D DIM | E DIM | F DIM |
|----------------|--|-------------|-------------|-------------|-------|-------|-------|
| 752-38-5 | 152-00001 (RD-316) | .532 | .219 | .313 | | | |
| 1202-16-5 | 113-RG316 119-RG174 | .530 | .210 | .320 | .127 | .065 | .033 |
| 1202-17-5 | RAYTHEON 48152-1 152-00001 (RD-316) | | | | | | |

NOTES:
 * 1. CENTER CONTACT SUPPLIED LOOSE



STEP 1.
CUT CABLE END SQUARE, SLIDE K-GRIP SLEEVE OVER JACKET AND MAKE CUT IN JACKET AT DIMENSION A.

STEP 2.
REMOVE JACKET TO DIMENSION "A".
TRIM OUTER WOVEN BRAID LAYER TO DIMENSION "B".
CAREFULLY FOLD BACK THE REMAINING OUTER WOVEN BRAID LAYER JUST ENOUGH TO CUT AWAY THE THIN FOIL WRAP BETWEEN THE TWO BRAIDS. FOLD THE OUTER BRAID BACK IN POSITION.

STEP 3.
FLARE RIBBON BRAID SLIGHTLY WITH FINGERS TO EDGE OF OUTER BRAID AND FOIL LAYERS. RIBBON SHOULD NOT BE TANGLED OR SHARPLY BENT. TRIM INNER RIBBON BRAID TO "B" DIMENSION SAME AS OUTER BRAID. TRIM DIELECTRIC TO "C" DIMENSION. TRIM CENTER CONDUCTOR TO "D" DIMENSION.

STEP 4.
PLACE CENTER CONTACT ON CENTER CONDUCTOR, BUTT UP AGAINST DIELECTRIC AND CRIMP OR SOLDER IN PLACE.

STEP 5.
ASSEMBLY K-GRIP END OF CONNECTOR BODY ASSEMBLY OVER DIELECTRIC AND UNDER FLARED BRAIDS, PUSHING CONTACT FIRMLY FORWARD UNTIL CONTACT GROOVE SNAPS INTO INTERNAL SHOULDER OF INSULATOR. SLIDE K-GRIP SLEEVE FORWARD OVER BOTH BRAID AGAINST BODY SHOULDER AND CRIMP HEX. USING KINGS CRIMP TOOL KTH-1000 AND DIE SHOWN IN CHART BELOW.

TRIM CODE CHART

| CONNECTOR | A | B | C | D | DIE SIZE |
|-----------|-------|------|------|------|----------|
| 1205-65-5 | 5/8 | 9/32 | .425 | 3/16 | KTH-2005 |
| 1206-31-5 | | | | | |
| 1202-25-5 | | | | | |
| 821-8-5 | | | | | |
| 825-15-5 | | | | | |
| 846-6-5 | 13/16 | 9/32 | .611 | 3/16 | KTH-2005 |
| 845-8-5 | | | | | |



1. CUT CABLE END SQUARE. SLIDE K-GRIP SLEEVE OVER JACKET & MAKE CUTS 1 & 2 THROUGH JACKET ONLY.
2. REMOVE END OF JACKET UP TO CUT 2, FLARE OR BULGE BACK BRAID & TRIM WITH SCISSORS AT EDGE OF JACKET.
3. REMOVE JACKET BETWEEN CUTS 1 & 2 EXPOSING $.406 \pm .010$ LENGTH OF BRAID.
4. TRIM DIELECTRIC TO $.500 \pm .010$ DIM., EXPOSED CENTER CONDUCTOR WILL BE $.187$ REF.
5. PLACE CENTER CONTACT ON CABLE AGAINST DIELECTRIC & CRIMP OR SOLDER IN PLACE.
6. PUSH K-GRIP JR. OVER DIELECTRIC AND UNDER BRAID UNTIL DIELECTRIC BOTTOMS IN CONNECTOR.
7. SLIDE K-GRIP SLEEVE OVER K-GRIP & BRAID TO SHOULDER OF BODY ASSY & FORM HEX USING APPLICABLE CRIMP TOOL & DIE.

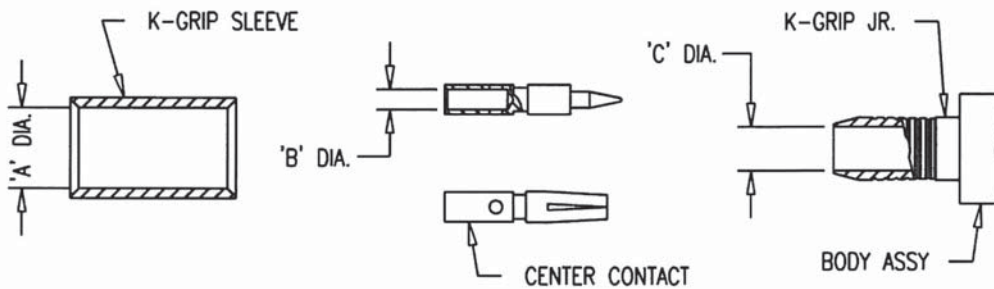

| MILITARY PART NO. | KINGS PART NO. | PIECE PART DIM'S | | | SLEEVE (CRIMP TOOL M22520/5-01 DIE SIZE M22520/5-25) | EQUIV. KINGS DIE SIZE * |
|-------------------|----------------|------------------|------|------|---|-------------------------|
| | | A | B | C | | |
| M39012/01-0017 | 1205-68-5 | .420 | .092 | .297 | CLOSURE A | KTH-2004 |
| M39012/01-0018 | 1205-69-5 | .440 | | | | |

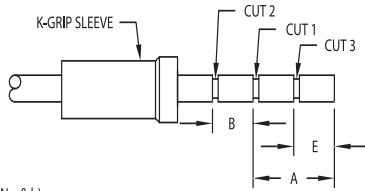

STEP 1 (OPTION a & b):
CUT CABLE END SQUARE, SLIDE K-GRIP SLEEVE OVER JACKET.
(CAUTION: WHEN USING A SINGLE STEP W/P SLEEVE, SLIDE SMALL
END OVER CABLE FIRST AS SHOWN. MAKE CUTS 1 AND 2 IN JACKET.
(OPTION b ONLY): MAKE ADDITIONAL CUT 3 IN JACKET.

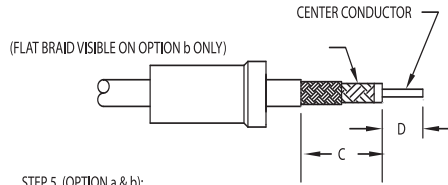

STEP 5 (OPTION a & b):
TRIM DIELECTRIC TO DIMENSION "C". EXPOSED CENTER CONDUCTOR LENGTH
WILL BE EQUAL TO DIMENSION "D".

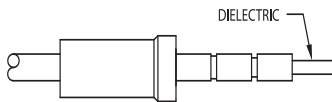

STEP 2 (OPTION a & b):
REMOVE JACKET TO DIMENSION "A" (OPTION a) OR "E" (OPTION b).
REMOVE ROUND BRAID AND FLAT BRAID AT EDGE OF JACKET. BE SURE
ENDS OF FLAT BRAID ARE FLAT AGAINST DIELECTRIC. (IF USING OPTION a
PROCEED TO STEP 4).

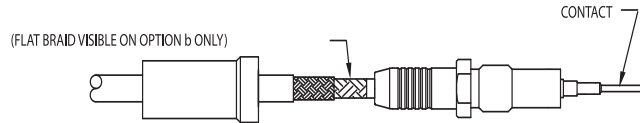

STEP 6 (OPTION a & b):
PUSH THE K-GRIP BODY OVER THE DIELECTRIC AND FLAT BRAID AND UNDER THE ROUND
BRAID (ONCE THE FLAT BRAID IS UNDER THE K-GRIP BODY, A CAREFUL ROTATION OF THE
DIELECTRIC AND FLAT BRAID WILL EASE ASSEMBLY UNDER THE ROUND BRAID). THE CABLE
CENTER CONDUCTOR WILL BE VISIBLE THROUGH THE CONTACT INSPECTION HOLES. CRIMP
OR SOLDER THE CONTACT.

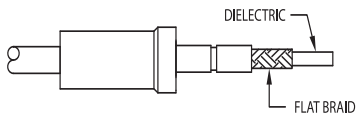

STEP 3 (OPTION b ONLY):
REMOVE JACKET TO DIMENSION "A". FLAIR OR BULGE BACK ROUND BRAID
ONLY AND TRIM AT EDGE OF JACKET.

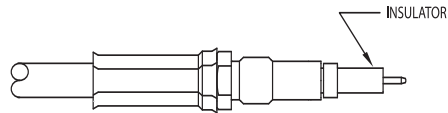

STEP 7
SLIDE K-GRIP SLEEVE AGAINST SHOULDER ON BODY AND FORM HEX BY CRIMPING.
INSTALL THE INSULATOR.

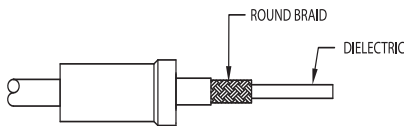

STEP 4 (OPTION a):
REMOVE JACKET TO DIMENSION "B". FLAT BRAID IS VISIBLE ON OPTION
b ONLY.

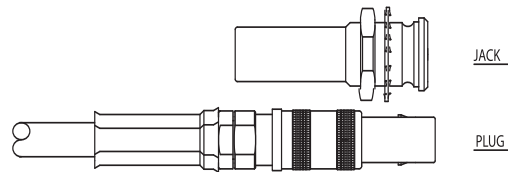

STEP 8
SCREW THE OUTER BODY ONTO THE CRIMPED ASSEMBLY USING A MINIMUM TORQUE OF
5 INCH POUNDS AND A MAXIMUM TORQUE OF 10 INCH POUNDS.

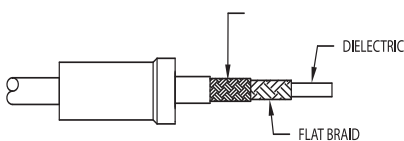

STEP 4 (OPTION b):
REMOVE JACKET TO DIMENSION "B". FLAT BRAID IS VISIBLE ON OPTION
b ONLY.

TRIM CODE CHART

| DASH NO. | OPTION | A | B | C | D | E |
|----------|--------|------|------|------|------|------|
| -1 | a | .625 | .312 | .750 | .188 | — |
| | b | | | | | .260 |



1. CUT CABLE END SQUARE. SLIDE CLAMP NUT, GLAND, GASKET, AND CRIMP SLEEVE OVER THE OUTER JACKET. REMOVE THE OUTER JACKET TO DIMENSION "A".

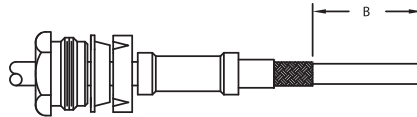

2. REMOVE THE OUTER BRAID TO DIMENSION "B"

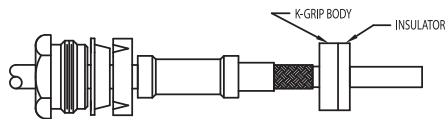

3. INSERT THE CABLE INTO THE K-GRIP BODY WITH THE BRAID OVER THE K-GRIP. SLIDE THE CRIMP SLEEVE OVER THE BRAID AND FORM A HEX WITH THE CRIMP DIE.



4 REMOVE THE INNER JACKET TO DIMENSION "C".

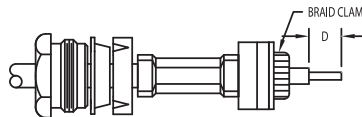

5. PLACE THE BRAID CLAMP OVER THE INNER BRAID AND AGAINST THE INNER JACKET. COMB OUT THE BRAID AND FOLD BACK OVER THE BRAID CLAMP. TRIM EVEN WITH THE BASE OF THE BRAID CLAMP. REMOVE DIELECTRIC TO DIMENSION "D".

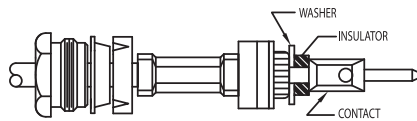

6. INSTALL THE WASHER AND INSULATOR OVER THE DIELECTRIC AND CRIMP THE CENTER CONTACT TO CENTER CONDUCTOR.

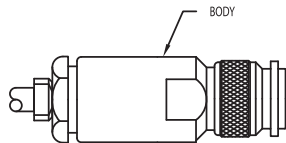

7. ASSEMBLE INNER INSULATOR, INTERMEDIATE CONTACT AND OUTER INSULATOR, THEN INSERT INTO THE BODY. SLIDE THE BACK END PARTS FORWARD. THREAD ASSEMBLY INTO THE CONNECTOR BODY AND TIGHTEN WITH 5 IN. LBS. MIN. AND 30 IN. LBS MAX TORQUE.

| TRIM CODE CHART | | | |
|-----------------|-----|-----|------|
| A | B | C | D |
| 1.03 | .75 | .32 | .156 |



1. CUT CABLE END SQUARE, SLIDE K-GRIP SLEEVE OVER JACKET AND MAKE CUTS 1 AND 2 IN OUTER JACKET ONLY.



4. TRIM DIELECTRIC TO DIMENSION .344 EXPOSED CENTER CONDUCTOR LENGTH WILL BE EQUAL TO 3/16 DIMENSION.



5. SOLDER OR CRIMP CONTACT TO CENTER CONDUCTOR.

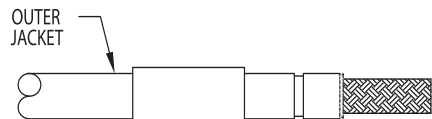

2. REMOVE OUTER JACKET TO .281 DIMENSION, FLARE OR BULGE BACK BRAID AND TRIM WITH SCISSORS AT EDGE OF OUTER JACKET

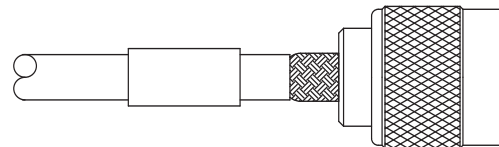

6. PUSH K-GRIP JR. OVER DIELECTRIC AND UNDER BOTH BRAIDS UNTIL DIELECTRIC BOTTOMS IN CONNECTOR.



3. REMOVE JACKET TO .250 DIMENSION.

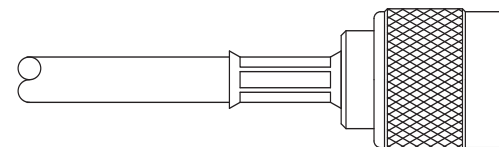

7. SLIDE K-GRIP SLEEVE AGAINST SHOULDER ON BODY AND FORM BY CRIMPING.



NOTES:

- A. CARE MUST BE TAKEN WHEN TRIMMING CABLE THAT THE BRAIDS, INSULATORS AND CONDUCTORS OF THE CABLE ARE NOT NICKED OR DAMAGED.
- B. WHEN A THREE CAVITY DIE IS USED THE FIRST CRIMP ON THE OUTER BRAID (STEP 3) IS DONE WITH THE LARGEST CAVITY. ASSEMBLE DIE IN CRIMP TOOL FRAME USING SHANKS AJACENT TO THAT CAVITY. REVERSE THE DIE IN THE TOOL USING OTHER SHANKS WHEN CRIMPING CENTER CONTACT (STEP 5) AND INNER BRAID (STEP 6).



- 1. CUT CABLE END SQUARE. PLACE CLAMP NUT ASSEMBLY (ITEM 1), SPACER (ITEM 2) AND LARGE CRIMP SLEEVE (ITEM 3) OVER THE JACKET.

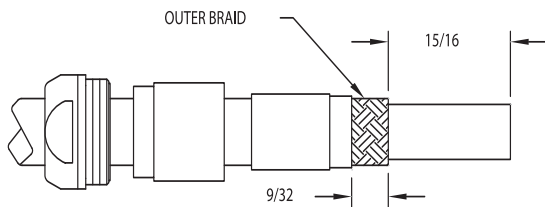

- 2. REMOVE JACKET AND OUTER BRAID TO 15/16 DIM. THEN REMOVE JACKET AN ADDITIONAL 9/32 EXPOSING OUTER BRAID.

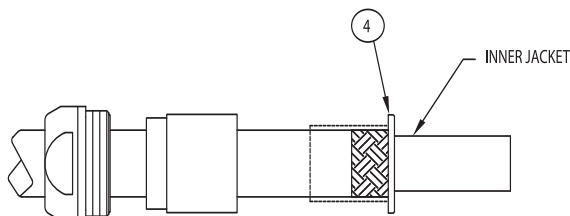

- 3. SLIDE K-GRIP (ITEM 4) OVER INNER JACKET AND UNDER OUTER BRAID. HOLD IN POSITION AND MOVE CRIMP SLEEVE FORWARD AGAINST SHOULDER AND CRIMP IN PLACE USING APPROPRIATE HEX DIE.



- 4 A. REMOVE INNER JACKET AND INNER BRAID TO 19/32 DIM. REMOVE INNER JACKET AN ADDITIONAL 5/16 EXPOSING INNER BRAID.
- B. REMOVE DIELECTRIC TO 11/16 DIM. AND CUT CENTER CONDUCTOR TO BE 1/8 LONG.



- 5. PLACE THE MALE OR FEMALE CONNECTOR CONTACT (ITEM 7) ON THE CABLE CENTER CONDUCTOR, BOTTOM AGAINST DIELECTRIC AND SOLDER OR CRIMP IN PLACE.

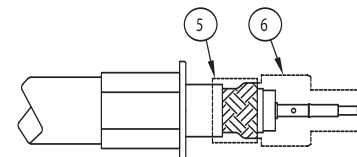

- 6. PLACE SMALL SLEEVE (ITEM 5) OVER INNER BRAID OF CABLE. SLIDE BODY ASSEMBLY (ITEM 6) OVER THE DIELECTRIC AND UNDER THE INNER BRAID UNTIL THE CENTER CONTACT LOCKS IN PLACE IN BODY ASSEMBLY. (NOTE: CAUTION MUST BE EXERCISED NOT TO ALLOW ANY BRAID STRANDS TO REMAIN INSIDE THE BODY ASSEMBLY. ALL BRAID MUST BE ON THE OUTSIDE OF THE BODY). SLIDE CRIMP SLEEVE FORWARD OVER BOTH THE BODY AND BRAID TO THE BODY SHOULDER. CRIMP IN PLACE. PUSH ALL LOOSE PARTS FORWARD ON CABLE AND INSERT INTO MAIN CONNECTOR BODY (ITEM 8). THREAD CLAMP NUT ASSEMBLY INTO BODY AND LOCK SECURELY.

"U" SPACER, ITEM 9 IS SUPPLIED ONLY WITH SMALL CABLE CONNECTORS. IT IS PLACED OVER ITEM 5 AFTER CRIMPING & BEFORE THREADING CABLE ASSEMBLY INTO BODY. RECOMMENDED TORQUE: 80 IN LBS.

CABLING PROCEDURE FOR M17/130-00004

1. CUT CABLE END SQUARE
2. WHEN USING T-FLEX402HF CABLE SOLDER DIP CABLE PER SHEET 2 OF 3-648.
3. TRIM CABLE TO DIMENSIONS SHOWN.
5. SOLDER CABLE IN BODY



4. INSERT TRIMMED CABLE INTO CONNECTOR.
BOTTOM CABLE AGAINST INSULATOR (ASSEMBLE MATING CONNECTOR
TO PREVENT INSULATOR MOVEMENT).

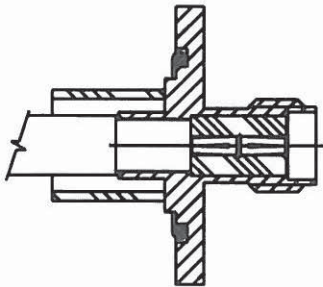

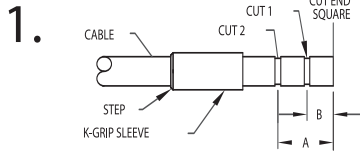

1. CUT THE CABLE-END SQUARE. SLIDE THE K-GRIP SLEEVE ONTO THE CABLE. MAKE "CUT 1" AND "CUT 2" IN THE JACKET.

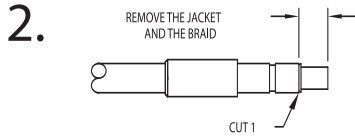

2. REMOVE THE JACKET AND THE BRAID TO DIMENSION B. TO REMOVE THE BRAID: FLARE BACK OR BULGE BACK THE BRAID AND TRIM WITH SCISSORS AT "CUT 1"

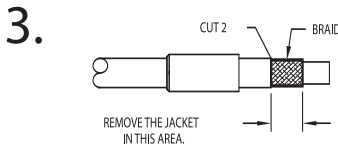

3. REMOVE JACKET TO DIMENSION A

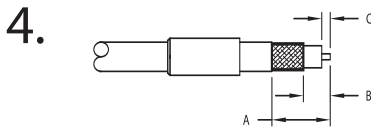

4. TRIM DIELECTRIC FROM CABLE END TO DIMENSION "C". EXPOSED CENTER CONDUCTOR LENGTH WILL BE EQUAL TO DIMENSION "C".

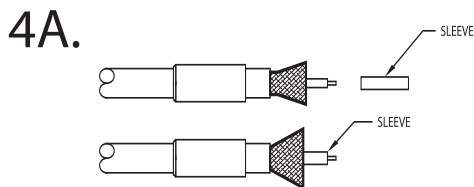

4A. FLARE BRAID TO PERMIT INSERTION OF SLEEVE, SHOULDER END FIRST, OVER DIELECTRIC AND UNDER BRAID.

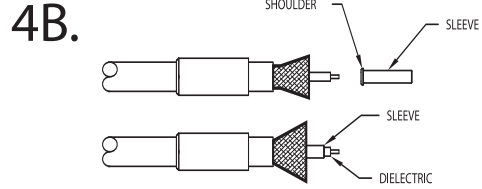

4A. FLARE BRAID TO PERMIT INSERTION OF SLEEVE, SHOULDER END FIRST, OVER DIELECTRIC AND UNDER BRAID. A SHORT LENGTH OF DIELECTRIC SHOULD BE VISIBLE.

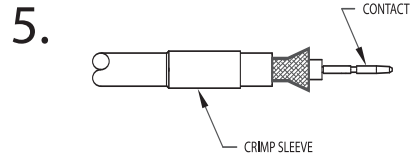

5. WITH THE BRAID FLARED, SLIDE CONTACT INTO POSITION AND CRIMP CONTACT TO CENTER CONDUCTOR.

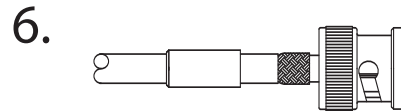

6. PUSH K-GRIP JR. OVER DIELECTRIC & UNDER BRAID UNTIL CENTER CONTACT IS LOCKED IN INSULATOR (THIS CAN BE CHECKED BY APPLYING SLIGHT FINGER PRESSURE TO THE CABLE).

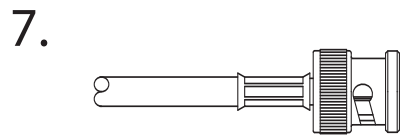

7. SLIDE K-GRIP SLEEVE AGAINST SHOULDER ON BODY AND FORM BY CRIMPING.

NOTES:

1. STEP 4A APPLIES ONLY TO CONNECTORS SUPPLIED W/PLASTIC SLEEVE
2. STEP 4B APPLIES ONLY TO CONNECTORS SUPPLIED W/METAL SLEEVE

| DASH NO | A | B | C |
|---------|------|------|------|
| -1 | .624 | .312 | .155 |
| -2 | .624 | .312 | .249 |
| -3 | .687 | .375 | .187 |
| -4 | .668 | .356 | .200 |
| -5 | .687 | .375 | .219 |
| -6 | .540 | .250 | .150 |

735 CABLE INSTALLATION INSTRUCTIONS USING KINGS DIE SET KTH-2185

1. SLIDE CRIMP SLEEVE ONTO CABLE WITH STEP LOCATED AWAY FROM THE CONNECTOR BODY.

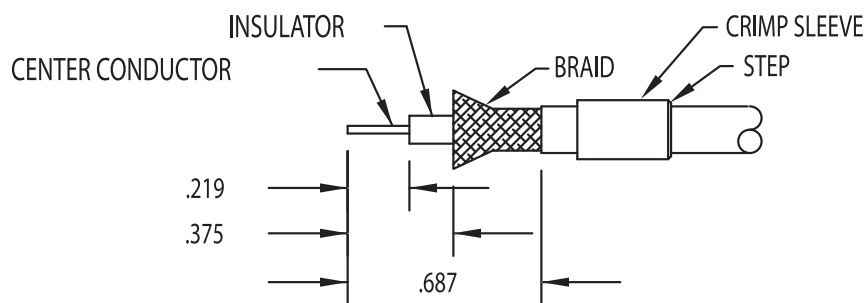

3. SLIDE THE CONTACT ALL THE WAY ONTO THE CENTER CONDUCTOR. BE SURE THAT CONTACT BUTTS AGAINST THE DIELECTRIC. CRIMP CONTACT TO CENTER CONDUCTOR. REQUIRED DIE FLAT DIMENSIONS ARE .042". USE OF APPROVED 12 POINT CRIMP TOOLS IS OPTIONAL.

4. SLIGHTLY FAN OUT THE BRAID AT THE END. PUSH CABLE INTO CONNECTOR UNTIL CONTACT SNAPS INTO PLACE. ALL BRAID WIRES MUST BE OVER THE SUPPORT SLEEVE. FOIL MUST BE UNDER SUPPORT SLEEVE.

5. DRESS THE BRAID EVENLY AROUND THE SUPPORT SLEEVE. SLIDE CRIMP SLEEVE FORWARD OVER BRAID AND AGAINST CONNECTOR. FORM BY CRIMPING. REQUIRED DIE FLAT DIMENSIONS ARE .178".

INSTALLATION INSTRUCTIONS

CARD COLOR RED/BLACK MARKING

FOR 735-TYPE CABLE USING KTH-2185

1. SLIDE CRIMP SLEEVE ONTO CABLE WITH STEP LOCATED AWAY.
2. STRIP CABLE AS SHOWN BELOW. THE LENGTHS IN THIS PICTURE ARE ACTUAL SIZE AND MAY BE USED AS GAUGE.



3. SLIDE THE CONTACT ALL THE WAY ON TO THE CENTER CONDUCTOR. BE SURE THAT CONTACT BUTTS AGAINST THE DIELECTRIC. CRIMP CONTACT TO CENTER CONDUCTOR. REQUIRED DIE FLAT DIMENSIONS ARE .042". USE OF APPROVED 12 POINT CRIMP TOOLS IS OPTIONAL.



4. SLIGHTLY FAN OUT THE BRAID AT THE END. PUSH CABLE INTO CONNECTOR UNTIL CONTACT SNAPS INTO PLACE. ALL BRAID WIRES MUST BE OVER THE SUPPORT SLEEVE. FOIL MUST BE UNDER SUPPORT SLEEVE.

5. DRESS THE BRAID EVENLY AROUND THE SUPPORT SLEEVE. SLIDE CRIMP SLEEVE FORWARD OVER BRAID AND AGAINST CONNECTOR. FORM BY CRIMPING. REQUIRED DIE FLAT DIMENSIONS ARE .178".

FOR TECHNICAL SUPPORT CALL (888) 909-5551.

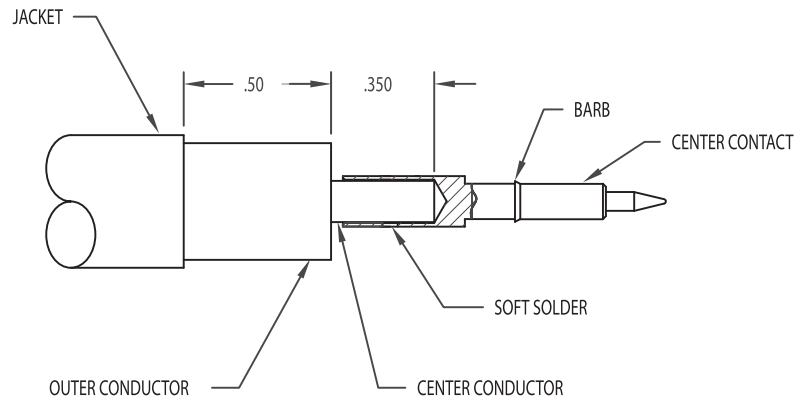

- 1) TRIM CABLE AS SHOWN. CARE MUST BE TAKEN TO AVOID METAL PARTICLES ON DIELECTRIC FACE.
- 2) BOTTOM CABLE CENTER CONDUCTOR IN CONTACT WIRE HOLE. HOLD IN POSITION AND SOFT SOLDER.
- 3) INSERT CONTACT INTO BODY ASSEMBLY AND PUSH CONTACT BARB INTO TEFLON INSULATOR UNTIL CABLE BOTTOMS IN BODY.
- 4) SOFT SOLDER BODY TO CABLE OUTER CONDUCTOR.

1.

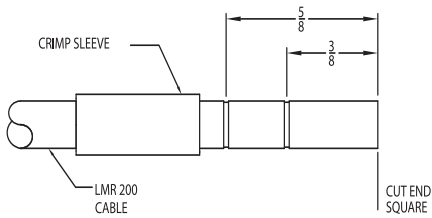

1. CUT THE CABLE-END SQUARE. SLIDE THE CRIMP SLEEVE ONTO THE CABLE. MAKE CUTS IN THE JACKET AT 3/8" AND 5/8" FROM THE END OF THE CABLE.

5.



5. SLIGHTLY FLARE THE BRAID AND SLIDE CONTACT INTO POSITION AND CRIMP CONTACT TO CENTER CONDUCTOR USING KTH-1000 CRIMP TOOL AND KTH-2026 DIE SET.

2.

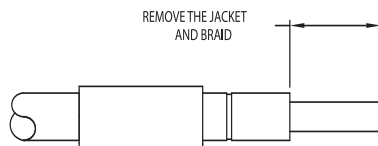

2. REMOVE THE JACKET AND BRAID TO THE FIRST CUT, 3/8" FROM THE CABLE-END. TO REMOVE THE BRAID, FLARE BACK OR BULGE THE BRAID AND TRIM WITH SCISSORS.

6.

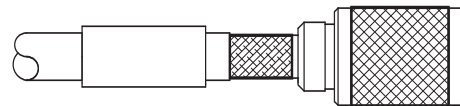

6. PUSH K-GRIP OF CONNECTOR OVER DIELECTRIC AND FOIL AND UNDER THE CABLE BRAID UNTIL THE DIELECTRIC BOTTOMS IN THE CONNECTOR.

3.

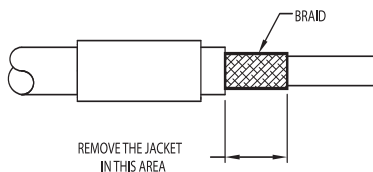

3. REMOVE THE JACKET TO THE SECOND CUT, 5/8" FROM CABLE-END.

7.

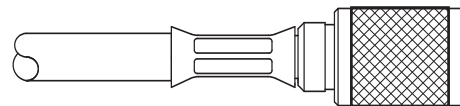

7. SLIDE CRIMP SLEEVE OVER K-GRIP AND BRAID TO THE CONNECTOR BODY SHOULDER. CRIMP IN PLACE USING KTH-1000 CRIMP TOOL AND KTH-2026 DIE SET.

4.

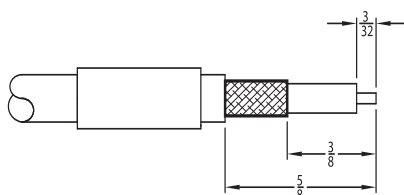

4. TRIM DIELECTRIC 3/32" FROM CABLE END TO EXPOSE CENTER CONDUCTOR.

NOTES:
NO SPECIFIC ORIENTATION FOR CRIMP SLEEVE.

1.

1. CUT THE CABLE-END SQUARE. SLIDE THE CLAMP NUT ONTO THE CABLE. MAKE CUT 1 AND CUT 2 IN THE JACKET.

2.

2. REMOVE JACKET, BRAID AND FILLERS TO .35 DIMENSION. TO REMOVE THE BRAID: FLARE BACK OR BULGE BACK THE BRAID AND TRIM WITH SCISSORS AT "CUT 1".

3.

3. REMOVE CABLE OUTSIDE JACKET TO LEAVE BRAID EXPOSED.

4.

4. INSERT SOLDER TAIL OVER THE BRAID UNTIL BOTTOMED. SOFT SOLDER IN PLACE, USING RMA SOLDER. HEAT AND APPLY SOLDER INTO THE (2) SMALLER SOLDER HOLES. AFTER SOLDERING, TRIM & STRIP WIRES TO DIMENSIONS AS SHOWN.

5.

5. INSERT SHRINK INSULATION TUBING P/N 1-8449 OVER THE WHITE WIRE. SECURE CABLE AND SOLDER TAIL TO CONNECTOR ASSEMBLY. SOLDER WHITE SLEEVE WIRE TO CENTER CONTACT. SOLDER CLEAR SLEEVE WIRE TO INTERMEDIATE CONTACT. MAKE SURE NOT TO HAVE ANY SOLDER BRIDGE BETWEEN CENTER AND INTERMEDIATE CONTACTS. HEAT SHRINK INSULATION TUBING P/N 1-8449 OVER THE CENTER CONTACT/WHITE WIRE SOLDER JOINT AS SHOWN.

6.

6. TORQUE CLAMP NUT TO BODY ASSEMBLY AND LOCK SECURELY. RECOMMENDED TORQUE: 20-26 IN.-LBS. STAKE 1 PLACE ON BODY AS A THREADLOCK FEATURE TO LOCK CLAMP NUT IN PLACE.



1. CUT THE CABLE-END SQUARE. SLIDE THE CRIMP SLEEVE ONTO THE CABLE. MAKE CUTS IN THE JACKET AT .32" FROM THE END OF THE CABLE.



5. SLIDE STIFFENER SLEEVE OVER CABLE DIELECTRIC. CRIMP CONTACT INTO PLACE WITH NAIL HEAD AGAINST DIELECTRIC.



2. REMOVE THE JACKET AND BRAID TO THE FIRST CUT. SLIT THE JACKET 2 PLACES AS SHOWN. .28 LONG.



6. INSERT CONTACT INTO K-GRIP OF CONNECTOR AND SNAP INTO PLACE. FOLD WIRE AND JACKET SECTIONS OVER K-GRIP.



3. FOLD BACK TWO JACKET SECTIONS ALONG WITH OUTER CONDUCTOR WIRE STRANDS.



7. SLIDE CRIMP SLEEVE OVER K-GRIP AND JACKET TO THE CONNECTOR BODY SHOULDER AND CRIMP IN PLACE.



4. REMOVE FOIL AS CLOSE TO FOLDED BACK JACKET AS POSSIBLE. TRIM DIELECTRIC AS SHOWN.

NOTES:

1. LARGE I.D. OF CRIMP SLEEVE TO GO OVER K-GRIP BODY OF CONNECTOR.



1. WITH CLAMP NUT, SLIP WASHER & GASKET ON CABLE, REMOVE JACKET TO $.312 \pm .015$ DIM.
2. SLIDE BRAID CLAMP OVER BRAID AGAINST JACKET EDGE. COMB OUT BRAID WIRES, FOLD BACK OVER BRAID CLAMP & TRIM AS SHOWN.
3. REMOVE DIELECTRIC TO $.045 \pm .005$ DIM. & TRIM CENTER CONDUCTOR TO $.156 \pm .015$ DIM.
4. SOLDER CENTER CONTACT TO CENTER CONDUCTOR.
5. THREAD ASSEMBLY SECURELY INTO CONNECTOR BODY. RECOMMENDED TORQUE: 55-60 IN.LBS.



| MILITARY PART NUMBER | KINGS NUMBER | CABLE USAGE | PIECE PART DIM'S. | | |
|--|-----------------------------------|---------------------------------|-------------------|--------|--------|
| | | | A DIA. | B DIA. | C DIA. |
| M39012/06-0001 M39012/08-0002 M39012/11-0001 | KD-59-132 KD-19-71 KD-19-61 | RG-5,6,21,143, 212,222,304/U | .35 | .27 | .06 |
| M39012/06-0002 M39012/08-0001 M39012/11-0002 | KD-59-119 KD-19-72 KD-19-73 | RG-8,9,213, 214/U | .44 | .37 | .10 |



1. CUT CABLE END SQUARE, PLACE CLAMP NUT, SLIP WASHER (WHEN SUPPLIED) AND VEE-GASKET OVER JACKET. REMOVE JACKET TO DIMENSION "A".

| TRIM CODE CHART | | | |
|-----------------|------|------|------|
| DASH NO. | A | B | C |
| -1 | .625 | .288 | .218 |



2. COMB OUT BRAID AND TAPER FORWARD. PLACE BRAID CLAMP OVER BRAID AGAINST JACKET CUT.

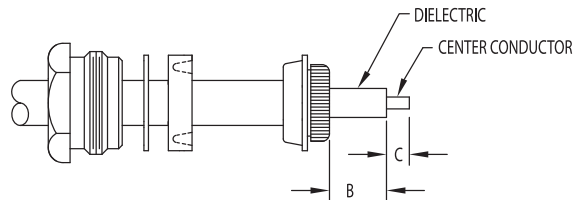

3. FOLD OUTER BRAID BACK OVER BRAID CLAMP AND TRIM AS SHOWN. REMOVE INNER JACKET TO EDGE OF OUTER BRAID. COMB OUT INNER BRAID AND FOLD BACK OVER OUTER BRAID AND BRAID CLAMP. TRIM INNER BRAID AS SHOWN. REMOVE DIELECTRIC TO DIMENSION "B". CUT CENTER CONDUCTOR TO DIMENSION "C".



4. PLACE BUSHING AND REAR INSULATOR OVER DIELECTRIC AND AGAINST BRAID CLAMP AS SHOWN. SOLDER OR CRIMP (WHEN APPLICABLE) CONTACT TO CENTER CONDUCTOR.

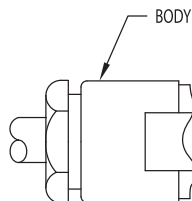

5. PLACE FRONT INSULATOR OVER CONTACT. THREAD ASSEMBLY INTO CONNECTOR BODY AND LOCK SECURELY. VEE-GASKET MUST BE SPLIT BY BRAID CLAMP. (35-40 IN-LBS RECOMMENDED TORQUE).



1. CUT CABLE END SQUARE. SLIDE CLAMP NUT, WASHER & GASKET OVER JACKET.
2. REMOVE JACKET TO $3/8$ DIMENSION WITHOUT NICKING BRAID.
3. SLIDE BRAID CLAMP OVER BRAID AND BUTT AGAINST JACKET SHOULDER.
4. COMB OUT BRAID WIRES, FLARE OVER BRAID CLAMP SHOULDER AND TRIM AS SHOWN.
5. REMOVE DIELECTRIC TO $.125$ DIMENSION. DO NOT NICK CENTER CONDUCTOR.
6. CUT CENTER CONDUCTOR TO $5/32$ DIMENSION AND TIN.
7. ASSEMBLE BUSHING, INSULATOR AND CENTER CONTACT ON CABLE AS SHOWN. SOLDER CONTACT IN POSITION WITHOUT DISTORTING DIELECTRIC BY OVER HEATING.
8. THREAD ASSEMBLY INTO CONNECTOR BODY AND TIGHTEN SUFFICIENTLY TO SPLIT GASKET AND INSURE GOOD CONTACT BETWEEN BRAID CLAMP AND WASHER.



1. TRIM CABLE TO DIMENSIONS SHOWN. DO NOT NICK CENTER CONDUCTOR. CHAMFER CENTER CONDUCTOR AS SHOWN.

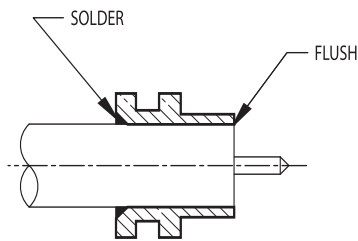

2. INSERT CABLE INTO BODY. BODY AND CABLE TO BE FLUSH AT INTERFACE. SOLDER CABLE INTO BODY. TRIM ANY EXCESS DIELECTRIC MATERIAL.

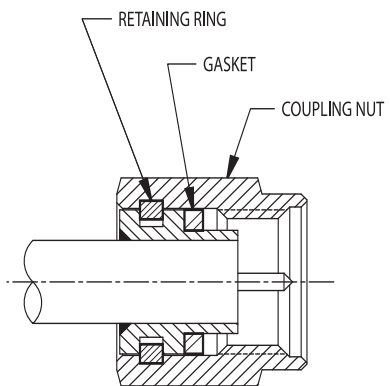

3. ASSEMBLE GASKET, RETAINING RING, AND COUPLING NUT.

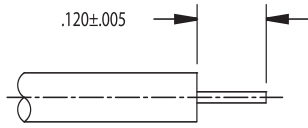

1. TRIM CABLE TO DIMENSIONS SHOWN. DO NOT NICK CENTER CONDUCTOR.

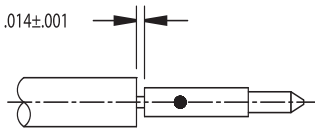

2. SOLDER CONDUCTOR TO CENTER CONTACT. LEAVE GAP AS SHOWN. CLEAN.

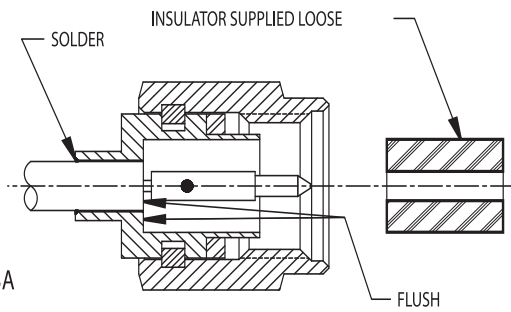

FIG. 3A

3. FOR CONNECTORS WITH INSULATORS SUPPLIED LOOSE: INSERT CABLE INTO BODY UNTIL CABLE IS FLUSH WITH SHOULDER IN BODY. SOLDER CABLE INTO BODY. TRIM ANY EXCESS DIELECTRIC MATERIAL. CLEAN. REFER TO FIG. 3A. FOR CONNECTORS WITH INSULATORS INSTALLED: INSERT CABLE INTO BODY UNTIL IT BUTTS AGAINST INSULATOR. SOLDER CABLE INTO BODY. CLEAN. REFER TO FIG. 3B.

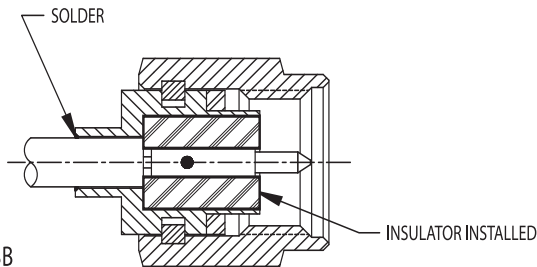
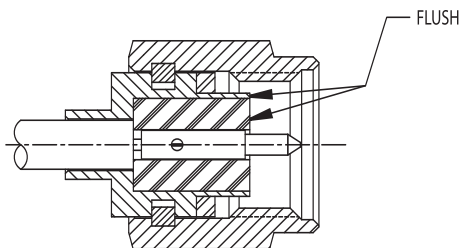

FIG. 3B



4. FOR CONNECTORS WITH INSULATORS SUPPLIED LOOSE: PRESS IN INSULATOR FLUSH TO BODY.



1. TRIM CABLE TO DIMENSIONS SHOWN. DO NOT NICK CENTER CONDUCTOR.



2. INSERT CABLE INTO BODY. DIELECTRIC MUST BUTT AGAINST CENTER CONTACT, AND CENTER CONDUCTOR MUST ENTER SLOT IN CONTACT. SOLDER CABLE INTO BODY. CLEAN.

3. SOLDER CONDUCTOR INTO SLOT THROUGH REAR ACCESS HOLE. CLEAN.



4. ASSEMBLE CAP INTO BODY:
 FOR FLAT CAPS, SOLDER CAP INTO BODY AND CLEAN (SEE FIG. 4A)
 FOR DOME CAPS, PLACE INSULATOR DISC (IF REQUIRED) INTO BODY. PLACE CAP IN BODY WITH DOME UP AND PRESS OR DIMPLE CAP. (SEE FIG. 4B)
 FOR PRESS FIT CAPS, PRESS CAP INTO BODY. (SEE FIG. 4C)



1. TRIM CABLE TO DIMENSION SHOWN. DO NOT NICK CENTER CONDUCTOR.

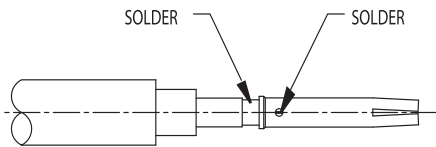

2. SOLDER CONTACT TO CENTER CONDUCTOR. CLEAN.

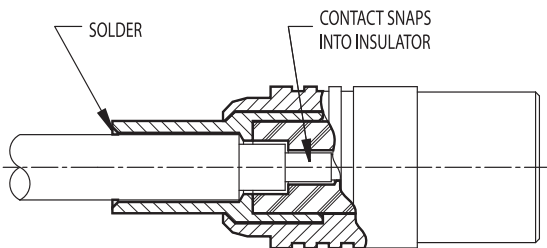

3. INSERT CENTER CONTACT INTO BODY UNTIL IT SNAPS INTO INSULATOR.

4. SOLDER CABLE JACKET TO BODY. CLEAN.



1. TRIM CABLE TO DIMENSION SHOWN. DO NOT NICK CENTER CONDUCTOR.



2. INSERT CABLE INTO BODY UNTIL CABLE BOTTOMS IN BODY. CENTER CONDUCTOR MUST ENTER SLOT IN CONTACT. SOLDER CONTACT. CLEAN.



3. SOLDER CABLE JACKET INTO BODY. CLEAN.

4. PLACE INSULATOR INTO ACCESS HOLE OVER CONTACT.

5. PLACE DOME CAP INTO BODY AND PRESS FLAT OR DIMPLE.

| PART NUMBER | | A |
|--------------|--------------|------|
| 470-500-0470 | 471-500-0470 | .040 |
| 470-500-0850 | 471-500-0850 | .050 |

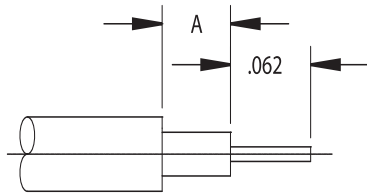

1. Trim cable to dimension shown. Do not nick center conductor.

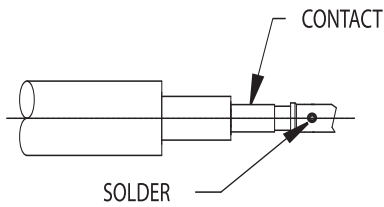

2. Solder contact to center conductor. Clean.

3. Insert center contact into body until it snaps into insulator.

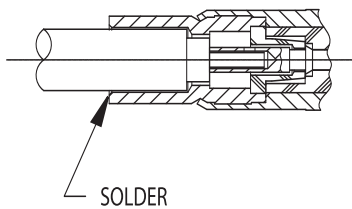

4. Solder cable jacket to body. Assure cable jacket bottoms in connector body while soldering. Allow to cool. Clean.

| PART NUMBER | A |
|--------------|------|
| 472-500-0470 | .040 |
| 472-500-0850 | .050 |

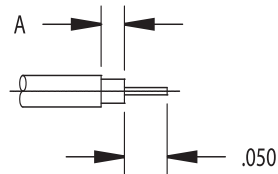

1. Trim cable to dimensions shown. Do not nick center conductor.

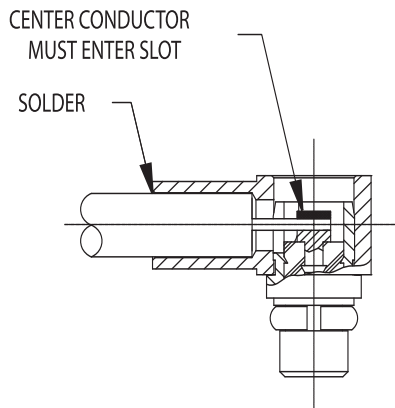

2. Insert cable into body until it butts. Center conductor must enter slot of contact.

3. Solder cable jacket into body. Assure cable jacket bottoms in connector body while soldering. Allow to cool. Clean.

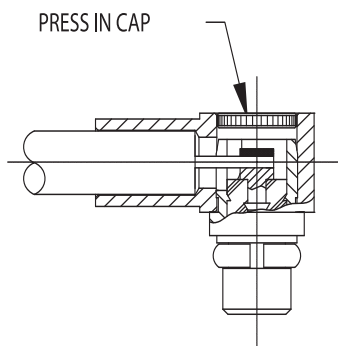

4. Solder center conductor of cable into slot of contact. Allow to cool. Clean. Press cap into body.

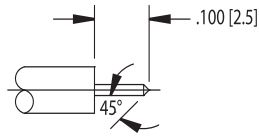

FOR RG-402 (Ø.141) CABLE

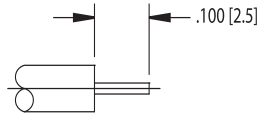

FOR RG-405 (Ø.085) CABLE

FIGURE 1

1. TRIM CABLE TO DIMENSIONS SHOWN. DO NOT NICK CENTER CONDUCTOR. (SEE FIG. 1)

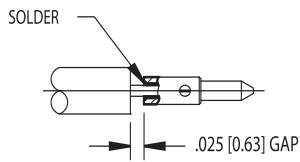

FIGURE 2

SKIP THIS STEP WHEN USING RG-402 (Ø.141) CABLE

2. SLIDE CENTER CONDUCTOR OF CABLE INTO REAR CONTACT. SET GAP BETWEEN CONTACT AND DIELECTRIC OF CABLE. SOLDER. CLEAN. (SEE FIG. 2)

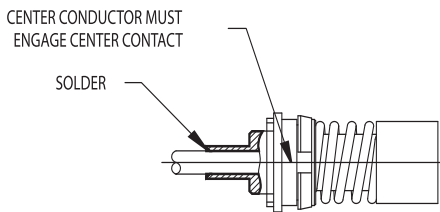

FIGURE 3

2. INSERT CABLE INTO BODY UNTIL IT BUTTS UP AGAINST COUNTERBORE. CENTER CONDUCTOR MUST ENGAGE TINES IN CENTER CONTACT. SOLDER OUTER CONDUCTOR OF CABLE TO BODY. CLEAN. (SEE FIG. 3)

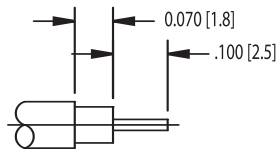

FIGURE 1

1. TRIM CABLE TO DIMENSIONS SHOWN. DO NOT NICK CENTER CONDUCTOR. (SEE FIG. 1)

2. INSERT CABLE INTO BODY UNTIL IT BUTTS UP AGAINST COUNTERBORE. CENTER CONDUCTOR MUST ENTER SLOT IN CENTER CONTACT. SOLDER OUTER CONDUCTOR OF CABLE TO BODY. CLEAN. (SEE FIG. 2)

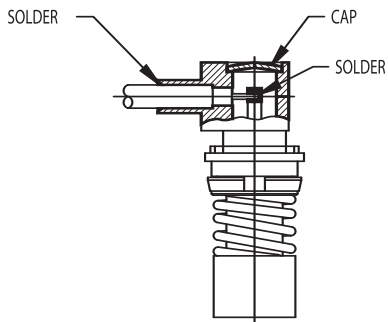

FIGURE 2

3. SOLDER CENTER CONDUCTOR OF CABLE TO CENTER CONTACT. CLEAN. (SEE FIG. 2)

4. PLACE CAP INTO BODY AS SHOWN AND DEPRESS CAP TO EXPAND INSIDE COUNTERBORE OF BODY. (SEE FIG. 2)



1. TRIM CABLE TO DIMENSIONS SHOWN. DO NOT NICK THE CENTER CONDUCTOR.

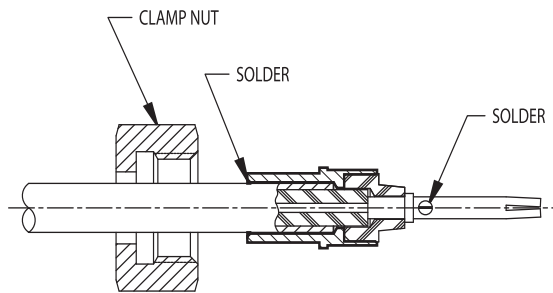

2. SLIDE CLAMP NUT OVER CABLE. INSERT CABLE INTO SLEEVE ASSEMBLY. CENTER CONDUCTOR MUST PASS THROUGH HOLE IN INSULATOR. CABLE JACKET MUST BUTT AGAINST SHOULDER INSIDE SLEEVE. SOLDER CABLE INTO SLEEVE. CLEAN.

3. ASSEMBLE CENTER CONTACT TO CENTER CONDUCTOR BY INSERTING INTO HOLE OF INSULATOR. SOLDER CONDUCTOR THROUGH HOLE IN CONTACT. CLEAN.

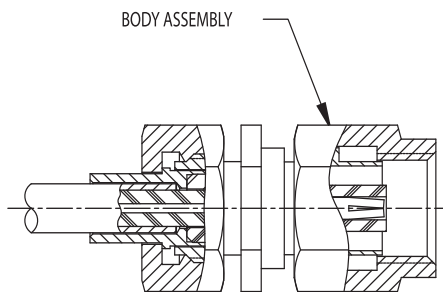

4. ASSEMBLE SLEEVE ASSEMBLY TO BODY. SLIDE CLAMP NUT FORWARD AND CLAMP SLEEVE TO BODY. TORQUE CLAMP NUT TO 8 IN.-LBS.



1. TRIM CABLE TO DIMENSIONS SHOWN. DO NOT NICK THE CENTER CONDUCTOR.



2. SLIDE CLAMP NUT OVER CABLE. INSERT CABLE INTO SLEEVE DIELECTRIC MUST PASS THROUGH HOLE IN SLEEVE. CABLE JACKET MUST BUTT AGAINST SHOULDER INSIDE SLEEVE. SOLDER CABLE INTO SLEEVE. CLEAN.

3. SOLDER CONDUCTOR INTO SLOT IN CONTACT THROUGH REAR ACCESS HOLE. CLEAN.



4. ASSEMBLE SLEEVE ASSEMBLY TO BODY. SLIDE CLAMP NUT FORWARD AND CLAMP SLEEVE TO BODY. TORQUE CLAMP NUT TO 8 IN.-LBS. PRESS CAP INTO BODY.

| PART NUMBER | | | FERRULE HEX SIZE |
|--------------|--------------|--------------|------------------|
| 510-800-0360 | 511-680-0360 | 511-880-0360 | .105 |
| 510-800-0630 | 511-680-0630 | 511-880-0630 | .128 |
| 510-800-0631 | 511-680-0361 | 511-880-0631 | .151 |



1. TRIM CABLE TO DIMENSIONS SHOWN. DO NOT NICK CENTER CONDUCTOR.



2. SLIDE SHRINK TUBING, FERRULE, AND CLAMP NUT OVER CABLE. INSERT CABLE INTO WEDGE ASSEMBLY. CENTER CONDUCTOR MUST ENTER AND PROTRUDE THROUGH HOLE IN INSULATOR. DIELECTRIC OF CABLE MUST BUTT AGAINST INSULATOR IN WEDGE. ASSEMBLE CENTER CONTACT TO WEDGE ASSEMBLY BY INSERTING CONTACT INTO HOLE IN INSULATOR. SOLDER CONTACT TO CENTER CONDUCTOR THROUGH HOLE IN CONTACT. CLEAN.

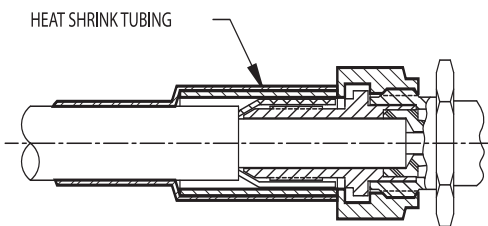

3. ASSEMBLE WEDGE ASSEMBLY TO BODY. SLIDE CLAMP NUT FORWARD AND CLAMP WEDGE TO BODY. TORQUE CLAMP NUT TP 8 IN.-LBS. SLIDE FERRULE FORWARD AND CRIMP. SLIDE SHRINK TUBING FORWARD AND HEAT SHRINK.

| PART NUMBER | "A" DIM | "B" DIM | "C" DIM | GAP | FERRULE HEX SIZE | |
|--------------|--------------|---------|---------|------|------------------|------|
| 250-900-0630 | .250 | .040 | .110 | .000 | .128 | |
| 250-900-0631 | .250 | .040 | .110 | .000 | .151 | |
| 250-900-1160 | 250-900-1161 | .190 | .000 | .100 | .000 | .213 |
| 251-975-0630 | .380 | .160 | .110 | .015 | .128 | |
| 251-975-0631 | .380 | .160 | .110 | .015 | .151 | |
| 251-975-1160 | 251-975-1161 | .300 | .110 | .100 | .000 | .213 |
| 350-900-0630 | .270 | .060 | .110 | .000 | .128 | |
| 350-900-0631 | .270 | .060 | .110 | .000 | .151 | |
| 350-900-1160 | 350-900-1161 | .218 | .000 | .090 | .000 | .213 |
| 351-900-0630 | .320 | .110 | .110 | .019 | .128 | |
| 351-900-0631 | .320 | .110 | .110 | .019 | .151 | |
| 351-900-1160 | 351-900-1161 | .302 | .092 | .125 | .000 | .213 |
| 351-975-0630 | .270 | .000 | .140 | .000 | .128 | |
| 351-975-0631 | .270 | .000 | .140 | .000 | .151 | |
| 351-975-1160 | 351-975-1161 | .300 | .110 | .100 | .000 | .213 |



1. TRIM CABLE TO DIMENSIONS SHOWN. DO NOT NICK CENTER CONDUCTOR.



2. SLIDE FERRULE OVER CABLE. SOLDER CENTER CONTACT TO CENTER CONDUCTOR THROUGH HOLE IN CONTACT. CONTACT MUST BUTT AGAINST DIELECTRIC. CLEAN.



3. SLIDE FERRULE FORWARD OVER BRAID AND CRIMP. SHRINK SLEEVING OVER FERRULE AND CABLE.



| PART NUMBER | | FIG. | FERRULE HEX SIZE |
|--------------|--------------|------|------------------|
| 252-900-0630 | | 3B | .128 |
| 252-900-0631 | | 3B | .151 |
| 252-900-1160 | 252-900-1161 | 3B | .213 |
| 352-900-0630 | | 3A | .128 |
| 352-900-0631 | | 3A | .151 |
| 352-900-1160 | 352-900-1161 | 3A | .213 |

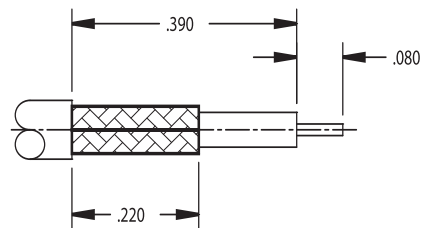

1. TRIM CABLE TO DIMENSIONS SHOWN. DO NOT NICK CENTER CONDUCTOR.

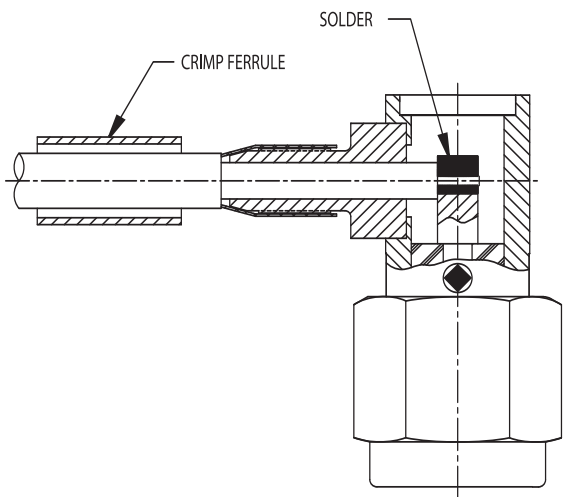

2. SLIDE FERRULE OVER CABLE. INSERT CABLE INTO WEDGE. CENTER CONDUCTOR MUST ENTER SLOT IN CENTER CONTACT. DIELECTRIC OF CABLE MUST BUTT AGAINST CONTACT. SOLDER CENTER CONDUCTOR INTO SLOT IN CONTACT. CLEAN.

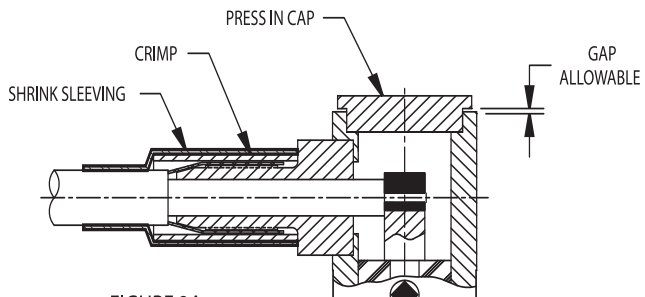

3. SLIDE FERRULE FORWARD AND CRIMP. PRESS OR SOLDER CAP INTO BODY PER FIG. 1 OR 2. NOTE: WHEN PRESSING IN CAP, DO NOT SEAT ON COUPLING NUT.

FIGURE 3A

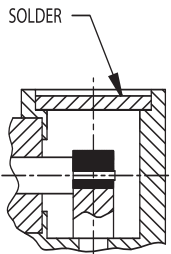
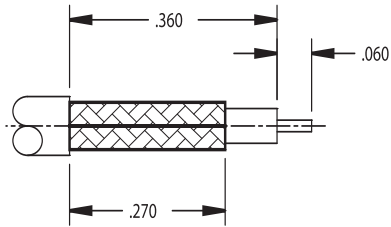

FIGURE 3B

4. SHRINK SLEEVING OVER FERRULE AND CABLE AS SHOWN.

| PART NUMBER | FERRULE HEX SIZE |
|--------------|------------------|
| 512-900-0360 | .105 |
| 512-900-0630 | .128 |
| 512-900-0631 | .151 |



1. TRIM CABLE TO DIMENSIONS SHOWN. DO NOT NICK CENTER CONDUCTOR.



2. SLIDE FERRULE OVER CABLE. INSERT CABLE INTO WEDGE. CENTER CONDUCTOR MUST ENTER SLOT IN CENTER CONTACT. DIELECTRIC OF CABLE MUST BUTT AGAINST CONTACT. SOLDER CENTER CONDUCTOR INTO SLOT IN CONTACT. CLEAN.



3. SLIDE FERRULE FORWARD AND CRIMP. PRESS CAP INTO BODY.

| PART NUMBER | CRIMP TOOL (CENTER CONTACT) | POSITIONER | TOOL SETTING |
|----------------|--------------------------------|------------|-----------------|
| 450-900-SERIES | T 2400 | P 0632 | 4 |
| 451-980-SERIES | | | |

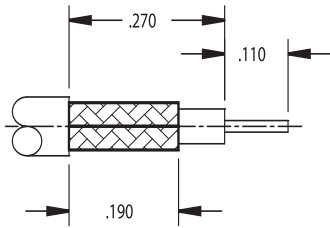

1. TRIM CABLE TO DIMENSIONS SHOWN. DO NOT NICK BRAIDS OR CENTER CONDUCTOR.



2. SLIDE FERRULE OVER BRAID. PLACE CENTER CONTACT INTO POSITIONER OF CRIMP TOOL (SEE TABLE FOR POSITIONER AND SETTING). INSERT CABLE CENTER CONDUCTOR INTO AND CRIMP. DIELECTRIC OF CABLE MUST BUTT AGAINST SHOULDER OF CONTACT. (NOTE: CENTER CONTACT MAY BE SOLDERED TO CENTER CONDUCTOR).



3. FLAIR BRAID. INSERT CENTER CONTACT INTO BODY UNTIL IT SNAPS INTO INSULATOR. BRAID WILL SIT OVER BARREL PORTION OF BODY.



4. SLIDE FERRULE FORWARD OVER BRAID AND CRIMP WITH APPROPRIATE HEX CRIMP DIE.

| PART NUMBER | FERRULE HEX SIZE |
|--------------|------------------|
| 452-900-0360 | .105 |
| 452-900-0630 | .128 |
| 452-900-0631 | .151 |

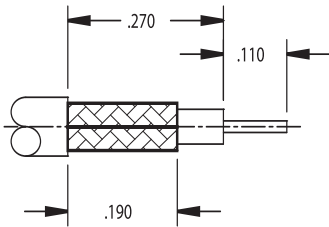

1. TRIM CABLE TO DIMENSIONS SHOWN. DO NOT NICK BRAIDS OR CENTER CONDUCTOR.



2. SLIDE FERRULE OVER BRAID. FLAIR BRAID AND INSERT INTO BODY. CENTER CONDUCTOR MUST ENTER SLOT IN CONTACT. SOLDER CONTACT. CLEAN.

3. SLIDE FERRULE FORWARD OVER BRAID AND CRIMP WITH APPROPRIATE HEX CRIMP DIE.



4. PLACE INSULATOR INTO ACCESS HOLE OVER CENTER CONTACT.

| PART NUMBER | | DIM A | DIM B | DIM C | HEX SIZE |
|--------------|--------------|------------|------------|------------|-------------|
| 360-900-0630 | 360-974-0630 | .200 [5.1] | .220 [5.6] | .100 [2.5] | .128 [3.25] |
| 361-922-0630 | | .200 [5.1] | .220 [5.6] | .100 [2.5] | .128 [3.25] |



FIGURE 1

1. TRIM CABLE TO DIMENSIONS SHOWN. DO NOT NICK BRAID OR CENTER CONDUCTOR. (SEE FIG. 1)

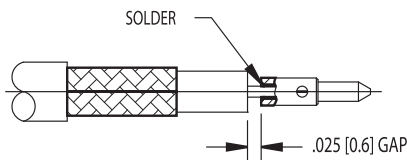

FIGURE 2

2. SLIDE CENTER CONDUCTOR OF CABLE INTO REAR CONTACT. SET GAP BETWEEN CONTACT AND DIELECTRIC OF CABLE. SOLDER. CLEAN. (SEE FIG. 2)

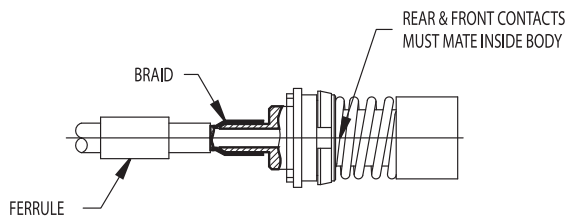

FIGURE 3

3. SLIDE FERRULE ONTO CABLE. FLAIR BRAID. INSERT CABLE INTO BODY, ALLOWING BRAID TO SLIDE OVER OUTSIDE OF BODY. INSERT CABLE UNTIL DIELECTRIC BUTTS AGAINST INSULATOR INSIDE BODY. REAR CONTACT MUST ENGAGE WITH FRONT CONTACT INSIDE BODY. (SEE FIG. 3)

4. SLIDE FERRULE FORWARD OVER BRAID, UP TO SHOULDER AND CRIMP.

| PART NUMBER | DIM A | DIM B | DIM C | HEX SIZE |
|--------------|------------|------------|------------|-------------|
| 362-974-0630 | .200 [5.1] | .310 [7.9] | .100 [2.5] | .128 [3.25] |
| 363-922-0630 | .200 [5.1] | .330 [8.4] | .100 [2.5] | .128 [3.25] |



FIGURE 1

1. TRIM CABLE TO DIMENSIONS SHOWN. DO NOT NICK BRAID OR CENTER CONDUCTOR. (SEE FIG. 1)

2. SLIDE FERRULE ONTO CABLE. FLAIR BRAID. INSERT CABLE INTO BODY, ALLOWING BRAID TO SLIDE OVER OUTSIDE OF BODY. CENTER CONDUCTOR MUST ENTER SLOT IN CENTER CONTACT. SOLDER CENTER CONDUCTOR TO CONTACT. CLEAN. (SEE FIG. 2)



FIGURE 2

3. SLIDE FERRULE FORWARD OVER BRAID, UP TO SHOULDER AND CRIMP.

4. PLACE CAP INTO BODY AS SHOWN AND DEPRESS CAP TO EXPAND INSIDE COUNTERBORE OF BODY. (SEE FIG. 2)

| PART NUMBER | | A | B | FERRULE HEX SIZE |
|--------------|--------------|------|------|------------------|
| 470-900-0360 | 471-900-0360 | .190 | .225 | .105 |
| 470-900-0630 | 471-900-0630 | .190 | .225 | .128 |



1. Trim cable to dimensions shown. Do not nick center conductor.



2. Slide ferrule over jacket. Insert center conductor of cable into contact. Dielectric of cable must butt against contact. Solder contact to center conductor. Clean.



3. Flair braid. Insert center contact into body until it snaps into insulator.

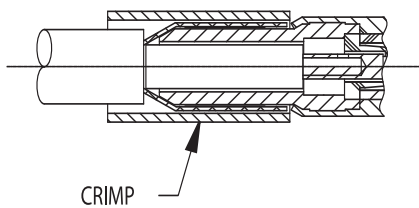

4. Slide ferrule over braid up to the shoulder of body. Crimp ferrule to retain braid. See table for hex sizes.

| PART NUMBER | A | B | FERRULE HEX SIZE |
|--------------|------|------|------------------|
| 472-900-0360 | .190 | .225 | .105 |
| 472-900-0630 | .190 | .225 | .128 |



1. Trim cable to dimensions shown. Tin the center conductor.



2. Slide ferrule over jacket. Flair braid. Insert cable into body. Center conductor must enter slot in contact. Solder contact. Clean.

3. Slide ferrule over braid up to the shoulder of body. Crimp ferrule to retain braid. See table for hex sizes.



4. Press cap into body.



1. STRIP CABLE TO DIMENSIONS AS SHOWN.



3. SLIDE CABLE INTO BODY, CENTER CONDUCTOR TO ENTER PREASSEMBLED SOCKET CONTACT, UNTIL CABLE DIELECTRIC BOTTOMS AGAINST INSULATOR. SLIDE FERRULE OVER BRAID UP TO THE SHOULDER OF BODY.

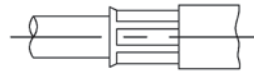

4. CRIMP THE FERRULE WITH HEX DIE.

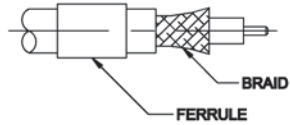

2. SLIDE FERRULE OVER JACKET. FLARE BRAID.

STRIP AND HEX DIE CHART:

| PART NUMBER | A | B | C | HEX DIE |
|----------------|------|------|------|---------|
| 0345-E00-28C01 | .155 | .312 | .624 | .192 |
| 0345-E00-C7201 | | | | .178 |



1. STRIP CABLE TO DIMENSIONS AS SHOWN.



2. SLIDE FERRULE OVER JACKET. FLARE BRAID.

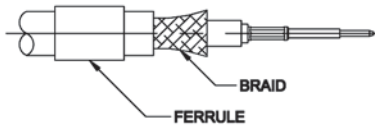

3. CRIMP (OR SOLDER) CONTACT TO CABLE USING A .042" HEX DIE.

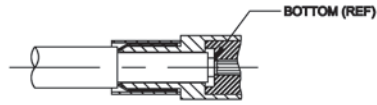

4. SLIDE CABLE INTO BODY UNTIL CABLE DIELECTRIC BOTTOMS AGAINST INSULATOR. SLIDE FERRULE OVER BRAID UP TO THE SHOULDER OF BODY.



5. CRIMP THE FERRULE WITH HEX DIE.

STRIP AND HEX DIE CHART:

| PART NUMBER | A | B | C | HEX DIE |
|----------------|------|------|------|---------|
| 0345-E00-C7202 | .150 | .327 | .625 | .042 |
| | | | | .178 |



1. Cut cable end square, place clamp-nut, slip washer (when supplied), and gasket over jacket. Remove jacket to dimension "A."



2. Comb out braid and taper forward. Place braid clamp over braid against jacket cut.



3. Fold braid back over braid clamp and trim as shown above. Remove dielectric to dimension "B." Cut center conductor to dimension "C."
When cable positioning insulators are used adjust trim code dimensions as shown below, and assemble as indicated.



4. Solder contact to center conductor. For access type angle connectors, omit this step and proceed to step 5.
For captive contacts: (a) assemble bushing and insulator, attach contact, or (b) assemble washer and larger (cable end) insulator. Attach contact. Assemble smaller (mating end) insulator.
When center contact is undercut captive type, insert cable assembly until insulator detent locks into contact.

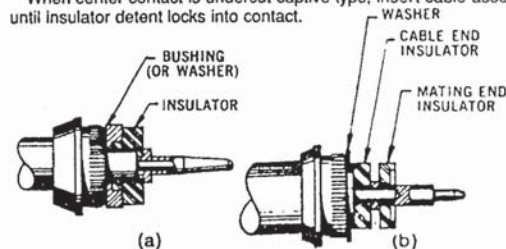

5. Thread assembly into connector, and lock securely. Vee gasket must be split by braid clamp.



6. For access type angle connectors, solder center conductor in contact groove. Close access opening.

| TRIM CODE CHART | | | |
|-----------------|-------|------|------|
| CODE | A | B | C |
| 1001 | 11/16 | .440 | 7/64 |
| 1002 | 23/32 | .470 | 7/64 |
| 1003 | 11/16 | .420 | 1/8 |
| 1004 | 11/32 | .106 | 7/64 |
| 1005 | 11/32 | .040 | 5/32 |
| 1008 | 3/8 | .180 | 1/16 |
| 1012 | 13/32 | .128 | 5/32 |
| 1013 | 7/16 | .170 | 5/32 |
| 1014 | 7/16 | .118 | 7/32 |
| 1015 | 3/8 | .118 | 5/32 |
| 1016 | 3/8 | .046 | 7/32 |
| 1017 | 13/32 | .074 | 3/16 |
| 1018 | 31/64 | .065 | 7/32 |
| 1019 | 5/8 | .371 | 5/32 |
| 1021 | 3/8 | .096 | 5/32 |
| 1022 | 5/16 | .046 | 5/32 |
| 1024 | 3/8 | .046 | 3/16 |
| 1025 | 13/32 | .216 | 3/32 |
| 1030 | 1/4 | .045 | 3/32 |
| 1031 | 5/8 | .296 | 7/32 |
| 1033 | 19/32 | .327 | 5/32 |
| 1042 | 5/16 | .070 | 1/8 |
| 1044 | 5/16 | .105 | 9/64 |
| 1050 | 19/64 | .109 | 7/64 |

CLAMP NUT
SLIP WASHER (WHEN SUPPLIED)
VEE-GASKET

1. Cut cable end square, place clamp-nut, slip washer (when supplied), and gasket over jacket. Remove jacket to dimension "A."

BRAID CLAMP

2. Comb out braid and taper forward. Place braid clamp over braid against jacket cut.

3. Fold braid back over braid clamp and trim as shown above. Remove dielectric to dimension "B." Cut center conductor to dimension "C."
When cable positioning insulators are used adjust trim code dimensions as shown below, and assemble as indicated.

1000.1

1000.2

SEMI-SOLID DIELECTRIC
1000.3

CONTACT

4. Solder or crimp contact to center conductor. For access type angle connectors, omit this step and proceed to step 5. For captive contacts, assemble contact capturing parts on cable before attaching contact as shown below.

BUSHING (OR WASHER)
INSULATOR

5. Thread assembly into connector, and lock securely. Vee gasket must be split by braid clamp.

CAP
SEAL
CONTACT

6. For access type angle connectors, solder center conductor in contact groove. Close access opening.

| TRIM CODE CHART | | | |
|-----------------|-----|------|------|
| CODE | A | B | C |
| 1006 | 3/4 | .531 | 7/64 |

1. Cut cable end square, place clamp-nut, slip washer (when supplied), and gasket over jacket. Remove jacket to dimension "A."

2. Comb out braid and taper forward. Place braid clamp over braid against jacket cut.

3. Fold braid back over braid clamp and trim as shown above. Remove dielectric to dimension "B." Cut center conductor to dimension "C."
When cable positioning insulators are used adjust trim code dimensions as shown below, and assemble as indicated.

1000.1 1000.2

SEMI-SOLID DIELECTRIC

1000.3

4. Solder or crimp contact to center conductor. For access type angle connectors, omit this step and proceed to step 5. For captive contacts, assemble contact capturing parts on cable before attaching contact as shown below.

5. Thread assembly into connector, and lock securely. Vee gasket must be split by braid clamp.

6. For access type angle connectors, solder center conductor in contact groove. Close access opening.

| TRIM CODE CHART | | | |
|-----------------|-----|------|------|
| CODE | A | B | C |
| 1040 | 3/8 | .070 | 5/32 |

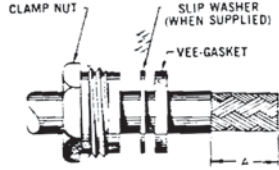

1. Cut cable end square, place clamp-nut, slip washer (when supplied), and gasket over jacket. Remove jacket to dimension "A."



2. Comb out braid and taper forward. Place braid clamp over braid against jacket cut.



3. Fold braid back over braid clamp and trim as shown above. Remove dielectric to dimension "B." Cut center conductor to dimension "C."
When cable positioning insulators are used adjust trim code dimensions as shown below, and assemble as indicated.

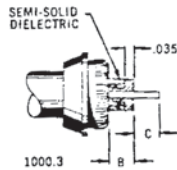
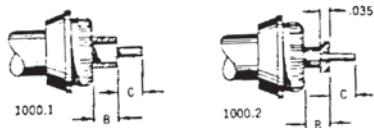

4. Solder or crimp contact to center conductor.
For access type angle connectors, omit this step and proceed to step 5.
For captive contacts, assemble contact capturing parts on cable before attaching contact as shown below.

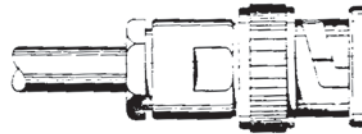

5. Thread assembly into connector, and lock securely. Vee gasket must be split by braid clamp.

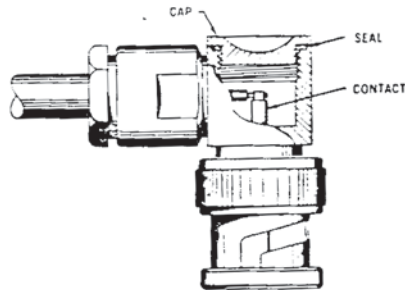

6. For access type angle connectors, solder center conductor in contact groove. Close access opening.

| TRIM CODE CHART | | | |
|-----------------|-----|------|------|
| CODE | A | B | C |
| 1052 | 1/2 | .140 | 7/32 |



1. Cut cable end square. Slide clamp nut, washer and gasket over jacket. Remove outer jacket to dimension "A."

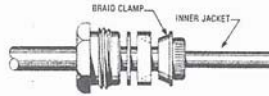

2. Place braid clamp over outer braid and against jacket cut. Comb out braid and fold back over braid clamp. Trim as shown.



3. Assemble retainer and insulator over inner jacket. Remove inner jacket to dimension "B."



4. Place braid clamp over inner braid and against inner jacket cut. Comb out braid and fold back over braid clamp. Trim even with base of braid clamp.

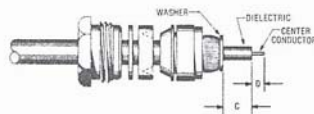

5. Place washer over dielectric against braid. Trim dielectric to dimension "C" and center conductor to dimension "D."



6. Solder center contact to center conductor.



7. Assemble inner insulator, contact and outer insulator, then insert into body. Slide back end parts forward. Thread assembly into connector body and lock securely.

| TRIM CODE CHART | | | | |
|-----------------|-----|------|------|------|
| CODE | A | B | C | D |
| 1301 | .69 | .096 | .210 | .094 |
| 1302 | .69 | .125 | .214 | .080 |
| 1303 | .69 | .096 | .166 | .141 |



1. Cut cable end square. Assemble O-ring. Slide clamp nut and gasket over jacket. Remove outer jacket to dimension "A."

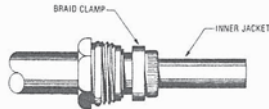

2. Place braid clamp over outer braid and against jacket cut. Comb out braid and fold back over braid clamp. Trim as shown.



3. Assemble retainer and insulator over inner jacket. Remove inner jacket to dimension "B."



4. Place braid clamp over inner braid and against inner jacket cut. Comb out braid and fold back over braid clamp. Trim even with base of braid clamp.



5. Place washer over dielectric against braid. Trim dielectric to dimension "C" and center conductor to dimension "D."



6. Solder center contact to center conductor.



7. Assemble inner insulator, contact and outer insulator, then insert into body. Slide back end parts forward. Thread assembly into connector body and lock securely.

TRIM CODE CHART

| CODE | A | B | C | D |
|-------|-------|------|------|------|
| 1301A | 11/16 | .096 | .210 | 3/32 |



1. CUT CABLE END SQUARE, SLIDE CLAMP NUT, WASHER AND VEE-GASKET OVER JACKET. REMOVE OUTER JACKET TO DIMENSION "A".

| TRIM CODE CHART | | | |
|-----------------|------|------|------|
| A | B | C | D |
| .69 | .096 | .102 | .094 |



2. PLACE BRAID CLAMP OVER OUTER BRAID AND AGAINST JACKET CUT. COMB OUT BRAID AND FOLD BACK OVER BRAID CLAMP. TRIM AS SHOWN.



3. ASSEMBLE RETAINER AND INSULATOR OVER INNER JACKET. REMOVE INNER JACKET TO DIMENSION "B".



4. PLACE SMALL BRAID CLAMP OVER INNER BRAID AND AGAINST INNER JACKET CUT. COMB OUT BRAID AND FOLD BACK OVER SMALL CLAMP. TRIM EVEN WITH BASE OF BRAID CLAMP.

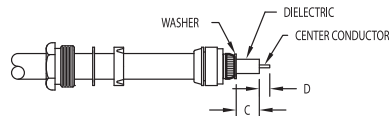

5. PLACE WASHER OVER DIELECTRIC AND AGAINST BRAID. TRIM DIELECTRIC TO DIMENSION "C" AND CENTER CONDUCTOR TO DIMENSION "D".

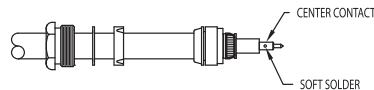

6. SOLDER CENTER CONTACT TO CENTER CONDUCTOR.



7. SLIDE BACK END PARTS FORWARD. ASSEMBLE INNER INSULATOR, INTERMEDIATE CONTACT AND OUTER INSULATOR. THREAD INTO CONNECTOR BODY AND TORQUE TO 30-35 IN.LBS.

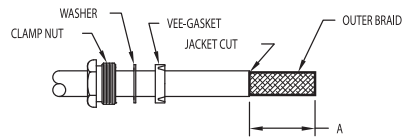

1. CUT CABLE END SQUARE, SLIDE CLAMP NUT, WASHER AND VEE-GASKET OVER JACKET. REMOVE OUTER JACKET TO DIMENSION "A".

| TRIM CODE CHART | | | |
|-----------------|------|------|------|
| A | B | C | D |
| .69 | .096 | .243 | .110 |



2. PLACE BRAID CLAMP OVER OUTER BRAID AND AGAINST JACKET CUT. COMB OUT BRAID AND FOLD BACK OVER BRAID CLAMP. TRIM AS SHOWN.



3. ASSEMBLE RETAINER AND INSULATOR OVER INNER JACKET. REMOVE INNER JACKET TO DIMENSION "B".



4. PLACE SMALL BRAID CLAMP OVER INNER BRAID AND AGAINST INNER JACKET CUT. COMB OUT BRAID AND FOLD BACK OVER SMALL CLAMP. TRIM EVEN WITH BASE OF BRAID CLAMP.

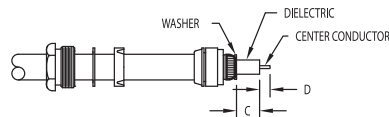

5. PLACE WASHER OVER DIELECTRIC AND AGAINST BRAID. TRIM DIELECTRIC TO DIMENSION "C" AND CENTER CONDUCTOR TO DIMENSION "D".

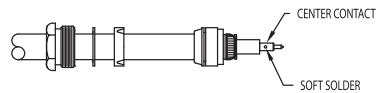

6. SOLDER CENTER CONTACT TO CENTER CONDUCTOR.



7. SLIDE BACK END PARTS FORWARD THREAD ASSEMBLY INTO CONNECTOR BODY AND TORQUE TO 35 IN LBS.

1. Cut cable end square. Slide cap over armor braid. Remove armor to dimension "A" and bulge back approximately 4".

2. Place clamp-nut, slip washer (when supplied), and gasket over jacket. Remove jacket to dimension "B."

3. Comb out braid and taper forward. Place braid clamp over braid against jacket cut.

4. Fold braid back over braid clamp and trim as shown above. Remove dielectric to dimension "C." Cut center conductor to dimension "D."

| TRIM CODE CHART | | | | |
|-----------------|--------|------|------|------|
| CODE | A | B | C | D |
| 1601 | 1-5/32 | 3/8 | .046 | 3/16 |
| 1606 | 1-1/8 | 9/32 | .040 | 1/8 |
| 1607 | 1-3/32 | 1/4 | .040 | 3/32 |
| 1608 | 1-5/32 | 3/8 | .046 | 7/32 |

5. Solder contact to center conductor. For captive contacts, assemble contact capturing parts on cable before attaching contact as shown below.

6. Thread assembly into connector, and lock securely. Vee gasket must be split by braid clamp.

7. Slide armor braid forward over tapered end of nut, and trim as shown. Tighten cap securely with wrench.

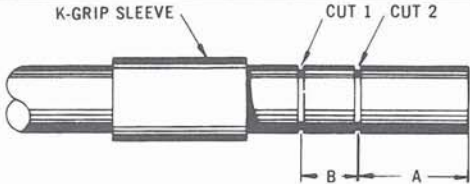

1. Cut cable end square, slide K-GRIP sleeve over jacket and make cuts 1 and 2 in jacket.

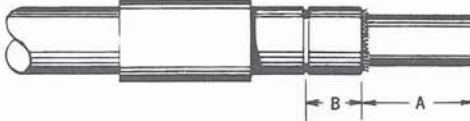

2. Remove jackets to dimension "A," flare or bulge back braid and trim with scissors at edge of jacket.

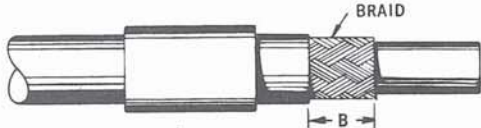

3. Remove jacket to dimension "B."

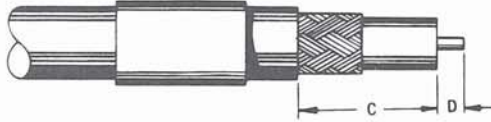

4. Using dielectric trim jig, trim dimension "C." Exposed center conductor length will be equal to dimension "D" of trim code.

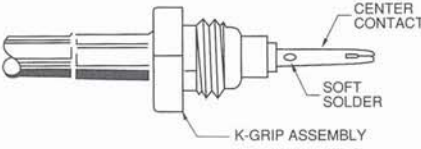

5. Push K-GRIP Jr. over dielectric and under braid until dielectric bottoms in connector. Slide K-GRIP sleeve against shoulder on body and form hex. Soft solder contact as shown.

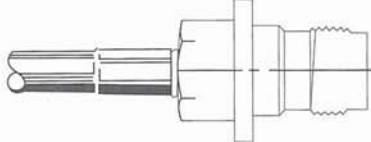

6. Thread assembly into connector, and lock securely.

| TRIM CODE CHART | | | | |
|-----------------|-------|------|------|------|
| CODE | A | B | C | D |
| 432 | 17/64 | 7/32 | .390 | 3/32 |
| 439 | 7/32 | 7/32 | .345 | 3/32 |
| 493 | 1/4 | 9/32 | .390 | .140 |
| 1901 | .510 | .220 | .450 | .280 |



1. Cut cable end square, slide K-GRIP sleeve and back end parts over jacket. Make cuts A and B in jacket.



2. Remove jacket to dimension "A." Flare or bulge back braid. Trim with scissors at edge of jacket.



3. Remove jacket to dimension "B." Push K-GRIP over dielectric and under braid. Slide jacket gasket, when provided, forward to position flush with jacket edge. (When the "B" dimension in the trim code is 0, push the K-GRIP under both braid and jacket, butting braid against flange of K-GRIP. Teflon jackets may be slit axially 1/4" in the two places to facilitate entry of the K-GRIP.



4. Slide K-GRIP sleeve against flange on K-GRIP Form hex.



5. Trim dielectric to dimension "C." Cut center conductor to dimension "D." Assemble internal O-ring seals and spacer, when provided, as shown below. When cable positioning insulators are used, adjust trim code dimensions as shown below, and assemble as indicated.

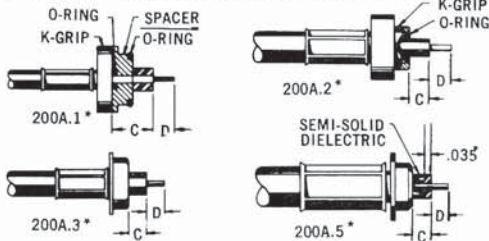

*Use appropriate dimensions from trim code chart at right.



6. Solder or crimp contact to center conductor. For access type angle connectors, omit this step and proceed to step 7.

For captive contacts: (a) assemble bushing and insulator. Attach contact or (b) assemble washer and larger (cable end) insulator. Attach contact. Assemble smaller (mating end) insulator.

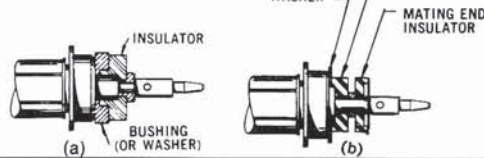

7. Thread assembly into connector and lock securely. Vee gasket must be split by braid clamp.



8. For access type angle connectors, solder center conductor in contact groove. Close access opening.

TRIM CODE CHART

| CODE | A | B | C | D |
|------|-------|------|------|------|
| 201A | 1/2 | 7/32 | .110 | 7/64 |
| 204A | 5/8 | 7/32 | .118 | 7/32 |
| 207A | 9/16 | 7/32 | .118 | 5/32 |
| 208A | 29/32 | 7/32 | .298 | 7/32 |
| 209A | 19/32 | 7/32 | .043 | 5/32 |
| 211A | 35/64 | 7/32 | .045 | 7/64 |
| 225A | 3/8 | 0 | .106 | 7/64 |
| 226A | 9/16 | 3/16 | .111 | 7/64 |
| 227A | 45/64 | 3/16 | .170 | 3/32 |
| 228A | 37/64 | 3/16 | .244 | 7/64 |
| 230A | 19/32 | 7/32 | .043 | 3/16 |
| 243A | 9/32 | 0 | .053 | 5/64 |

1. Cut cable end square and slide clamp nut onto outer conductor.

2. Remove outer conductor to dimension "A" and dielectric to dimension "B."



3. Insert cable into adapter assembly until bottomed. Soft solder outer conductor then center conductor as shown.



4. With connector body assembly mounted on bulkhead, insert cable assembly and lock securely with clamp nut.

TRIM CODE CHART

| CODE | A | B |
|------|-----|------|
| 2101 | 3/8 | .125 |

1. Cut cable end square, slide K-GRIP sleeve and back end parts over jacket. Using jacket trim jig, make cuts A and B in jacket.

2. Remove jacket to dimension "A." Flare or bulge back braid. Trim with scissors at edge of jacket.

3. Remove jacket to dimension "B." Push K-GRIP over dielectric and under braid. Slide jacket gasket, when provided, forward to position flush with jacket edge. (When the "B" dimension in the trim code is 0, push the K-GRIP under both braid and jacket, butting braid against flange of K-GRIP. Teflon jackets may be slit axially 1/4" in the two places to facilitate entry of the K-GRIP.)

4. Slide K-GRIP sleeve against flange on K-GRIP. Form hex.

5. With dielectric trim jig, trim dielectric to dimension "C." Cut center conductor to dimension "D." Assemble internal O-ring seals and spacer, when provided, as shown below. When cable positioning insulators are used, adjust trim code dimensions as shown below, and assemble as indicated.



6. Solder or crimp contact to center conductor. For access type angle connectors, omit this step and proceed to step 7.
For captive contacts: (a) assemble bushing and insulator. Attach contact or (b) assemble washer and larger (cable end) insulator. Attach contact. Assemble smaller (mating end) insulator.

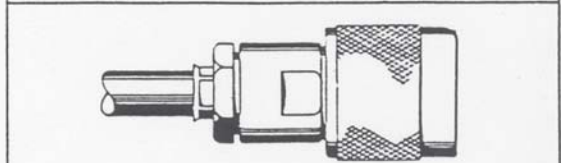
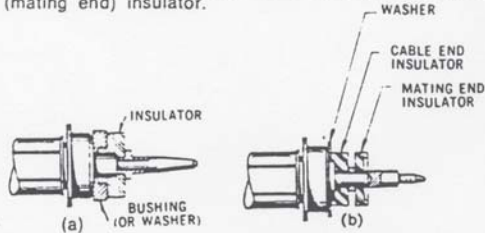

7. Thread assembly into connector and lock securely. Vee gasket must be split by braid clamp.

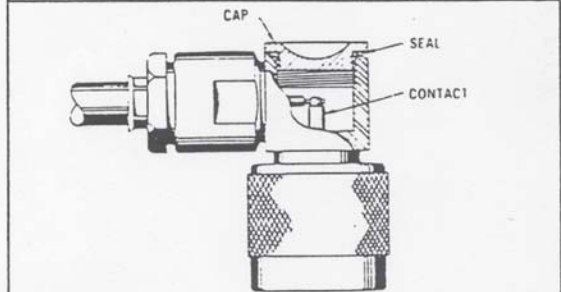

8. For access type angle connectors, solder center conductor in contact groove. Close access opening.

| TRIM CODE CHART | | | | |
|-----------------|-------|------|------|------|
| CODE | A | B | C | D |
| 213A | 21/32 | 7/32 | .041 | 7/32 |

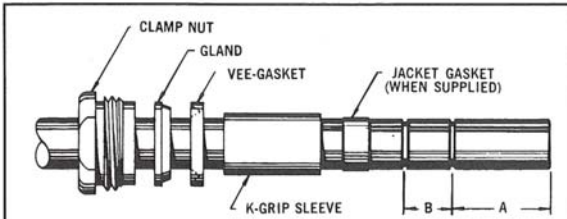

1. Cut cable end square, slide K-GRIP sleeve and back end parts over jacket. Make cuts A and B in jacket.



2. Remove jacket to dimension "A." Flare or bulge back braid. Trim with scissors at edge of jacket.



3. Remove jacket to dimension "B." Push K-GRIP over dielectric and under braid. Slide jacket gasket, when provided, forward to position flush with jacket edge. (When the "B" dimension in the trim code is 0, push the K-GRIP under both braid and jacket, butting braid against flange of K-GRIP. Teflon jackets may be slit axially 1/4" in the two places to facilitate entry of the K-GRIP.



4. Slide K-GRIP sleeve against flange on K-GRIP Form hex.



5. Trim dielectric to dimension "C." Cut center conductor to dimension "D." Assemble internal O-ring seals and spacer, when provided, as shown below. When cable positioning insulators are used, adjust trim code dimensions as shown below, and assemble as indicated.



*Use appropriate dimensions from trim code chart at right.



6. Solder or crimp contact to center conductor. For access type angle connectors, omit this step and proceed to step 7.

For captive contacts: (a) assemble bushing and insulator. Attach contact or (b) assemble washer and larger (cable end) insulator. Attach contact. Assemble smaller (mating end) insulator.



7. Thread assembly into connector and lock securely. Vee gasket must be split by braid clamp.



8. For access type angle connectors, solder center conductor in contact groove. Close access opening.

TRIM CODE CHART

| CODE | A | B | C | D |
|------|-------|------|------|------|
| 201A | 1/2 | 7/32 | .110 | 7/64 |
| 204A | 5/8 | 7/32 | .118 | 7/32 |
| 207A | 9/16 | 7/32 | .118 | 5/32 |
| 208A | 29/32 | 7/32 | .298 | 7/32 |
| 209A | 19/32 | 7/32 | .043 | 5/32 |
| 211A | 35/64 | 7/32 | .045 | 7/64 |
| 225A | 3/8 | 0 | .106 | 7/64 |
| 226A | 9/16 | 3/16 | .111 | 7/64 |
| 227A | 45/64 | 3/16 | .170 | 3/32 |
| 228A | 37/64 | 3/16 | .244 | 7/64 |
| 230A | 19/32 | 7/32 | .043 | 3/16 |
| 243A | 9/32 | 0 | .053 | 5/64 |



1. Cut cable end square, slide K-GRIP sleeve and back end parts over jacket. Using jacket trim jig, make cuts A and B in jacket.



2. Remove jacket to dimension "A." Flare or bulge back braid. Trim with scissors at edge of jacket.



3. Remove jacket to dimension "B." Push K-GRIP over dielectric and under braid. Slide jacket gasket, when provided, forward to position flush with jacket edge. (When the "B" dimension in the trim code is 0, push the K-GRIP under both braid and jacket, butting braid against flange of K-GRIP. Teflon jackets may be slit axially 1/4" in the two places to facilitate entry of the K-GRIP.)

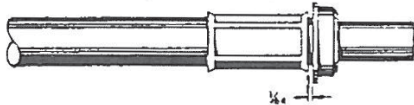

4. Slide K-GRIP sleeve against flange on K-GRIP. Form hex.



5. With dielectric trim jig, trim dielectric to dimension "C." Cut center conductor to dimension "D." Assemble internal O-ring seals and spacer, when provided, as shown below. When cable positioning insulators are used, adjust trim code dimensions as shown below, and assemble as indicated.



6. Solder or crimp contact to center conductor. For access type angle connectors, omit this step and proceed to step 7.

For captive contacts: (a) assemble bushing and insulator. Attach contact or (b) assemble washer and larger (cable end) insulator. Attach contact. Assemble smaller (mating end) insulator.

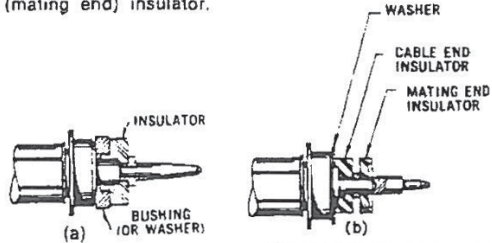

7. Thread assembly into connector and lock securely. Vee gasket must be split by braid clamp.



8. For access type angle connectors, solder center conductor in contact groove. Close access opening.

TRIM CODE CHART

| CODE | A | B | C | D |
|------|-------|------|------|------|
| 239A | 29/32 | 7/32 | .294 | 9/32 |

CP-3800

1. Trim cable using indicated trim tool.



A. Cut cable end square and score outer conductor all around to dimension indicated.



B. Remove jacket to scored mark with pliers. Then remove dielectric to front face of outer conductor making sure surface is square and free of burrs. Do not nick center conductor.

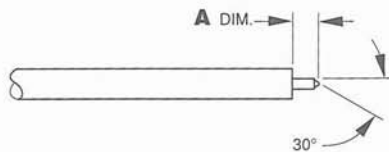

C. File end of center conductor as shown, to approximately 30°.

2. Insert trimmed end of cable into back end of connector, until cable bottoms.

3. Put an interface fixture on the mating end to prevent movement of the interface while soldering.



4. Place cable, connector and interface fixture in a non-destructive clamping mechanism.

5. Set fixture in vertical position shown.

6. Apply a small amount of liquid rosin flux to cable/connector joint (point A).

7. Apply heat at point B using resistance type heat tweezers or other similar device that will not leave burn marks or solder residue on the connector body.

8. Apply solder at point A, forming a smooth continuous joint free of voids.

9. Allow to cool.

10. Clean off excess flux using alcohol or a freon based flux cleaner.

TRIM CODE CHART

| CODE | A DIM. | TRIM TOOL |
|--------|-----------|-----------|
| 3800-1 | .090/.080 | KTO-2A |
| 3800-2 | .075/.065 | KTO-3A |



| TRIM CODE CHART | | | | |
|-----------------|---------|-------|-------|-------|
| CODE | A | B | C | D |
| 401 | 23/64 | 7/32 | .468 | 7/64 |
| 402 | 11/32 | 7/32 | .375 | 3/16 |
| 403 | 7/16 | 7/32 | .493 | 5/32 |
| 405 | 49/64 | 7/32 | .871 | 7/64 |
| 406 | 9/32 | 0 | .093 | 3/16 |
| 407 | 11/16 | 0 | .496 | 3/16 |
| 408 | 45/64 | 7/32 | .809 | 7/64 |
| 409 | 19/64 | 3/16 | .406 | 7/64 |
| 410 | 31/32 | 7/32 | .562 | 5/8 |
| 413 | 21/32 | 7/32 | .717 | 5/32 |
| 414 | 29/64 | 7/32 | .556 | 7/64 |
| 415 | 15/32 | 3/16 | .530 | 5/32 |
| 417 | 41/64 | 7/32 | .743 | 7/64 |
| 418 | 45/64 | 7/32 | .809 | 7/64 |
| 419 | 7/8 | 7/32 | .984 | 7/64 |
| 421 | 15/64 | 0 | .150 | 5/64 |
| 424 | 11/32 | 7/32 | .450 | 7/64 |
| 426 | 17/64 | 7/32 | .406 | 5/64 |
| 430 | 1/2 | 0 | .211 | 1/4 |
| 431 | 9/16 | 0 | .366 | 3/16 |
| 432 | 17/64 | 7/32 | .390 | 3/32 |
| 433 | 5/16 | 7/32 | .375 | 5/32 |
| 435 | 25/64 | 7/32 | .524 | 5/64 |
| 436 | 35/64 | 7/32 | .512 | 1/4 |
| 439 | 7/32 | 7/32 | .345 | 3/32 |
| 440 | 11/32 | 7/32 | .480 | 5/64 |
| 441 | 23/32 | 7/32 | .772 | 5/32 |
| 447 | 1-1/64 | 7/32 | .953 | 9/32 |
| 451 | 1-5/64 | 7/32 | 1.018 | 9/32 |
| 452 | 1-3/32 | 7/32 | .690 | 5/8 |
| 457 | 45/64 | 7/32 | .764 | 5/32 |
| 458 | 5/8 | 7/32 | .671 | 11/64 |
| 459 | 39/64 | 7/32 | .638 | 3/16 |
| 462 | 5/16 | 7/32 | .437 | 3/32 |
| 464 | 15/32 | 7/32 | .493 | 3/16 |
| 465 | 1/4 | 11/32 | .432 | 5/32 |
| 468 | 25/64 | 7/32 | .501 | 3/32 |
| 469 | 1/2 | 7/32 | .580 | 9/64 |
| 470 | 13/32 | 7/32 | .462 | 5/32 |
| 474 | 15/16 | 3/16 | .890 | 15/64 |
| 475 | 1-3/4 | 3/16 | 1.627 | 5/16 |
| 477 | 19/64 | 9/32 | .468 | 7/64 |
| 480 | .281 | .406 | .500 | .187 |
| 484 | 1-13/64 | 7/32 | .948 | 15/64 |
| 487 | 27/64 | 7/32 | .550 | 3/32 |
| 488 | 45/64 | 7/32 | .316 | 39/64 |
| 489 | 11/32 | 11/32 | .500 | 3/16 |
| 493 | 1/4 | 9/32 | .390 | .140 |
| 498 | 23/64 | 7/32 | .316 | 17/64 |
| 5401 | 5/16 | 9/32 | .432 | 5/32 |
| 5402 | 3/8 | 5/16 | .500 | 3/16 |
| 5403 | 5/8 | 5/16 | .750 | 3/16 |
| 5406 | 13/32 | 9/32 | .500 | 3/16 |
| 5407 | 5/16 | 1/4 | .437 | 1/8 |
| 5416 | 3/4 | 0 | .560 | 3/16 |
| 5417 | 19/32 | 1/4 | .703 | 9/64 |
| 5425 | 5/16 | 0 | .187 | 1/8 |
| 5457 | 5/16 | 5/16 | 15/32 | 5/32 |



1. Cut cable end square, slide K-GRIP sleeve over jacket and with jacket trim jig make cuts 1 and 2 in jacket



2. Remove jackets to dimension "A," flare or bulge back braid and trim with scissors at edge of jacket.



3. Remove jacket to dimension "B."



4. Using dielectric trim jig, trim dimension "C." Exposed center conductor length will be equal to dimension "D" of trim code.



5. Solder or crimp contact to center conductor.

5A. For 10 & 20 KV connectors, when Cable Seal Gasket is supplied, place over center conductor and against cable dielectric. Solder contact to center conductor with gasket under compression.

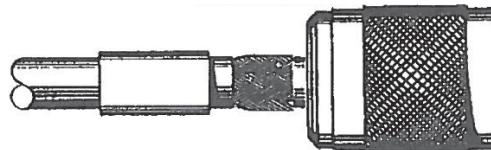

6. Push K-GRIP Jr. over dielectric and under braid until dielectric bottoms in connector. When the "B" dimension in the trim code is 0, the K-GRIP Jr. is pushed under both braid and jacket. Teflon jackets may be slit axially 1/4" in two places to facilitate entry of the K-GRIP. When center contact is undercut captive type, insert cable assembly until insulator detent locks into contact.

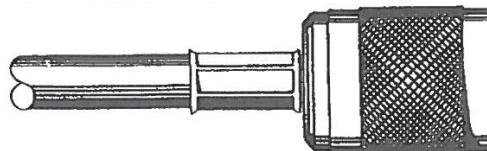

7. Slide K-GRIP sleeve against shoulder on body and form hex by crimping.

| TRIM CODE CHART | | | | |
|-----------------|-----|------|------|------|
| CODE | A | B | C | D |
| 412 | 5/8 | 7/32 | .680 | 5/32 |

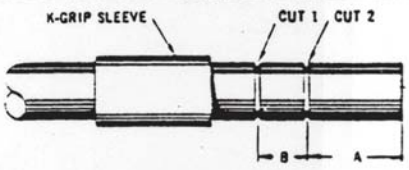

1. Cut cable end square, slide K-GRIP sleeve over jacket and with jacket trim jig make cuts 1 and 2 in jacket.

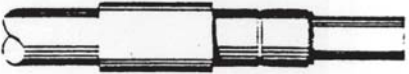

2. Remove jacket to dimension "A," flare or bulge back braid and trim with scissors at edge of jacket.



3. Remove jacket to dimension "B."

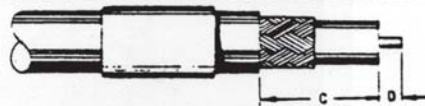

4. Using dielectric trim jig, trim dimension "C." Exposed center conductor length will be equal to dimension "D" of trim code.



5. Solder or crimp contact to center conductor.

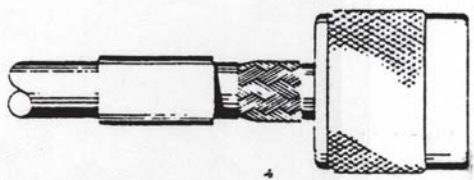

6. Push K-GRIP, Jr. over dielectric and under braid until dielectric bottoms in connector, or, for small cable, until shoulder on center contact bottoms against contact positioning jig.

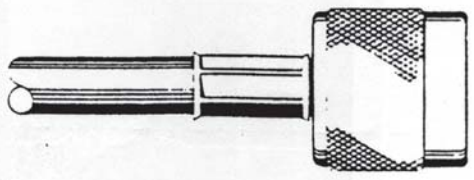

7. Slide K-GRIP sleeve against shoulder on body and form hex by crimping.

| TRIM CODE CHART | | | | |
|-----------------|-------|------|------|------|
| CODE | A | B | C | D |
| 416 | 25/64 | 7/32 | .453 | 5/32 |

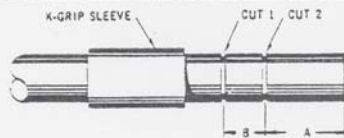

1. Cut cable end square, slide K-GRIP sleeve over jacket and with jacket trim jig make cuts 1 and 2 in jacket.



2. Remove jacket to dimension "A," flare or bulge back braid and trim with scissors at edge of jacket.



3. Remove jacket to dimension "B."

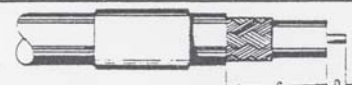

4. Using dielectric trim jig, trim dimension "C." Exposed center conductor length will be equal to dimension "D" of trim code.



5. Solder ~~contact~~ contact to center conductor.

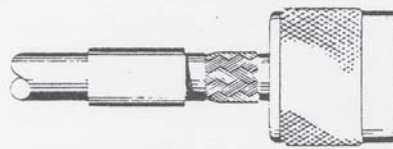

6. Push K-GRIP, Jr. over dielectric and under braid until dielectric bottoms in connector, or, for small cable, until shoulder on center contact bottoms against contact positioning jig.

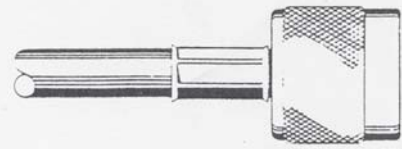

7. Slide K-GRIP sleeve against shoulder on body and form hex by crimping.

| TRIM CODE CHART | | | | |
|-----------------|-----|------|------|-----|
| CODE | A | B | C | D |
| 420 | 5/8 | 7/32 | .600 | 1/4 |

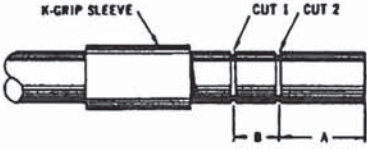

1. Cut cable end square, slide K-GRIP sleeve over jacket and with jacket trim jig make cuts 1 and 2 in jacket.



2. Remove jackets to dimension "A," flare or bulge back braid and trim with scissors at edge of jacket.



3. Remove jacket to dimension "B."



4. Using dielectric trim jig, trim dimension "C." Exposed center conductor length will be equal to dimension "D" of trim code.



5. Solder or crimp contact to center conductor.

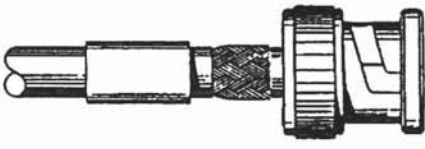

6. Push K-GRIP Jr. over dielectric and under braid until dielectric bottoms in connector. When the "B" dimension in the trim code is 0, the K-GRIP Jr. is pushed under both braid and jacket. Teflon jackets may be slit axially 1/4" in two places to facilitate entry of the K-GRIP.

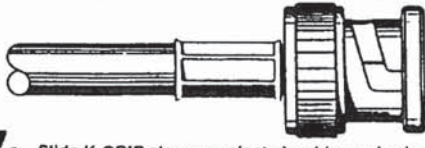

7. Slide K-GRIP sleeve against shoulder on body and form hex.
For captive contact connectors, solder contact to center conductor and thread assembly into connector.

| TRIM CODE CHART | | | | |
|-----------------|-------|---|------|------|
| CODE | A | B | C | D |
| 425 | 19/32 | 0 | .316 | 9/32 |

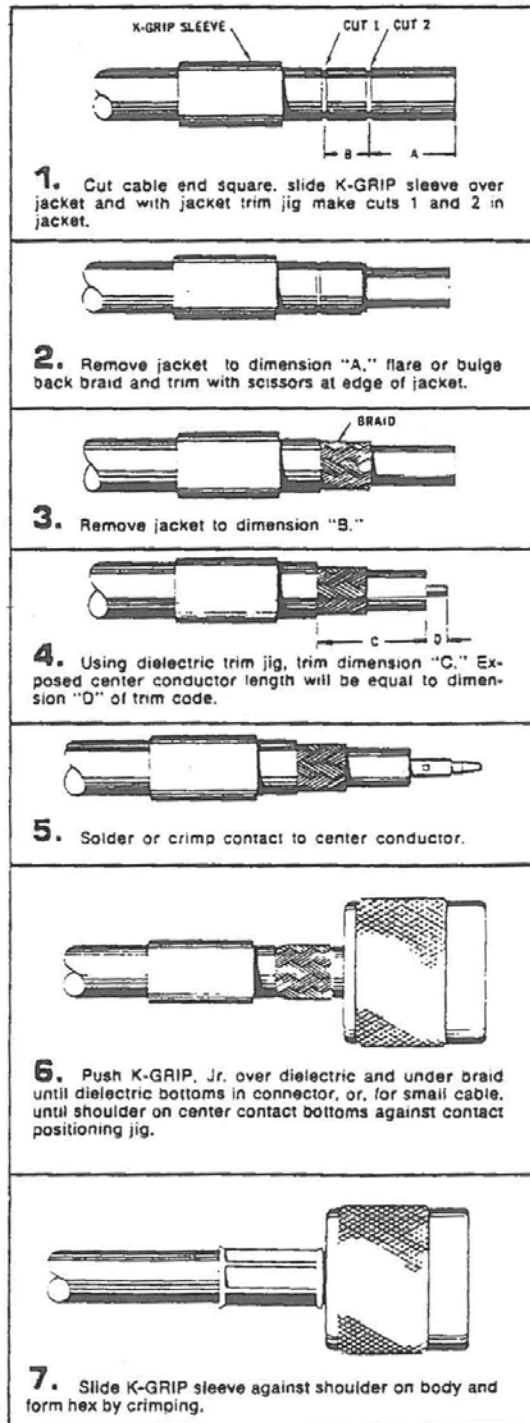

| TRIM CODE CHART | | | | |
|-----------------|------|------|------|------|
| CODE | A | B | C | D |
| 444 | 7/16 | 9/32 | .500 | 7/32 |

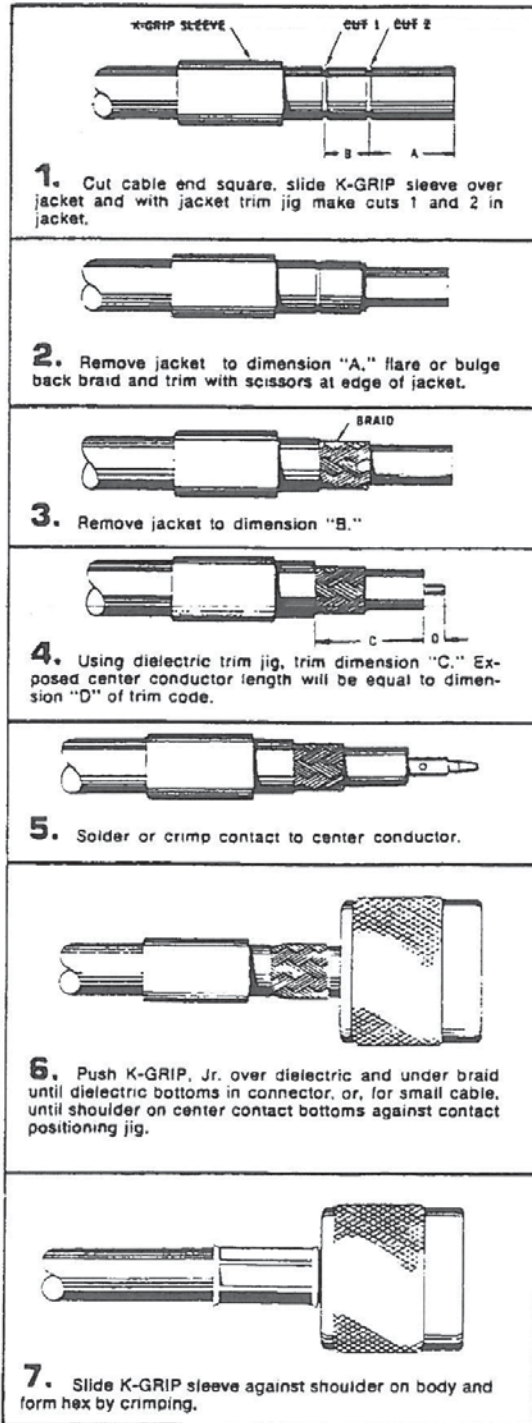

| TRIM CODE CHART | | | | |
|-----------------|-------|------|------|-------|
| CODE | A | B | C | D |
| 460 | 17/32 | 7/32 | .541 | 13/64 |



| TRIM CODE CHART | | | | |
|-----------------|-----|---------|---|---|
| CODE | A | B | C | D |
| 472 | USE | CP-5401 | | |

1. Cut cable end square, slide K-GRIP sleeve over jacket and with jacket trim jig make cuts 1 and 2 in jacket

2. Remove jackets to dimension "A," flare or bulge back braid and trim with scissors at edge of jacket.

3. Remove jacket to dimension "B."

4. Using dielectric trim jig, trim dimension "C." Exposed center conductor length will be equal to dimension "D" of trim code.

5. Solder or crimp contact to center conductor.
5A. For 10 & 20 KV connectors, when Cable Seal Gasket is supplied, place over center conductor and against cable dielectric. Solder contact to center conductor with gasket under compression.

6. Push K-GRIP Jr. over dielectric and under braid until dielectric bottoms in connector. When the "B" dimension in the trim code is 0, the K-GRIP Jr. is pushed under both braid and jacket. Teflon jackets may be slit axially 1/4" in two places to facilitate entry of the K-GRIP. When center contact is undercut captive type, insert cable assembly until insulator detent locks into contact.

7. Slide K-GRIP sleeve against shoulder on body and form hex. For captive contact connectors, solder contact to center conductor and thread assembly into connector.

All Dimensions in Inches

| TRIM CODE CHART | | | | |
|-----------------|-------|-------|------|------|
| CODE | A | B | C | D |
| 465 | 1/4 | 11/32 | .432 | 5/32 |
| 489 | 11/32 | 11/32 | .500 | 3/16 |
| 5401 | 5/16 | 9/32 | .432 | 5/32 |
| 5402 | 3/8 | 5/16 | .500 | 3/16 |
| 5406 | 13/32 | 9/32 | .500 | 3/16 |
| 5450 | .400 | .313 | .525 | .188 |



| TRIM CODE CHART | | | | |
|-----------------|-----|-----|-----|-----|
| CODE | A | B | C | D |
| 5455 | .30 | .28 | .40 | .18 |

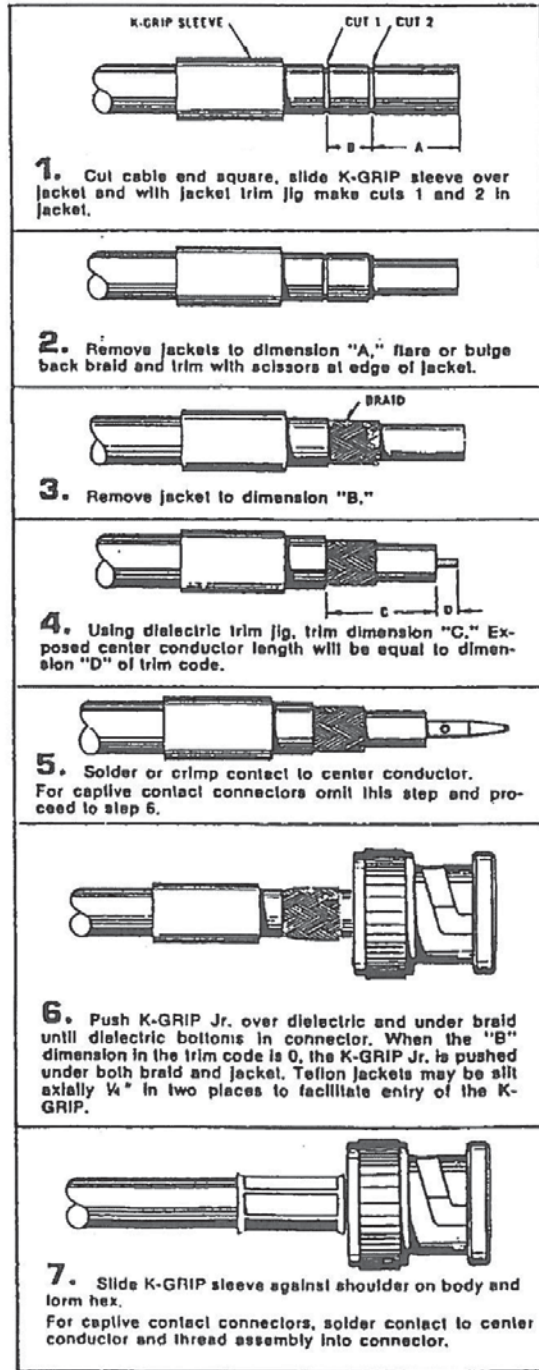

| TRIM CODE CHART | | | | |
|-----------------|-----|-----|-----|-----|
| CODE | A | B | C | D |
| 5458 | .37 | .31 | .56 | .12 |

1. CUT CABLE END SQUARE AND SLIDE CLAMP NUT, SLIP WASHER AND GASKET OVER OUTER CONDUCTOR.
2. TRIM OUTER CONDUCTOR TO "A" DIMENSION WITHOUT CUTTING DIELECTRIC.
3. SLIDE ADAPTER OVER CABLE UNTIL ADAPTER BOTTOMS ON OUTER CONDUCTOR. SOLDER ADAPTER TO OUTER CONDUCTOR USING MINIMUM HEAT.
4. TRIM DIELECTRIC TO DIMENSION "B" AND CENTER CONDUCTOR TO DIMENSION "C".
5. SOLDER CONTACT TO CENTER CONDUCTOR.

| CODE | A | B | C |
|------|------|------|------|
| .708 | .235 | .045 | .120 |

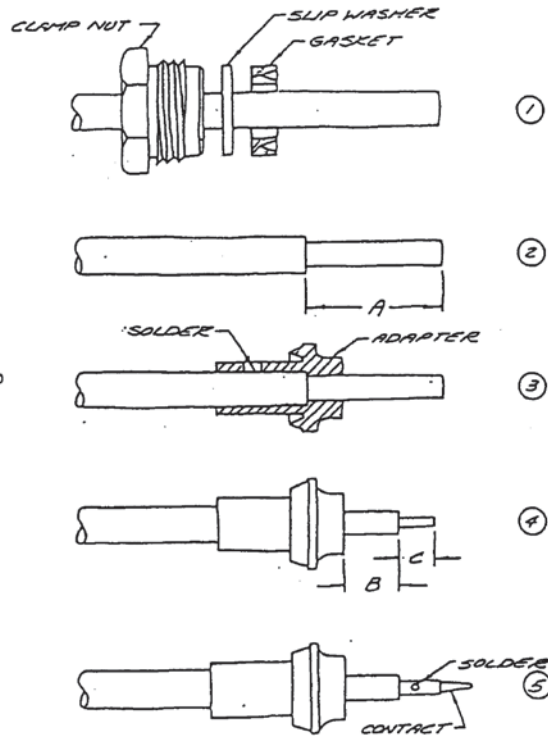

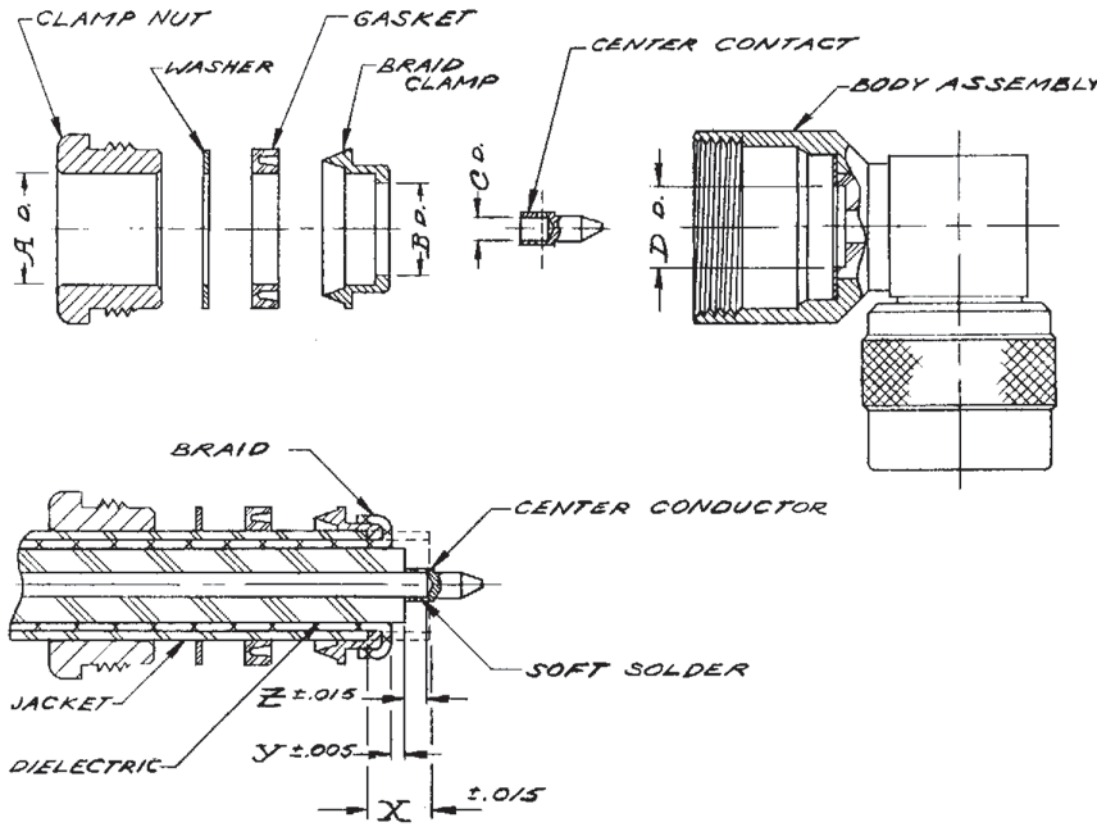



NOTE: CARE MUST BE TAKEN WHEN TRIMMING CABLE THAT THE BRAIDS, INSULATORS AND CONDUCTORS OF THE CABLE ARE NOT NICKED OR DAMAGED.



1. CUT CABLE END SQUARE. PLACE NUT (ITEM 9), COLLET (ITEM 8), THIN WASHER (ITEM 7), AND GASKET (ITEM 6) OVER THE JACKET.



2. REMOVE OUTER JACKET TO 1-1/32" DIMENSION SHOWN.



3. PLACE BRAID CLAMP (ITEM 5) OVER THE OUTER BRAID AND SEAT AGAINST THE OUTER JACKET.



4. FOLD THE OUTER BRAID BACK OVER THE BRAID CLAMP, AND PRESS THE OUTER GROUND RING (ITEM 11) OVER THE BRAID AND BRAID CLAMP SO THAT THE OUTER GROUND RING IS FLUSH TO THE EDGE OF THE BRAID CLAMP. TRIM EXCESS BRAID THAT EXTENDS BEYOND THE OUTER DIAMETER OF THE BRAID CLAMP.



- 5A. REMOVE INNER JACKET AND INNER BRAID TO 5/16" DIMENSION. REMOVE INNER JACKET AN ADDITIONAL 9/32". DO NOT NICK BRAID.
- B. REMOVE INNER DIELECTRIC TO 1/8" DIMENSION TO EXPOSE INNER CONDUCTOR. DO NOT NICK OR UNRAVEL CENTER CONDUCTOR.
- C. PLACE THICK WASHER (ITEM 4) AGAINST RING.



6. PLACE THE MALE OR FEMALE CONNECTOR CONTACT (ITEM 1) OVER THE CENTER CONDUCTOR OF THE CABLE AND BUTT IT AGAINST THE CORE. CRIMP OR SOLDER THE CONTACT TO THE CORE.



PLACE CRIMP SLEEVE (ITEM 3) OVER INNER BRAID OF THE CABLE. SLIDE BODY ASSEMBLY (ITEM 2) OVER THE CORE (INNER DIELECTRIC) AND UNDER THE INNER BRAID UNTIL THE CONTACT BOTTOMS IN THE CONNECTOR. (NOTE: CAUTION MUST BE EXERCISED TO NOT ALLOW ANY OF THE BRAID TO REMAIN INSIDE THE CONNECTOR ASSEMBLY. ALL BRAID MUST BE ON THE OUTSIDE OF THE BODY.) SLIDE THE CRIMP SLEEVE OVER BODY AND BRAID TO WITHIN 1/64" OF THE BODY SHOULDER. CRIMP THE SLEEVE.

SLIDE CONNECTOR INTO MAIN CONNECTOR BODY (ITEM 10). TIGHTEN COLLET TO BODY WITH A MINIMUM OF 80 INCH POUNDS OF TORQUE. IT IS RECOMMENDED NOT TO EXCEED 125 INCH POUNDS OF TORQUE. LOCK CLAMP NUT TO COLLET TO PREVENT ROTATION OF CABLE WITHIN THE CONNECTOR. "U" SPACER, ITEM 12, IS SUPPLIED ONLY WITH SMALL CABLE CONNECTORS. IT IS PLACED OVER ITEM 3 AFTER CRIMPING AND BEFORE THREADING CABLE ASSEMBLY INTO BODY.



NOTE: CARE MUST BE TAKEN WHEN TRIMMING CABLE THAT THE BRAIDS, INSULATORS AND CONDUCTORS OF THE CABLE ARE NOT NICKED OR DAMAGED.



1. CUT CABLE END SQUARE. PLACE NUT (ITEM 1), COLLET (ITEM 2), THIN WASHER (ITEM 3), AND GASKET (ITEM 4) OVER THE JACKET.



2. REMOVE OUTER JACKET TO 1-17/32" DIMENSION SHOWN.



3. COMB OUT BRAID AS SHOWN.

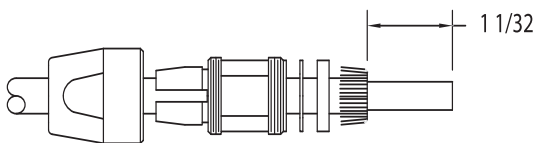

4. FOLD BRAID BACK AND TRIM CABLE BACK 1/2".



5. COMB OUT BRAID AGAIN AND FORM END AS SHOWN.

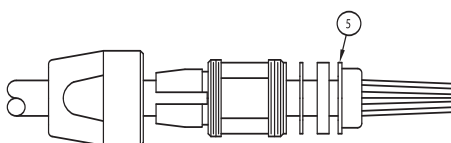

6. PLACE BRAID CLAMP (ITEM 5) OVER THE OUTER BRAID AND SEAT AGAINST THE OUTER JACKET.



7. FOLD THE OUTER BRAID BACK OVER THE BRAID CLAMP, AND PRESS THE OUTER GROUND RING (ITEM 6) OVER THE BRAID AND BRAID CLAMP SO THAT THE OUTER GROUND RING IS FLUSH TO THE EDGE OF THE BRAID CLAMP. TRIM EXCESS BRAID THAT EXTENDS BEYOND THE OUTER DIAMETER OF THE BRAID CLAMP.

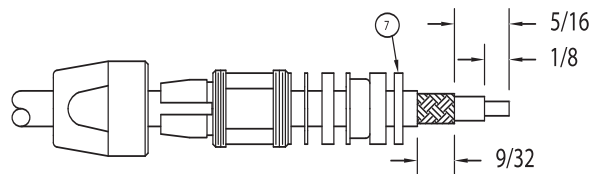

8A. REMOVE INNER JACKET AND INNER BRAID TO 5/16" DIMENSION. REMOVE INNER JACKET AN ADDITIONAL 9/32". DO NOT NICK BRAID.
B. REMOVE INNER DIELECTRIC TO 1/8" DIMENSION TO EXPOSE INNER CONDUCTOR. DO NOT NICK OR UNRAVEL CENTER CONDUCTOR.
C. PLACE THICK WASHER (ITEM 7) AGAINST GROUND RING.



9. PLACE THE MALE OR FEMALE CONNECTOR CONTACT (ITEM 10) OVER THE CENTER CONDUCTOR OF THE CABLE AND BUTT IT AGAINST THE CORE. CRIMP OR SOLDER THE CONTACT TO THE CORE.

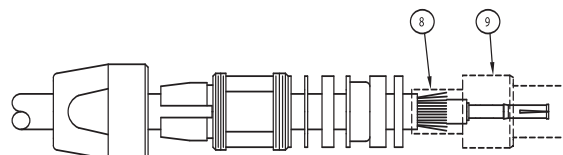

10. PLACE CRIMP SLEEVE (ITEM 8) OVER INNER BRAID OF THE CABLE. SLIDE BODY ASSEMBLY (ITEM 9) OVER THE CORE (INNER DIELECTRIC) AND UNDER THE INNER BRAID UNTIL THE CONTACT BOTTOMS IN THE CONNECTOR. (NOTE: CAUTION MUST BE EXERCISED NOT TO ALLOW ANY OF THE BRAID TO REMAIN INSIDE THE CONNECTOR ASSEMBLY. ALL BRAID MUST BE ON THE OUTSIDE OF THE BODY.) SLIDE THE CRIMP SLEEVE OVER BODY AND BRAID TO WITHIN 1/64" OF THE BODY SHOULD. CRIMP THE SLEEVE.

SLIDE CONNECTOR INTO MAIN CONNECTOR BODY (ITEM 11). TIGHTEN COLLET TO BODY WITH A MINIMUM OF 80 INCH POUNDS OF TORQUE. IT IS RECOMMENDED NOT TO EXCEED 125 INCH POUNDS OF TORQUE. LOCK CLAMP NUT TO COLLET TO PREVENT ROTATION OF CABLE WITHIN THE CONNECTOR.



1. Cut cable and square and slide K-grip sleeve over jacket.
2. Cut through jacket and braid to dimension A, leaving cut jacket and braid in place until step 3 below. This may be conveniently done with a B-T stripper which will cut cleanly through both jacket and braid. When cutting through braid avoid tangling strand ends.
3. Remove jacket to dimension B, without nicking braid. Remove braid cut to dimension A in step 2, above.
4. Flare out braid slightly to permit slotted end of K-grip to enter between dielectric and braid. Flaring tool S-89-24-5 may be used for this operation.
5. Assemble K-grip, gasket and clamp nut on K-grip.
6. Push K-grip over dielectric and under braid as far as it will go.
7. Slide K-grip sleeve forward over braid and K-grip gasket up to small shoulder on K-grip. Place assembly in K-grip forming tool centering sleeve between die halves and form hex.
8. Assemble dielectric trim jig to clamp nut, remove dielectric flush with jig and trim center conductor in usual manner.
9. Solder or crimp center contact to center conductor. Remove dielectric trim jig. Place connector gasket and braid clamp on K-grip. Then insert assembly into connector body and lock securely by clamp nut.

CABLE TRIM CODE

| CODE | A | B | C | D |
|------|------------------|---------------|------|-----------------|
| I | $1\frac{5}{32}$ | $\frac{1}{4}$ | .093 | $\frac{3}{16}$ |
| II | $1\frac{25}{32}$ | $\frac{1}{4}$ | .666 | $\frac{3}{16}$ |
| III | $1\frac{7}{16}$ | $\frac{1}{4}$ | .297 | $\frac{7}{32}$ |
| IV | $1\frac{1}{8}$ | $\frac{1}{4}$ | .093 | $\frac{5}{32}$ |
| V | $1\frac{13}{32}$ | $\frac{1}{4}$ | .333 | $\frac{5}{32}$ |
| VI | $1\frac{3}{32}$ | $\frac{1}{4}$ | .094 | $\frac{1}{8}$ |
| VII | $1\frac{53}{64}$ | $\frac{1}{4}$ | .437 | $\frac{23}{32}$ |

| Cable Design | Armor O.D. Max | Jacket O.D. Max | Braid O.D. Max | Dielectric O.D. Max | Center Conductor Stranding | Conductor O.D. Nom | Nominal Impedance Ohms | Max Freq. GHz | Max Power Watts at 400 MHz | M17/ Replacement | Notes |
|--------------|----------------|-----------------|----------------|---------------------|----------------------------|--------------------|------------------------|---------------|----------------------------|------------------|-------|
| RG5B/U | | 0.335 | .260 D | 0.185 | Solid | 0.051 | 50 | | | 73-RG212 | |
| RG6A/U | | 0.336 | .264 D | 0.189 | Solid | 0.029 | 75 | | | 2-RG6 | |
| RG8A/U | | 0.415 | .340 S | 0.295 | 7/AWG21 | 0.086 | 52 | | | 74-RG213 | |
| RG9B/U | | 0.43 | .355 D | 0.285 | 7/AWG21 | 0.086 | 50 | | | 75-RG214 | |
| RG10A/U | 0.475 | 0.415 | .340 S | 0.295 | 7/AWG21 | 0.086 | 52 | | | 74-RG215 | |
| RG11A/U | | 0.412 | .340 S | 0.292 | 7/AWG26 | 0.048 | 75 | | | 6-RG11 | |
| RG12A/U | 0.475 | 0.412 | .340 S | 0.292 | 7/.0159 | 0.048 | 75 | | | 6-RG12 | |
| RG13A/U | | 0.43 | .355 D | 0.29 | 7/AWG26 | 0.048 | 74 | | | 77-RG216 | |
| RG14A/U | | 0.558 | .463 D | 0.383 | Solid | 0.102 | 52 | | | 78-RG217 | |
| RG17/U | | 0.885 | .760 S | 0.695 | Solid | 0.188 | 52 | | | 79-RG218 | |
| RG17A/U | | 0.885 | .760 S | 0.695 | Solid | 0.188 | 52 | | | 79-RG218 | |
| RG18/U | 0.945 | 0.885 | .760 S | 0.695 | Solid | 0.188 | 52 | | | 79-RG219 | |
| RG18A/U | 0.945 | 0.885 | .760 S | 0.695 | Solid | 0.188 | 52 | | | 79-RG219 | |
| RG19/U | | 1.135 | .760 S | 0.695 | Solid | 0.188 | 52 | | | 81-00001 | |
| RG19A/U | | 1.135 | .990 S | 0.925 | Solid | 0.25 | 52 | | | 81-00001 | |
| RG20/U | 1.195 | 1.135 | .990 S | 0.925 | Solid | 0.25 | 52 | | | 81-00002 | |
| RG20A/U | 1.195 | 1.135 | .990 S | 0.925 | Solid | 0.25 | 52 | | | 81-00002 | |
| RG21/U | | 0.339 | .264 D | 0.192 | Solid | 0.051 | 53 | | | 162-00001 | |
| RG21A/U | | 0.339 | .264 D | 0.192 | Solid | 0.051 | 53 | | | 162-00001 | |
| RG22B/U | | 0.43 | .355 D | 0.291 | 7/.0152 | 0.046 | 95 | 200 MHz | | 15-RG22 | Twin |
| RG55A/U | | 0.216 | .171 D | 0.116 | Solid | 0.035 | 50 | | | 84-RG223 | |
| RG55B/U | | 0.206 | .176 D | 0.121 | Solid | 0.032 | 53.5 | | | 84-RG223 | |
| RG58/U | | 0.199 | | 0.12 | Solid | 0.032 | 53.5 | | | 28-RG58 | |
| RG58A/U | | 0.199 | | 0.12 | 19/AWG33 | 0.038 | 52 | | | 28-RG58 | |
| RG58B/U | | 0.199 | | 0.12 | Solid | 0.032 | 53.5 | | | 28-RG58 | |
| RG58C/U | | 0.199 | .150 S | 0.12 | 19/AWG33 | 0.038 | 50 | | | 28-RG58 | |
| RG59/U | | 0.242 | .191 S | 0.15 | Solid | | 73 | | | 29-RG59 | |
| RG59A/U | | 0.242 | .191 S | 0.15 | Solid | 0.023 | 73 | | | 29-RG59 | |
| RG59B/U | | 0.246 | .191 S | 0.15 | Solid | 0.023 | 75 | | | 29-RG59 | |
| RG62/U | | 0.249 | .191 S | 0.151 | Solid | 0.025 | 93 | | | 30-RG62 | |
| RG62A/U | | 0.249 | .191 S | 0.151 | Solid | 0.025 | 93 | | | 30-RG62 | |
| RG62B/U | | 0.249 | .191 S | 0.151 | 7/AWG32 | 0.025 | 93 | | | 30-RG62 | |
| RG63B/U | | 0.415 | .340 S | 0.295 | Solid | 0.025 | 125 | | | 31-RG63 | |
| RG71B/U | | 0.25 | .208 D | 0.151 | Solid | 0.025 | 93 | | | 90-RG71 | |
| RG82/U | | 0.757 | | 0.675 | Solid | 0.125 | 50 | | | | |
| RG108A/U | | 0.245 | .177 S (Nom) | 0.082 | 7/AWG28 | | 78 | | | 45-RG108 | Twin |
| RG114/U | | 0.415 | .340 S | 0.295 | Solid | 0.007 | 185 | | | 47-RG114 | |
| RG114A/U | | 0.415 | .340 S | 0.295 | Solid | 0.007 | 185 | | | 47-RG114 | |
| RG115/U | | 0.385 | .320 D | 0.255 | 7/.028 | | 50 | | | 168-00001 | |
| RG115A/U | | 0.43 | .325 D | 0.26 | 7/AWG21 | 0.086 | 50 | | | 168-00001 | |
| RG117/U | | 0.745 | .670 S | 0.625 | Solid | 0.188 | 50 | | | 72-RG211 | |

CABLE REFERENCE TABLE

| Cable Design | Armor O.D. Max | Jacket O.D. Max | Braid O.D. Max | Dielectric O.D. Max | Center Conductor Stranding | Center Conductor O.D. Nom | Nominal Impedance Ohms | Max Freq. GHz | Max Power Watts at 400 MHz | M17/ Replacement | Notes |
|--------------|----------------|-----------------|----------------|---------------------|----------------------------|---------------------------|------------------------|---------------|----------------------------|------------------|--------------------|
| RG117A/U | | 0.745 | .670 S | 0.625 | Solid | 0.188 | 50 | | | 72-RG211 | |
| RG118/U | 0.795 | 0.745 | .670 S | 0.625 | Solid | 0.188 | 50 | | | 161-00002 | |
| RG118A/U | 0.795 | 0.745 | .670 S | 0.625 | Solid | 0.188 | 50 | | | 161-00002 | |
| RG122/U | | 0.165 | .126 S | 0.099 | 27/AWG36 | 0.03 | 50 | | | 54-RG122 | |
| RG141/U | | 0.195 | 0.146 | 0.121 | Solid | 0.036 | 50 | | | 111-RG303 | |
| RG141A/U | | 0.195 | .146 S | 0.121 | Solid | 0.039 | 50 | | | 111-RG303 | |
| RG142A/U | | 0.206 | .171 D | 0.121 | Solid | 0.039 | 50 | | | 60-RG142 | |
| RG142B/U | | 0.2 | .171 D | 0.121 | Solid | 0.039 | 50 | | | 60-RG142 | |
| RG143/U | | 0.332 | 0.25 | 0.19 | Solid | 0.057 | 50 | | | 112-RG304 | |
| RG143A/U | | 0.332 | .250 D | 0.19 | Solid | 0.059 | 50 | | | 112-RG304 | |
| RG174/U | | 0.105 | .088 S | 0.063 | 7/AWG34 | 0.02 | 50 | | | 119-RG174 | |
| RG174A/U | | 0.105 | .088 S | 0.063 | 7/AWG34 | 0.02 | 50 | | | 119-RG174 | |
| RG178B/U | | 0.075 | .054 S | 0.036 | 7/AWG38 | 0.012 | 50 | | | 93-RG178 | |
| RG179B/U | | 0.105 | .084 S | 0.066 | 7/AWG38 | 0.012 | 75 | | | 94-RG179 | |
| RG180B/U | | 0.145 | .124 S | 0.105 | 7/AWG38 | 0.012 | 95 | | | 95-RG180 | |
| RG187A/U | | 0.11 | .084 S | 0.066 | 7/AWG38 | 0.012 | 75 | | | 136-00001 | |
| RG188A/U | | 0.11 | .081 S | 0.063 | 7/.0067 | 0.02 | 50 | | | 138-00001 | |
| RG189/U | | 0.875 | | 0.632 | Solid | 0.251 | 50 | | | | Helix, (Nom Dims.) |
| RG195/U | | 0.155 | .124 S | 0.105 | 7/.004 | 0.012 | 95 | | | 137-00001 | |
| RG195A/U | | 0.155 | .124 S | 0.105 | 7/AWG38 | 0.012 | 95 | | | 137-00001 | |
| RG196/U | | 0.08 | .054 S | 0.036 | 7/.004 | 0.012 | 50 | | | 93-00001 | |
| RG196A/U | | 0.08 | .054 S | 0.036 | 7/AWG38 | 0.012 | 50 | | | | |
| RG210/U | | 0.25 | .191 S | 0.151 | Solid | 0.025 | 93 | | | 97-RG210 | |
| RG211A/U | | 0.745 | .670 S | 0.625 | Solid | 0.19 | 50 | | | 72-RG211 | |
| RG212/U | | 0.336 | .265 D | 0.189 | Solid | 0.056 | 50 | | | 73-RG212 | |
| RG213/U | | 0.412 | .340 S | 0.292 | 7/.0296 | 0.089 | 50 | | | 74-RG213 | |
| RG214/U | | 0.432 | .360 D | 0.292 | 7/.0296 | 0.089 | 50 | | | 75-RG214 | |
| RG215/U | 0.475 | 0.412 | .340 S | 0.292 | 7/.0296 | 0.089 | 50 | | | 74-RG215 | |
| RG216/U | | 0.432 | .360 D | 0.292 | 7/AWG26 | 0.048 | 75 | | | 77-RG216 | |
| RG217/U | | 0.555 | .463 D | 0.38 | Solid | 0.106 | 50 | | | 78-RG217 | |
| RG218/U | | 0.88 | .760 S | 0.69 | Solid | 0.195 | 50 | | | 79-RG218 | |
| RG219/U | 0.945 | 0.88 | .760 S | 0.69 | Solid | 0.195 | 50 | | | 79-RG219 | |
| RG220/U | | 1.135 | .990 S | 0.925 | Solid | 0.26 | 50 | | | 81-00001 | |
| RG221/U | 1.195 | 1.135 | .990 S | 0.925 | Solid | 0.26 | 50 | | | 81-00002 | |
| RG222/U | | 0.336 | .264 D | 0.189 | Solid | 0.056 | 50 | | | 162-00001 | |
| RG223/U | | 0.216 | .176 D | 0.12 | Solid | 0.035 | 50 | | | 84-RG223 | |
| RG224/U | 0.615 | 0.555 | .463 D | 0.38 | Solid | 0.106 | 50 | | | 165-00002 | |
| RG225/U | | 0.44 | .360 D | 0.29 | 7/.031 | 0.094 | 50 | | | 127-RG393 | |
| RG228/U | 0.795 | 0.745 | .670 S | 0.625 | Solid | 0.19 | 50 | | | 161-00002 | |
| RG228A/U | 0.795 | 0.745 | .670 S | 0.625 | Solid | 0.19 | 50 | | | 161-00002 | |
| RG301/U | | 0.25 | .215 S | 0.19 | 7/.0203 | 0.0609 | 50 | | | 109-RG301 | |

| Cable Design | Armor O.D. Max | Jacket O.D. Max | Braid O.D. Max | Dielectric O.D. Max | Center Conductor Stranding | Center Conductor O.D. Nom | Nominal Impedance Ohms | Max Freq. GHz | Max Power Watts at 400 MHz | M17/ Replace ment | Notes |
|--------------|----------------|-----------------|----------------|---------------------|----------------------------|---------------------------|------------------------|---------------|----------------------------|-------------------|---------------------|
| RG302/U | | 0.206 | .176 S | 0.151 | Solid | 0.025 | 75 | | | 109-RG302 | |
| RG303/U | | 0.175 | .146 S | 0.121 | Solid | 0.039 | 50 | | | 111-RG303 | |
| RG304/U | | 0.285 | .250 D | 0.19 | Solid | 0.059 | 50 | | | 112-RG304 | |
| RG316/U | | 0.102 | .081 S | 0.063 | 7/.0067 | 0.02 | 50 | | | 113-RG316 | |
| RG389/U | | 0.875 | | 0.635 | Solid | 0.25 | 50 | | | | Spline, (Nom Dims.) |
| RG393/U | | 0.4 | .360 D | 0.29 | 7/.0312 | 0.094 | 50 | | | 127-RG393 | |
| RG400/U | | 0.2 | .171 D | 0.121 | 19/AWG33 | 0.039 | 50 | | | 128-RG400 | |
| RG401/U | | 0.251 | | 0.211 | Solid | 0.0641 | 50 | | | 129-RG401 | Semi-Rigid |
| RG402/U | | 0.141 | | 0.118 | Solid | 0.036 | 50 | | | 130-RG402 | Semi-Rigid |
| RG403/U | | 0.128 | .098 D | 0.036 | 7/AWG38 | 0.012 | 50 | | | 131-RG403 | |
| RG404/U | | 0.075 | .056 S | 0.036 | 7/AWG38 | 0.012 | 50 | | | 132-RG404 | |
| RG405/U | | 0.086 | | 0.066 | Solid | 0.02 | 50 | | | 133-RG405 | Semi-Rigid |
| M17/2-RG6 | | 0.336 | .264 D | 0.189 | Solid | 0.0285 | 75 | 3 | 210 | | |
| M17/6-RG11 | | 0.412 | .340 S | 0.292 | 7/.0159 | 0.0477 | 75 | 1 | 290 | | |
| M17/6-RG12 | 0.475 | 0.412 | .340 S | 0.292 | 7/.0159 | 0.0477 | 75 | 1 | 290 | | |
| M17/15-RG22 | | 0.43 | .355 D | 0.291 | 7/.0159 | 0.046 | 95 | 200 MHz | | | Twin |
| M17/28-RG58 | | 0.199 | .105 S | 0.12 | 19/.0072 | 0.0355 | 50 | 1 | 90 | | |
| M17/29-RG59 | | 0.246 | .191 S | 0.15 | Solid | 0.0226 | 75 | 1 | 130 | | |
| M17/30-RG62 | | 0.249 | .191 S | 0.15 | Solid | 0.0253 | 93 | 1 | 9 | | |
| M17/31-RG63 | | 0.415 | .340 S | 0.295 | Solid | 0.0253 | 125 | 1 | 330 | | |
| M17/45-RG108 | | 0.245 | .177 S (Nom) | 0.081 | 7/.0126 | 0.0378 | 78 | 10 MHz | | | Twin |
| M17/47-RG114 | | 0.415 | .340 S | 0.295 | Solid | 0.007 | 185 | 1 | 150 | | |
| M17/54-RG122 | | 0.165 | .126 S | 0.099 | 27/.005 | 0.0308 | 50 | 1 | 62 | | |
| M17/60-RG142 | | 0.2 | .171 D | 0.121 | Solid | 0.037 | 50 | 12.4 | 1000 | | |
| M17/72-RG211 | | 0.745 | .670 S | 0.625 | Solid | 0.192 | 50 | 1 | 11000 | | |
| M17/73-RG212 | 0.475 | 0.336 | .265 D | 0.189 | Solid | 0.0556 | 50 | 11 | 350 | | |
| M17/74-RG213 | | 0.412 | .340 S | 0.292 | 7/.0296 | 0.0888 | 50 | 1 | 320 | | |
| M17/74-RG215 | 0.475 | 0.412 | .340 D | 0.292 | 7/.0296 | 0.0888 | 50 | 1 | 320 | | |
| M17/75-RG214 | | 0.432 | .360 D | 0.292 | 7/.0296 | 0.0888 | 50 | 11 | 330 | | |
| M17/77-RG216 | | 0.432 | .360 D | 0.292 | 7/.0159 | 0.0477 | 75 | 3 | 270 | | |
| M17/78-RG217 | | 0.545 | .463 D | 0.38 | Solid | 0.106 | 50 | 3 | 470 | | |
| M17/79-RG218 | | 0.88 | .760 S | 0.69 | Solid | 0.195 | 50 | 1 | 1200 | | |
| M17/79-RG219 | 0.945 | 0.88 | .760 S | 0.69 | Solid | 0.195 | 50 | 1 | 1200 | | |
| M17/81-00001 | | 1.135 | .990 S | 0.925 | Solid | 0.26 | 50 | | | | |
| M17/81-00002 | 1.195 | 1.135 | .990 S | 0.925 | Solid | 0.26 | 50 | | | | |
| M17/84-RG223 | | 0.216 | .176 D | 0.12 | Solid | 0.035 | 50 | 12.4 | 86 | | |
| M17/90-RG71 | | 0.25 | .208 D | 0.151 | Solid | 0.0253 | 93 | | | | |
| M17/93-RG178 | | 0.075 | .054 S | 0.035 | 7/.004 | 0.012 | 50 | 3 | 110 | | |
| M17/93-00001 | | 0.075 | .054 S | 0.035 | 7/.004 | 0.012 | 50 | 3 | 110 | | |
| M17/94-RG179 | | 0.105 | .084 S | 0.066 | 7/.004 | 0.012 | 75 | 3 | 450 | | |
| M17/95-RG180 | | 0.145 | .124 S | 0.105 | 7/.004 | 0.012 | 95 | 3 | 550 | | |

CABLE REFERENCE TABLE

| Cable Design | Armor O.D. Max | Jacket O.D. Max | Braid O.D. Max | Dielectric O.D. Max | Center Conductor Stranding | Center Conductor O.D. Nom | Nominal Impedance Ohms | Max Freq. GHz | Max Power Watts at 400 MHz | M17/ Replacement | Notes |
|---------------|----------------|-----------------|----------------|---------------------|----------------------------|---------------------------|------------------------|---------------|----------------------------|------------------|------------|
| M17/97-RG210 | | 0.25 | .191 S | 0.151 | Solid | 0.0253 | 93 | 3 | 1050 | | |
| M17/110-RG302 | | 0.207 | .176 S | 0.15 | Solid | 0.0253 | 75 | 3 | 1600 | | |
| M17/111-RG303 | | 0.175 | .146 S | 0.121 | Solid | 0.037 | 50 | 3 | 1100 | | |
| M17/112-RG304 | | 0.288 | .250 D | 0.19 | Solid | 0.059 | 50 | 12 | 1450 | | |
| M17/113-RG316 | | 0.012 | 0.0815 | 0.063 | 7/.0067 | 0.0201 | 50 | 3 | 210 | | |
| M17/116-RG307 | | 0.27 | 0.237 | 0.149 | 19/.0058 | 0.029 | 75 | 1 | 130 | | |
| M17/119-RG174 | | 0.115 | 0.0885 | 0.063 | 7/.0063 | 0.0189 | 50 | 1 | 26 | | |
| M17/127-RG393 | | 0.4 | .360 D | 0.29 | 7/.0312 | 0.094 | 50 | 11 | 800 | | |
| M17/128-RG400 | | 0.2 | .171 D | 0.121 | 19/.008 | 0.0384 | 50 | 12.4 | 1050 | | |
| M17/129-RG401 | | 0.251 | | 0.211 | Solid | 0.0641 | 50 | 18 | 1900 | | Semi-Rigid |
| M17/129-00001 | | 0.251 | | 0.211 | Solid | 0.0641 | 50 | 18 | 1900 | | Semi-Rigid |
| M17/130-RG402 | | 0.142 | | 0.1185 | Solid | 0.0362 | 50 | 20 | 660 | | Semi-Rigid |
| M17/130-00001 | | 0.143 | | 0.1185 | Solid | 0.0362 | 50 | 20 | 660 | | Semi-Rigid |
| M17/130-00002 | | 0.142 | | 0.1185 | Solid | 0.0362 | 50 | 20 | 660 | | Semi-Rigid |
| M17/131-RG403 | | 0.128 | .098 D | 0.035 | 7/AWG38 | 0.012 | 50 | 10 | 95 | | |
| M17/132-RG404 | | 0.077 | .056 S | 0.038 | 7/AWG38 | 0.012 | 50 | 1 | | | |
| M17/133-RG405 | | 0.0875 | | 0.068 | Solid | 0.0201 | 50 | 20 | 210 | | Semi-Rigid |
| M17/133-00001 | | 0.0885 | | 0.068 | Solid | 0.0201 | 50 | 20 | 210 | | Semi-Rigid |
| M17/133-00002 | | 0.0875 | | 0.068 | Solid | 0.0201 | 50 | 20 | 210 | | Semi-Rigid |
| M17/134-00001 | | 0.25 | 0.203 | 0.12 | Solid | 0.033 | 50 | 3 | 60 | | Triax |
| M17/134-00002 | | 0.25 | 0.203 | 0.12 | Solid | 0.033 | 50 | 3 | 60 | | Triax |
| M17/136-00001 | | 0.105 | .084 S | 0.066 | 7/.004 | 0.012 | 75 | 3 | 1400 | | |
| M17/137-00001 | | 0.145 | .124 S | 0.105 | 7/.004 | 0.012 | 95 | 3 | 600 | | |
| M17/138-00001 | | 0.102 | .081 S | 0.063 | 7/.0067 | 0.0201 | 50 | 3 | 220 | | |
| M17/161-00001 | | 0.745 | .670 S | 0.625 | Solid | 0.192 | 50 | 400 MHz | | | |
| M17/161-00002 | 0.795 | 0.745 | .670 S | 0.625 | Solid | 0.192 | 50 | 400 MHz | | | |
| M17/162-00001 | | 0.336 | .265 D | 0.189 | Solid | 0.0556 | 50 | 400 MHz | | | |
| M17/165-00001 | | 0.555 | .463 D | 0.38 | Solid | 0.106 | 50 | 400 MHz | | | |
| M17/165-00002 | 0.615 | 0.555 | .463 D | 0.38 | Solid | 0.106 | 50 | 400 MHz | | | |
| M17/168-00001 | | 0.43 | .325 D | 0.26 | 7/.028 | 0.084 | 50 | 400 MHz | | | |
| M17/168-00002 | | 0.354 | .325 D | 0.26 | 7/.028 | 0.084 | 50 | 400 MHz | | | |
| M17/176-00002 | | 0.134 | .102 S | 0.044 | 19/AWG36 | 0.024 | 77 | 10 MHz | | | Twin |
| M17/177-00001 | | 0.189 | 0.162 | 0.105 | 7/.004 | 0.012 | 95 | 3 | 660 | | Triax |
| M17/178-00001 | | 0.27 | 0.225 | 0.105 | 7/.004 | 0.012 | 95 | 3 | 550 | | Triax |
| M17/179-00001 | | 0.195 | 0.17 | 0.066 | 7/.004 | 0.012 | 75 | 3 | 450 | | |

| Cable Group | Cable Type | Cable PN |
|-------------|---|---|
| A | Military Approved | M17/93-00001 RG-178 RG-178A RG-178B RG-196 RG-196A |
| B1 | Military Approved | M17/138-00001 RG-174 RG-188 RG-188A RG-316 |
| B2 | Military Approved | M17/136-00001 RG-179 RG-179A RG-179B RG-187 RG-187A |
| C1 | Military Approved | RG-122 |
| C2 | Military Approved | M17/137-00001 RG-180 RG-180A RG-180B RG-195 RG-195A |
| C3 | Belden Essex | 8218 21-597 |
| D | Military Approved Military Approved Military Approved Military Approved Military Approved Belden Belden Belden | RG-141 RG-141A RG-303 RG-58* RG-58A* RG-58C* 8259 8262 9201 |
| E1 | Military Approved | RG-142 RG-142A RG-223 RG-400 RG-55A |
| E2 | Military Approved | RG-142B RG-55* RG-55B* |
| G1 | Military Approved | RG-210 RG-59 RG-59A RG-59B RG-62 RG-62A RG-62B RG-62C" |
| G2 | Military Approved | RG-71 RG-71A RG-71B |
| H | Military Approved | RG-302 |
| K1 | Military Approved | M17/162-00001 RG-21 RG-212 RG-21A RG-5 RG-5A RG-5B |
| K2 | Military Approved | RG-6 RG-6A |

| Cable Group | Cable Type | Cable PN |
|-------------|--|--|
| K3 | Military Approved | M17/162-00001 RG-143 RG-143A RG-212 RG-222 RG-304 |
| L | Military Approved | M17/168-00001 RG-115A |
| M1 | Military Approved | RG-213 RG-8 RG-8A |
| M2 | Military Approved | RG-11 RG-11A |
| N1 | Military Approved | RG-214 RG-9 RG-9A RG-9B |
| N2 | Military Approved | RG-13A RG-216 |
| N3 | Military Approved | RG-225 RG-393 |
| P | Military Approved | RG-108 RG-393 |
| Q | Belden WE | 8281 24 |
| R | Military Approved | M17/165-00002 RG-14 RG-14A RG-217RG-224** |
| T | Military Approved | RG-17A RG-218 RG-219** |
| U | Military Approved | RG-10** RG-12** RG-215** |
| V | Times Military Approved Military Approved | TRF-58 M17/134-00001 M17/134-00003 |
| W | Military Approved | M17/176-00002 |
| X | Military Approved | RG-405 |
| Y | Military Approved | RG-401 |
| Z | Raytheon Military Approved | 11464213 RG-307 |
| I | Times Military Approved Military Approved Military Approved | AA6343 RG-142 RG-223 RG-400 |
| 2 | ITT Military Approved | BA6903 RG-214 |
| 3 | Military Approved | M17/152-00001 RD-316 |
| 4 | Military Approved | RG-393 |
| 5 | Times | AA 2831 FEP 226 |
| 6 | Times | AA 5885 |
| 7 | Times | AA 5886 |
| 8 | Times | AA 5887 |
| 9 | Times | AA 5888 |

| Cable Group | Cable Type | Cable PN |
|-------------|--|---|
| 10 | Times | AA 5889 |
| 11 | McDonnell Douglas | BXS 7004-502-06090 |
| 12 | ECS Raychem ITT | 311201 5012H3012 BA 20048 |
| 13 | Teledyne Thermatics | 13784 |
| 14 | Teledyne Thermatics | 13850 |
| 15 | Boeing Boeing Adams Russell | BMS 13-65 Type 0E S280W503-1 FC11Z |
| 16 | Boeing Boeing Adams Russell | BMS 13-65 Type 0F S280W503-2 FC14Z |
| 17 | Boeing Boeing Adams Russell | BMS 13-65 Type 0G S280W503-3 FC20Z |
| 18 | Boeing Boeing Adams Russell | BMS 13-65 Type 0H S280W503-4 FC28Z |
| 19 | Boeing Boeing Adams Russell | BMS 13-65 Type 0J S280W503-5 FC38Z |
| 20 | Boeing Boeing Adams Russell | BMS 13-65 Type 0K S280W503-6 FC48Z |
| 21 | Boeing Adams Russell | HS5965-2 FC09Z |
| 22 | Andrew Andrew Andrew | FHJ2-50A FSJ4-50B FSJ4RN-50B |
| 23A | Belden Belden | 1279P 1279R |
| 23B | Belden | 179DT |
| 24 | Belden Belden GepCo | 1505A 9259 VPM2000 |
| 25 | Belden GepCo | 1694A VSD2001 |
| 26 | Belden GepCo | 1855A VDM230 |
| 27 | Belden Belden Belden Belden Belden | 8279 8279A 9209 9209A 9244 |
| 28 | Military Approved | M17/179-20001 |
| 29 | Military Approved | D3-7619-5/338 |
| 30 | Telecommunications | 734 |
| 31 | Telecommunications | 735 |
| 40 | LASL Type | C-9Y19503 |
| 41 | Belden | YR49220 |
| 42 | Dielectric Science | 2075 |
| 43 | Gore Gore Raychem Raychem Raychem | GSC-12-2548 GSC-12-2549 10-613 10-614 2524E0114 |

| Cable Group | Cable Type | Cable PN |
|-------------|--|---|
| 44 | Raychem | 5026N5611 |
| 45 | ITT ITT Times | BA 13077A BA 14349 MI 5406 |
| 46 | Essex | 21-204 |
| 47 | Raychem ITT | 752405011 BA 6416A |
| 48 | Semi Rigid | 0.86 |
| 49 | Semi Rigid | 0.141 RG-402" |
| 50 | Semi Rigid | 0.085 RG-405 |
| 51 | Semi Rigid | 0.047" |
| 52 | Dielectric Science | RD 178 |
| 70 | Belden West Penn/CDT West Penn/CDT GepCo GepCo | 8233 3811 1150 VT6181IPE VT6181I |
| 73 | Belden Belden Belden GepCo GepCo | 1856A 1857A 9267 LVT61859 VT61859 |
| 74 | Belden GepCo | 9232 LVT6181I |
| 76 | Belden Belden West Penn/CDT | 8232 8232A 3815 |
| 78 | Belden | 88232 |
| 79 | Belden West Penn/CDT GepCo | 1859A 253811 VT6181ITK |
| 80 | Belden | 7784AS |
| 81 | Belden Belden Belden Belden Belden Belden Belden GepCo Times | 7731A 7732A 8213 8231 8238 8261 9011 9292 VHD1100 LMR 400-75 |
| 82 | Times | LMR 100 |
| 83 | Times | LMR 195 |
| 84 | Times | LMR 200 |
| 85 | Times | LMR 300 |
| 86 | Times | LMR 400 |
| 87 | Times | LMR 500 |
| 88 | Times | LMR 600 |
| 89 | Times | LMR 240 |
| 90 | Times | |

AMPLIFIER

A device used to increase the operating level of an input signal. Used in a cable system's distribution plant to compensate for the effects of attenuation caused by coaxial cable and passive device losses.

ANSI

American National Standards Institute

ATTENUATION

The difference between transmitted and received power due to loss from lines, electronic components, or other transmission devices; usually expressed in decibels (dB).

BODY

Main or largest portion of a connector to which other components are attached.

BRAID

Weave of metal fibers used as a shield covering for an insulated conductor or a group of insulated conductors.

BULKHEAD

Term used to define a mounting style of connectors. Bulkhead connectors are designed to be inserted into a panel cutout from the front or the rear of the panel, and typically secured with a jam nut.

COAXIAL CABLE

Cable composed of an insulated central conducting wire, wrapped in another cylindrical conducting wire or braid. Coax cable has great capacity to carry high speed data typically used in Cable TV, connecting computers and central office switching.

CONTACT

Electrically conductive component designed for use in a multi-circuit connector.

CONTACT ENGAGING and SEPARATING FORCE

Force required to either engage or separate contacts.

CONTACT RESISTANCE

Measurement of electrical resistance of mated contacts when assembled in a connector under typical service use.

DECIBEL (dB)

A unit of measurement which expresses the ratio of two power levels on a logarithmic scale. It is used in cable systems to specify losses, k gains, and other ratios of power. The decibel is one-tenth of a Bel.

FCC

Federal Communications Commission

IMPEDANCE

Resistance to the flow of AC current. In telecommunications and broadcast systems, the characteristic impedance is 75 ohms. If all cable and devices are equal to the characteristic impedance, maximum signal will be transferred with little or no reflection.

IMPEDANCE MISMATCH

A situation that results when two components are connected, each having a different characteristic impedance. This generally results in adverse attenuation and return loss.

INSERTION LOSS

That property between the input and output of a device causing a predictable signal loss.

INTERMODULATION

Beats and harmonics creating interference due to the mixing of more than one carrier in an amplifying device. Usually to non-linear.

ISO

International Standards Organization

MATCHED IMPEDANCE

Coupling of two components or systems in such a way that the impedance of one system equals the impedance of the other system.

NEBS

National Equipment Building Systems

OHM's LAW

The relationship between voltage, current, and resistance in an electronic circuit. The third quantity can be found if two are known.

PASSIVE DEVICE

A device used in a cable system not requiring electrical power to operate. It normally represents loss to signals passing through it. Examples of passive devices are splitters, directional couplers, pads, and equalizers.

RETURN LOSS

The value (in decibels) of the ratio of the power or voltage loss between the forward (transmitted) wave and the reflected wave, as a result of impedance mismatch.

RETURN PATH

The band of frequencies used to return signals to the cable head-end either as control data or for redistribution on the forward path.

RF

Abbreviation for "radio frequency". Typically between 300KHz through 3GHz.

RG/U

(R—radio frequency, G—government approval number, U—universal specification). Symbol for Government specified coaxial cable.

VSWR

Abbreviation for Voltage Standing Wave Ratio, a measure of return loss of a transmission circuit.

MILITARY CROSS REFERENCE

| Military PN | KINGS® PN | Product Family | Page Number | Military PN | KINGS® PN | Product Family | Page Number |
|-----------------|-----------|-------------------|-------------|----------------|-----------|-------------------|-------------|
| M39012/01-0005 | KN-59-176 | N Series | 36 | M39012/16-0015 | 755-115-5 | 50 Ohm BNC Series | 7 |
| M39012/01-0015 | 1205-37-5 | N Series | 36 | M39012/16-0016 | 755-116-5 | 50 Ohm BNC Series | 7 |
| M39012/01-0017 | 1205-68-5 | N Series | 38 | M39012/16-0017 | 755-117-5 | 50 Ohm BNC Series | 7 |
| M39012/01-0018 | 1205-69-5 | N Series | 38 | M39012/16-0020 | 755-118-5 | 50 Ohm BNC Series | 7 |
| M39012/01-0101 | KN-59-294 | N Series | 36 | M39012/16-0101 | KC-59-544 | 50 Ohm BNC Series | 6 |
| M39012/01-0104 | KN-59-295 | N Series | 36 | M39012/16-0101 | 755-74-5 | 50 Ohm BNC Series | 6 |
| M39012/01-0125 | KN-59-296 | N Series | 36 | M39012/16-0102 | KC-59-545 | 50 Ohm BNC Series | 6 |
| M39012/01-0501 | KN-59-239 | N Series | 38 | M39012/16-0118 | KC-59-548 | 50 Ohm BNC Series | 6 |
| M39012/01-0502 | KN-59-202 | N Series | 38 | M39012/16-0220 | 755-86-5 | 50 Ohm BNC Series | 6 |
| M39012/01-0503 | KN-59-242 | N Series | 38 | M39012/16-0501 | 755-119-5 | 50 Ohm BNC Series | 7 |
| M39012/01-0504 | 1205-19-5 | N Series | 38 | M39012/16-0502 | 755-120-5 | 50 Ohm BNC Series | 7 |
| M39012/02-0003 | KN-39-68 | N Series | 33 | M39012/16-0503 | 755-121-5 | 50 Ohm BNC Series | 7 |
| M39012/02-0006 | 1201-9-5 | N Series | 34 | M39012/16-0504 | 755-122-5 | 50 Ohm BNC Series | 7 |
| M39012/02-0006 | KN-19-110 | N Series | 34 | M39012/16B0004 | KC-59-61 | 50 Ohm BNC Series | 6 |
| M39012/02-0131 | KN-39-102 | N Series | 33 | M39012/16B0004 | KC-59-195 | 50 Ohm BNC Series | 7 |
| M39012/02-0501 | KN-39-83 | N Series | 33 | M39012/16B0007 | KC-59-188 | 50 Ohm BNC Series | 6 |
| M39012/02-0503 | KN-39-86 | N Series | 33 | M39012/16B0008 | KC-59-220 | 50 Ohm BNC Series | 7 |
| M39012/02-0513 | KN-19-148 | N Series | 35 | M39012/16B0009 | KC-59-111 | 50 Ohm BNC Series | 6 |
| M39012/03-0012 | KN-19-114 | N Series | 33 | M39012/17-0014 | KC-39-93 | 50 Ohm BNC Series | 10 |
| M39012/03-0501 | KN-19-149 | N Series | 34 | M39012/17-0020 | KC-39-98 | 50 Ohm BNC Series | 10 |
| M39012/03-0502 | KN-19-150 | N Series | 34 | M39012/17-0101 | KC-39-03 | 50 Ohm BNC Series | 11 |
| M39012/03-0503 | KN-19-151 | N Series | 34 | M39012/17-0502 | KC-39-105 | 50 Ohm BNC Series | 10 |
| M39012/03-0504 | 1202-2-5 | N Series | 34 | M39012/17-0503 | KC-39-106 | 50 Ohm BNC Series | 10 |
| M39012/04-0001 | KN-79-69 | N Series | 39 | M39012/17-0504 | KC-39-103 | 50 Ohm BNC Series | 10 |
| M39012/04-0002 | KN-79-70 | N Series | 39 | M39012/18-0102 | KC-19-02 | 50 Ohm BNC Series | 10 |
| M39012/05-0101 | KN-59-298 | N Series | 36 | M39012/18-0502 | KC-19-244 | 50 Ohm BNC Series | 10 |
| M39012/05-0501 | KN-59-243 | N Series | 37 | M39012/18-0503 | KC-19-245 | 50 Ohm BNC Series | 10 |
| M39012/05-0502 | KN-59-244 | N Series | 37 | M39012/18B0007 | KC-19-129 | 50 Ohm BNC Series | 10 |
| M39012/05-0503 | KN-59-245 | N Series | 37 | M39012/19-0013 | KC-19-207 | 50 Ohm BNC Series | 9 |
| M39012/05-0504 | 1206-5-5 | N Series | 37 | M39012/19-0014 | KC-19-208 | 50 Ohm BNC Series | 9 |
| M39012/06-0002 | KD-59-119 | C Series | 22 | M39012/19-0020 | KC-19-212 | 50 Ohm BNC Series | 9 |
| M39012/06-0003 | KD-59-133 | C Series | 22 | M39012/19-0101 | KC-19-282 | 50 Ohm BNC Series | 9 |
| M39012/06-0014 | 795-10-5 | C Series | 22 | M39012/19-0220 | 752-34-5 | 50 Ohm BNC Series | 9 |
| M39012/06-0015 | 795-9-5 | C Series | 22 | M39012/19-0502 | KC-19-248 | 50 Ohm BNC Series | 9 |
| M39012/08-0001 | KD-19-72 | C Series | 23 | M39012/19-0503 | KC-19-249 | 50 Ohm BNC Series | 9 |
| M39012/09-0002 | KD-19-65 | C Series | 23 | M39012/19-0504 | KC-19-250 | 50 Ohm BNC Series | 9 |
| M39012/10-0001 | KD-59-134 | C Series | 21 | M39012/19B0003 | KC-19-50 | 50 Ohm BNC Series | 9 |
| M39012/11-0001 | KD-19-61 | C Series | 23 | M39012/20-0006 | 756-21-7 | 50 Ohm BNC Series | 8 |
| M39012/11-0002 | KD-19-73 | C Series | 23 | M39012/20-0007 | 756-19-7 | 50 Ohm BNC Series | 8 |
| M39012/12-0001 | KD-79-14 | C Series | 23 | M39012/20-0101 | KC-59-533 | 50 Ohm BNC Series | 8 |
| M39012/128-0001 | 754-21-5 | 50 Ohm BNC Series | 13 | M39012/20-0101 | 756-9-5 | 50 Ohm BNC Series | 8 |
| M39012/13-0001 | KD-79-13 | C Series | 23 | M39012/20-0102 | 756-12-5 | 50 Ohm BNC Series | 8 |
| M39012/15-0001 | KD-59-135 | C Series | 22 | M39012/20-0501 | KC-59-408 | 50 Ohm BNC Series | 8 |
| M39012/15-0002 | KD-59-130 | C Series | 22 | M39012/20-0502 | KC-59-418 | 50 Ohm BNC Series | 8 |
| M39012/16-0001 | KD-59-132 | C Series | 22 | M39012/20-0503 | KC-59-419 | 50 Ohm BNC Series | 8 |
| M39012/16-0013 | 755-114-5 | 50 Ohm BNC Series | 7 | M39012/20-0504 | KC-59-420 | 50 Ohm BNC Series | 8 |
| M39012/16-0014 | 755-112-5 | 50 Ohm BNC Series | 7 | M39012/20B0003 | KC-59-246 | 50 Ohm BNC Series | 8 |

| Military PN | KINGS® PN | Product Family | Page Number |
|----------------|-----------|-------------------|-------------|
| M39012/21-0001 | KC-79-105 | 50 Ohm BNC Series | 13 |
| M39012/21-0002 | KC-79-106 | 50 Ohm BNC Series | 13 |
| M39012/22-0001 | KC-79-109 | 50 Ohm BNC Series | 12 |
| M39012/23-0001 | KC-79-110 | 50 Ohm BNC Series | 13 |
| M39012/23-0002 | KC-79-111 | 50 Ohm BNC Series | 13 |
| M39012/24-0001 | KC-79-107 | 50 Ohm BNC Series | 13 |
| M39012/24-0002 | KC-79-108 | 50 Ohm BNC Series | 13 |
| M39012/25-0002 | KD-89-08 | C Series | 21 |
| M39012/25-0006 | KC-89-87 | 50 Ohm BNC Series | 11 |
| M39012/25-0007 | KC-89-88 | 50 Ohm BNC Series | 11 |
| M39012/25-0008 | KC-89-89 | 50 Ohm BNC Series | 11 |
| M39012/25-0011 | KN-89-30 | N Series | 41 |
| M39012/25-0012 | KN-89-31 | N Series | 41 |
| M39012/25-0015 | KC-89-92 | 50 Ohm BNC Series | 11 |
| M39012/25-0016 | KC-89-93 | 50 Ohm BNC Series | 11 |
| M39012/25-0018 | KA-81-02 | TNC Series | 80 |
| M39012/25-0020 | KA-81-01 | TNC Series | 80 |
| M39012/25-0021 | KA-89-82 | TNC Series | 80 |
| M39012/25-0106 | 758-8-5 | 50 Ohm BNC Series | 11 |
| M39012/25-0118 | 128-26-5 | TNC Series | 80 |
| M39012/25-0120 | 128-25-5 | TNC Series | 80 |
| M39012/26-0010 | KA-59-231 | TNC Series | 77 |
| M39012/26-0011 | KA-59-230 | TNC Series | 77 |
| M39012/26-0012 | KA-59-232 | TNC Series | 77 |
| M39012/26-0013 | KA-59-289 | TNC Series | 73 |
| M39012/26-0021 | KA-59-279 | TNC Series | 77 |
| M39012/26-0022 | 125-19-5 | TNC Series | 77 |
| M39012/26-0101 | KA-59-22 | TNC Series | 73 |
| M39012/26-0101 | 125-67-5 | TNC Series | 73 |
| M39012/26-0102 | KA-59-18 | TNC Series | 73 |
| M39012/26-0501 | KA-59-290 | TNC Series | 77 |
| M39012/26-0502 | KA-59-291 | TNC Series | 77 |
| M39012/26-0503 | KA-59-292 | TNC Series | 77 |
| M39012/26-0504 | KA-59-287 | TNC Series | 77 |
| M39012/27-0101 | KA-39-87 | TNC Series | 67 |
| M39012/27-0503 | KA-39-79 | TNC Series | 67 |
| M39012/27-0504 | KA-39-76 | TNC Series | 67 |
| M39012/28-0010 | KA-19-101 | TNC Series | 68 |
| M39012/28-0011 | KA-19-102 | TNC Series | 68 |
| M39012/28-0018 | 122-32-5 | TNC Series | 68 |
| M39012/28-0018 | KA-19-171 | TNC Series | 68 |
| M39012/28-0021 | KA-19-146 | TNC Series | 68 |
| M39012/28-0022 | 122-3-5 | TNC Series | 68 |
| M39012/28-0101 | KA-19-19 | TNC Series | 68 |
| M39012/28-0101 | 122-27-5 | TNC Series | 68 |
| M39012/28-0102 | KA-19-172 | TNC Series | 68 |
| M39012/28-0502 | KA-19-151 | TNC Series | 68 |

| Military PN | KINGS® PN | Product Family | Page Number |
|----------------|-----------|----------------|-------------|
| M39012/28-0503 | KA-19-152 | TNC Series | 68 |
| M39012/28-0504 | KA-19-153 | TNC Series | 68 |
| M39012/29-0014 | KA-19-110 | TNC Series | 69 |
| M39012/29-0018 | KA-19-181 | TNC Series | 67 |
| M39012/29-0022 | KA-19-214 | TNC Series | 69 |
| M39012/29-0101 | KA-19-176 | TNC Series | 67 |
| M39012/29-0502 | KA-19-155 | TNC Series | 69 |
| M39012/29-0503 | KA-19-156 | TNC Series | 69 |
| M39012/29-0504 | KA-19-157 | TNC Series | 69 |
| M39012/30-0010 | KA-59-235 | TNC Series | 72 |
| M39012/30-0011 | KA-59-236 | TNC Series | 72 |
| M39012/30-0012 | KA-59-237 | TNC Series | 72 |
| M39012/30-0022 | 126-8-5 | TNC Series | 72 |
| M39012/30-0101 | KA-59-343 | TNC Series | 73 |
| M39012/30-0101 | 126-55-5 | TNC Series | 73 |
| M39012/30-0102 | 126-54-5 | TNC Series | 73 |
| M39012/30-0118 | KA-59-348 | TNC Series | 73 |
| M39012/30-0502 | KA-59-295 | TNC Series | 72 |
| M39012/30-0503 | KA-59-296 | TNC Series | 72 |
| M39012/30-0504 | KA-59-297 | TNC Series | 72 |
| M39012/31-0001 | KA-71-02 | TNC Series | 78 |
| M39012/31-0002 | KA-71-08 | TNC Series | 78 |
| M39012/32-0001 | KA-79-39 | TNC Series | 78 |
| M39012/34-0001 | KA-71-03 | TNC Series | 78 |
| M39012/34-0002 | KA-71-04 | TNC Series | 78 |
| M39012/55-3007 | 875-81-17 | SMA Series | 49 |
| M39012/55-3009 | 875-82-17 | SMA Series | 49 |
| M39012/55-3109 | 875-82-3 | SMA Series | 49 |
| M39012/55-3130 | 875-86-3 | SMA Series | 49 |
| M39012/55-3502 | 875-21-17 | SMA Series | 58 |
| M39012/55-3602 | 875-21-3 | SMA Series | 58 |
| M39012/55-4502 | 875-21-18 | SMA Series | 58 |
| M39012/55B3112 | 875-9-3 | SMA Series | 58 |
| M39012/55B3114 | 875-1-3 | SMA Series | 58 |
| M39012/55B3116 | 875-3-3 | SMA Series | 58 |
| M39012/56-3009 | 876-61-17 | SMA Series | 49 |
| M39012/56-3030 | 876-62-17 | SMA Series | 49 |
| M39012/56-3107 | 876-60-3 | SMA Series | 49 |
| M39012/56-3130 | 876-62-3 | SMA Series | 49 |
| M39012/56B3114 | 873-1-3 | SMA Series | 51 |
| M39012/57-3502 | 873-18-3 | SMA Series | 51 |
| M39012/57-4502 | 873-18 | SMA Series | 51 |
| M39012/58B4012 | 871-13 | SMA Series | 51 |
| M39012/61-3002 | 874-11-3 | SMA Series | 57 |
| M39012/61-3002 | 874-2-3 | SMA Series | 57 |
| M39012/61-4001 | 874-1 | SMA Series | 57 |
| M39012/79-3008 | 875-70-17 | SMA Series | 49 |

MILITARY CROSS REFERENCE

| Military PN | KINGS® PN | Product Family | Page Number |
|-----------------|-----------|-------------------|-------------|
| M39012/79-3107 | 875-69-3 | SMA Series | 49 |
| M39012/79-3108 | 875-70-3 | SMA Series | 49 |
| M39012/80-3108 | 876-49-3 | SMA Series | 49 |
| M39012/81-3008 | 873-19-3 | SMA Series | 48 |
| M39012/82-3008 | 871-38-3 | SMA Series | 51 |
| M39012/83-3007 | 872-36-3 | SMA Series | 48 |
| M39012/83-3008 | 872-37-3 | SMA Series | 48 |
| M39012/93-3001 | 877-86-1 | SMA Series | 57 |
| M39012/93-3002 | 877-92-1 | SMA Series | 57 |
| M39012/93-3003 | 877-93-1 | SMA Series | 57 |
| M39012/94-3001 | 877-87-1 | SMA Series | 57 |
| M39012/94-3002 | 877-94-1 | SMA Series | 57 |
| M39012/94-3003 | 877-95-1 | SMA Series | 57 |
| M49142/03-0004 | 1995-12-5 | TRB Series | 82 |
| M49142/03-0007 | 1995-11-5 | TRB Series | 82 |
| M49142/03-0008 | 1995-14-5 | TRB Series | 82 |
| M49142/04-0004 | 1994-3-5 | TRB Series | 83 |
| M49142/04-0005 | 1994-4-5 | TRB Series | 83 |
| M49142/05-0004 | 1992-9-5 | TRB Series | 83 |
| M49142/08-0002 | 1945-13-5 | TRT Series | 85 |
| M49142/09-0006 | 1942-7-5 | TRT Series | 85 |
| M49142/10-0001 | 1944-3-5 | TRT Series | 85 |
| M49142/10-0002 | 1944-8-5 | TRT Series | 85 |
| M55339/03-00027 | 1209-10 | N Series | 40 |
| M55339/04-00001 | 1209-19 | N Series | 40 |
| M55339/04-00030 | 1209-12 | N Series | 40 |
| M55339/05-00057 | 1209-9 | N Series | 40 |
| M55339/07-00029 | 1209-13 | N Series | 40 |
| M55339/10-00567 | 799-5 | C Series | 21 |
| M55339/13-00001 | 759-9 | 50 Ohm BNC Series | 14 |
| M55339/13-00492 | 759-2 | 50 Ohm BNC Series | 14 |
| M55339/14-00306 | 759-4 | 50 Ohm BNC Series | 15 |
| M55339/15-00491 | 759-5 | 50 Ohm BNC Series | 14 |
| M55339/16-00914 | 759-1 | 50 Ohm BNC Series | 14 |
| M55339/17-00274 | 759-3 | 50 Ohm BNC Series | 15 |
| M55339/35-00001 | 129-4 | TNC Series | 79 |
| M55339/50-00001 | 129-6 | TNC Series | 79 |

| Part Number | Page |
|-------------|------|
| 1941-6-9 | 85 |
| 1942-7-5 | 85 |
| 1944-1-9 | 85 |
| 1944-3-5 | 85 |
| 1944-8-5 | 85 |
| 1947-5-9 | 85 |
| 1960-1-9 | 83 |
| 1962-7-9 | 83 |
| 1964-1-9 | 83 |
| 1964-3-9 | 83 |
| 1965-5-9 | 82 |
| 1965-12-9 | 82 |
| 1966-6-5 | 82 |
| 1967-4-3 | 83 |
| 1992-9-5 | 83 |
| 1994-1-9 | 83 |
| 1994-3-5 | 83 |
| 1994-4-5 | 83 |
| 1994-12-9 | 83 |
| 1995-3-9 | 82 |
| 1995-11-5 | 82 |
| 1995-12-5 | 82 |
| 1998-2-9 | 82 |
| 1998-6-5 | 82 |
| 1998-8-5 | 83 |
| 1999-1-4 | 82 |
| 2024-7-9 | 100 |
| 2029-9-9 | 100 |
| 2065-1-9 | 101 |
| 2065-2-9 | 101 |
| 2065-7-9 | 101 |
| 2065-8-9 | 101 |
| 2065-10-9 | 101 |
| 2065-11-9 | 101 |
| 2430-2-16 | 69 |
| 2436-6-3 | 74 |
| 2437-4-5 | 77 |
| 2439-1-1 | 79 |
| 2439-1-6 | 79 |
| 2439-1-11 | 79 |
| 2439-1-16 | 79 |
| 2439-5-1 | 79 |
| 2439-5-6 | 79 |
| 2439-5-9 | 79 |
| 2439-5-16 | 79 |
| 2439-6-1 | 79 |
| 2439-6-6 | 79 |

| Part Number | Page |
|-------------|------|
| 2439-6-9 | 79 |
| 2724-2-5 | 83 |
| 2954-1-5 | 83 |
| 2971-2-1 | 35 |
| 2971-2-11 | 35 |
| 2971-2-16 | 35 |
| 2971-3-1 | 35 |
| 2971-3-6 | 35 |
| 2971-3-11 | 35 |
| 2971-3-16 | 35 |
| 2971-7-1 | 35 |
| 2971-7-6 | 35 |
| 2971-7-11 | 35 |
| 2971-7-16 | 35 |
| 2971-8-1 | 35 |
| 2971-8-6 | 35 |
| 2971-8-11 | 35 |
| 2971-8-16 | 35 |
| 2975-2-1 | 38 |
| 2975-2-6 | 38 |
| 2975-2-11 | 38 |
| 2975-2-16 | 38 |
| 2975-4-1 | 38 |
| 2975-4-6 | 38 |
| 2975-4-11 | 38 |
| 2975-4-16 | 38 |
| 2975-5-1 | 38 |
| 2975-5-6 | 37 |
| 2975-5-11 | 37 |
| 2975-5-16 | 37 |
| 2975-6-1 | 38 |
| 2975-6-6 | 38 |
| 2975-6-11 | 38 |
| 2975-6-16 | 38 |
| 2981-1-1 | 46 |
| 2981-1-6 | 46 |
| 2981-1-11 | 46 |
| 2981-1-16 | 46 |
| 2981-3-1 | 46 |
| 2981-3-6 | 46 |
| 2981-3-11 | 46 |
| 2981-3-16 | 46 |
| 2981-5-1 | 46 |
| 2981-5-6 | 46 |
| 2981-5-11 | 46 |
| 2981-5-16 | 46 |
| 2981-7-1 | 46 |

| Part Number | Page |
|-------------|------|
| 2981-7-6 | 46 |
| 2981-7-11 | 46 |
| 2981-7-16 | 46 |
| 2981-8-1 | 46 |
| 2981-8-6 | 46 |
| 2981-8-11 | 46 |
| 2981-8-16 | 46 |
| 2981-11-1 | 46 |
| 2981-11-6 | 46 |
| 2981-11-11 | 46 |
| 2981-11-16 | 46 |
| 2985-2-1 | 45 |
| 2985-2-6 | 45 |
| 2985-2-11 | 45 |
| 2985-2-16 | 45 |
| 2985-3-1 | 45 |
| 2985-3-6 | 45 |
| 2985-3-11 | 45 |
| 2985-3-16 | 45 |
| 2985-6-1 | 45 |
| 2985-6-6 | 45 |
| 2985-6-11 | 45 |
| 2985-6-16 | 45 |
| 2985-7-1 | 45 |
| 2985-7-6 | 45 |
| 2985-7-11 | 45 |
| 2985-7-16 | 45 |
| 2986-1-6 | 46 |
| 2986-1-16 | 46 |
| 2986-3-1 | 46 |
| 2986-3-6 | 46 |
| 2986-3-11 | 46 |
| 2986-3-16 | 46 |
| 2986-4-1 | 46 |
| 2986-4-6 | 46 |
| 2986-4-11 | 46 |
| 2986-4-16 | 46 |
| 3050-10-9 | 131 |
| 3050-11-9 | 131 |
| 3050-12-9 | 131 |
| 780270 | 114 |
| 780273 | 114 |
| 780274 | 114 |
| 780276 | 114 |
| 780280 | 114 |
| 780290 | 114 |
| 780370 | 114 |

| Part Number | Page |
|-----------------|------|
| 780373 | 114 |
| 780374 | 114 |
| 780376 | 114 |
| 780380 | 114 |
| 780390 | 114 |
| 780570 | 115 |
| 780573 | 115 |
| 780574 | 115 |
| 780576 | 115 |
| 780580 | 115 |
| 780590 | 115 |
| 780670 | 115 |
| 780673 | 115 |
| 780674 | 115 |
| 780676 | 115 |
| 780680 | 115 |
| 780690 | 115 |
| 781273 | 114 |
| 783870 | 115 |
| 783873 | 115 |
| 783874 | 115 |
| 783876 | 115 |
| 783880 | 115 |
| 783890 | 115 |
| 785870 | 115 |
| 785873 | 115 |
| 785874 | 115 |
| 785876 | 115 |
| 785880 | 115 |
| 785890 | 115 |
| 1-8603 | 129 |
| 8605-3-9 | 119 |
| 8608-2-9 | 119 |
| 2065-E00-C7102N | 103 |
| 2065-E00-C7202N | 103 |
| 2065-E00-C9004N | 103 |
| 512-900-0630H | 62 |
| KP-8001-001-012 | 111 |
| KP-8001-002-012 | 111 |
| KP-8002-002-012 | 111 |
| 0345-E00-C7201N | 117 |
| 0345-E00-C7202N | 117 |
| 034B-060-00401H | 119 |
| 1064-1 QD | 87 |
| 1065-1 QD | 87 |
| 1065-2 | 87 |
| 1069-1 | 87 |

PART NUMBER INDEX

| Part Number | Page | Part Number | Page | Part Number | Page | Part Number | Page |
|--------------|------|---------------|------|-------------|------|-------------|------|
| 1074-1 QD | 25 | 1205-37-5 | 36 | 1209-19 | 40 | 125-67-5 | 73 |
| 1074-4 | 25 | 1205-43-5 | 36 | 1209-44-5 | 40 | 125-69-9 | 76 |
| 1074-5 | 25 | 1205-45-5 | 36 | 1209-74-22 | 40 | 125-80-9 | 77 |
| 1075-1 | 25 | 1205-47-9 | 38 | 1209-9 | 40 | 125-86-1 | 75 |
| 1075-13-9 | 25 | 1205-48-9 | 38 | 121-11-9 | 69 | 125-88-9 | 76 |
| 1075-2 | 25 | 1205-4-9 | 38 | 121-25-5 | 67 | 125-89-9 | 76 |
| 1079-7 | 25 | 1205-49-9 | 38 | 121-35-9 | 69 | 125-91-9 | 76 |
| 1200-2-5 | 36 | 1205-59-5 | 38 | 121-36-9 | 69 | 125-92-9 | 76 |
| 1201-12-9 | 35 | 1205-61-9 | 37 | 121-37-9 | 69 | 125-94-9 | 76 |
| 1201-13-9 | 35 | 1205-62-7 | 38 | 121-38-9 | 69 | 125-95-7 | 76 |
| 1201-14-9 | 35 | 1205-62-9 | 38 | 121-39-7 | 69 | 125-95-9 | 76 |
| 1201-21-9 | 35 | 1205-64-3 | 36 | 121-39-9 | 69 | 125-96-9 | 76 |
| 1201-22-9 | 35 | 1205-65-5 | 38 | 121-40-9 | 69 | 125-98-9 | 76 |
| 1201-23-9 | 35 | 1205-67-9 | 38 | 121-44-9 | 69 | 126-1-2 | 74 |
| 1201-24-9 | 35 | 1205-68-5 | 38 | 121-45-9 | 69 | 126-12-5 | 72 |
| 1201-25-9 | 35 | 1205-69-5 | 38 | 121-46-9 | 69 | 126-14-5 | 72 |
| 1201-6-9 | 35 | 1205-77-9 | 38 | 121-52-9 | 69 | 126-35-9 | 72 |
| 1201-9-5 | 34 | 1205-78-101 | 36 | 122-27-5 | 68 | 126-4-1 | 74 |
| 1202-15-5 | 33 | 1205-79-101 | 36 | 122-32-5 | 68 | 126-54-5 | 73 |
| 1202-16-5 | 33 | 120-600-0000R | 43 | 122-3-5 | 68 | 126-55-5 | 73 |
| 1202-20-9 | 34 | 120-601-0000R | 43 | 122-37-9 | 68 | 126-58-9 | 72 |
| 1202-21-5 | 34 | 1206-11-9 | 37 | 122-50-5 | 68 | 126-59-9 | 72 |
| 1202-22-5 | 34 | 1206-16-9 | 37 | 122-55-9 | 68 | 126-63-9 | 72 |
| 1202-23-9 | 34 | 1206-21-9 | 37 | 123-22-5 | 67 | 126-64-9 | 72 |
| 1202-2-5 | 34 | 1206-22-9 | 37 | 123-23-9 | 67 | 126-68-5 | 72 |
| 1202-25-5 | 34 | 1206-26-9 | 37 | 123-24-9 | 68 | 126-69-5 | 72 |
| 1202-26-9 | 34 | 1206-29-9 | 37 | 123-27-9 | 67 | 126-70-9 | 72 |
| 1202-35-9 | 34 | 1206-30-9 | 37 | 123-28-9 | 68 | 126-71-7 | 72 |
| 1203-13-9 | 33 | 1206-31-5 | 37 | 125-101-9 | 76 | 126-71-9 | 72 |
| 1203-14-9 | 33 | 1206-35-5 | 36 | 125-103-5 | 77 | 126-73-9 | 72 |
| 1203-15-9 | 34 | 1206-37-9 | 37 | 125-104-5 | 77 | 126-74-9 | 72 |
| 1203-16-9 | 33 | 1206-45-22 | 36 | 125-105-9 | 76 | 126-79-5 | 72 |
| 1203-18-5 | 33 | 1206-5-5 | 37 | 125-1-1 | 75 | 126-8-5 | 72 |
| 1203-19-9 | 33 | 1207-14-9 | 39 | 125-114-5 | 77 | 126-85-9 | 72 |
| 1203-20-9 | 33 | 1207-27-5 | 39 | 125-117-9 | 76 | 126-86-3 | 72 |
| 1203-21-9 | 33 | 1207-29-9 | 39 | 125-1-6 | 75 | 127-15 | 78 |
| 1203-23-9 | 33 | 1208-10-5 | 39 | 125-19-5 | 77 | 127-19-9 | 78 |
| 1203-24-9 | 33 | 1208-28-5 | 39 | 125-25-5 | 73 | 127-20-9 | 78 |
| 1203-4-9 | 33 | 1208-45-5 | 41 | 125-4-1 | 75 | 127-26-9 | 77 |
| 120-351-000R | 43 | 1208-46-5 | 41 | 125-4-2 | 75 | 128-17-5 | 80 |
| 1204-12-5 | 39 | 120-900-1160R | 43 | 125-52-1 | 75 | 128-25-5 | 80 |
| 1204-17-5 | 39 | 120-900-1161R | 43 | 125-52-2 | 75 | 128-26-5 | 80 |
| 1204-20-9 | 39 | 120-900-2000R | 43 | 125-52-3 | 75 | 128-30-9 | 77 |
| 1205-19-5 | 38 | 120-900-2400R | 43 | 125-52-4 | 75 | 128-31-5 | 80 |
| 1205-30-9 | 38 | 1209-10 | 40 | 125-57-9 | 76 | 128-32-9 | 80 |
| 1205-31-9 | 38 | 1209-12 | 40 | 125-58-9 | 76 | 128-33-5 | 80 |
| 1205-35-5 | 36 | 1209-13 | 40 | 125-61-9 | 76 | 128-3-5 | 80 |

| Part Number | Page |
|---------------|------|
| 129-23-9 | 79 |
| 129-26-9 | 79 |
| 129-29-9 | 79 |
| 129-4 | 79 |
| 129-6 | 79 |
| 129-6 M06 | 79 |
| 1340-1 | 13 |
| 1345-3-31 | 13 |
| 1345-4-31 | 13 |
| 1385-13-9 | 39 |
| 1385-17-9 | 39 |
| 150-500-0850N | 60 |
| 150-500-1410N | 60 |
| 150-900-0630N | 60 |
| 150-900-0631N | 60 |
| 152-500-0850N | 60 |
| 152-500-1410N | 60 |
| 152-900-0630N | 60 |
| 152-900-0631N | 60 |
| 1685-2-5 | 94 |
| 1702-1 | 98 |
| 1702-2 | 98 |
| 1702-4-11 | 98 |
| 1704-1 QD | 97 |
| 1704-1-11 M06 | 97 |
| 1704-2 | 97 |
| 1704-3-9 | 97 |
| 1705-1 | 98 |
| 1705-14 | 98 |
| 1705-16 M06 | 98 |
| 1705-16-11 | 98 |
| 1705-2 | 98 |
| 1705-2-1 | 98 |
| 1705-21-9 | 98 |
| 1705-3 | 98 |
| 1705-4 | 98 |
| 1707-1 | 98 |
| 1709-1 | 97 |
| 1709-1-11 | 97 |
| 1709-12 M06 | 97 |
| 1709-2 | 97 |
| 1709-3 | 97 |
| 1709-5 | 97 |
| 1725-1 | 25 |
| 1764-1 | 89 |
| 1764-2 | 89 |
| 1765-1 | 89 |

| Part Number | Page |
|--------------|------|
| 1800-10 | 73 |
| 1800-11 | 73 |
| 1800-4 | 73 |
| 1800-6 | 73 |
| 1800-7 | 73 |
| 1-8065-1 | 128 |
| 1-8065-10 | 128 |
| 1-8065-2 | 128 |
| 1-8065-3 | 128 |
| 1-8065-4 | 128 |
| 1-8065-5 | 128 |
| 1-8065-6 | 128 |
| 1-8065-7 | 128 |
| 1-8065-8 | 128 |
| 1-8065-9 | 128 |
| 1-8066-1 | 128 |
| 1-8066-10 | 128 |
| 1-8066-2 | 128 |
| 1-8066-3 | 128 |
| 1-8066-4 | 128 |
| 1-8066-5 | 128 |
| 1-8066-6 | 128 |
| 1-8066-7 | 128 |
| 1-8066-8 | 128 |
| 1-8066-9 | 128 |
| 1-8114-1 QD | 128 |
| 1-8114-10 QD | 128 |
| 1-8114-2 QD | 128 |
| 1-8114-3 QD | 128 |
| 1-8114-4 QD | 128 |
| 1-8114-5 QD | 128 |
| 1-8114-6 QD | 128 |
| 1-8114-7 QD | 128 |
| 1-8114-8 QD | 128 |
| 1-8114-9 QD | 128 |
| 1-8115-1 QD | 128 |
| 1-8115-10 QD | 129 |
| 1-8115-2 QD | 128 |
| 1-8115-3 QD | 128 |
| 1-8115-4 QD | 128 |
| 1-8115-5 QD | 128 |
| 1-8115-6 QD | 128 |
| 1-8115-7 QD | 129 |
| 1-8115-8 QD | 129 |
| 1-8115-9 QD | 129 |
| 1-8574-1 | 129 |
| 1-8574-10 | 129 |

| Part Number | Page |
|--------------|------|
| 1-8574-2 | 129 |
| 1-8574-3 | 129 |
| 1-8574-4 | 129 |
| 1-8574-5 | 129 |
| 1-8574-6 | 129 |
| 1-8574-7 | 129 |
| 1-8574-8 | 129 |
| 1-8574-9 | 129 |
| 1-8575-1 QD | 129 |
| 1-8575-10 QD | 129 |
| 1-8575-2 QD | 129 |
| 1-8575-3 QD | 129 |
| 1-8575-4 QD | 129 |
| 1-8575-5 QD | 129 |
| 1-8575-6 QD | 129 |
| 1-8575-7 QD | 129 |
| 1-8575-8 QD | 129 |
| 1-8575-9 QD | 129 |
| 1-8576-1 QD | 129 |
| 1-8576-10 QD | 129 |
| 1-8576-2 QD | 129 |
| 1-8576-3 QD | 129 |
| 1-8576-4 QD | 129 |
| 1-8576-5 QD | 129 |
| 1-8576-6 QD | 129 |
| 1-8576-7 QD | 129 |
| 1-8576-8 QD | 129 |
| 1-8576-9 QD | 129 |
| 1-8577-1 QD | 129 |
| 1-8577-10 QD | 129 |
| 1-8577-2 QD | 129 |
| 1-8577-3 QD | 129 |
| 1-8577-4 QD | 129 |
| 1-8577-5 QD | 129 |
| 1-8577-6 QD | 129 |
| 1-8577-7 QD | 129 |
| 1-8577-8 QD | 129 |
| 1-8577-9 QD | 129 |
| 1945-13-5 | 85 |
| 1945-19-102 | 85 |
| 1945-35-9 | 85 |
| 1962-2 | 83 |
| 1965-2 | 82 |
| 1965-28-5 | 82 |
| 1992-12-102 | 83 |
| 1995-14-5 | 82 |
| 1995-26-102 | 82 |

| Part Number | Page |
|---------------|------|
| 1996-14-5 | 82 |
| 2022-17-29 | 100 |
| 2022-18-29 | 100 |
| 2022-28-9 | 100 |
| 2022-29-9 | 100 |
| 2022-32-9 | 100 |
| 2024-16-9 | 100 |
| 2025-44-9 | 101 |
| 2025-44-9 M66 | 101 |
| 2025-76-9 | 101 |
| 2026-16-9 | 101 |
| 2026-17-9 | 101 |
| 2026-33-9 | 101 |
| 2026-34-9 | 101 |
| 2026-35-9 | 101 |
| 2026-35-9 M66 | 101 |
| 2026-36-9 | 101 |
| 2026-36-9 M66 | 101 |
| 2027-17-29 | 100 |
| 2029-15-9 | 100 |
| 2029-16-9 | 100 |
| 2029-17-9 QD | 100 |
| 2029-20-9 | 100 |
| 2029-33-9 | 100 |
| 2065-10-9 M66 | 101 |
| 2065-11-9 M66 | 101 |
| 2065-15-9 | 101 |
| 2065-15-9 M66 | 101 |
| 2065-1-9 M66 | 101 |
| 2065-28-9 | 101 |
| 2065-2-9 M66 | 101 |
| 2065-29-9 | 101 |
| 2065-7-9 M66 | 101 |
| 2065-8-9 M66 | 101 |
| 2431-74-1 | 71 |
| 2431-74-11 | 71 |
| 2431-74-16 | 71 |
| 2431-74-2 | 71 |
| 2431-74-3 | 71 |
| 2431-74-4 | 71 |
| 2431-74-6 | 71 |
| 2431-76-1 | 70 |
| 2431-76-11 | 70 |
| 2431-76-16 | 70 |
| 2431-76-6 | 70 |
| 2431-78-10 | 67 |
| 2431-78-5 | 67 |

PART NUMBER INDEX

| Part Number | Page | Part Number | Page | Part Number | Page | Part Number | Page |
|-------------|------|-------------|------|---------------|------|---------------|------|
| 2431-80-1 | 70 | 2431-91-1 | 71 | 2436-81-16 | 74 | 251-055-0025P | 55 |
| 2431-80-11 | 70 | 2431-91-11 | 71 | 2436-81-2 | 74 | 251-055-0030G | 55 |
| 2431-80-16 | 70 | 2431-91-6 | 71 | 2436-81-21 | 74 | 251-055-0030P | 55 |
| 2431-80-20 | 70 | 2435-74-1 | 75 | 2436-81-6 | 74 | 251-055-0031G | 55 |
| 2431-80-6 | 70 | 2435-74-11 | 75 | 2436-82-1 | 74 | 251-055-0031P | 55 |
| 2431-81-1 | 70 | 2435-74-16 | 75 | 2436-82-10 | 74 | 251-055-0040G | 52 |
| 2431-81-11 | 70 | 2435-74-3 | 75 | 2436-82-5 | 74 | 251-055-0040P | 52 |
| 2431-81-16 | 70 | 2435-74-6 | 75 | 2436-83-1 | 74 | 251-055-0041G | 52 |
| 2431-81-2 | 70 | 2435-77-1 | 74 | 2436-83-11 | 74 | 251-055-0041P | 52 |
| 2431-81-6 | 70 | 2435-77-11 | 74 | 2436-83-16 | 74 | 251-060-0040G | 57 |
| 2431-81-9 | 70 | 2435-77-16 | 74 | 2436-83-24 | 74 | 251-065-0022G | 55 |
| 2431-82-1 | 71 | 2435-77-6 | 74 | 2436-83-6 | 74 | 251-065-0022P | 55 |
| 2431-82-11 | 71 | 2435-81-1 | 75 | 2436-83-9 | 74 | 251-065-0023G | 55 |
| 2431-82-16 | 71 | 2435-81-11 | 75 | 2436-85-1 | 74 | 251-065-0023P | 55 |
| 2431-82-2 | 71 | 2435-81-16 | 75 | 2436-85-6 | 74 | 251-065-0024G | 55 |
| 2431-82-5 | 71 | 2435-81-2 | 75 | 2437-2-0 | 78 | 251-065-0024P | 55 |
| 2431-82-6 | 71 | 2435-81-20 | 75 | 250-500-0850G | 49 | 251-065-0025G | 55 |
| 2431-83-1 | 71 | 2435-81-5 | 75 | 250-500-0850P | 49 | 251-065-0025P | 55 |
| 2431-83-11 | 71 | 2435-81-6 | 75 | 250-500-0853G | 49 | 251-065-0030G | 55 |
| 2431-83-16 | 71 | 2435-81-9 | 75 | 250-500-0853P | 49 | 251-065-0030P | 55 |
| 2431-84-1 | 70 | 2435-82-1 | 75 | 250-500-0858G | 49 | 251-065-0031G | 55 |
| 2431-84-11 | 70 | 2435-82-6 | 75 | 250-500-0858P | 49 | 251-065-0031P | 55 |
| 2431-84-16 | 70 | 2435-83-1 | 75 | 250-500-1410G | 49 | 251-065-0040G | 52 |
| 2431-84-2 | 70 | 2435-83-11 | 75 | 250-500-1410P | 49 | 251-065-0040P | 52 |
| 2431-84-5 | 70 | 2435-83-16 | 75 | 250-500-1411G | 49 | 251-065-0041G | 52 |
| 2431-84-6 | 69 | 2435-83-6 | 75 | 250-500-1411P | 49 | 251-065-0041P | 52 |
| 2431-85-1 | 70 | 2435-84-1 | 75 | 250-500-1412G | 49 | 251-066-0022G | 55 |
| 2431-85-11 | 70 | 2435-84-11 | 75 | 250-500-1412P | 49 | 251-066-0022P | 55 |
| 2431-85-16 | 70 | 2435-84-16 | 75 | 250-500-1413G | 49 | 251-066-0023G | 55 |
| 2431-85-6 | 70 | 2435-84-3 | 75 | 250-500-1413P | 49 | 251-066-0023P | 55 |
| 2431-87-1 | 70 | 2435-84-5 | 75 | 250-500-1418G | 49 | 251-066-0024G | 55 |
| 2431-87-11 | 71 | 2435-84-6 | 75 | 250-500-1418P | 49 | 251-066-0024P | 55 |
| 2431-87-16 | 71 | 2435-87-1 | 75 | 250-900-0630G | 58 | 251-066-0025G | 55 |
| 2431-87-3 | 71 | 2435-87-11 | 75 | 250-900-0630P | 58 | 251-066-0025P | 55 |
| 2431-87-6 | 71 | 2435-87-16 | 75 | 250-900-0631G | 58 | 251-066-0030G | 55 |
| 2431-88-1 | 71 | 2435-87-6 | 75 | 250-900-0631P | 58 | 251-066-0030P | 55 |
| 2431-88-11 | 71 | 2435-88-1 | 75 | 250-900-1160G | 58 | 251-066-0031G | 55 |
| 2431-88-16 | 71 | 2435-88-11 | 75 | 250-900-1160P | 58 | 251-066-0031P | 55 |
| 2431-88-6 | 71 | 2435-88-16 | 75 | 250-900-1161G | 58 | 251-066-0040G | 52 |
| 2431-89-1 | 71 | 2435-88-6 | 75 | 250-900-1161P | 58 | 251-066-0040P | 52 |
| 2431-89-11 | 71 | 2435-89-1 | 75 | 251-055-0022G | 55 | 251-066-0041G | 52 |
| 2431-89-16 | 71 | 2435-89-11 | 75 | 251-055-0022P | 55 | 251-066-0041P | 52 |
| 2431-89-6 | 71 | 2435-89-16 | 75 | 251-055-0023G | 55 | 251-075-0000G | 57 |
| 2431-90-1 | 71 | 2435-89-6 | 75 | 251-055-0023P | 55 | 251-075-0000P | 57 |
| 2431-90-11 | 71 | 2436-80-1 | 74 | 251-055-0024G | 55 | 251-075-0004G | 57 |
| 2431-90-16 | 71 | 2436-81-1 | 74 | 251-055-0024P | 55 | 251-075-0004P | 57 |
| 2431-90-6 | 71 | 2436-81-11 | 74 | 251-055-0025G | 55 | 251-575-0850G | 48 |

| Part Number | Page |
|---------------|------|
| 251-575-1410G | 48 |
| 251-975-0630G | 51 |
| 251-975-0630P | 51 |
| 251-975-0631G | 51 |
| 251-975-0631P | 51 |
| 251-975-1160G | 51 |
| 251-975-1160P | 51 |
| 251-975-1161G | 51 |
| 251-975-1161P | 51 |
| 252-500-0850G | 49 |
| 252-500-0850P | 49 |
| 252-500-1410G | 49 |
| 252-500-1410P | 49 |
| 252-900-0630G | 53 |
| 252-900-0630P | 53 |
| 252-900-0631G | 53 |
| 252-900-0631P | 53 |
| 252-900-1160G | 53 |
| 252-900-1160P | 53 |
| 252-900-1161G | 53 |
| 252-900-1161P | 53 |
| 253-055-0022G | 54 |
| 253-055-0022P | 54 |
| 253-055-0023G | 54 |
| 253-055-0023P | 54 |
| 253-055-0024G | 54 |
| 253-055-0024P | 54 |
| 253-055-0025G | 54 |
| 253-055-0025P | 55 |
| 253-060-0040G | 57 |
| 253-065-0000G | 54 |
| 253-065-0000P | 54 |
| 253-065-0022G | 55 |
| 253-065-0022P | 55 |
| 253-065-0023G | 55 |
| 253-065-0023P | 54 |
| 253-065-0024G | 54 |
| 253-065-0024P | 54 |
| 253-065-0025G | 54 |
| 253-065-0025P | 54 |
| 253-066-0022G | 54 |
| 253-066-0022P | 54 |
| 253-066-0023G | 54 |
| 253-066-0023P | 54 |
| 253-066-0024G | 54 |
| 253-066-0024P | 54 |
| 253-066-0025G | 54 |

| Part Number | Page |
|---------------|------|
| 253-066-0025P | 54 |
| 2555-3-32 | 100 |
| 350-500-0850H | 49 |
| 350-500-0858H | 49 |
| 350-500-1410H | 49 |
| 350-500-1411H | 49 |
| 350-500-1412H | 49 |
| 350-500-1418H | 49 |
| 350-900-0630H | 58 |
| 350-900-0630N | 58 |
| 350-900-0631H | 58 |
| 350-900-0631N | 58 |
| 350-900-1160H | 58 |
| 350-900-1160N | 58 |
| 350-900-1161H | 58 |
| 350-900-1161N | 58 |
| 351-055-0040H | 52 |
| 351-055-0040N | 52 |
| 351-055-0041H | 52 |
| 351-055-0041N | 52 |
| 351-060-0040H | 57 |
| 351-060-0046H | 57 |
| 351-060-7540H | 57 |
| 351-065-0040H | 52 |
| 351-065-0040N | 52 |
| 351-065-0041H | 52 |
| 351-065-0041N | 52 |
| 351-066-0040H | 52 |
| 351-066-0040N | 52 |
| 351-066-0041H | 52 |
| 351-066-0041N | 52 |
| 351-085-0030H | 57 |
| 351-085-0040H | 57 |
| 351-500-0850H | 48 |
| 351-500-1410H | 48 |
| 351-575-0850H | 48 |
| 351-575-1410H | 48 |
| 351-900-0630H | 51 |
| 351-900-0630N | 51 |
| 351-900-0631H | 51 |
| 351-900-0631N | 51 |
| 351-900-1160H | 51 |
| 351-900-1160N | 51 |
| 351-900-1161H | 51 |
| 351-900-1161N | 51 |
| 351-975-0630H | 51 |
| 351-975-0630N | 51 |

| Part Number | Page |
|---------------|------|
| 351-975-0631H | 51 |
| 351-975-0631N | 51 |
| 351-975-1160H | 51 |
| 351-975-1160N | 51 |
| 351-975-1161H | 51 |
| 351-975-1161N | 51 |
| 352-500-0850H | 49 |
| 352-500-1410H | 49 |
| 352-900-0630H | 53 |
| 352-900-0630N | 53 |
| 352-900-0631H | 53 |
| 352-900-0631N | 53 |
| 352-900-1160H | 53 |
| 352-900-1160N | 53 |
| 352-900-1161H | 53 |
| 352-900-1161N | 53 |
| 353-060-0040H | 57 |
| 353-060-0046H | 57 |
| 353-065-0000H | 54 |
| 353-065-0000N | 54 |
| 360-060-0040H | 19 |
| 360-065-0040H | 19 |
| 360-066-0040H | 19 |
| 360-500-0850H | 18 |
| 360-500-1410H | 18 |
| 360-574-0850H | 18 |
| 360-574-1410H | 18 |
| 360-900-0630H | 17 |
| 360-974-0630H | 17 |
| 361-060-0040H | 19 |
| 361-065-0040H | 19 |
| 361-066-0040H | 19 |
| 361-500-0850H | 18 |
| 361-500-1410H | 18 |
| 361-522-0850H | 18 |
| 361-522-1410H | 18 |
| 361-594-0850H | 18 |
| 361-594-1410H | 18 |
| 361-595-0850H | 18 |
| 361-595-1410H | 18 |
| 361-900-0630H | 17 |
| 361-922-0630H | 17 |
| 361-994-0630H | 17 |
| 361-995-0630H | 17 |
| 362-060-0040H | 19 |
| 362-074-6040H | 19 |
| 362-574-0850H | 18 |

| Part Number | Page |
|---------------|------|
| 362-574-1410H | 18 |
| 362-974-0630H | 17 |
| 363-060-0040H | 19 |
| 363-522-0850H | 18 |
| 363-522-1410H | 18 |
| 363-922-0630H | 17 |
| 450-060-0046H | 28 |
| 450-500-0470H | 27 |
| 450-500-0850H | 27 |
| 450-500-1410H | 27 |
| 450-900-0360H | 27 |
| 450-900-0630H | 27 |
| 450-900-0631H | 27 |
| 451-060-0046H | 28 |
| 451-061-0040H | 28 |
| 451-580-0470H | 27 |
| 451-580-0850H | 27 |
| 451-580-1410H | 27 |
| 451-980-0360H | 27 |
| 451-980-0630H | 27 |
| 451-980-0631H | 27 |
| 452-060-0046H | 28 |
| 452-500-0470H | 27 |
| 452-500-0850H | 27 |
| 452-500-1410H | 27 |
| 452-900-0360H | 27 |
| 452-900-0630H | 27 |
| 452-900-0631H | 27 |
| 453-040-0046H | 28 |
| 453-060-0041H | 28 |
| 453-060-0046H | 28 |
| 470-040-0040H | 31 |
| 470-500-0470H | 30 |
| 470-500-0850H | 30 |
| 470-900-0360H | 30 |
| 470-900-0361H | 30 |
| 470-900-0630H | 30 |
| 470-900-0631H | 30 |
| 470-900-1000H | 30 |
| 471-040-0040H | 31 |
| 471-086-0040H | 31 |
| 471-086-0040N | 31 |
| 471-500-0470H | 30 |
| 471-500-0850H | 30 |
| 471-900-0360H | 30 |
| 471-900-0361H | 30 |
| 471-900-0630H | 30 |

PART NUMBER INDEX

| Part Number | Page | Part Number | Page | Part Number | Page | Part Number | Page |
|---------------|------|---------------|------|-------------|------|-------------|------|
| 471-900-0631H | 30 | 511-880-0360H | 62 | 7520-10 | 123 | 758-26-5 | 11 |
| 471-900-1000H | 30 | 511-880-0360N | 62 | 7520-9 | 123 | 758-33-9 | 11 |
| 472-900-0360H | 30 | 511-880-0630H | 62 | 752-27-9 | 9 | 758-36-101 | 11 |
| 472-900-0361H | 30 | 511-880-0630N | 62 | 752-34-5 | 9 | 758-42-3 | 11 |
| 472-900-0470H | 30 | 511-880-0631H | 62 | 754-21-5 | 13 | 758-42-9 | 11 |
| 472-900-0630H | 30 | 511-880-0631N | 62 | 755-100-5 | 6 | 758-8-5 | 11 |
| 472-900-0631H | 30 | 511-980-0360H | 62 | 755-104-9 | 7 | 759-1 | 14 |
| 472-900-0850H | 30 | 511-980-0360N | 62 | 755-112-5 | 7 | 759-2 | 14 |
| 472-900-1000H | 30 | 511-980-0630H | 62 | 755-112-9 | 7 | 759-3 | 15 |
| 473-040-0040H | 31 | 511-980-0630N | 62 | 755-114-5 | 7 | 759-4 | 17 |
| 473-040-0040N | 31 | 511-980-0631H | 62 | 755-114-9 | 7 | 759-5 | 14 |
| 510-060-0040H | 65 | 511-980-0631N | 62 | 755-115-5 | 7 | 759-9 | 14 |
| 510-060-0040N | 65 | 512-060-0040H | 65 | 755-116-5 | 7 | 7675-2 | 125 |
| 510-060-0047H | 65 | 512-060-0040N | 65 | 755-117-5 | 7 | 7675-5 | 125 |
| 510-060-0047N | 65 | 512-600-0850H | 63 | 755-118-5 | 7 | 7676-2 | 125 |
| 510-077-0040H | 65 | 512-600-0850N | 63 | 755-119-5 | 7 | 7702-1 | 109 |
| 510-600-0850H | 63 | 512-600-1410H | 63 | 755-120-5 | 7 | 7702-10 | 110 |
| 510-600-0850N | 63 | 512-600-1410N | 63 | 755-121-5 | 7 | 7702-11 | 110 |
| 510-600-1410H | 63 | 512-900-0360H | 62 | 755-122-5 | 7 | 7702-12 | 110 |
| 510-600-1410N | 63 | 512-900-0360N | 62 | 755-127-9 | 7 | 7702-13 | 110 |
| 510-800-0360H | 62 | 512-900-0630N | 62 | 755-128-9 | 7 | 7702-14 | 109 |
| 510-800-0360N | 62 | 512-900-0631H | 62 | 755-129-9 | 7 | 7702-15 | 110 |
| 510-800-0630H | 62 | 512-900-0631N | 62 | 755-63-9 | 7 | 7702-17 | 110 |
| 510-800-0630N | 62 | 513-060-0040H | 65 | 755-74-5 | 6 | 7702-2 | 109 |
| 510-800-0631H | 62 | 513-060-0040N | 65 | 755-78-9 | 7 | 7702-3 | 109 |
| 510-800-0631N | 62 | 513-060-0080H | 65 | 755-79-9 | 7 | 7702-4 | 110 |
| 510-900-0360H | 62 | 513-060-0080N | 65 | 755-86-5 | 6 | 7702-5 | 110 |
| 510-900-0360N | 62 | 513-077-0040H | 65 | 755-93-9 | 7 | 7702-6 | 110 |
| 510-900-0630H | 62 | 611-1-9 | 69 | 756-10-9 | 8 | 7702-7 | 110 |
| 510-900-0630N | 62 | 615-11-9 | 76 | 756-12-5 | 8 | 7702-8 | 110 |
| 511-060-0040H | 65 | 7410-10 QD | 105 | 756-16-9 | 8 | 7702-9 | 110 |
| 511-060-0040N | 65 | 7410-14 | 105 | 756-18-9 | 8 | 7703-1 | 109 |
| 511-060-0047H | 65 | 7410-15 | 105 | 756-19-7 | 8 | 7703-2 | 109 |
| 511-060-0047N | 65 | 7410-16 | 105 | 756-21-7 | 8 | 7703-3 | 109 |
| 511-060-0048H | 65 | 7410-20 | 105 | 756-6-9 | 8 | 7703-4 | 110 |
| 511-060-0048N | 65 | 7475-21 | 125 | 756-9-5 | 8 | 7703-5 | 110 |
| 511-071-0000H | 65 | 7475-22 | 125 | 757-15-9 | 12 | 7703-6 | 109 |
| 511-071-0000N | 65 | 7510-1 | 105 | 757-29-5 | 12 | 7703-7 | 109 |
| 511-077-0040H | 65 | 7510-16 QD | 105 | 7575-13 | 126 | 7703-8 | 109 |
| 511-080-0000H | 65 | 7510-21 | 105 | 7575-15 | 126 | 7703-9 | 109 |
| 511-080-0000N | 65 | 7510-4 | 105 | 7575-18 | 126 | 7704-1 | 112 |
| 511-080-0001H | 65 | 7510-7 | 105 | 7575-21 | 126 | 7704-2 | 112 |
| 511-080-0001N | 65 | 751-10-9 | 10 | 7575-24 | 126 | 7704-3 | 112 |
| 511-082-0000H | 65 | 751-11-9 | 10 | 7575-26 | 126 | 7704-4 | 112 |
| 511-082-0000N | 65 | 751-20-9 | 10 | 7575-45 | 126 | 7704-5 | 112 |
| 511-680-0850H | 63 | 751-22-9 | 10 | 7575-46 | 126 | 7704-6 | 112 |
| 511-680-1410H | 63 | 751-26-9 | 10 | 7575-47 | 126 | 7704-7 | 112 |

| Part Number | Page |
|-------------|------|
| 7704-8 | 112 |
| 7704-9 | 112 |
| 7705-1 | 109 |
| 7705-2 | 109 |
| 7705-3 | 109 |
| 7705-4 | 109 |
| 7705-5 | 109 |
| 7705-6 | 109 |
| 7705-9 | 109 |
| 7706-1 | 109 |
| 7706-2 | 109 |
| 7707-1 | 112 |
| 7708-1 | 112 |
| 7708-11 | 112 |
| 7708-12 | 112 |
| 7708-2 | 112 |
| 7708-3 | 112 |
| 7708-4 | 112 |
| 7708-5 | 112 |
| 7708-6 | 112 |
| 7708-7 | 112 |
| 7708-8 | 112 |
| 7709-1 | 111 |
| 7709-2 | 111 |
| 7709-3 | 111 |
| 7709-5 | 111 |
| 7709-6 | 111 |
| 7709-8 | 111 |
| 7772-1 | 121 |
| 7772-2 | 121 |
| 7772-3 | 121 |
| 7772-4 | 121 |
| 7780-2 | 123 |
| 7780-3 | 123 |
| 7780-4 | 123 |
| 7780-5 | 123 |
| 7780-6 | 123 |
| 7780-7 | 123 |
| 7785-27 | 126 |
| 7785-29 | 126 |
| 7785-30 | 126 |
| 7785-31 | 126 |
| 7785-32 | 126 |
| 7785-4 | 126 |
| 7785-40 | 126 |
| 7785-41 | 126 |
| 7785-42 | 126 |

| Part Number | Page |
|-------------|------|
| 7785-5 | 126 |
| 7785-6 | 126 |
| 7785-7 | 126 |
| 7785-8 | 126 |
| 7790-2 | 121 |
| 7790-3 | 121 |
| 7790-4 | 121 |
| 7795-1 | 125 |
| 7795-11 | 125 |
| 7795-12 | 125 |
| 7795-13 | 125 |
| 7795-14 | 125 |
| 7795-15 | 125 |
| 7795-17 | 125 |
| 7795-27 | 125 |
| 7795-29 | 125 |
| 791-10-9 | 23 |
| 791-6-9 | 23 |
| 791-8-9 | 23 |
| 791-9-9 | 23 |
| 794-3-9 | 23 |
| 794-4-9 | 23 |
| 795-10-5 | 22 |
| 795-13-9 | 22 |
| 795-15-9 | 22 |
| 795-16-9 | 22 |
| 795-20-9 | 22 |
| 795-21-9 | 22 |
| 795-23-9 | 22 |
| 795-30-9 | 22 |
| 795-9-5 | 22 |
| 796-11-9 | 21 |
| 796-15-9 | 21 |
| 796-17-9 | 21 |
| 796-18-9 | 21 |
| 798-7-9 | 21 |
| 799-5 | 21 |
| 821-2-9 | 46 |
| 821-3-9 | 46 |
| 821-4-9 | 46 |
| 821-5-9 | 46 |
| 821-6-9 | 46 |
| 821-7-9 | 46 |
| 823-2-9 | 45 |
| 825-10-9 | 45 |
| 825-11-9 | 45 |
| 825-12-9 | 45 |

| Part Number | Page |
|-------------|------|
| 825-14-9 | 45 |
| 826-10-9 | 46 |
| 826-12-9 | 46 |
| 826-8-9 | 46 |
| 826-9-9 | 46 |
| 845-10-9 | 91 |
| 845-13-9 | 91 |
| 845-9-9 | 91 |
| 846-5-9 | 91 |
| 846-7-9 | 91 |
| 848-3-5 | 92 |
| 849-5-9 | 92 |
| 8600-2 | 119 |
| 8601-1 | 119 |
| 871-13 | 51 |
| 871-38-3 | 51 |
| 871-57-3 | 51 |
| 871-59-3 | 51 |
| 871-68-1 | 51 |
| 872-36-3 | 48 |
| 872-37-3 | 48 |
| 872-47-3 | 48 |
| 872-56-2 | 48 |
| 872-57-3 | 48 |
| 873-1-3 | 51 |
| 873-18 | 51 |
| 873-18-3 | 51 |
| 873-19-3 | 48 |
| 873-3-1 | 51 |
| 874-1 | 57 |
| 874-11-3 | 57 |
| 874-2-3 | 57 |
| 874-4 | 57 |
| 875-100-3 | 58 |
| 875-101-3 | 58 |
| 875-105-3 | 58 |
| 875-107-3 | 49 |
| 875-110-4 | 58 |
| 875-1-3 | 58 |
| 875-21-17 | 58 |
| 875-21-18 | 58 |
| 875-21-3 | 58 |
| 875-3-3 | 58 |
| 875-57-1 | 58 |
| 875-58-3 | 49 |
| 875-59-3 | 49 |
| 875-69-3 | 49 |

| Part Number | Page |
|---------------|------|
| 875-70-17 | 49 |
| 875-70-3 | 49 |
| 875-81-17 | 49 |
| 875-82-17 | 49 |
| 875-82-3 | 49 |
| 875-86-3 | 49 |
| 875-9 M09 | 58 |
| 875-91-3 | 58 |
| 875-92-3 | 58 |
| 875-9-3 | 58 |
| 876-49-3 | 49 |
| 876-60-3 | 49 |
| 876-61-17 | 49 |
| 876-62-17 | 49 |
| 876-62-3 | 49 |
| 876-64-3 | 53 |
| 876-72-3 | 53 |
| 877-114-4 | 57 |
| 877-120-5 | 55 |
| 877-86-1 | 57 |
| 877-87-1 | 57 |
| 877-92-1 | 57 |
| 877-93-1 | 57 |
| 877-94-1 | 57 |
| 877-95-1 | 57 |
| 878-2-3 | 48 |
| 879-1-3 | 55 |
| 879-1-9 | 55 |
| 879-2-1 | 55 |
| 879-2-3 | 55 |
| 879-3 | 55 |
| 879-3-3 | 55 |
| K-4944 | 78 |
| K-8845-012-** | 107 |
| K-8845-018-** | 107 |
| K-8845-024-** | 107 |
| K-8845-036-** | 107 |
| K-8845-048-** | 107 |
| K-8845-060-** | 107 |
| K-8845-072-** | 107 |
| K-8845-084-** | 107 |
| K-8845-096-** | 107 |
| K-8845-120-** | 107 |
| K-8846-012-** | 107 |
| K-8846-024-** | 107 |
| K-8846-036-** | 107 |
| K-8846-048-** | 107 |

PART NUMBER INDEX

| Part Number | Page |
|---------------|------|
| K-8846-060-** | 107 |
| K-8846-072-** | 107 |
| K-8846-096-** | 107 |
| K-8846-120-** | 107 |
| K-8846-144-** | 107 |
| K-8846-288-** | 107 |
| KA-11-07 | 68 |
| KA-19-101 | 68 |
| KA-19-102 | 68 |
| KA-19-110 | 69 |
| KA-19-142 | 68 |
| KA-19-143 | 69 |
| KA-19-146 | 68 |
| KA-19-151 | 68 |
| KA-19-152 | 68 |
| KA-19-153 | 68 |
| KA-19-155 | 69 |
| KA-19-156 | 69 |
| KA-19-157 | 69 |
| KA-19-171 | 68 |
| KA-19-172 | 68 |
| KA-19-176 | 67 |
| KA-19-181 | 67 |
| KA-19-19 | 68 |
| KA-19-195 M06 | 69 |
| KA-19-198 M06 | 69 |
| KA-19-213 M06 | 69 |
| KA-19-214 | 69 |
| KA-19-216 M06 | 69 |
| KA-19-25 | 69 |
| KA-19-42 | 68 |
| KA-19-51 | 69 |
| KA-19-60 | 68 |
| KA-19-83 | 69 |
| KA-39-100 M06 | 67 |
| KA-39-76 | 67 |
| KA-39-79 | 67 |
| KA-39-82 | 67 |
| KA-39-85 | 67 |
| KA-39-87 | 67 |
| KA-39-93 M07 | 69 |
| KA-51-18 | 73 |
| KA-51-19 | 73 |
| KA-59-103 | 77 |
| KA-59-138 | 72 |
| KA-59-146 | 73 |
| KA-59-167 | 76 |

| Part Number | Page |
|---------------|------|
| KA-59-18 | 73 |
| KA-59-185 | 76 |
| KA-59-185 MC7 | 76 |
| KA-59-186 | 72 |
| KA-59-188 | 76 |
| KA-59-189 | 72 |
| KA-59-208 | 72 |
| KA-59-22 | 73 |
| KA-59-220 | 77 |
| KA-59-230 | 77 |
| KA-59-231 | 77 |
| KA-59-232 | 77 |
| KA-59-235 | 72 |
| KA-59-236 | 72 |
| KA-59-237 | 72 |
| KA-59-251 | 76 |
| KA-59-260 | 76 |
| KA-59-263 | 77 |
| KA-59-267 | 73 |
| KA-59-277 | 76 |
| KA-59-279 | 77 |
| KA-59-281 | 72 |
| KA-59-287 | 77 |
| KA-59-289 | 73 |
| KA-59-29 | 73 |
| KA-59-290 | 77 |
| KA-59-291 | 77 |
| KA-59-292 | 77 |
| KA-59-295 | 72 |
| KA-59-296 | 72 |
| KA-59-297 | 72 |
| KA-59-304 | 72 |
| KA-59-318 | 72 |
| KA-59-324 | 74 |
| KA-59-343 | 73 |
| KA-59-348 | 73 |
| KA-59-353 M06 | 76 |
| KA-59-375 M07 | 76 |
| KA-59-391 M06 | 76 |
| KA-59-392 M06 | 76 |
| KA-59-406 M06 | 77 |
| KA-59-435 | 73 |
| KA-59-438 M06 | 76 |
| KA-59-439 M06 | 72 |
| KA-59-69 | 77 |
| KA-59-70 M06 | 72 |
| KA-59-72 | 72 |

| Part Number | Page |
|---------------|------|
| KA-59-85 M07 | 73 |
| KA-59-96 | 72 |
| KA-71-02 | 78 |
| KA-71-03 | 78 |
| KA-71-04 | 78 |
| KA-71-08 | 78 |
| KA-71-09 | 78 |
| KA-79-118 | 78 |
| KA-79-156 M06 | 78 |
| KA-79-157 M06 | 78 |
| KA-79-161 MC9 | 78 |
| KA-79-165 M06 | 78 |
| KA-79-28 | 78 |
| KA-79-39 | 78 |
| KA-79-56 | 78 |
| KA-79-59 | 78 |
| KA-81-01 | 80 |
| KA-81-02 | 80 |
| KA-81-03 | 80 |
| KA-81-04 | 80 |
| KA-81-04 M06 | 80 |
| KA-81-05 | 80 |
| KA-81-07 | 80 |
| KA-89-15 | 77 |
| KA-89-18 | 80 |
| KA-89-82 | 80 |
| KA-91-02 | 79 |
| KA-91-15 | 79 |
| KA-91-16 | 79 |
| KA-99-114 M06 | 79 |
| KA-99-125 M06 | 79 |
| KA-99-56 | 79 |
| KA-99-65 | 79 |
| KA-99-74 | 79 |
| KA-99-79 | 79 |
| KA-99-98 | 79 |
| KC-19-02 | 10 |
| KC-19-110 | 9 |
| KC-19-122 | 9 |
| KC-19-129 | 10 |
| KC-19-138 | 9 |
| KC-19-140 | 9 |
| KC-19-152 | 9 |
| KC-19-170 | 9 |
| KC-19-175 | 9 |
| KC-19-207 | 9 |
| KC-19-208 | 9 |

| Part Number | Page |
|---------------|------|
| KC-19-212 | 9 |
| KC-19-239 | 10 |
| KC-19-244 | 10 |
| KC-19-245 | 10 |
| KC-19-248 | 9 |
| KC-19-249 | 9 |
| KC-19-250 | 9 |
| KC-19-256 | 10 |
| KC-19-258 | 9 |
| KC-19-261 | 9 |
| KC-19-282 | 9 |
| KC-19-288 M06 | 10 |
| KC-19-293 M06 | 9 |
| KC-19-323 M06 | 9 |
| KC-19-328 M06 | 10 |
| KC-19-329 M06 | 10 |
| KC-19-50 | 9 |
| KC-19-54 | 9 |
| KC-19-93 | 9 |
| KC-19-94 | 10 |
| KC-39-03 | 11 |
| KC-39-103 | 10 |
| KC-39-105 | 10 |
| KC-39-106 | 10 |
| KC-39-134 M07 | 10 |
| KC-39-30 | 11 |
| KC-39-38 | 10 |
| KC-39-45 | 10 |
| KC-39-50 | 10 |
| KC-39-93 | 10 |
| KC-39-98 | 10 |
| KC-59-107 | 7 |
| KC-59-109 | 8 |
| KC-59-111 | 6 |
| KC-59-136 | 6 |
| KC-59-141 | 6 |
| KC-59-155 | 6 |
| KC-59-156 | 6 |
| KC-59-175 | 6 |
| KC-59-184 | 6 |
| KC-59-188 | 6 |
| KC-59-195 | 7 |
| KC-59-212 | 8 |
| KC-59-220 | 7 |
| KC-59-232 | 7 |
| KC-59-239 | 6 |
| KC-59-246 | 8 |

| Part Number | Page |
|---------------|------|
| KC-59-248 | 6 |
| KC-59-248 M06 | 6 |
| KC-59-261 | 8 |
| KC-59-267 | 7 |
| KC-59-270 | 8 |
| KC-59-280 | 7 |
| KC-59-284 | 6 |
| KC-59-287 | 8 |
| KC-59-288 | 6 |
| KC-59-358 | 6 |
| KC-59-383 | 7 |
| KC-59-408 | 8 |
| KC-59-418 | 8 |
| KC-59-419 | 8 |
| KC-59-420 | 8 |
| KC-59-444 | 8 |
| KC-59-446 | 7 |
| KC-59-447 | 8 |
| KC-59-482 | 7 |
| KC-59-485 | 7 |
| KC-59-533 | 8 |
| KC-59-544 | 6 |
| KC-59-545 | 6 |
| KC-59-548 | 6 |
| KC-59-577 M06 | 7 |
| KC-59-588 M06 | 6 |
| KC-59-61 | 6 |
| KC-59-89 | 6 |
| KC-59-95 | 7 |
| KC-79-07 | 12 |
| KC-79-07 M06 | 12 |
| KC-79-105 | 13 |
| KC-79-106 | 13 |
| KC-79-107 | 13 |
| KC-79-108 | 13 |
| KC-79-108 M06 | 13 |
| KC-79-109 | 12 |
| KC-79-110 | 13 |
| KC-79-111 | 13 |
| KC-79-125 | 12 |
| KC-79-131 | 13 |
| KC-79-150 | 13 |
| KC-79-155 | 13 |
| KC-79-168 | 12 |
| KC-79-179 | 13 |
| KC-79-197 | 13 |
| KC-79-200 | 13 |

| Part Number | Page |
|---------------|------|
| KC-79-214 | 13 |
| KC-79-215 | 12 |
| KC-79-237 M06 | 12 |
| KC-79-237 M07 | 12 |
| KC-79-260 M06 | 12 |
| KC-79-274 M06 | 12 |
| KC-79-302 M06 | 13 |
| KC-79-35 | 13 |
| KC-79-44 QD | 13 |
| KC-79-48 | 13 |
| KC-79-51 | 11 |
| KC-79-58 | 13 |
| KC-79-59 | 13 |
| KC-79-67 QD | 13 |
| KC-79-74 | 13 |
| KC-89-103 | 13 |
| KC-89-163 | 13 |
| KC-89-180 | 11 |
| KC-89-39 | 11 |
| KC-89-42 | 13 |
| KC-89-58 | 11 |
| KC-89-59 | 11 |
| KC-89-64 | 13 |
| KC-89-87 | 11 |
| KC-89-88 | 11 |
| KC-89-89 | 11 |
| KC-89-92 | 11 |
| KC-89-93 | 11 |
| KC-99-108 M06 | 15 |
| KC-99-20 | 15 |
| KC-99-30 | 14 |
| KC-99-31 | 15 |
| KC-99-32 | 14 |
| KC-99-35 | 15 |
| KC-99-37 | 15 |
| KC-99-38 | 14 |
| KC-99-40 | 14 |
| KC-99-52 | 15 |
| KC-99-53 | 15 |
| KC-99-54 | 14 |
| KC-99-56 | 14 |
| KC-99-95 M06 | 14 |
| KD-19-101 | 23 |
| KD-19-104 M06 | 23 |
| KD-19-105 M06 | 23 |
| KD-19-110 | 23 |
| KD-19-61 | 23 |

| Part Number | Page |
|---------------|------|
| KD-19-65 | 23 |
| KD-19-66 | 23 |
| KD-19-67 | 23 |
| KD-19-68 | 23 |
| KD-19-69 | 23 |
| KD-19-72 | 23 |
| KD-19-73 | 23 |
| KD-19-93 | 23 |
| KD-59-110 | 21 |
| KD-59-110 M07 | 21 |
| KD-59-119 | 22 |
| KD-59-125 | 22 |
| KD-59-126 | 21 |
| KD-59-129 | 21 |
| KD-59-130 | 22 |
| KD-59-132 | 22 |
| KD-59-133 | 22 |
| KD-59-134 | 21 |
| KD-59-135 | 22 |
| KD-59-161 | 22 |
| KD-59-164 | 22 |
| KD-59-180 M06 | 22 |
| KD-59-186 M06 | 22 |
| KD-59-187 M06 | 21 |
| KD-59-193 M06 | 21 |
| KD-59-201 M06 | 22 |
| KD-59-202 M06 | 21 |
| KD-59-26 | 21 |
| KD-59-47 | 21 |
| KD-59-63 | 22 |
| KD-59-84 | 21 |
| KD-79-13 | 23 |
| KD-79-14 | 23 |
| KD-79-19 | 23 |
| KD-89-08 | 21 |
| KG-59-34 M06 | 45 |
| KG-81-02 | 45 |
| KH-39-11 | 92 |
| KH-39-12 | 92 |
| KH-39-25 M06 | 92 |
| KH-59-05 | 91 |
| KH-59-24 | 91 |
| KH-59-26 | 91 |
| KH-59-63 | 91 |
| KH-59-64 | 91 |
| KH-59-65 | 91 |
| KH-59-66 | 91 |

| Part Number | Page |
|---------------|------|
| KH-59-72 | 91 |
| KH-59-78 | 91 |
| KH-59-84 | 91 |
| KH-79-15 | 92 |
| KH-99-10 | 92 |
| KN-19-110 | 34 |
| KN-19-114 | 33 |
| KN-19-115 | 35 |
| KN-19-118 | 35 |
| KN-19-145 | 34 |
| KN-19-148 | 35 |
| KN-19-149 | 34 |
| KN-19-150 | 34 |
| KN-19-151 | 34 |
| KN-19-162 | 35 |
| KN-19-186 M07 | 34 |
| KN-19-187 M07 | 33 |
| KN-19-195 M06 | 35 |
| KN-19-196 M06 | 34 |
| KN-19-198 M06 | 35 |
| KN-19-199 M06 | 35 |
| KN-19-205 M06 | 35 |
| KN-19-208 M06 | 35 |
| KN-19-42 | 33 |
| KN-39-102 | 33 |
| KN-39-114 M06 | 33 |
| KN-39-52 | 33 |
| KN-39-68 | 33 |
| KN-39-72 | 33 |
| KN-39-75 | 33 |
| KN-39-83 | 33 |
| KN-39-86 | 33 |
| KN-39-92 | 33 |
| KN-39-93 | 33 |
| KN-39-97 | 33 |
| KN-59-06 | 36 |
| KN-59-104 | 38 |
| KN-59-118 | 38 |
| KN-59-122 | 38 |
| KN-59-132 | 38 |
| KN-59-148 | 37 |
| KN-59-158 | 37 |
| KN-59-160 | 38 |
| KN-59-173 | 36 |
| KN-59-176 | 36 |
| KN-59-183 | 37 |
| KN-59-185 | 38 |

PART NUMBER INDEX

| Part Number | Page |
|---------------|------|
| KN-59-201 | 38 |
| KN-59-202 | 38 |
| KN-59-220 | 38 |
| KN-59-220 M07 | 38 |
| KN-59-226 | 36 |
| KN-59-239 | 38 |
| KN-59-242 | 38 |
| KN-59-242 M06 | 38 |
| KN-59-243 | 37 |
| KN-59-244 | 37 |
| KN-59-245 | 37 |
| KN-59-247 | 38 |
| KN-59-260 | 38 |
| KN-59-261 | 37 |
| KN-59-263 | 37 |
| KN-59-263 M07 | 37 |
| KN-59-264 | 37 |
| KN-59-266 | 38 |
| KN-59-271 | 36 |
| KN-59-294 | 36 |
| KN-59-295 | 36 |
| KN-59-296 | 36 |
| KN-59-298 | 36 |
| KN-59-313 M06 | 37 |
| KN-59-329 M06 | 38 |
| KN-59-330 M06 | 38 |
| KN-59-332 M06 | 37 |
| KN-59-344 MAF | 36 |
| KN-59-361 M06 | 38 |
| KN-59-48 | 36 |
| KN-59-53 | 36 |
| KN-59-57 | 36 |
| KN-59-68 | 38 |
| KN-59-92 | 37 |
| KN-79-45 M06 | 39 |
| KN-79-69 | 39 |
| KN-79-70 | 39 |
| KN-89-05 | 41 |
| KN-89-12 | 41 |
| KN-89-13 | 41 |
| KN-89-14 | 41 |
| KN-89-30 | 41 |
| KN-89-31 | 41 |
| KN-89-87 M07 | 41 |
| KN-99-102 M06 | 40 |
| KN-99-14 | 40 |
| KN-99-30 | 40 |

| Part Number | Page |
|-----------------|------|
| KN-99-34 | 40 |
| KN-99-34 M06 | 40 |
| KN-99-44 | 40 |
| KN-99-50 | 40 |
| KN-99-58 | 40 |
| KP-8000-060 | 112 |
| KP-8000-061 | 112 |
| KP-8000-062 | 112 |
| KP-8000-063 | 112 |
| KP-8012-767-400 | 109 |
| KP-8021-767-400 | 110 |
| KTH-1000 | 130 |
| KTH-5000 | 130 |
| KTM-5000 | 130 |
| KTS-8-1 | 130 |
| KTS-8-2 | 130 |
| KTW-13 | 130 |
| KV-59-04 | 94 |
| KV-59-23 | 94 |
| KV-59-26 | 94 |
| KV-59-37 | 94 |
| KV-59-56 | 94 |
| KV-59-70 | 94 |
| KV-79-11 | 95 |
| KV-79-12 | 95 |
| KV-79-15 | 95 |
| KV-79-21 | 95 |
| KV-99-45 | 94 |
| KV-99-46 | 94 |
| UG-1094 /U | 13 |
| UG-1095 B/U | 34 |
| UG-1104 A/U | 11 |
| UG-1186 /U | 33 |
| UG-160 C/U | 33 |
| UG-1873 /U | 13 |
| UG-27 C/U | 40 |
| UG-27 D/U | 40 |
| UG-30 E/U | 40 |
| UG-447 /U | 12 |
| UG-496 /U | 92 |
| UG-535 /U | 12 |
| UG-536 A/U | 36 |
| UG-536 B/U | 36 |
| UG-536 C/U | 36 |
| UG-556 B/U | 33 |
| UG-57 B/U | 40 |
| UG-59 E/U | 91 |

| Part Number | Page |
|-------------|------|
| UG-594 B/U | 36 |
| UG-943 B/U | 22 |
| UG-997 A/U | 39 |



ISO 9001:2000 & AS9100
FM 46160

All Winchester Electronics KINGS® brand products are manufactured under ISO 9001-2000 and AS9100 registered quality management systems.



All Winchester Electronics KINGS® brand products are in full compliance with the European Union Directive 2002/95/EC (RoHS). We are committed to continuous improvement, and are actively working to ensure restricted substances are removed from our products, or below RoHS specified limits.



Winchester Electronics KINGS® brand RF connector and patch plug products are Network Equipment – Building Systems (NEBS) Level III Certified.

While the information in this publication is believed to be accurate and reliable, all data presented is subject to change without notice. Winchester Electronics Corporation disclaims responsibility for any damages resulting from application or any incompleteness or inaccuracies in the information presented. Consult factory for specific information on the latest design specifications.

Registered Trademarks of Winchester Electronics Corporation -
TR-4®, TR-5®, K-GRIP®, K-GRIP JR®, WEATHERPROOF K-GRIP JR®, PRE-ASSEMBLED K-GRIP®, TAPER GRIP®, SPEED-GRIP®, TRI-LOC®, ROTO-STRIP®, the KINGS® SYMBOL, and Connecting Innovation to Application®
KINGS® and the KINGS® DESIGN are trademarks of Winchester Electronics Corporation.