

Female Style 1/2 Q



Series 8477 – 2 rows (2 x 16) Inverted



Contact Design and Termination Length	Number of Contacts	Loading Description	Part Number Performance classes according to DIN 41612	
			II	I
0.6 x 0.6 mm Post Profile 3.0 mm (Y) Right Angled	64	a + b fully loaded	20 8477 032 002 025	20 8477 032 002 049
	32	a + b all even loading	20 8477 032 002 031	20 8477 032 002 055
	32	a loading only	20 8477 032 002 027	20 8477 032 002 051
0.6 x 0.6 mm Post Profile 11.43 mm (Y) Right Angled	32	a + b fully loaded	20 8477 032 008 025	20 8477 032 008 049
	16	a + b all even loading	20 8477 032 008 031	20 8477 032 008 055
0.6 x 0.6 mm Post Profile 4.5 mm (Y) Right Angled	16	a loading only	20 8477 032 008 027	20 8477 032 008 051
	32	a + b fully loaded	20 8477 032 012 025	20 8477 032 012 049
0.6 x 0.6 mm Post Profile 4.5 mm (Y) Right Angled	16	a + b all even loading	20 8477 032 012 031	20 8477 032 012 055
	16	a loading only	20 8477 032 012 027	20 8477 032 012 051

NB: Prefix Variations Available: 22, 26 & 27, please refer to Page 10.
Additional Plating & Loading Variations: Please contact your local AVX sales office or distributor.

LOADING DESCRIPTION



32 contacts, rows a + b fully loaded



16 contacts, rows a + b even loading



16 contacts, row a loading only

DIMENSIONS

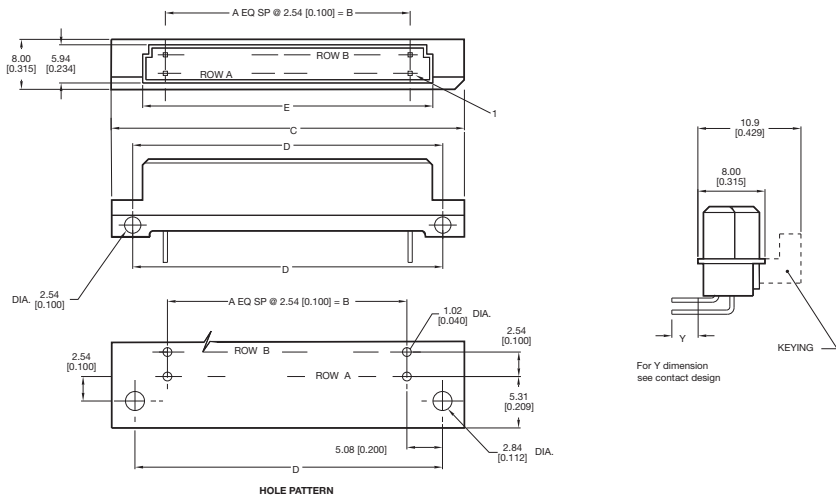

Unit: millimeters (inches)

No. Contact Positions	Contact Rows	A	B	C	D	E
32	2 (2 x 16)	15	38.10 (1.500)	53.90 (2.122)	48.26 (1.900)	44.30 (1.744)

Male Style 1/2 Q



Series 8477 – 2 rows (2 x 16) Inverted

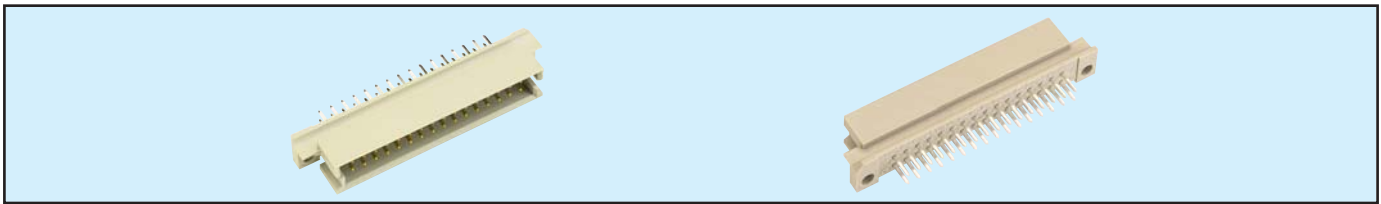

Contact Design and Termination Length	Number of Contacts	Loading Description	Part Number		
			Performance classes according to DIN 41612		
			II	I	
2.9 mm (Y) Straight		32	a + b fully loaded	10 8477 032 001 025	10 8477 032 001 049
		16	a + b even loading	10 8477 032 001 031	10 8477 032 001 055
		16	a loading only	10 8477 032 001 027	10 8477 032 001 051
		30 + 2	fully loaded + ground	10 8477 032 101 025	10 8477 032 101 049
4.5 mm (Y) Straight		32	a + b fully loaded	10 8477 032 002 025	10 8477 032 002 049
		16	a + b even loading	10 8477 032 002 031	10 8477 032 002 055
		16	a loading only	10 8477 032 002 027	10 8477 032 002 051
		30 + 2	fully loaded + ground	10 8477 032 102 025	10 8477 032 102 049
9.5 mm (Y) Straight		32	a + b fully loaded	10 8477 032 005 025	10 8477 032 005 049
		16	a + b even loading	10 8477 032 005 031	10 8477 032 005 055
		16	a loading only	10 8477 032 005 027	10 8477 032 005 051
13.0 mm (Y) Straight		32	a + b fully loaded	10 8477 032 006 025	10 8477 032 006 049
		16	a + b even loading	10 8477 032 006 031	10 8477 032 006 055
		16	a loading only	10 8477 032 006 027	10 8477 032 006 051
14.9 mm (Y) Straight		32	a + b fully loaded	10 8477 032 007 025	10 8477 032 007 049
		16	a + b even loading	10 8477 032 007 031	10 8477 032 007 055
		16	a loading only	10 8477 032 007 027	10 8477 032 007 051

NB: Alternative Prefix Variations Available: 12, 14, 15, 16 & 17, please refer to Page 10.

Additional Plating & Loading Variations: Please contact your local AVX sales office or distributor.

LOADING DESCRIPTION

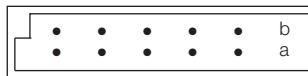

32 contacts, rows a + b fully loaded

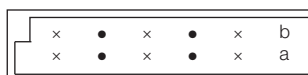

16 contacts, rows a + b even loading

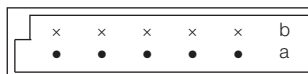

16 contacts, row a loading only

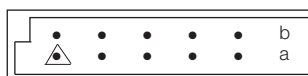

30 + 2 contacts, fully loaded with ground in A1 & A16

△ denotes ground pin

DIMENSIONS

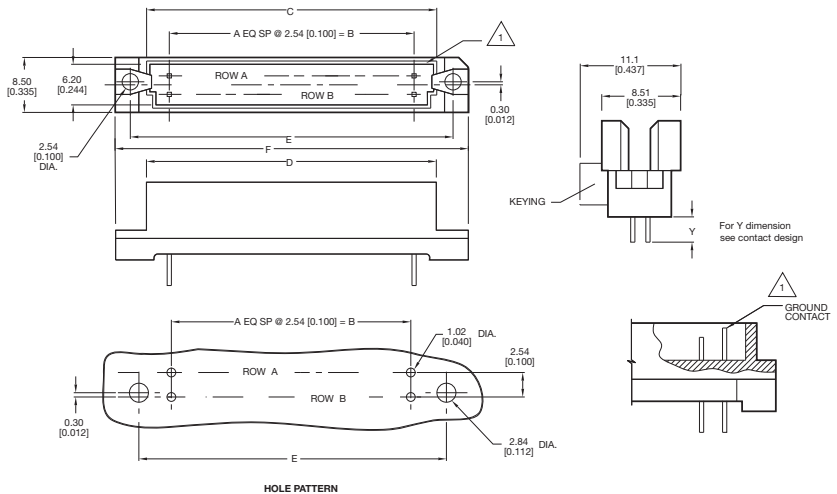

Unit: millimeters (inches)

No. Contact Positions	Contact Rows	A	B	C	D	E	F
32	2 (2 x 16)	15	38.10 (1.500)	44.70 (1.760)	47.29 (1.862)	49.99 (1.968)	54.91 (2.162)

Female Style Q



Series 8477 – 2 rows (2 x 32) Inverted

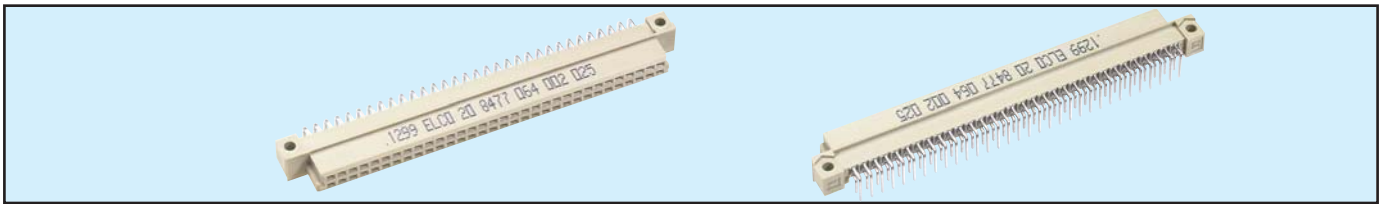

Contact Design and Termination Length	Number of Contacts	Loading Description	Part Number Performance classes according to DIN 41612	
			II	I
0.6 x 0.6 mm Post Profile 3.0 mm (Y) Right Angled	64	a + b fully loaded	20 8477 064 002 025	20 8477 064 002 049
	32	a + b all even loading	20 8477 064 002 031	20 8477 064 002 055
	32	a loading only	20 8477 064 002 027	20 8477 064 002 051
0.6 x 0.6 mm Post Profile 11.43 mm (Y) Right Angled	64	a + b fully loaded	20 8477 064 008 025	20 8477 064 008 049
	32	a + b all even loading	20 8477 064 008 031	20 8477 064 008 055
	32	a loading only	20 8477 064 008 027	20 8477 064 008 051
0.6 x 0.6 mm Post Profile 4.5 mm (Y) Right Angled	64	a + b fully loaded	20 8477 064 012 025	20 8477 064 012 049
	32	a + b all even loading	20 8477 064 012 031	20 8477 064 012 055
	32	a loading only	20 8477 064 012 027	20 8477 064 012 051

NB: Alternative Prefix Variations Available: 22, 26 & 27, please refer to Page 10.
Additional Plating & Loading Variations: Please contact your local AVX sales office or distributor.

LOADING DESCRIPTION



64 contacts, rows a + b fully loaded



32 contacts, rows a + b even loading



32 contacts row a loading only

DIMENSIONS

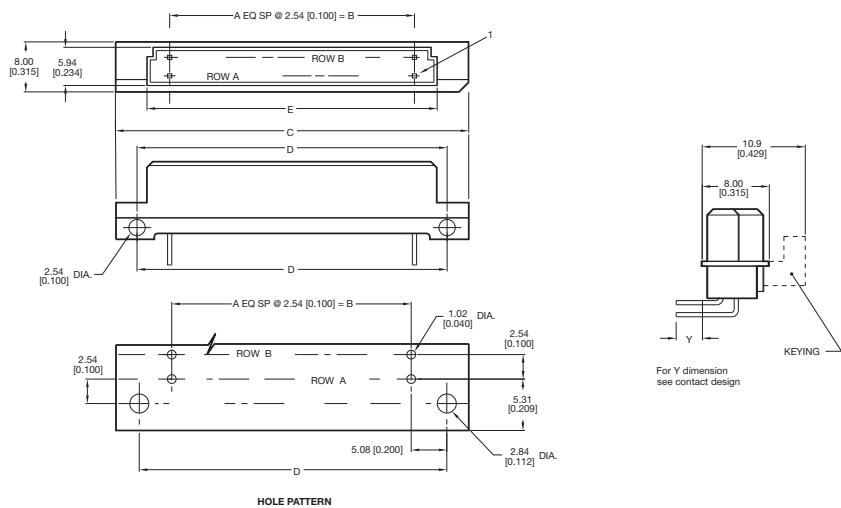

Unit: millimeters (inches)





No. Contact Positions	Contact Rows	A	B	C	D	E
64	2 (2 x 32)	31	78.74 (3.100)	93.90 (3.697)	88.90 (3.500)	84.91 (3.343)

Male Style Q

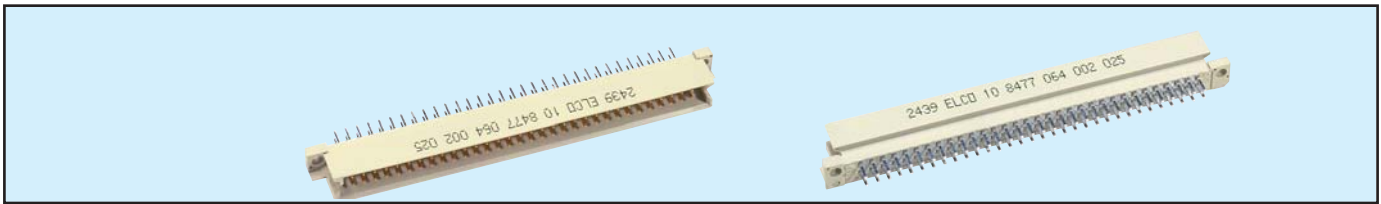

Series 8477 – 2 rows (2 x 32) Inverted



Contact Design and Termination Length	Number of Contacts	Loading Description	Part Number Performance classes according to DIN 41612	
			II	I
2.9 mm (Y) Straight 	64	a + b fully loaded	10 8477 064 001 025	10 8477 064 001 049
	32	a + b even loading	10 8477 064 001 031	10 8477 064 001 055
	32	a loading only	10 8477 064 001 027	10 8477 064 001 051
	62 + 2	fully loaded + ground	10 8477 064 101 025	10 8477 064 101 049
4.5 mm (Y) Straight 	64	a + b fully loaded	10 8477 064 002 025	10 8477 064 002 049
	32	a + b even loading	10 8477 064 002 031	10 8477 064 002 055
	32	a loading only	10 8477 064 002 027	10 8477 064 002 051
	62 + 2	fully loaded + ground	10 8477 064 102 025	10 8477 064 102 049
9.5 mm (Y) Straight 	64	a + b fully loaded	10 8477 064 005 025	10 8477 064 005 049
	32	a + b even loading	10 8477 064 005 031	10 8477 064 005 055
	32	a loading only	10 8477 064 005 027	10 8477 064 005 051
13.0 mm (Y) Straight 	64	a + b fully loaded	10 8477 064 006 025	10 8477 064 006 049
	32	a + b even loading	10 8477 064 006 031	10 8477 064 006 055
	32	a loading only	10 8477 064 006 027	10 8477 064 006 051
14.9 mm (Y) Straight 	64	a + b fully loaded	10 8477 064 007 025	10 8477 064 007 049
	32	a + b even loading	10 8477 064 007 031	10 8477 064 007 055
	32	a loading only	10 8477 064 007 027	10 8477 064 007 051

NB: Alternative Prefix Variations Available: 12, 14, 15, 16 & 17, please refer to Page 10.
Additional Plating & Loading Variations: Please contact your local AVX sales office or distributor.

LOADING DESCRIPTION

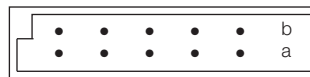

64 contacts, rows a + b fully loaded



32 contacts, rows a + b even loading

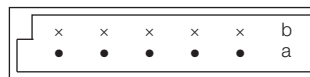

32 contacts, row a loading only

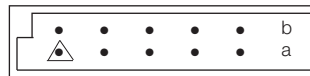

62 + 2 contacts, fully loaded with ground in A1 & A32

△ denotes ground pin

DIMENSIONS

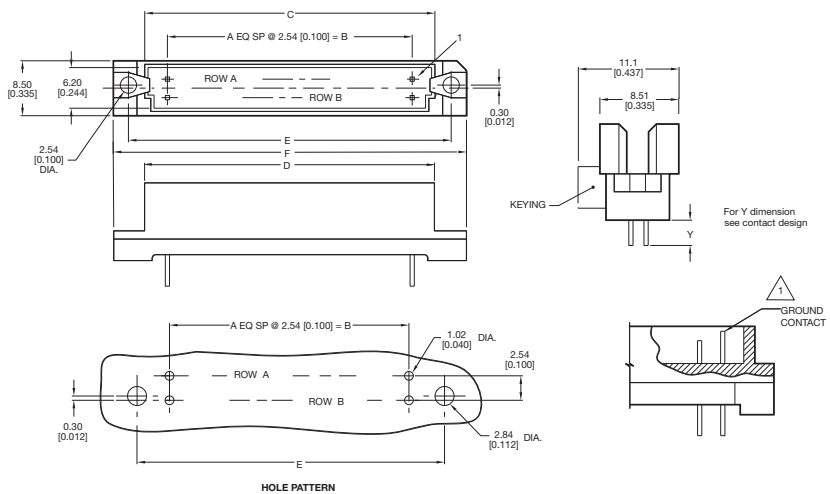

Unit: millimeters (inches)

No. Contact Positions	Contact Rows	A	B	C	D	E	F
64	2 (2 x 32)	31	78.74 (3.100)	85.29 (3.358)	87.91 (3.461)	90.0 (3.543)	94.89 (3.736)

Male Style 1/3 R



Series 8477 – 3 rows (3 x 10) Inverted

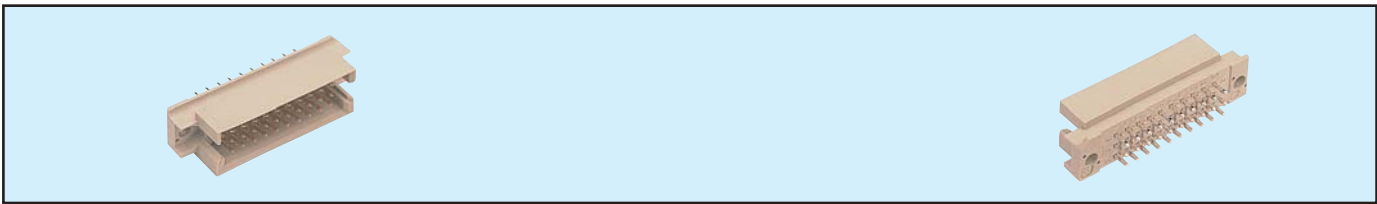

Contact Design and Termination Length	Number of Contacts	Loading Description	Part Number Performance classes according to DIN 41612	
			II	I
2.9 mm (Y) Straight	30	a + b + c fully loaded	10 8477 030 001 025	10 8477 030 001 049
	20	a + c fully loaded	10 8477 030 001 026	10 8477 030 001 050
	10	a + c even loading	10 8477 030 001 033	10 8477 030 001 057
	10	a loading only	10 8477 030 001 027	10 8477 030 001 051
	28 + 2	fully loaded + ground	10 8477 030 101 025	10 8477 030 101 049
4.5 mm (Y) Straight	30	a + b + c fully loaded	10 8477 030 002 025	10 8477 030 002 049
	20	a + c fully loaded	10 8477 030 002 026	10 8477 030 002 050
	10	a + c even loading	10 8477 030 002 033	10 8477 030 002 057
	10	a loading only	10 8477 030 002 027	10 8477 030 002 051
	28 + 2	fully loaded + ground	10 8477 030 102 025	10 8477 030 102 049
9.5 mm (Y) Straight	30	a + b + c fully loaded	10 8477 030 005 025	10 8477 030 005 049
	20	a + c fully loaded	10 8477 030 005 026	10 8477 030 005 050
	10	a + c even loading	10 8477 030 005 033	10 8477 030 005 057
	10	a loading only	10 8477 030 005 027	10 8477 030 005 051
	28 + 2	fully loaded + ground	10 8477 030 106 025	10 8477 030 106 049
13.0 mm (Y) Straight	30	a + b + c fully loaded	10 8477 030 006 025	10 8477 030 006 049
	20	a + c fully loaded	10 8477 030 006 026	10 8477 030 006 050
	10	a + c even loading	10 8477 030 006 033	10 8477 030 006 057
	10	a loading only	10 8477 030 006 027	10 8477 030 006 051
	28 + 2	fully loaded + ground	10 8477 030 106 025	10 8477 030 106 049
14.9 mm (Y) Straight	96	a + b + c fully loaded	10 8477 030 007 025	10 8477 030 007 049
	64	a + c fully loaded	10 8477 030 007 026	10 8477 030 007 050
	32	a + c even loading	10 8477 030 007 033	10 8477 030 007 057
	32	a loading only	10 8477 030 007 027	10 8477 030 007 051

NB: Alternative Prefix Variations Available: 12, 14, 15, 16 & 17, please refer to Page 10.
Additional Plating & Loading Variations: Please contact your local AVX sales office or distributor.

LOADING DESCRIPTION

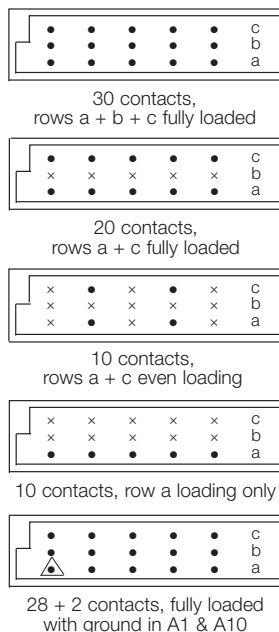

△ denotes ground pin

DIMENSIONS

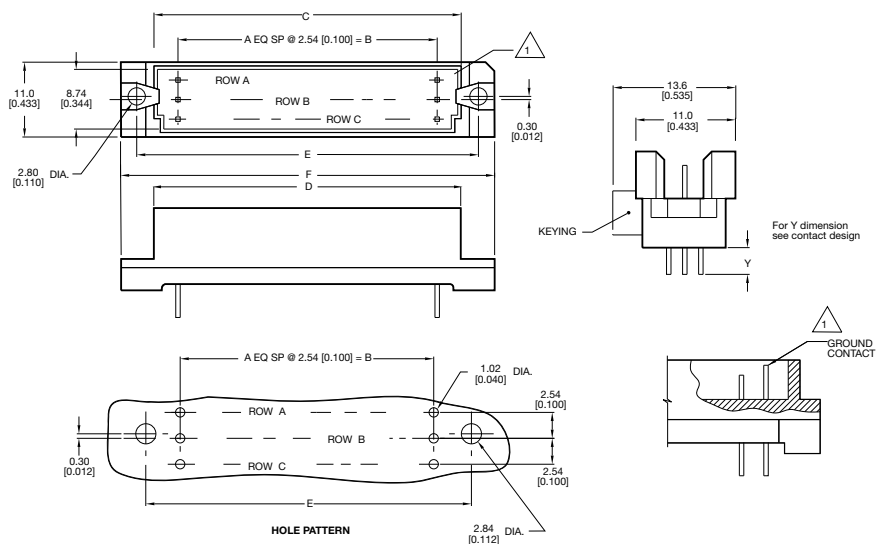

Unit: millimeters (inches)

No. Contact Positions	Contact Rows	A	B	C	D	E	F
30	3 (3 x 10)	9	22.86 (0.900)	29.44 (1.159)	32.12 (1.265)	34.76 (1.368)	39.76 (1.565)

Female Style 1/2 R



Series 8477 – 3 rows (3 x 16) Inverted



Contact Design and Termination Length	Number of Contacts	Loading Description	Part Number Performance classes according to DIN 41612	
			II	I
3.0 mm (Y) 0.6 x 0.6 mm Right Angled	48	a + b + c fully loaded	20 8477 048 002 025	20 8477 048 002 049
	32	a + c fully loaded	20 8477 048 002 026	20 8477 048 002 050
	16	a + c even loading	20 8477 048 002 033	20 8477 048 002 057
	16	a loading only	20 8477 048 002 027	20 8477 048 002 051
0.6 x 0.6 mm Post Profile 11.43 mm (Y) Right Angled	48	a + b + c fully loaded	20 8477 048 008 025	20 8477 048 008 049
	32	a + c fully loaded	20 8477 048 008 026	20 8477 048 008 050
	16	a + c even loading	20 8477 048 008 033	20 8477 048 008 057
	16	a loading only	20 8477 048 008 027	20 8477 048 008 051
0.6 x 0.6 mm Post Profile 4.5 mm (Y) Right Angled	48	a + b + c fully loaded	20 8477 048 012 025	20 8477 048 012 049
	32	a + c fully loaded	20 8477 048 012 026	20 8477 048 012 050
	16	a + c even loading	20 8477 048 012 033	20 8477 048 012 057
	16	a loading only	20 8477 048 012 027	20 8477 048 012 051

NB: Alternative Prefix Variations Available: 26, please refer to Page 10.

Additional Plating & Loading Variations: Please contact your local AVX sales office or distributor.

LOADING DESCRIPTION

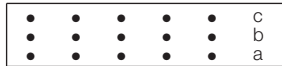

48 contacts, rows a + b + c fully loaded

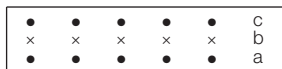

32 contacts, rows a + c fully loaded



16 contacts, rows a + c even loading



16 contacts, row a loading only

DIMENSIONS

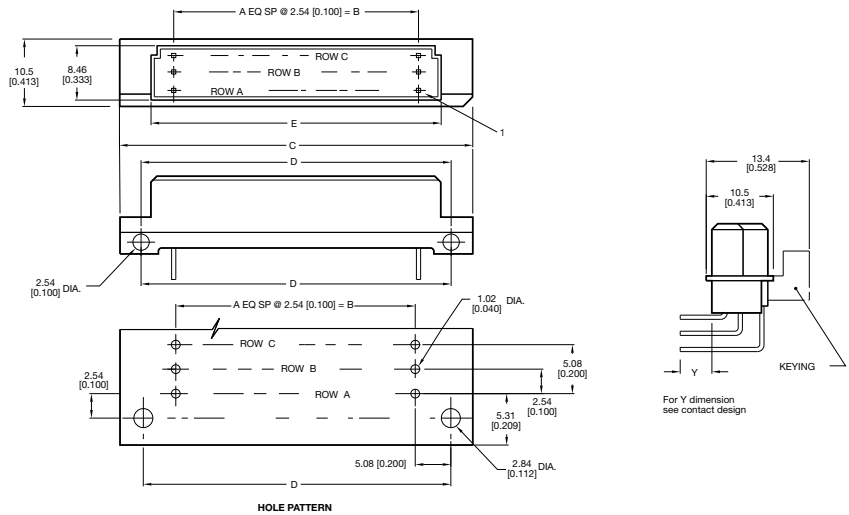

Unit: millimeters (inches)

No. Contact Positions	Contact Rows	A	B	C	D	E
48	3 (3 x 16)	15	38.10 (1.500)	53.90 (2.122)	48.26 (1.900)	44.30 (1.744)

Male Style 1/2 R



Series 8477 – 3 rows (3 x 16) Inverted

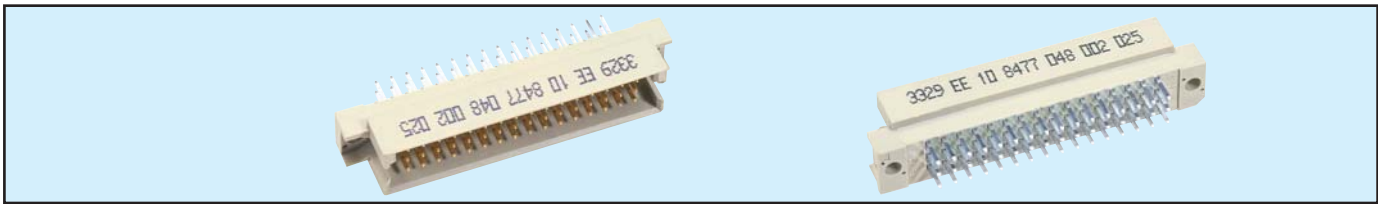

Contact Design and Termination Length	Number of Contacts	Loading Description	Part Number	
			Performance classes according to DIN 41612	
			II	I
2.9 mm (Y) Straight	48	a + b + c fully loaded	10 8477 048 001 025	10 8477 048 001 049
	32	a + c fully loaded	10 8477 048 001 026	10 8477 048 001 050
	16	a + c even loading	10 8477 048 001 033	10 8477 048 001 057
	16	a loading only	10 8477 048 001 027	10 8477 048 001 051
	46 + 2	fully loaded + ground	10 8477 048 101 025	10 8477 048 101 049
4.5 mm (Y) Straight	48	a + b + c fully loaded	10 8477 048 002 025	10 8477 048 002 049
	32	a + c fully loaded	10 8477 048 002 026	10 8477 048 002 050
	16	a + c even loading	10 8477 048 002 033	10 8477 048 002 057
	16	a loading only	10 8477 048 002 027	10 8477 048 002 051
	46 + 2	fully loaded + ground	10 8477 048 102 025	10 8477 048 102 049
9.5 mm (Y) Straight	48	a + b + c fully loaded	10 8477 048 005 025	10 8477 048 005 049
	32	a + c fully loaded	10 8477 048 005 026	10 8477 048 005 050
	16	a + c even loading	10 8477 048 005 033	10 8477 048 005 057
	16	a loading only	10 8477 048 005 027	10 8477 048 005 051
13.0 mm (Y) Straight	48	a + b + c fully loaded	10 8477 048 006 025	10 8477 048 006 049
	32	a + c fully loaded	10 8477 048 006 026	10 8477 048 006 050
	16	a + c even loading	10 8477 048 006 033	10 8477 048 006 057
	16	a loading only	10 8477 048 006 027	10 8477 048 006 051
	46 + 2	fully loaded + ground	10 8477 048 106 025	10 8477 048 106 049
14.9 mm (Y) Straight	48	a + b + c fully loaded	10 8477 048 007 025	10 8477 048 007 049
	32	a + c fully loaded	10 8477 048 007 026	10 8477 048 007 050
	16	a + c even loading	10 8477 048 007 033	10 8477 048 007 057
	16	a loading only	10 8477 048 007 027	10 8477 048 007 051

NB: Alternative Prefix Variations Available: 12, 14, 15, 16 & 17, please refer to Page 10.

Additional Plating & Loading Variations: Please contact your local AVX sales office or distributor.

LOADING DESCRIPTION

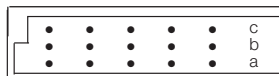

48 contacts,
rows a + b + c fully loaded

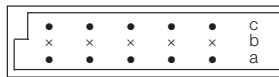

32 contacts,
rows a + c fully loaded

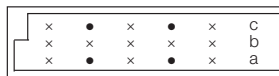

16 contacts,
rows a + c even loading

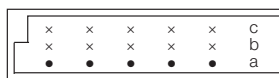

16 contacts, row a loading only

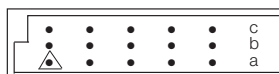

46 + 2 contacts, fully loaded
with ground in A1 & A16

△ denotes ground pin

DIMENSIONS

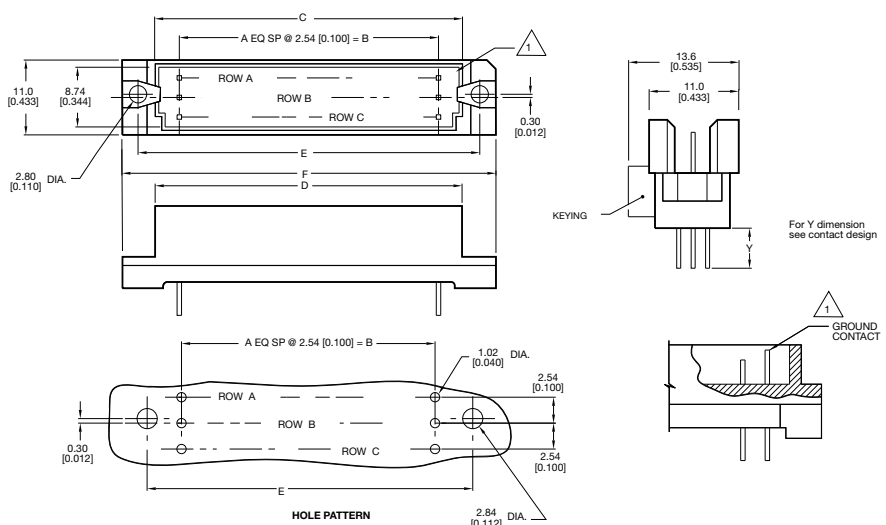

Unit: millimeters (inches)

No. Contact Positions	Contact Rows	A	B	C	D	E	F
48	3 (3 x 16)	15	38.10 (1.500)	44.70 (1.760)	47.29 (1.862)	49.99 (1.968)	54.91 (2.162)

Female Style R



Series 8477 – 3 rows (3 x 32) Inverted

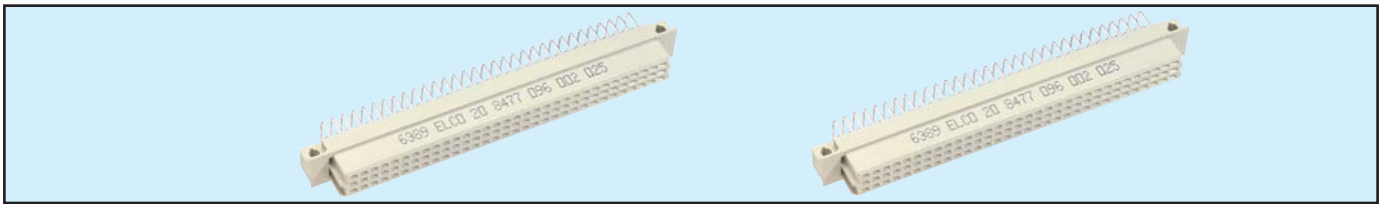

Contact Design and Termination Length	Number of Contacts	Loading Description	Part Number	
			Performance classes according to DIN 41612	
			II	I
3.0 mm (Y) 0.6 x 0.6 mm Right Angled	96	a + b + c fully loaded	20 8477 096 002 025	20 8477 096 002 049
	64	a + c fully loaded	20 8477 096 002 026	20 8477 096 002 050
	32	a + c even loading	20 8477 096 002 033	20 8477 096 002 057
	32	a loading only	20 8477 096 002 027	20 8477 096 002 051
0.6 x 0.6 mm 11.43 mm (Y) Right Angled	96	a + b + c fully loaded	20 8477 096 008 025	20 8477 096 008 049
	64	a + c fully loaded	20 8477 096 008 026	20 8477 096 008 050
	32	a + c even loading	20 8477 096 008 033	20 8477 096 008 057
	32	a loading only	20 8477 096 008 027	20 8477 096 008 051
0.6 x 0.6 mm 4.5 mm (Y) Right Angled	96	a + b + c fully loaded	20 8477 096 012 025	20 8477 096 012 049
	64	a + c fully loaded	20 8477 096 012 026	20 8477 096 012 050
	32	a + c even loading	20 8477 096 012 033	20 8477 096 012 057
	32	a loading only	20 8477 096 012 027	20 8477 096 012 051

NB: Alternative Prefix Variations Available: 26, please refer to Page 10.

Additional Plating & Loading Variations: Please contact your local AVX sales office or distributor.

LOADING DESCRIPTION



96 contacts, rows a + b + c fully loaded

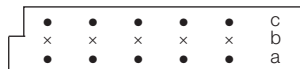

64 contacts, rows a + c fully loaded



32 contacts, rows a + c even loading

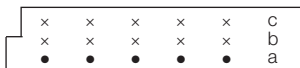

32 contacts, row a loading only

DIMENSIONS

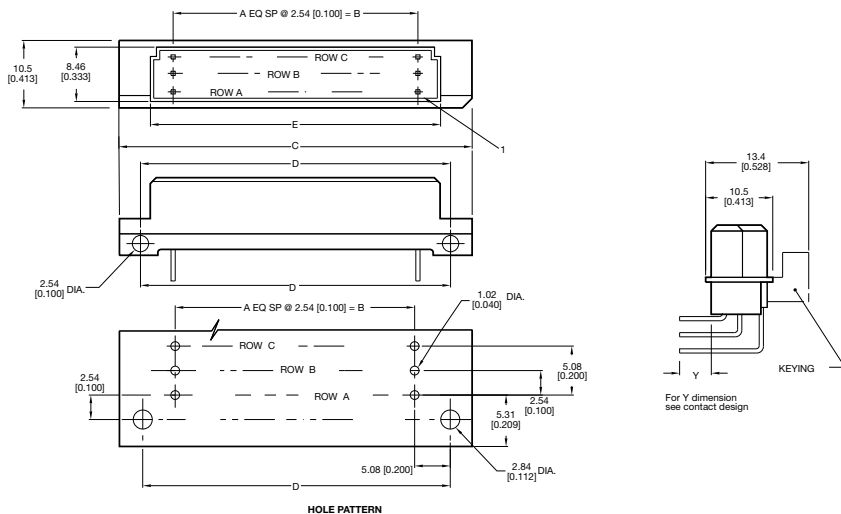

Unit: millimeters (inches)

No. Contact Positions	Contact Rows	A	B	C	D	E
96	3 (3 x 32)	31	78.74 (3.100)	93.90 (3.367)	88.90 (3.500)	84.91 (3.343)

Male Style R

Series 8477 – 3 rows (3 x 32) Inverted

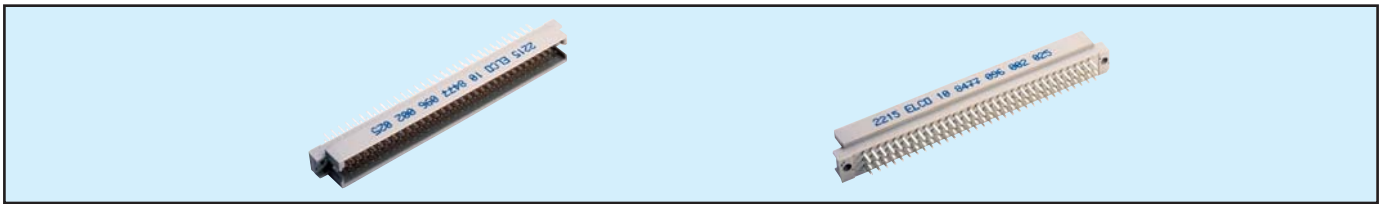

Contact Design and Termination Length	Number of Contacts	Loading Description	Part Number Performance classes according to DIN 41612	
			II	I
2.9 mm (Y) Straight	96	a + b + c fully loaded	10 8477 096 001 025	10 8477 096 001 049
	64	a + c fully loaded	10 8477 096 001 026	10 8477 096 001 050
	32	a + c even loading	10 8477 096 001 033	10 8477 096 001 057
	32	a loading only	10 8477 096 001 027	10 8477 096 001 051
	94 + 2	fully loaded + ground	10 8477 096 101 025	10 8477 096 101 049
4.5 mm (Y) Straight	96	a + b + c fully loaded	10 8477 096 002 025	10 8477 096 002 049
	64	a + c fully loaded	10 8477 096 002 026	10 8477 096 002 050
	32	a + c even loading	10 8477 096 002 033	10 8477 096 002 057
	32	a loading only	10 8477 096 002 027	10 8477 096 002 051
	94 + 2	fully loaded + ground	10 8477 096 102 025	10 8477 096 102 049
9.5 mm (Y) Straight	96	a + b + c fully loaded	10 8477 096 005 025	10 8477 096 005 049
	64	a + c fully loaded	10 8477 096 005 026	10 8477 096 005 050
	32	a + c even loading	10 8477 096 005 033	10 8477 096 005 057
	32	a loading only	10 8477 096 005 027	10 8477 096 005 051
	96	a + b + c fully loaded	10 8477 096 006 025	10 8477 096 006 049
13.0 mm (Y) Straight	64	a + c fully loaded	10 8477 096 006 026	10 8477 096 006 050
	32	a + c even loading	10 8477 096 006 033	10 8477 096 006 057
	32	a loading only	10 8477 096 006 027	10 8477 096 006 051
	94 + 2	fully loaded + ground	10 8477 096 106 025	10 8477 096 106 049
	14.9 mm (Y) Straight	96	a + b + c fully loaded	10 8477 096 007 025
64		a + c fully loaded	10 8477 096 007 026	10 8477 096 007 050
32		a + c even loading	10 8477 096 007 033	10 8477 096 007 057
32		a loading only	10 8477 096 007 027	10 8477 096 007 051
8.8, 11.5, 8.8 mm (Y) Solder Hole		96	a + b + c fully loaded	10 8477 096 009 025
	64	a + c fully loaded	10 8477 096 009 026	10 8477 096 009 050
	32	a + c even loading	10 8477 096 009 033	10 8477 096 009 057
	32	a loading only	10 8477 096 009 027	10 8477 096 009 051
	7.5, 10.2, 7.5 mm (Y) Solder Loop	96	a + b + c fully loaded	10 8477 096 010 025
64		a + c fully loaded	10 8477 096 010 026	10 8477 096 010 050
32		a + c even loading	10 8477 096 010 033	10 8477 096 010 057
32		a loading only	10 8477 096 010 027	10 8477 096 010 051

NB: Alternative Prefix Variations Available: 12, 14, 15, 16 & 17, please refer to Page 10.

Additional Plating & Loading Variations: Please contact your local AVX sales office or distributor.

LOADING DESCRIPTION

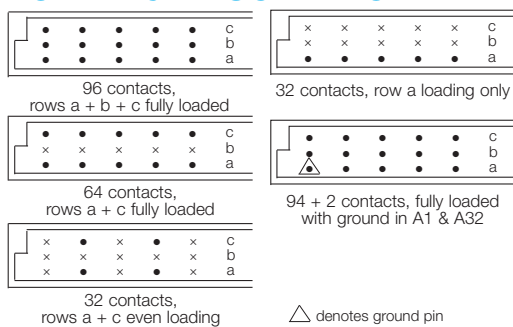

DIMENSIONS

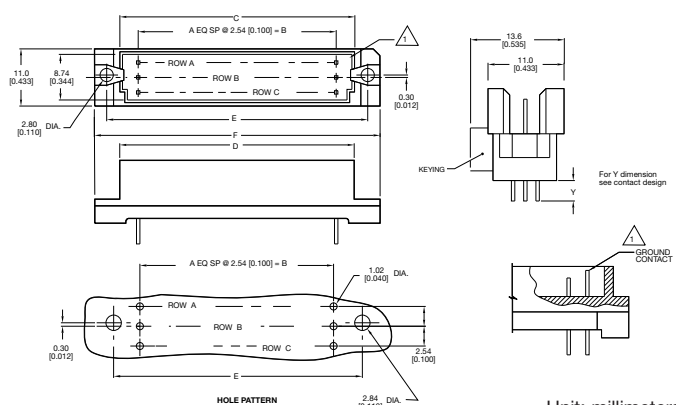

No. Contact Positions	Contact Rows	A	B	C	D	E	F
96	3 (3 x 32)	31	78.74 (3.100)	85.29 (3.358)	87.91 (3.461)	89.99 (3.543)	94.89 (3.736)

Female Style R Expanded



Series 8477 – 4 rows (4 x 32) Inverted

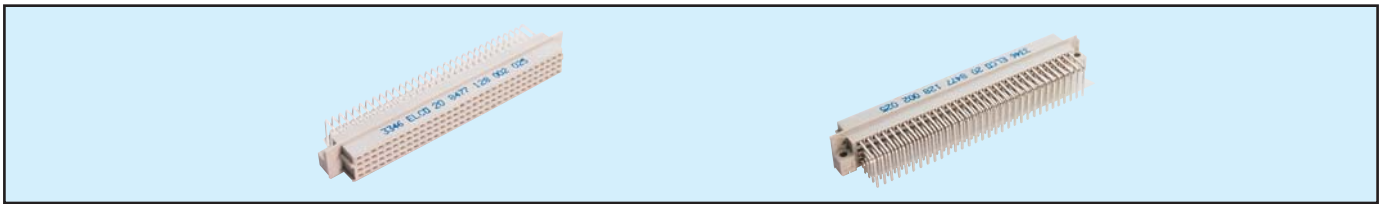

Contact Design and Termination Length	Number of Contacts	Loading Description	Part Number Performance classes according to DIN 41612	
			II	I
0.6 x 0.6 mm Post Profile 3.0 mm (Y) Right Angled	128	a + b + c + d fully loaded	20 8477 128 002 025	20 8477 128 002 049
0.6 x 0.6 mm Post Profile 11.43 mm (Y) Right Angled	128	a + b + c + d fully loaded	20 8477 128 008 025	20 8477 128 008 049
0.6 x 0.6 mm Post Profile 4.5 mm (Y) Right Angled	128	a + b + c + d fully loaded	20 8477 128 012 025	20 8477 128 012 049

NB: Alternative Prefix Variations Available: 22, 26 & 27, please refer to Page 10.
Additional Plating & Loading Variations: Please contact your local AVX sales office or distributor.

LOADING DESCRIPTION DIMENSIONS

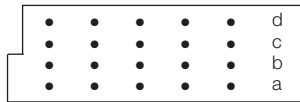

128 contacts,
rows a + b + c + d fully loaded

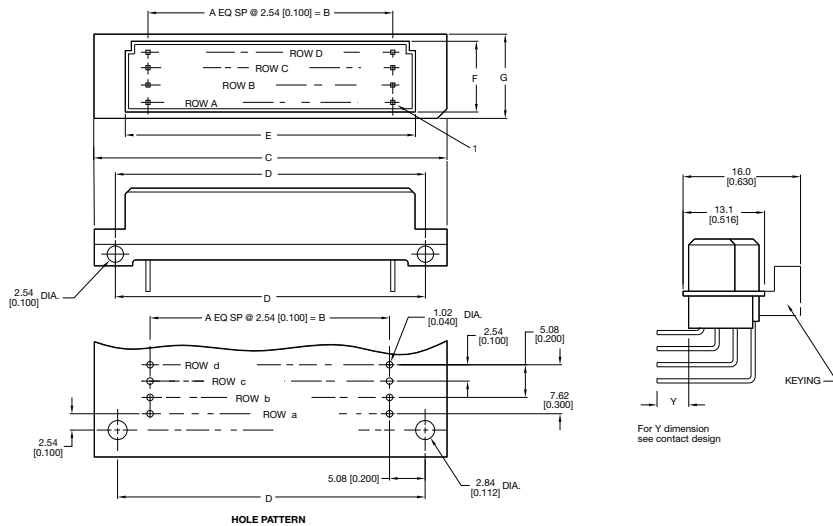

Unit: millimeters (inches)

No. Contact Positions	Contact Rows	A	B	C	D	E	F	G
128	4 (4 x 32)	31	78.74 (3.100)	93.90 (3.697)	88.90 (3.500)	84.90 (3.343)	11.10 (0.437)	13.10 (0.516)

Male Style R Expanded



Series 8477 – 4 rows (4 x 32) Inverted



Contact Design and Termination Length	Number of Contacts	Loading Description	Part Number Performance classes according to DIN 41612	
			II	I
2.9 mm (Y) Straight	128	a + b + c + d fully loaded	10 8477 128 001 025	10 8477 128 001 049
	126 + 2	4 rows fully loaded + ground	10 8477 128 101 025	10 8477 128 101 049
4.5 mm (Y) Straight	128	a + b + c + d fully loaded	10 8477 128 002 025	10 8477 128 002 049
	126 + 2	4 rows fully loaded + ground	10 8477 128 102 025	10 8477 128 102 049
9.5 mm (Y) Straight	128	a + b + c + d fully loaded	10 8477 128 005 025	10 8477 128 005 049
13.0 mm (Y) Straight	128	a + b + c + d fully loaded	10 8477 128 006 025	10 8477 128 006 049
14.9 mm (Y) Straight	128	a + b + c + d fully loaded	10 8477 128 007 025	10 8477 128 007 049

NB: Alternative Prefix Variations Available: 12, 14, 15, 16 & 17, please refer to Page 10.
Additional Plating & Loading Variations: Please contact your local AVX sales office or distributor.

LOADING DESCRIPTION

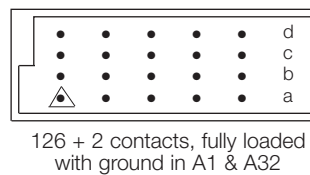
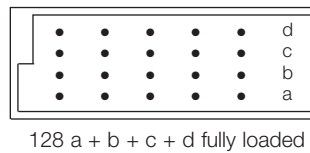

DIMENSIONS

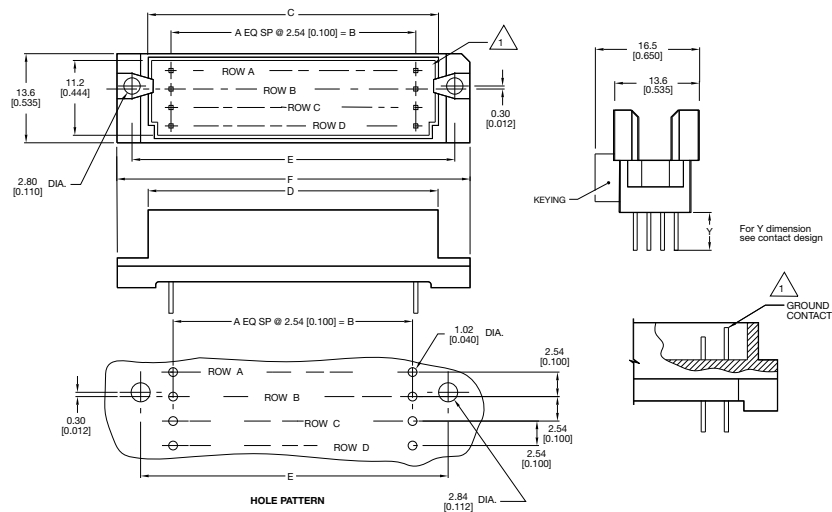

Unit: millimeters (inches)

No. Contact Positions	Contact Rows	A	B	C	D	E	F
128	4 (4 x 32)	31	78.74 (3.100)	85.29 (3.358)	87.91 (3.461)	89.99 (3.543)	94.89 (3.736)

△ denotes ground pin

Female Style R Expanded



Series 8477 – 5 rows (5 x 32) Inverted



Contact Design and Termination Length	Number of Contacts	Loading Description	Part Number Performance classes according to DIN 41612	
			II	I
0.6 x 0.6 mm Post Profile 3.0 mm (Y) Right Angled	160	a + b + c + d + e fully loaded	20 8477 160 002 025	20 8477 160 002 049
0.6 x 0.6 mm Post Profile 4.5 mm (Y) Right Angled	160	a + b + c + d + e fully loaded	20 8477 160 012 025	20 8477 160 012 049

NB: Alternative Prefix Variations Available: 22, 26 & 27, please refer to Page 10.
Additional Plating & Loading Variations: Please contact your local AVX sales office or distributor.

LOADING DESCRIPTION

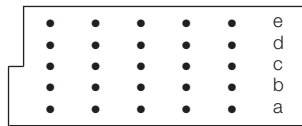

160 contacts,
rows a + b + c + d + e fully loaded

DIMENSIONS

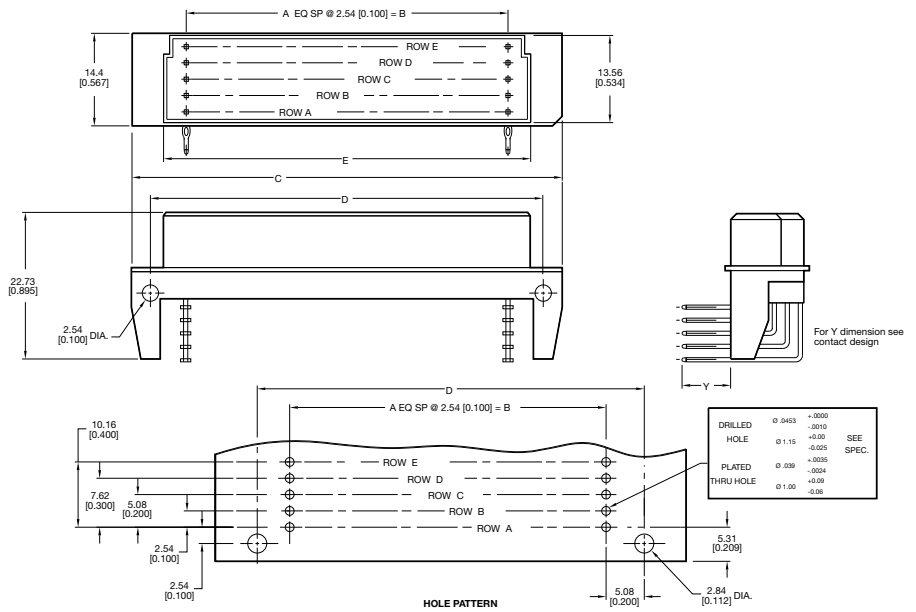

Unit: millimeters (inches)

No. Contact Positions	Contact Rows	A	B	C	D	E	F	G
160	5 (5 x 32)	31	78.74 (3.100)	93.90 (3.697)	88.90 (3.500)	84.90 (3.343)	11.10 (0.437)	13.10 (0.516)

Male Style R Expanded



Series 8477 – 5 rows (5 x 32) Inverted

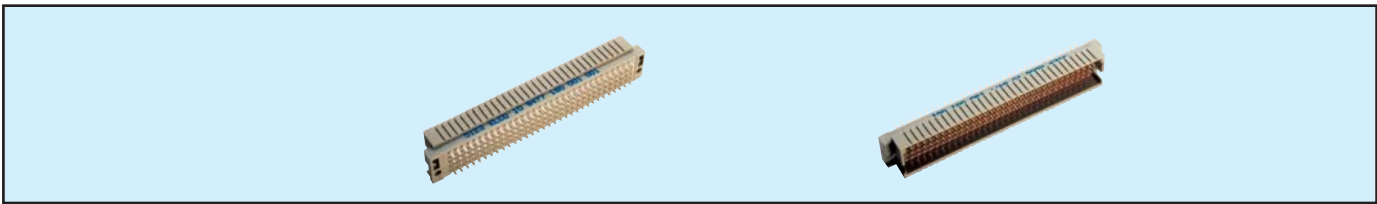

Contact Design and Termination Length	Number of Contacts	Loading Description	Part Number Performance classes according to DIN 41612	
			II	I
2.9 mm (Y) Straight	160	a + b + c + d + e fully loaded	10 8477 160 001 025	10 8477 160 001 049
	158 + 2	5 rows fully loaded + ground	10 8477 160 101 025	10 8477 160 101 049
4.5 mm (Y) Straight	160	a + b + c + d + e fully loaded	10 8477 160 002 025	10 8477 160 002 049
	158 + 2	5 rows fully loaded + ground	10 8477 160 102 025	10 8477 160 102 049
9.5 mm (Y) Straight	160	a + b + c + d + e fully loaded	10 8477 160 005 025	10 8477 160 005 049
13.0 mm (Y) Straight	160	a + b + c + d + e fully loaded	10 8477 160 006 025	10 8477 160 006 049
	158 + 2	5 rows fully loaded + ground	10 8477 160 106 025	10 8477 160 106 049
14.5 mm (Y) Straight	160	a + b + c + d + e fully loaded	10 8477 160 007 025	10 8477 160 007 049

NB: Alternative Prefix Variations Available: 12, 14, 15, 16 & 17, please refer to Page 10.

Additional Plating & Loading Variations: Please contact your local AVX sales office or distributor.

LOADING DESCRIPTION

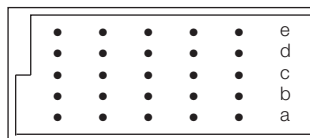

160 a + b + c + d + e fully loaded

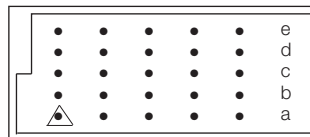

158 + 2 contacts, fully loaded with ground in A1 & A32

DIMENSIONS

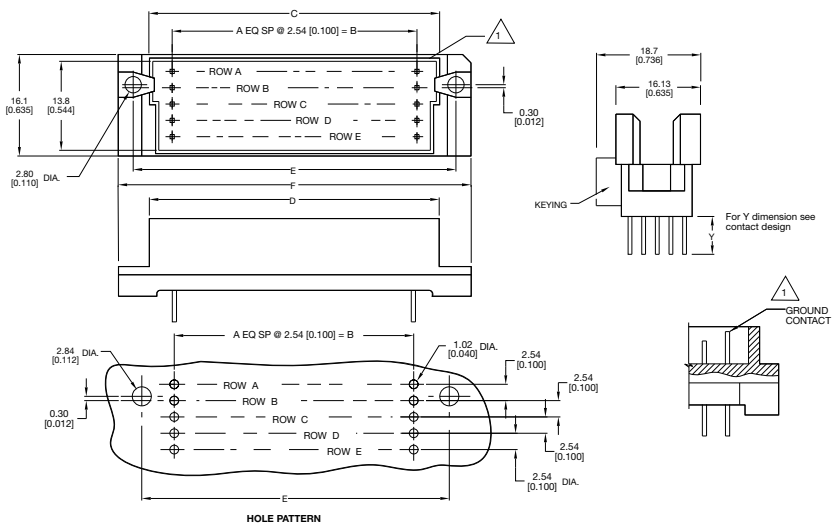

Unit: millimeters (inches)

No. Contact Positions	Contact Rows	A	B	C	D	E	F
160	5 (5 x 32)	31	78.74 (3.100)	85.29 (3.358)	87.91 (3.461)	89.99 (3.543)	94.89 (3.736)

△ denotes ground pin