

Features

- Mini-compact size: 5.5 mm diameter, 6 mm length
- Axial leaded device
- High voltage range up to 4 kV
- High insulation resistance
- RoHS compliant*
-  UL Recognized

Applications

- Industrial equipment/electronics
- Telecommunications electronics
- Consumer electronics

2089 Series High Voltage Mini-2-Electrode Gas Discharge Tube

Characteristics

Test Methods per ITU-T (CCITT) K.12 and IEC 61643-311.

Characteristic	Model No.				
	2089-100	2089-120	2089-140	2089-160	2089-200
DC Sparkover $\pm 20\%$ @ 100 V/s	1000 V	1200 V	1400 V	1600 V	2000 V
Impulse Sparkover 100 V/ μ s 1000 V/ μ s	< 1300 V < 1400 V	< 1800 V < 2000 V	< 2200 V < 2400 V	< 2400 V < 2600 V	< 2800 V < 3000 V

Characteristic	Model No.			
	2089-250	2089-300	2089-350	2089-360
DC Sparkover $\pm 20\%$ @ 100 V/s	2500 V	3000 V	3500 V	3600 V
Impulse Sparkover 100 V/ μ s 1000 V/ μ s	< 3300 V < 3500 V	< 3800 V < 4000 V	< 4300 V < 4500 V	< 4400 V < 4600 V

Insulation Resistance (IR) ¹	500/1000 Vdc.....	> 1 G Ω
Glow Voltage	10 mA.....	~ 60 V
Arc Voltage	1 A.....	~ 15 V
Capacitance.....	1 MHz	< 1.5 pF
Impulse Discharge Current.....	3,000 A, 8/20 μ s.....	1 operation
.....	1,500 A, 8/20 μ s.....	10 operations
Alternating Discharge Current	2 Arms, 50 Hz, 1 second.....	1 operation min.
.....	4 Arms, 50 Hz, 9 cycles	1 operation min.
Impulse Life	100 A, 10/1000 μ s.....	> 300 operations
Operating Temperature.....		-30 to +85 °C
Storage Temperature		-40 to +115 °C
Climatic Category (IEC 60068-1).....		40 / 90 / 21

Notes:

- UL Recognized component: UL File E135337.
- At delivery AQL 0.65 Level II, DIN ISO 2859.

Note 1: DC Breakdown IR Measuring Voltage

1000–2000 V	500 V
2500–3600 V	1000 V

BOURNS®

Asia-Pacific: Tel: +886-2 2562-4117 • Fax: +886-2 2562-4116

Europe: Tel: +41-41 768 5555 • Fax: +41-41 768 5510

The Americas: Tel: +1-951 781-5500 • Fax: +1-951 781-5700

www.bourns.com

2089 Series High Voltage Mini-2-Electrode Gas Discharge Tube

BOURNS®

Product Dimensions

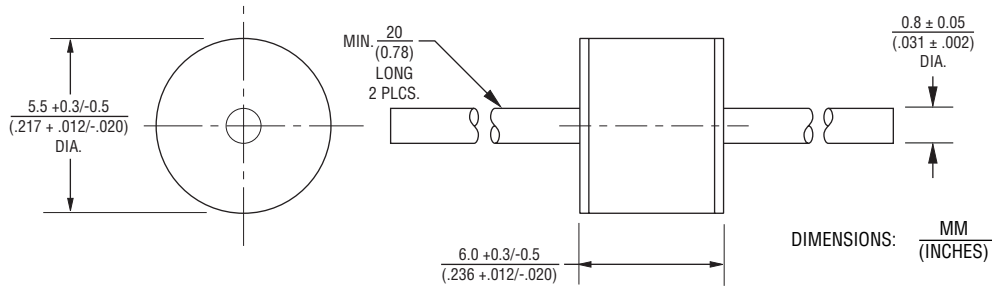

Packaging Specifications

Model 2089 ships standard bulk, 100 pcs. per tray; 5 trays per box (500 units). The optional reelpack (-BT1) contains 500 pcs. per reel; 2 reels per box (1K units).

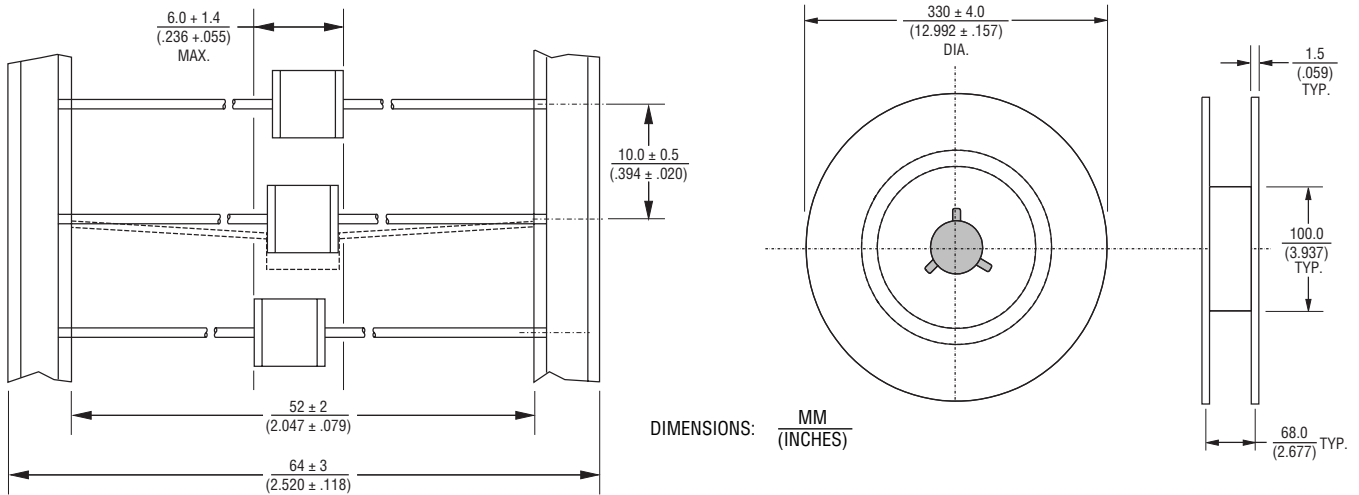

How to Order

2089 - xxx - B T1 LF

Model Number Designator _____

Voltage (Divided by 10) _____

100 = 1000 V	250 = 2500 V
120 = 1200 V	300 = 3000 V
140 = 1400 V	350 = 3500 V
160 = 1600 V	360 = 3600 V
200 = 2000 V	

Leads _____

B = 0.8 mm

Packaging _____

(Blank) = Bulk Packaging (Standard)
T1 = Reelpack (Optional)

RoHS Compliancy _____

LF = RoHS Compliant Product

BOURNS®

Asia-Pacific:

Tel: +886-2 2562-4117
Fax: +886-2 2562-4116

Europe:

Tel: +41-41 768 5555
Fax: +41-41 768 5510

The Americas:

Tel: +1-951 781-5500
Fax: +1-951 781-5700

www.bourns.com

REV. A 04/12

Specifications are subject to change without notice.
Customers should verify actual device performance in their specific applications.