

LOC	DIST	REV	DATE	BY	CHK	APPD
-	-	B	3-16-10	CT	KH	

- THIS KIT INCLUDES: GPRB1 PLUG SHELL SUB ASSY; TE PART NO. 1738236-1
 GPRBEP3PA 3P3 PIN INSERT; TE PART NO. 1954321-1 (INSTALLED)
 AND SIZE 5 CRIMP PIN CONTACT; TE PART NO. 1738019-1. (NOT INSTALLED)
 - MATERIALS:
 SHELL & KEY RETENTION PLATE: ALUMINUM ALLOY
 QUARTER-TURN FASTENER: COPPER ALLOY PER ASTM B196
 CAPTIVE SCREW: STAINLESS STEEL PER AISI 304
 SCREW RETENTION CLIPS: STAINLESS STEEL PER AISI 304
 INSERT RETENTION CLIP, CURVED WASHER & FASTENER RETENTION CLIP: COPPER ALLOY PER ASTM B194
 POLARIZATION KEY: PEI THERMOPLASTIC PER ASTM D5205
 PROTECTIVE COVER: THERMOPLASTIC ELASTOMER
 - FINISH:
 SHELL: ELECTROLESS NICKEL PER SAE AMS-C-26074, CLASS 1.
 KEY RETENTION PLATE: ANODIZED, COLOR: CLEAR
- 4 TE PART NO. AND DATE CODE MARKED IN THIS AREA.
 5 #4-40 CAPTIVE SCREWS ON KEY RETENTION PLATE RECOMMENDED TORQUE: 0.8 N-m.
 6 THE POLARIZATION KEYS & RETENTION PLATE ARE SHIPPED UNASSEMBLED FOR -1.
7. THIS PRODUCT IS SOLD BY Tyco Electronics UNDER A LICENSE FROM RADIAL SA.

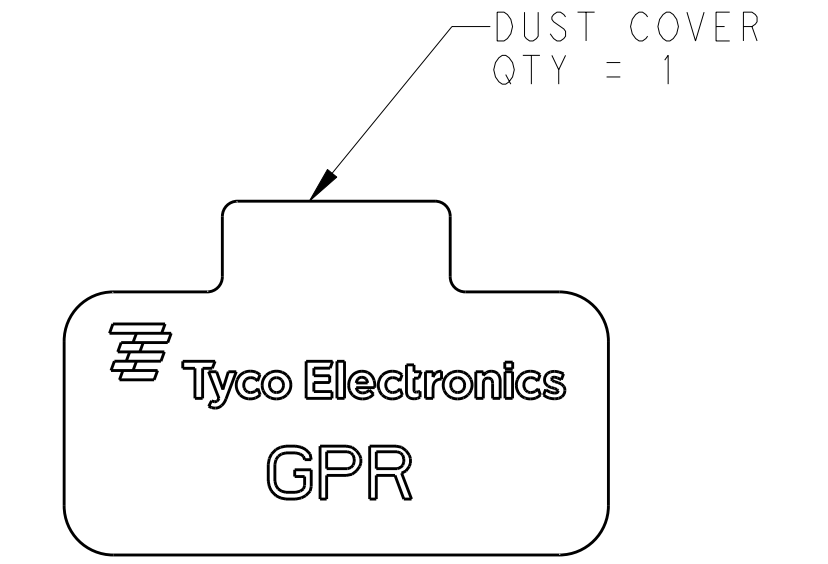

CODE NUMBER	KEY 1	KEY 2
01	A	A
02	A	B
03	A	C
04	A	D
05	B	A
06	B	B
07	B	C
08	B	D
09	C	A
10	C	B
11	C	C
12	C	D
13	D	A
14	D	B
15	D	C
16	D	D

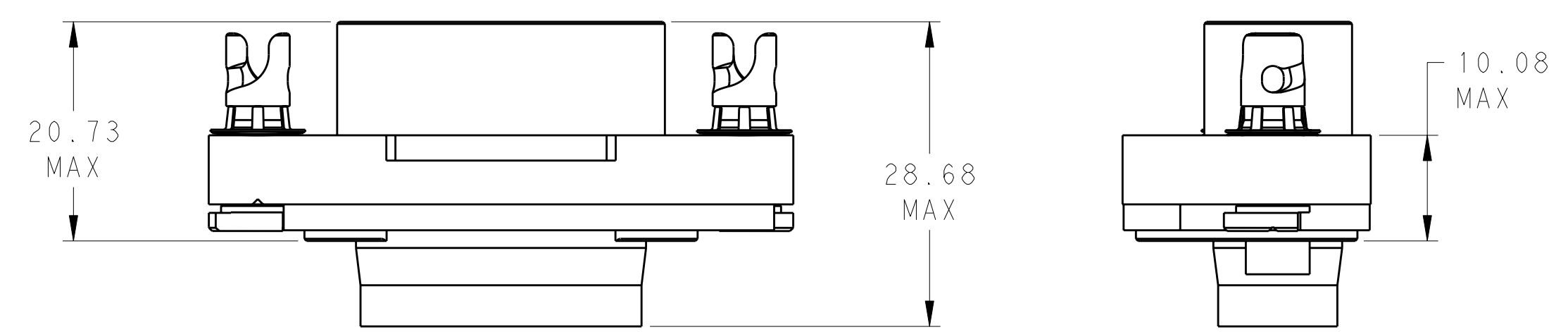
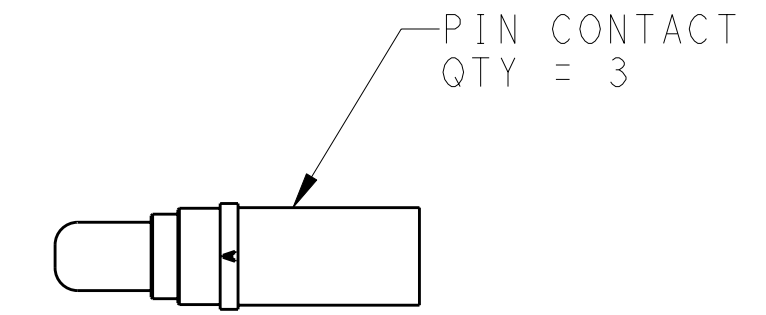
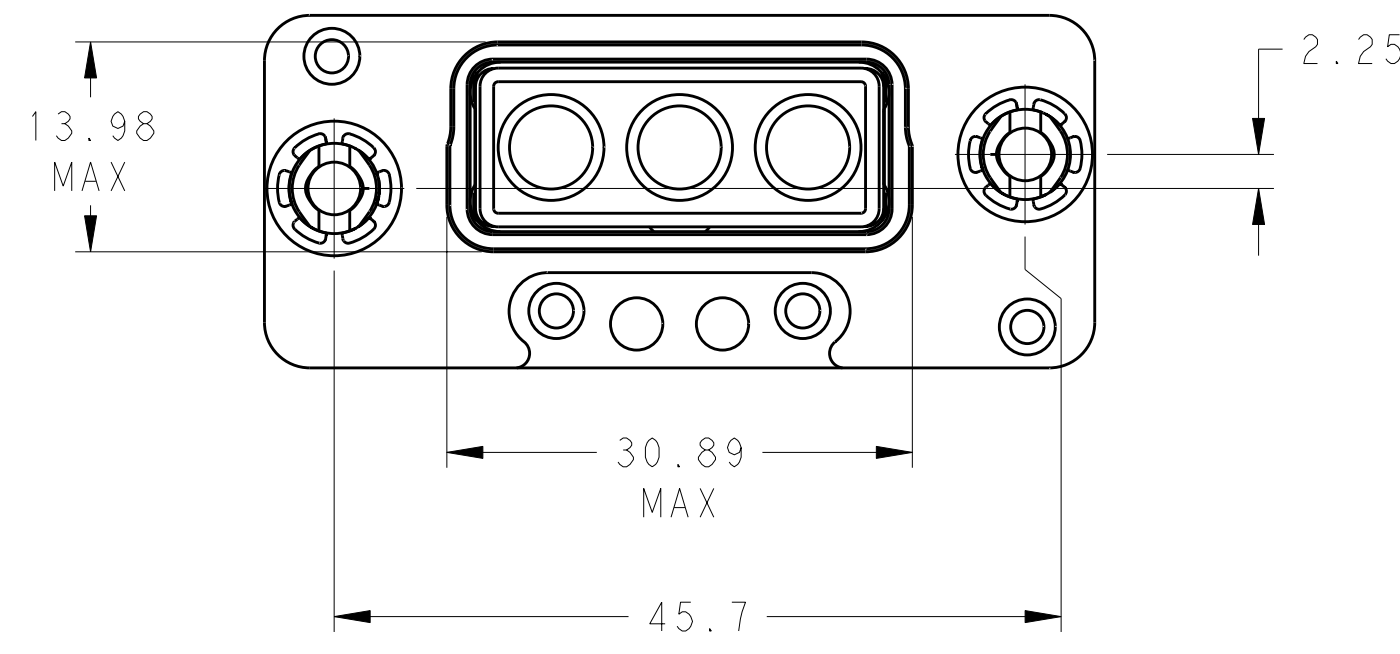
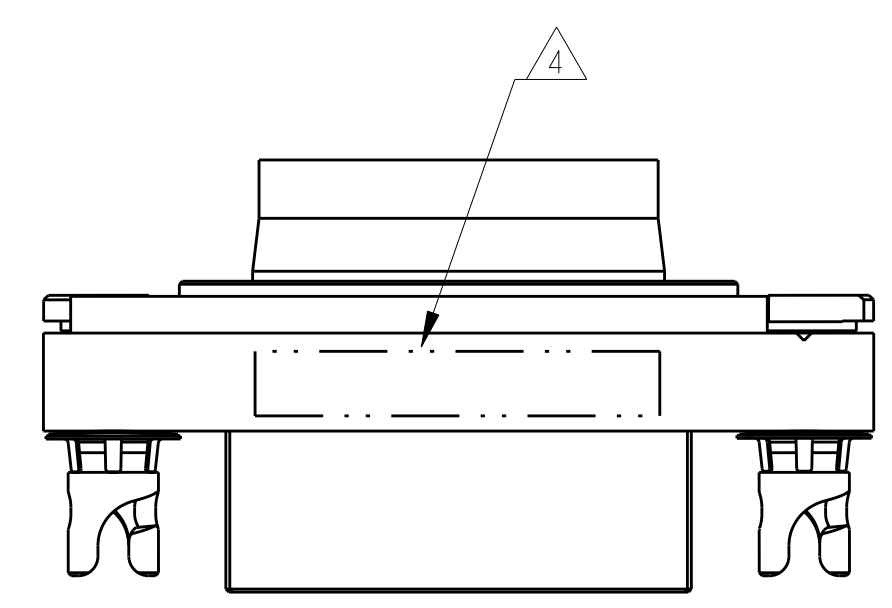
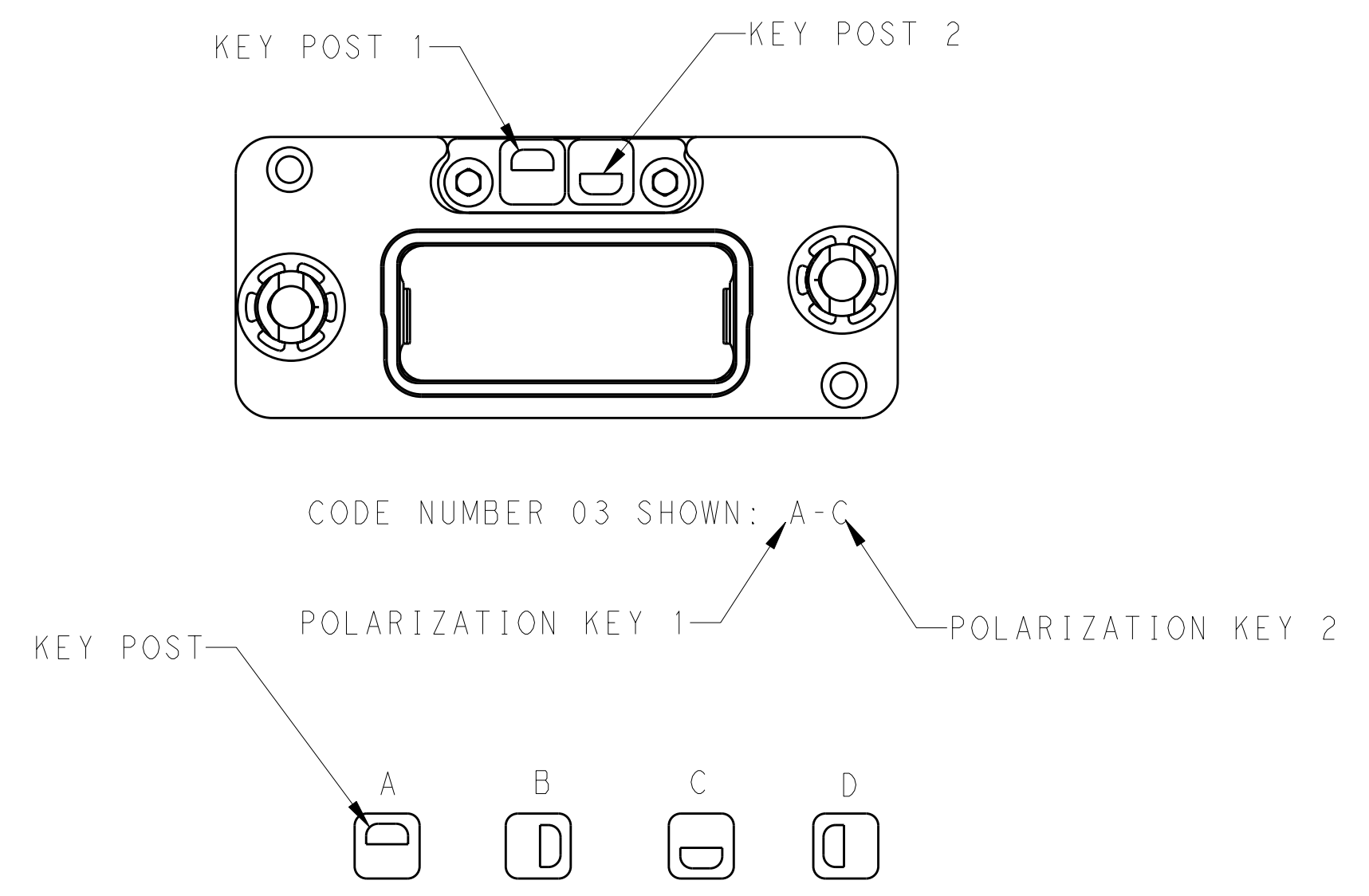
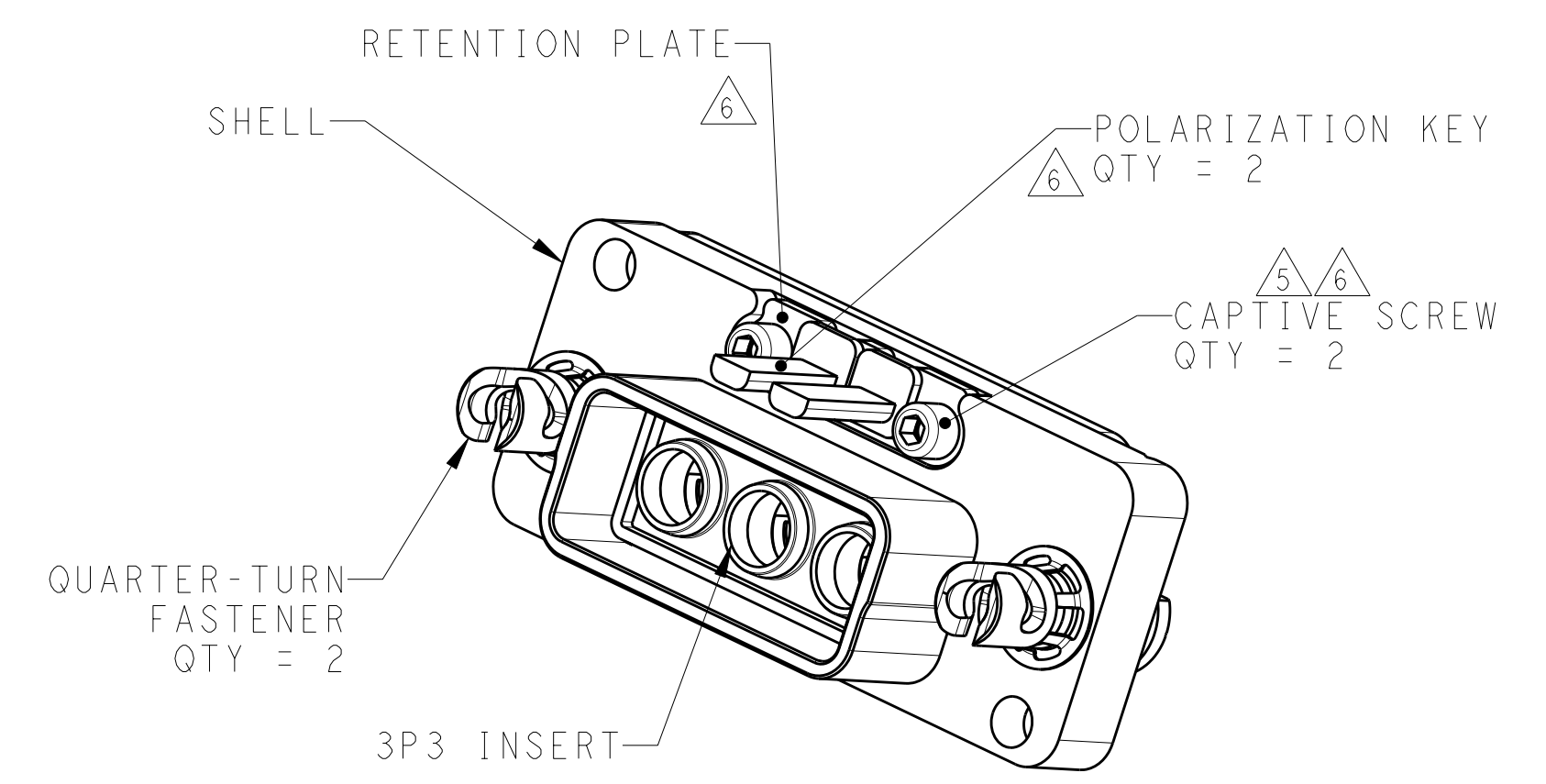
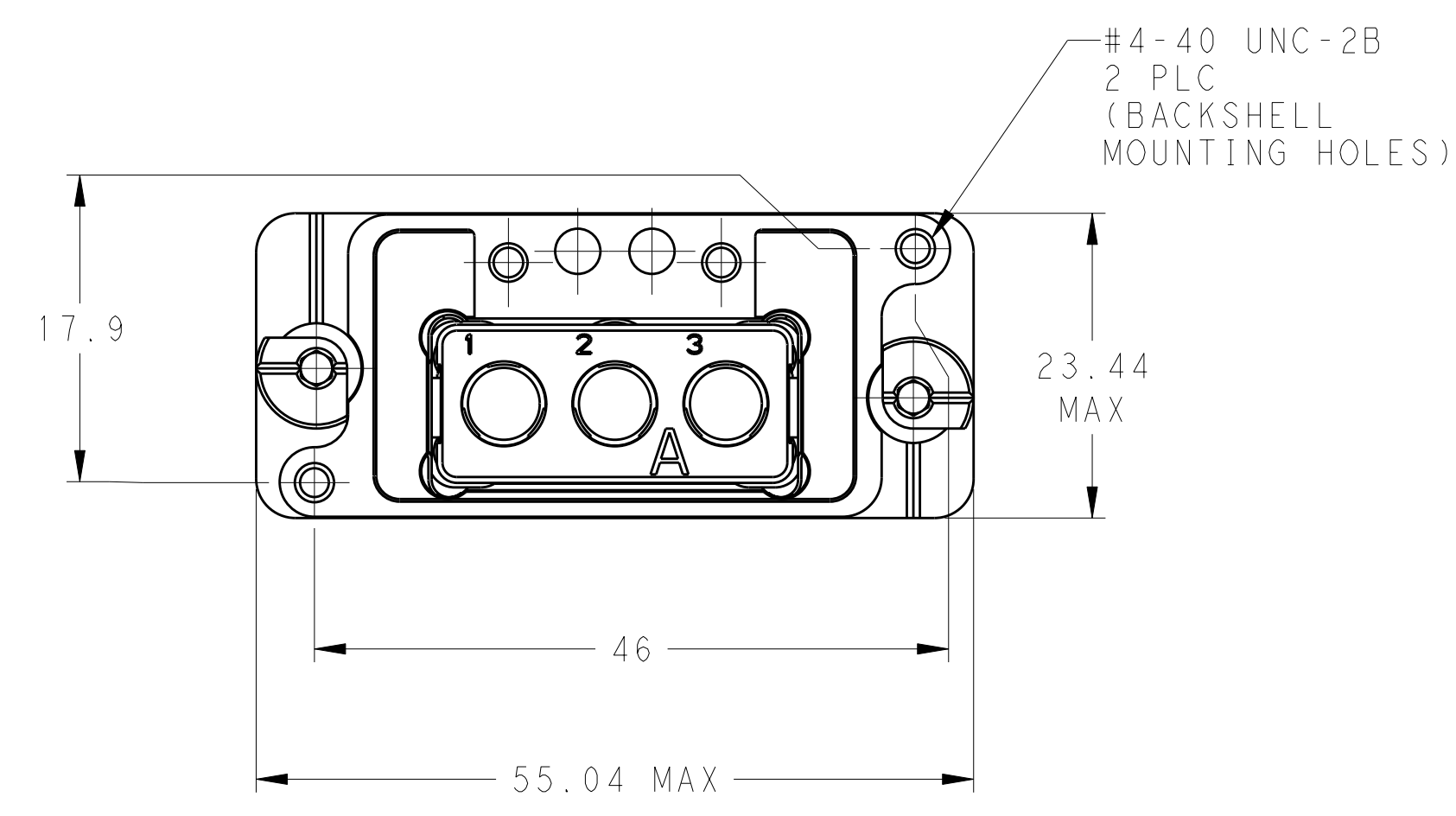

"16"	2101537-5
"11"	2101537-4
"06"	2101537-3
"01"	2101537-2
UNINSTALLED	2101537-1
KEYING POSITIONS	PART NO

PLUG CONNECTOR POLARIZATION SHOWN WITHOUT INSERT

DIMENSIONS:		TOLERANCES UNLESS OTHERWISE SPECIFIED:		MATERIAL:		FINISH:		WEIGHT:		CUSTOMER DRAWING:	
mm	0 PLC ±.5	1 PLC ±.5	2 PLC ±.13	3 PLC ±.013	4 PLC ±.0001	ANGLES	±.0001				

DWN	C. C. THOMAS	11AUG2009	NAME	GPRB1 PLUG ASSY, 3P3 WITH PIN CONTACTS
CHK	K. HOGAN	11AUG2009	PRODUCT SPEC	
APPD	K. HOGAN	11AUG2009	APPLICATION SPEC	
SIZE	CAGE CODE	DRAWING NO	RESTRICTED TO	
A100779	C=2101537			

SCALE 2:1 SHEET 1 OF 1 REV B