



Wi-Fi 6/ 6E TRIPLE BAND EMBEDDED ANTENNA

**Part Number: 2108792-1, 2108792-2
2108792-3, 2108792-4, 2108792-5
2108792-6, 2108792-7, 2108792-8
2108792-9**

FEATURES & BENEFITS

- WiFi 6, also including WiFi 6E new 6GHz band, Bluetooth, ZigBee
- Adhesive backing on the FPC simplifies mounting within the device
- Global Frequency coverage
- FPC antenna assembly
- Different cable length and connector options available

SPECIFICATIONS (Shown as 2108792-1 : Others can vary with different cable lengths.)

Frequency Range (MHz)	2400-2500	5150-5875	5925-7125
VSWR	< 2.1:1	< 2.1:1	< 1.7:1
Average Efficiency	73%	62%	69%
Peak Gain	4.9dBi	3.5dBi	4.5dBi
Average Gain	-1.4dBi	-2.1dBi	-1.7dBi
Power Handling	10 Watt cw		
Feed Point Impedance	50 ohms unbalanced		
Polarization	Linear		
Size	40.0 mm x 10.0 mm x 0.12 mm		
Weight	< 0.9 g		
Mounting	Adhesive Tape		
Mating Connector	MHF and MHF 4L-type Refer to page 5		
Cable(Coaxial)	1.13mm Dia. Refer to page 5		
Operating Temperature	-40 to +85°C		
Storage Temperature	-40 to +85°C		
Hazardous Materials	A certificate of conformance is available from the product page on TE website.		

RF DATA (Shown as 2108792-1 : Others can vary with different cable lengths.)

VSWR

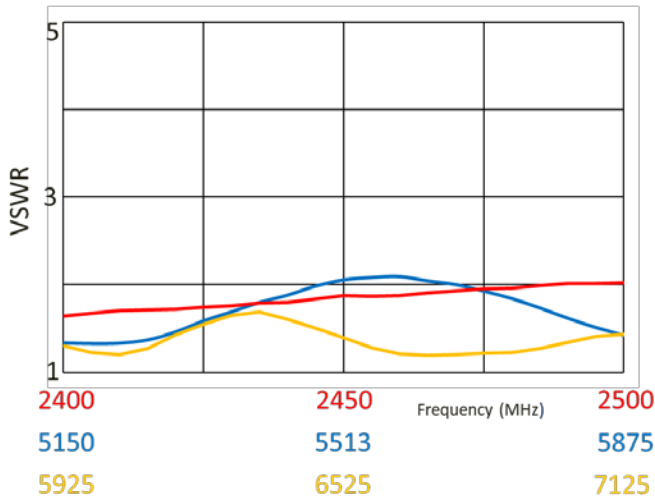

Return Loss

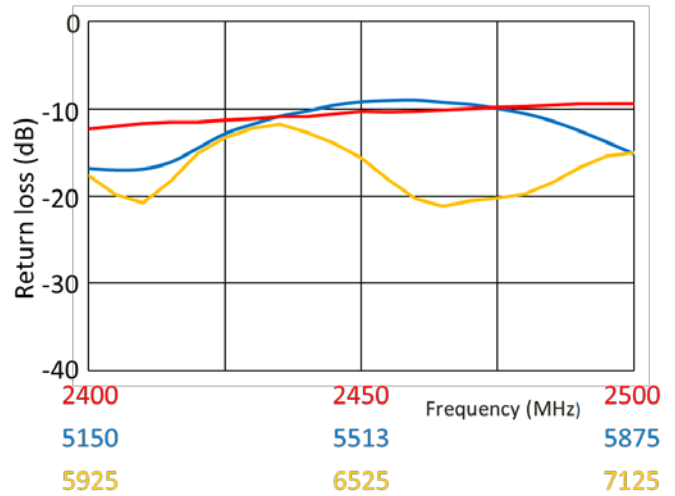

Efficiency

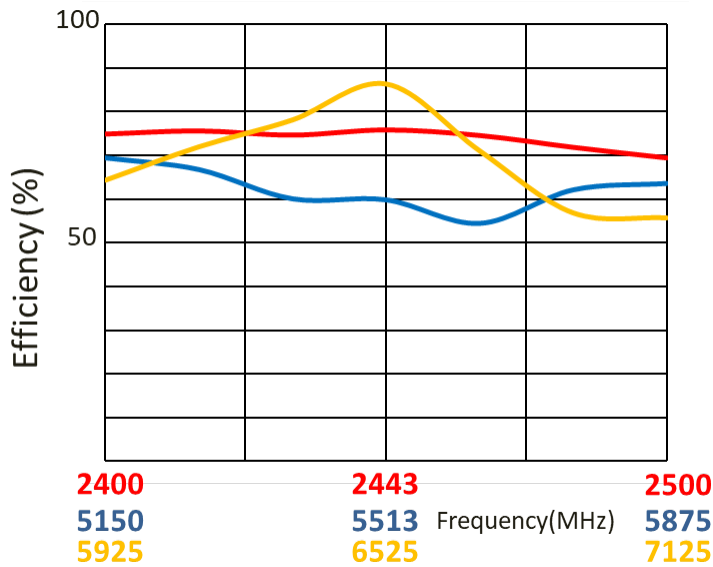

Data measured in free space and on plastic device enclosure

RADIATION PATTERN

(Shown as 2108792-1 : Others can vary with different cable lengths.)

Test setup

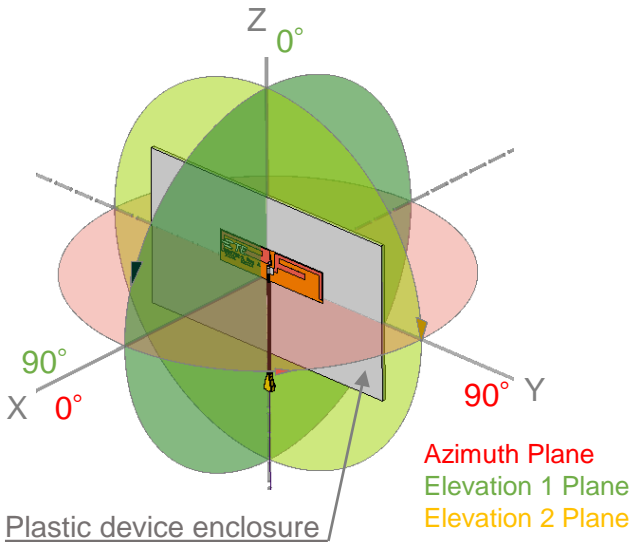

Azimuth

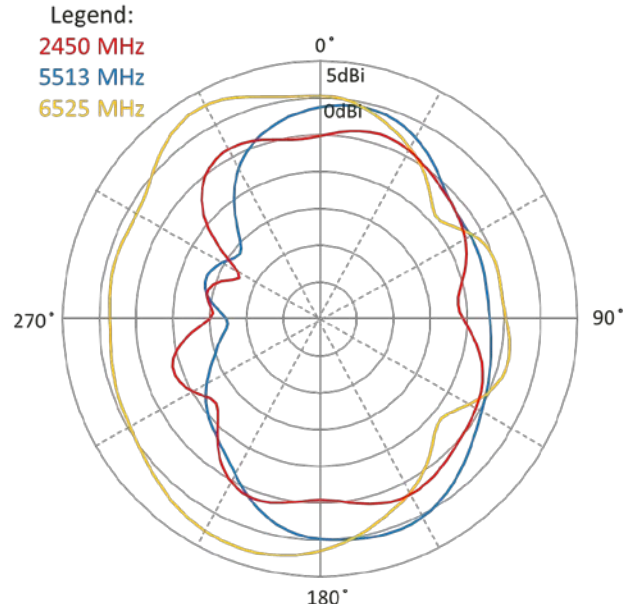

Elevation 1

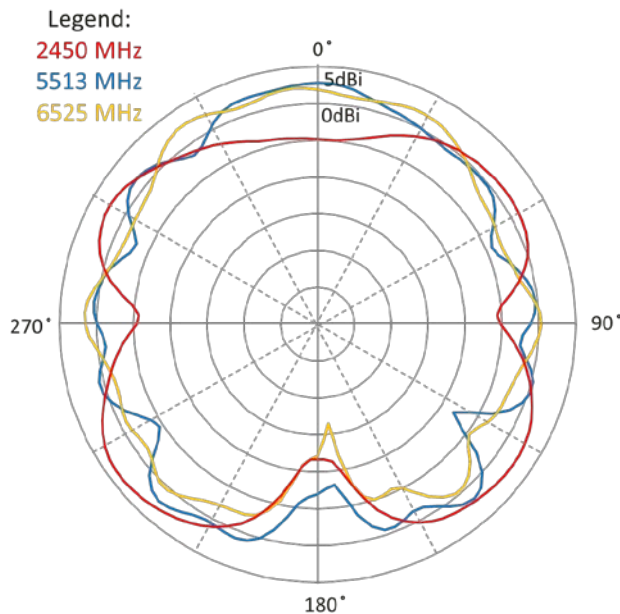

Elevation 2

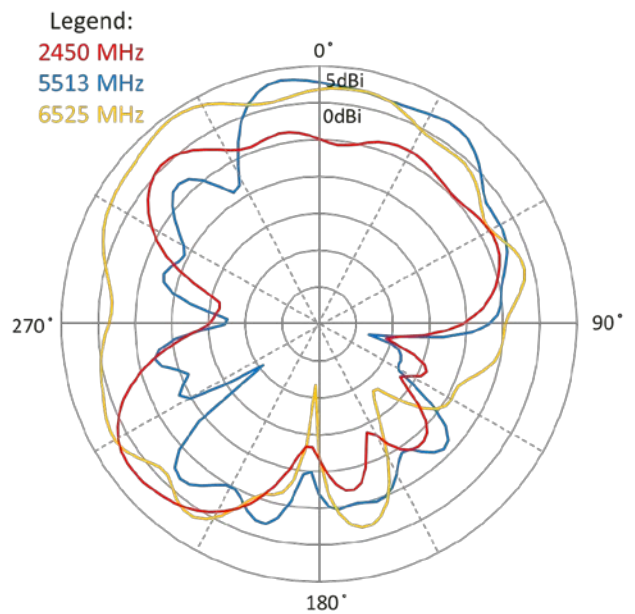

Data measured in free space and on plastic device enclosure

KEEP OUT AREA

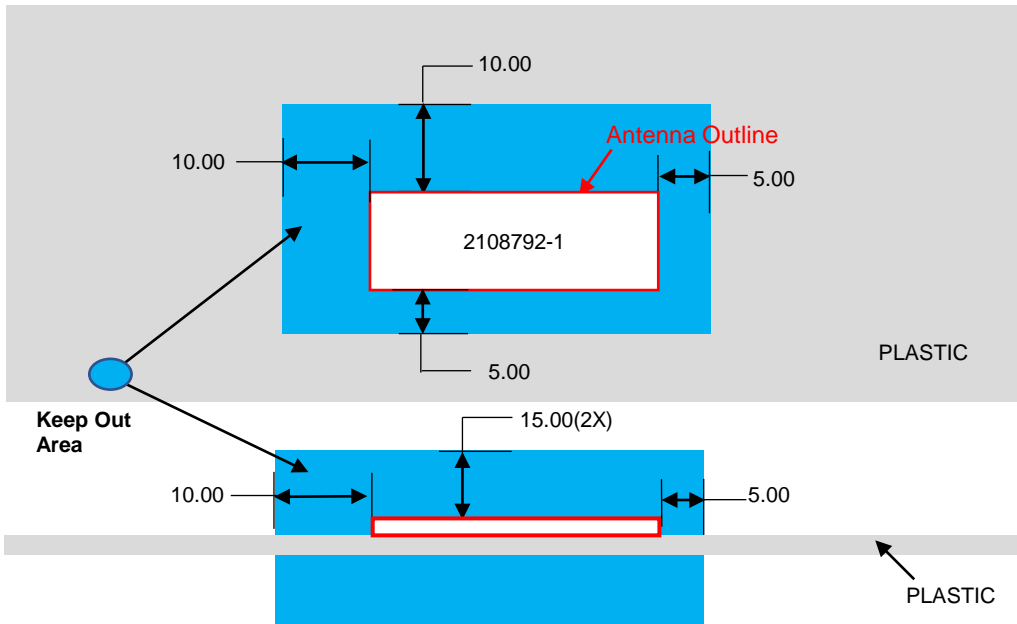

- NOTES: 1. Antenna designed to be mounted on plastic cover.
 2. Area in blue above indicates Keep Out Area.
 3. For more information please call TE.

Dimensions: mm
 Diagram is not to scale

DIMENSIONS

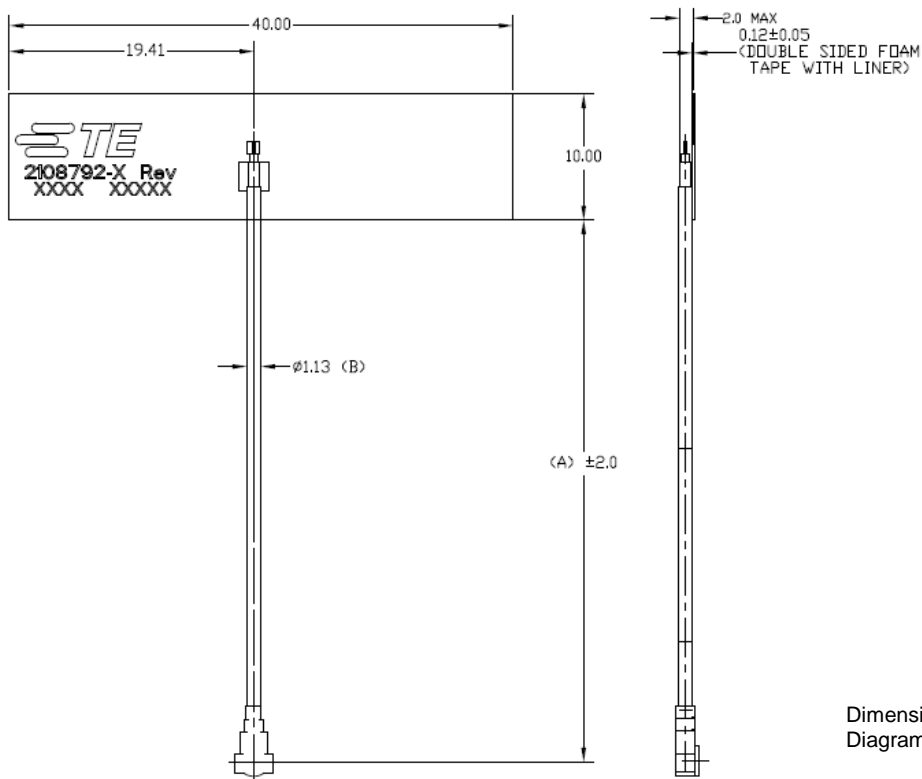

Dimensions: mm
 Diagram is not to scale