



Wi-Fi 6/ 6E TRIPLE BAND EMBEDDED ANTENNA

**Part Numbers: 2108857-1, 2108857-2
2108857-3, 2108857-4
2108857-5, 2118857-6
2108857-7, 2108857-8**

FEATURES & BENEFITS

- WiFi 6, also including WiFi 6E new 6GHz band, Bluetooth, ZigBee
- Adhesive backing on the PCB simplifies mounting within the device
- Global Frequency coverage
- PCB antenna assembly
- Wide selection of micro-coaxial cable lengths

SPECIFICATIONS (Shown as 2108857-1 : Others can vary with different cable lengths.)

Frequency Range (MHz)	2400-2500	5150-5875	5925-7125
VSWR	< 2.0:1	< 2.2:1	< 2.0:1
Average Efficiency	71%	71%	77%
Peak Gain	2.5dBi	4.6dBi	5.0dBi
Average Gain	-1.5dBi	-1.5dBi	-1.2dBi
Power Handling	10 Watt cw		
Feed Point Impedance	50 ohms unbalanced		
Polarization	Linear		
Size	30.0 mm x 7.0 mm x 0.78 mm		
Weight	< 0.8 g		
Mounting	Adhesive Tape		
Mating Connectors	MHF and MHF4-type Refer to page 5		
Cable (Coaxial)	0.81mm and 1.37mm Dia., Refer to page 5		
Operating Temperature	-40 to +85°C		
Storage Temperature	-40 to +85°C		
Hazardous Materials	A certificate of conformance is available from the product page on TE website.		

RF DATA (Shown as 2108857-1 : Others can vary with different cable lengths.)

VSWR

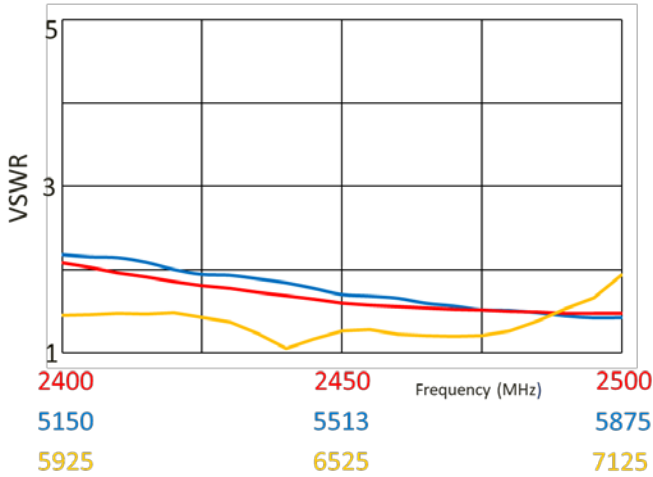

Return Loss

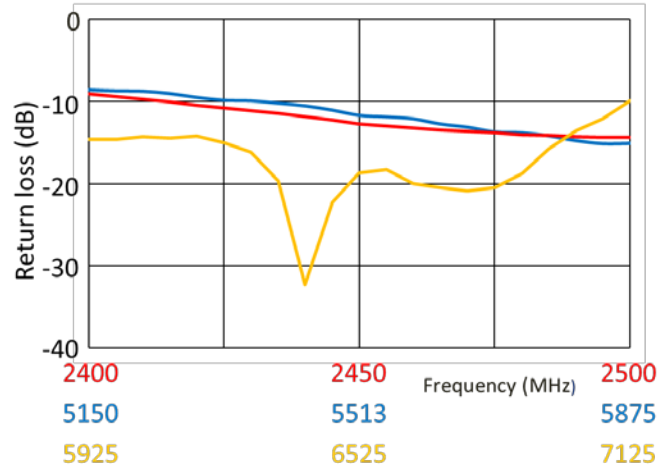

Efficiency

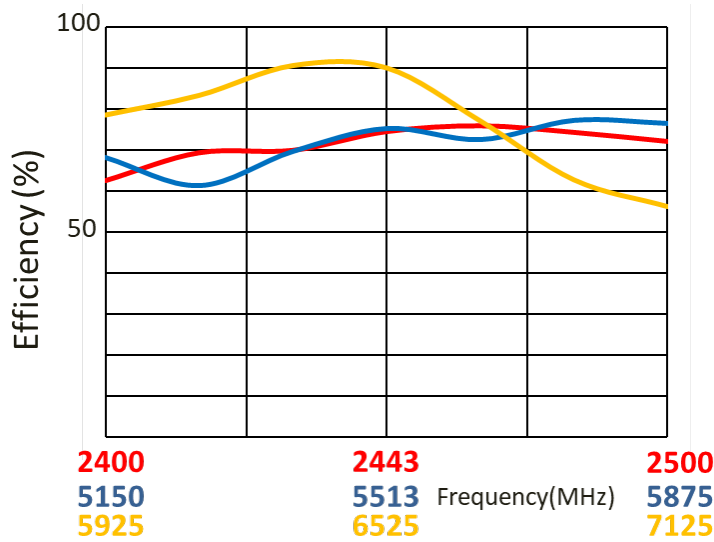

Data measured in free space and on plastic device enclosure

RADIATION PATTERN

(Shown as 2108857-1 : Others can vary with different cable lengths.)

Test setup

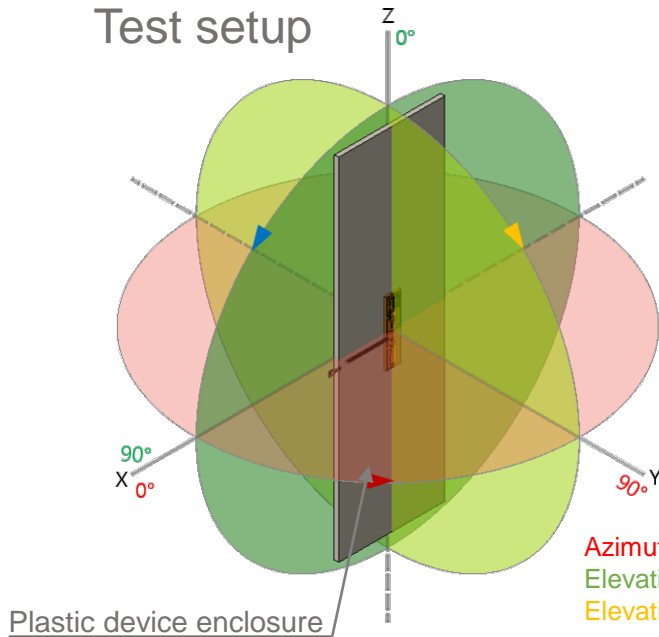

Azimuth

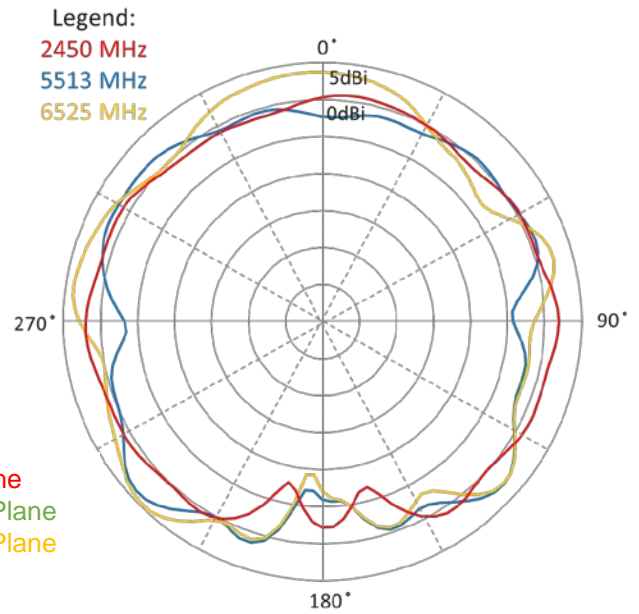

Elevation 1

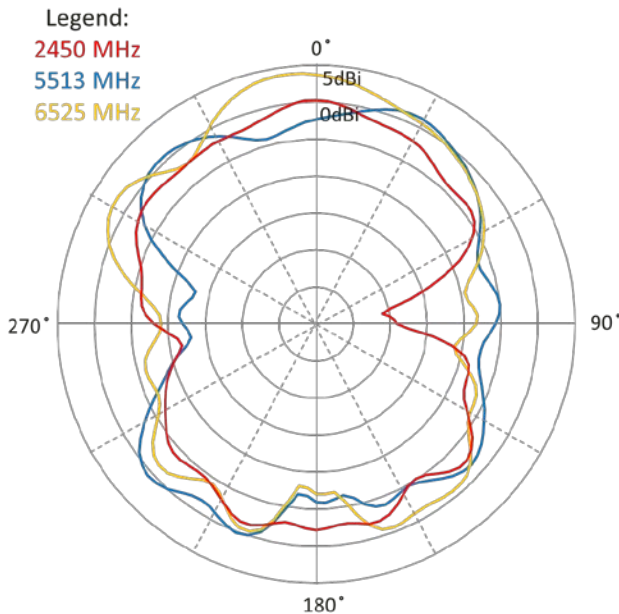

Elevation 2

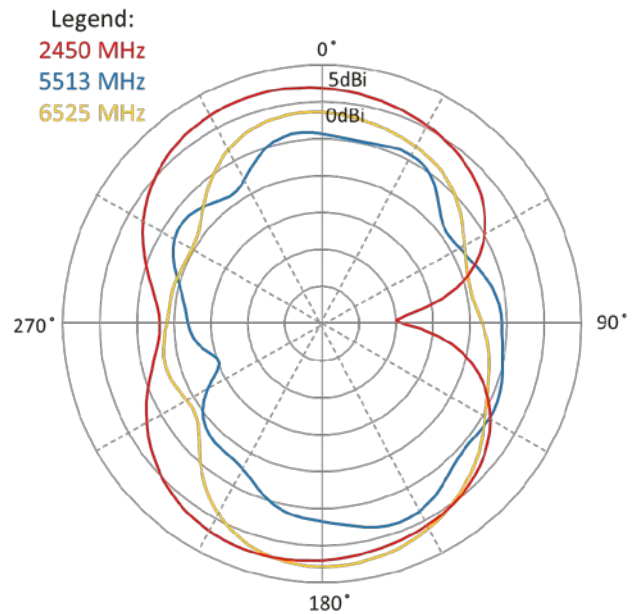

Data measured in free space and on plastic device enclosure

KEEP OUT AREA

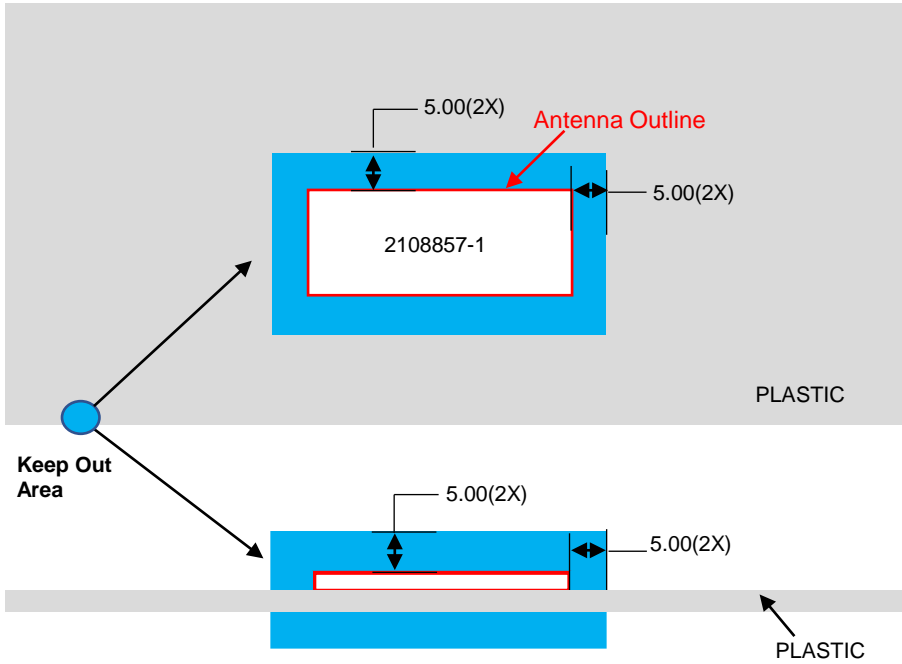

- NOTES: 1. Antenna designed to be mounted on plastic cover.
 2. Area in blue above indicates Keep Out Area.
 3. For more information please call TE.

Dimensions: mm
 Diagram is not to scale

DIMENSIONS

(Refer to Page 5 for dimension "A" and "B")

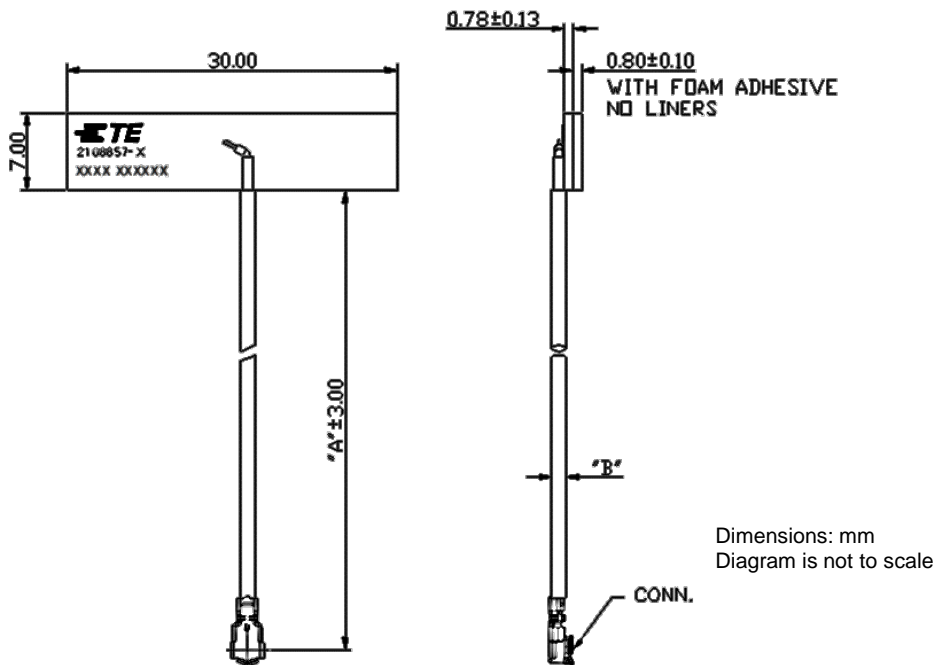

Dimensions: mm
 Diagram is not to scale

MATING COMPONENTS TO PART NUMBERS AND DIMENSIONS

2108857-1	50.0	1.968	1.37	MHF-TYPE PLUG	RECEPTACLE (TE PN: 2337019-1)	
2108857-2	100.0	3.937	1.37	MHF-TYPE PLUG	RECEPTACLE (TE PN: 2337019-1)	
2108857-3	150.0	5.905	1.37	MHF-TYPE PLUG	RECEPTACLE (TE PN: 2337019-1)	
2108857-4	200.0	7.784	1.37	MHF-TYPE PLUG	RECEPTACLE (TE PN: 2337019-1)	
2108857-5	50.0	1.968	0.81	MHF4-TYPE PLUG	RECEPTACLE (TE PN: 2334884-1)	
2108857-6	100.0	3.937	0.81	MHF4-TYPE PLUG	RECEPTACLE (TE PN: 2334884-1)	
2108857-7	150.0	5.905	0.81	MHF4-TYPE PLUG	RECEPTACLE (TE PN: 2334884-1)	
2108857-8	200.0	7.784	0.81	MHF4-TYPE PLUG	RECEPTACLE (TE PN: 2334884-1)	
PART NUMBERS	MM	INCH	CABLE O.D(B), MM	CONNECTOR TYPE (ON CABLE)	PART NUMBER	IMAGE
	CABLE LENGTH(A)				MATING COMPONENTS	

PACKAGING

