

698-960, 1710-2170 & 2300-2700 MHz LTE/Cell Band Antenna
 (includes frequencies of LTE, UMTS, US Dual, EU Triband, and WCDMA products)

Part Number: 2118308-1

Product Facts

- Uses MetaSpan metamaterial product technology to cover virtually all cell bands in one compact antenna assembly.
- RoHS compliant.

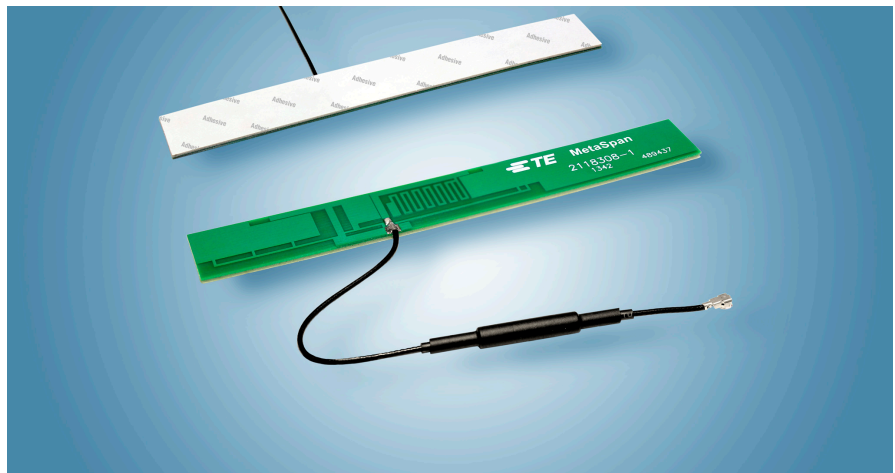

Recommendations

- For best performance follow **Mounting Guide and Keep Out Area** on next page.

Specifications

Frequency Range (MHz)	698–960; 1710–2170; 2300–2700
Peak Gain	+3.9 dBi
VSWR	< 3.0:1
Polarization	Linear
Power Handling	3 Watt cw
Feed Point Impedance	50 Ohms unbalanced
Size	110.0 mm x 14.0 mm x 1.31 mm
Weight	4.2 g.
Mounting	Adhesive. See diagram on page 2.
Keep Out Area	See diagram on page 2.
Cable / Connector	120 mm length. 1.13 mm dia. with TE MCIS connector

Test Orientation in Free Space

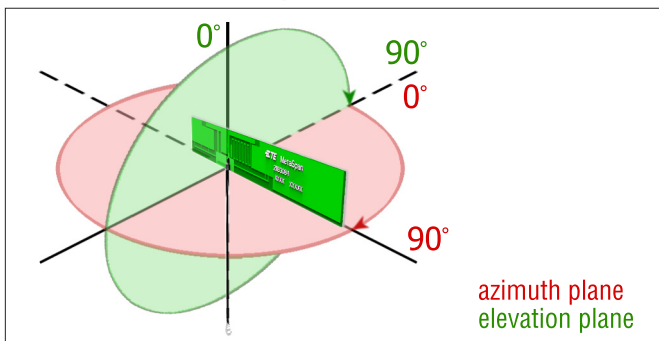

VSWR

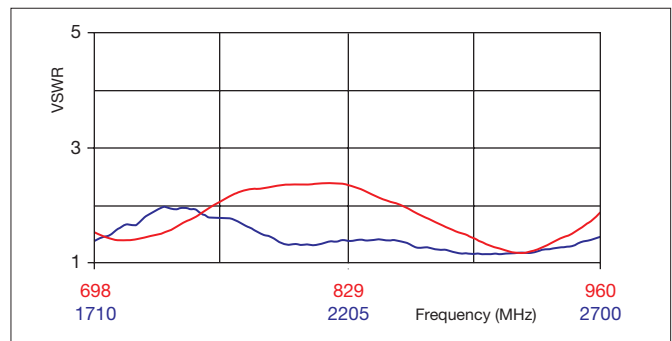

Azimuth

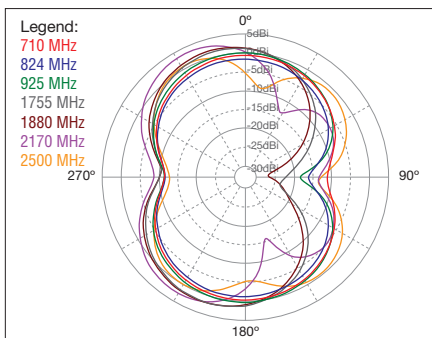

Elevation

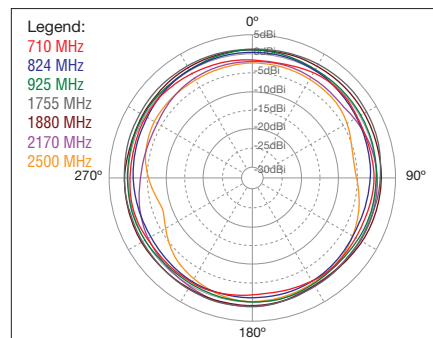

Efficiency

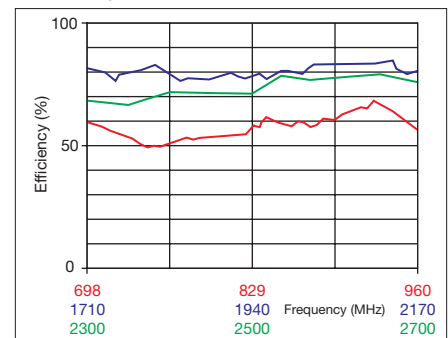

698-960, 1710-2170 & 2300-2700 MHz LTE/Cell Band Antenna
 (includes frequencies of LTE, UMTS, US Dual, EU Triband, and WCDMA products)

Part Number: 2118308-1

Mounting Guide and Keep Out Area

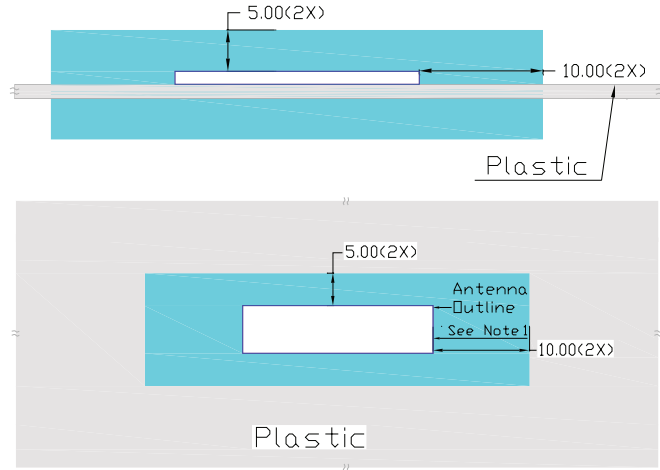

Dimensions: mm
 Diagram is not to scale

- NOTES:**
1. Antenna designed to be mounted on plastic cover.
 2. Area in blue above indicates Keep Out Area.
 3. For more information please call TE.

Approx. Dimensions

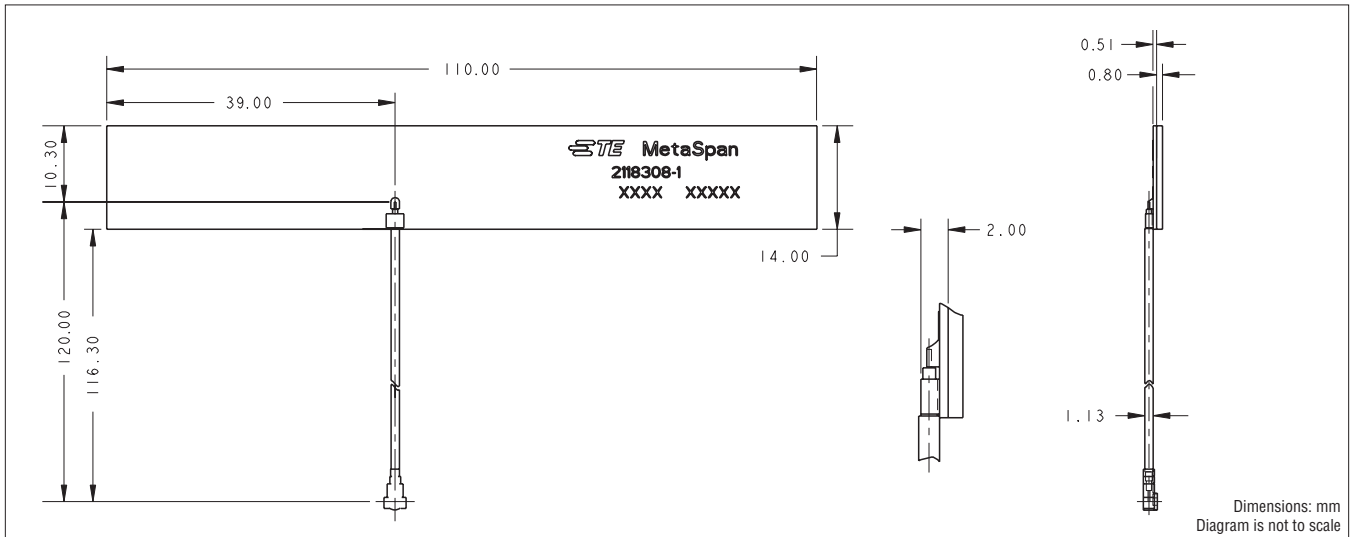

Dimensions: mm
 Diagram is not to scale

© 2014 TE Connectivity family of companies. All Rights Reserved.

1-1773726-2-CSD-PDF-02-14

MetaSpan, TE (logo), and TE Connectivity are trademarks.

Other logos, products and company names mentioned herein may be trademarks of their respective owners.

While TE has made every reasonable effort to ensure the accuracy of the information in this catalog, TE does not guarantee that it is error-free, nor does TE make any other representation, warranty or guarantee that the information is accurate, correct, reliable or current. TE reserves the right to make any adjustments to the information contained herein at any time without notice. TE expressly disclaims all implied warranties regarding the information contained herein, including, but not limited to, any implied warranties of merchantability or fitness for a particular purpose. The dimensions in this catalog are for reference purposes only and are subject to change without notice. Specifications are subject to change without notice.

Consult TE for the latest dimensions and design specifications.

9565 Soquel Drive
 Aptos, CA 95003
 (+ 831) 662-1174
www.antenna.te.com