

## Description

One, two and three pole thermal-magnetic circuit breakers with tripping mechanism and toggle actuation (S-type TM CBE to EN 60934/IEC 934). Designed for panel or plug-in mounting. Available with auxiliary contacts (1 x N/O, 1 x N/C) for status signalling. Two and three pole models are internally linked to ensure that both/all poles trip in the event of an overload on one pole, even if the actuator is held in the ON position. A choice of characteristic curves further extends the range of applications possibilities for these CBEs. Special auxiliary contact versions for industrial atmosphere and low voltages (e. g. 5 V) available on request.

Approved to CBE standard EN 60934 (IEC 60934).

Suitable for use in distribution rails – see section Power Distribution Systems.

## Typical applications

Process control equipment, robotics, machine tool control, communications systems, instrumentation, rail vehicles. Special versions, e.g. for aggressive environmental conditions and low voltages (e. g. 5 V) on request.

## Standard current ratings and typical internal resistance values

Current rating (A)	Internal resistance (Ω)				
	F1	F2	M1	T1	M3
	fast acting for DC only	fast acting delay for AC+DC	standard for AC+DC	delayed low resistance only for AC	standard delay
0.1	162	162	92	81	-
0.2	39.3	39.3	26.1	24.2	-
0.3	17.5	17.5	11.6	10.4	-
0.4	9.2	9.2	6.6	6.0	-
0.5	6.8	6.8	4.1	3.9	-
0.6	4.2	4.2	3	2.7	-
0.8	2.8	2.8	1.65	1.53	-
1	1.6	1.6	1.10	0.98	0.5
1.5	0.78	0.78	0.47	0.42	0.22
2	0.42	0.42	0.28	0.24	0.136
2.5	0.26	0.26	0.183	0.17	0.083
3	0.18	0.18	0.124	0.12	0.057
4	0.12	0.12	0.077	0.073	0.041
5	0.092	0.092	0.063	0.055	0.032
6	0.054	0.054	0.045	0.039	0.021
8	0.025	0.025	≤ 0.02	≤ 0.02	≤ 0.02
10	0.022	0.02	≤ 0.02	≤ 0.02	≤ 0.02
12	≤ 0.02	≤ 0.02	≤ 0.02	≤ 0.02	≤ 0.02
16	≤ 0.02	≤ 0.02	≤ 0.02	≤ 0.02	≤ 0.02
20	-	-	≤ 0.02	≤ 0.02	-
25	-	-	≤ 0.02	≤ 0.02	-

## Preferred types

Preferred types	Standard current ratings (A)						
	1	2	4	6	8	10	16
1-pole:							
2210-S211-P1F1-H111-	x	x	x	x	x		
2210-S211-P1M1-H111-	x	x	x	x	x	x	x
2210-S211-P1M1-Z111-	x	x	x	x	x	x	x
2-pole:							
2210-S221-P1M1-H111-	x	x	x	x	x	x	x
2210-S221-P1M1-H211-	x	x	x	x	x	x	x



2210-S2..

## Technical data

For further details please see: [http://www.e-t-a.de/ti\\_e](http://www.e-t-a.de/ti_e)

Voltage rating	AC 250 V*; 3 AC 433 V (50-60Hz); DC 65 V (*UL: AC 277/480 V; DC 65 V)	
Current rating range	0.1...25 A for curves M1, T1 0.1...16 A for curves F1, F2 1...16 A for curves M3	
Auxiliary circuit	1 A, AC 240 V/DC 65 V, resistive (min. 10 V / 10 mA)	
Typical life	10,000 operations at 1 x I <sub>N</sub> , inductive	
Ambient temperature	-30...+60 °C (-22...+140 °F) T 60	
Insulation co-ordination (IEC 60664 and 60664A)	rated impulse withstand voltage 2.5 kV	pollution degree 2
	reinforced insulation in operating area	
Dielectric strength (IEC 60664 and 60664A)	test voltage	
	operating area AC 3,000 V	
	main/aux. circuit AC 1,500 V	
	aux. circuit 11-12/23-24 AC 1,000 V	
	pole/pole AC 1,500 V	
Insulation resistance	> 100 MΩ (DC 500 V)	
Interrupting capacity I <sub>cn</sub>	0.1...5 A 400 A 6...25 A 800 A	
curves F1, F2, M1, T1:	0.1...16 A 2,500A	(at DC 32 V)
curve M3:	1...2 A AC 200 A	DC 400 A
Interrupting capacity (UL 1077)		
I <sub>N</sub>	0.1...16 A	20...25 A
AC 277 V 1-pole	5,000 A	2,000 A
AC 277/480 V 2-/3-pole	5,000 A	2,000 A
DC 65 V	2,000 A	2,000 A
Degree of protection (IEC 60529/DIN 40050)	operating area IP30 terminal area IP00	
Vibration	<b>curves F1, F2:</b> 3 g (57-500 Hz), ± 0.23 mm (10-57 Hz) <b>curves M1, M3, T1:</b> 5 g (57-500 Hz), ± 0.38 mm (10-57 Hz) to IEC 60068-2-6, test Fc 10 frequency cycles/axis	
Shock	<b>curves F1, F2:</b> 25 g (11 ms), directions 1, 2, 3, 4, 5 10 g (11 ms), direction 6 <b>curves M1, M3, T1:</b> 25 g (11 ms), directions 1, 2, 3, 4, 5 20 g (11 ms), direction 6 to IEC 60068-2-27, test Ea	
Corrosion	96 hours in 5 % salt mist to IEC 60068-2-11, test Ka	
Humidity	240 hours at 95 % RH to IEC 60068-2-78, test Cab	
Mass	approx. 50 g per pole	



## Internal connection diagrams

**with auxiliary contact function 1** (one each N/O and N/C)  
 (...-H111-...) without intermediate position  
 (...-Z111-...) with intermediate position

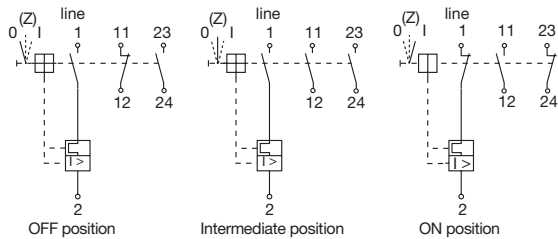

**with auxiliary contact function 4** (1 N/O, leading)

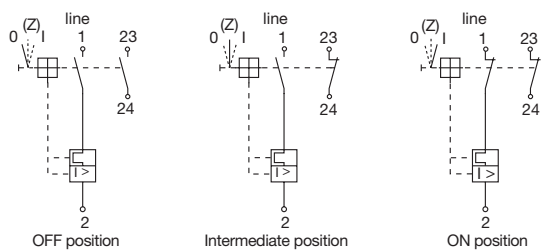

## Toggle positions

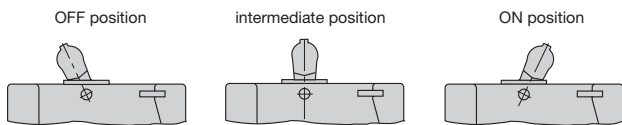

## Shock directions

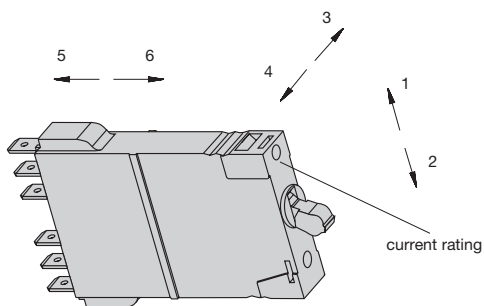

## Typical time/current characteristics

**-F1 0.1...16 A DC only**

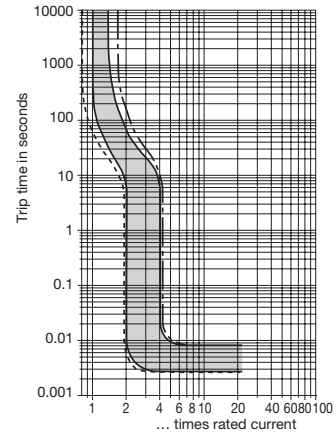

**-F2 0.1...7.5 A AC/DC<sup>1)</sup>**

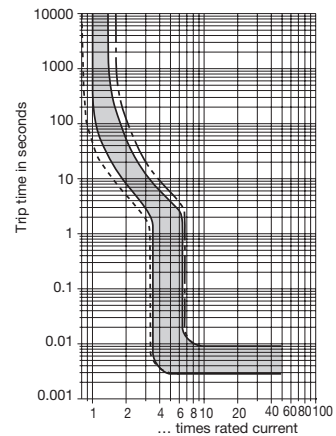

**-F2 8...16 A AC/DC<sup>1)</sup>**

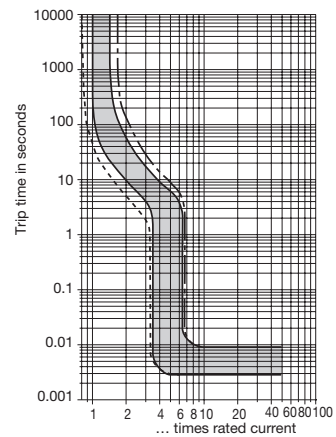

--- +60 °C +140 °F    ——— +23 °C +73.4 °F    - - - -30 °C -22 °F

<sup>1)</sup>Magnetic tripping currents are increased by 30 % on DC supplies.

Multipole devices: all poles symmetrically loaded. With single pole overload, thermal tripping will be at max.  $1.7 \times I_N$  with curves F1, F2 and M1 at max.  $2.2 \times I_N$  with curve M3.

The time/current characteristic curve depends on the ambient temperature prevailing. In order to eliminate nuisance tripping, please multiply the circuit breaker current ratings by the derating factor shown below. See also section Technical information.

Ambient temp.	-22 °F -30 °C	-4 °F -20 °C	+14 °F -10 °C	+32 °F 0 °C	+73.4 °F +23 °C	+86 °F +30 °C	+104 °F +40 °C	+122 °F +50 °C	+140 °F +60 °C
Derating factor	0.76	0.79	0.83	0.88	1	1.04	1.11	1.19	1.29

## Typical time/current characteristics

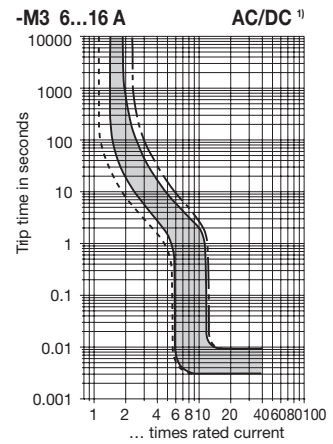
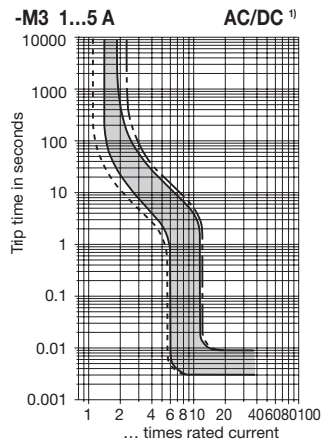
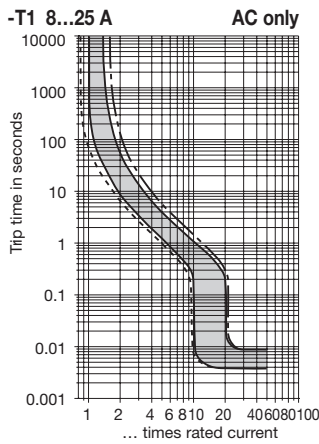
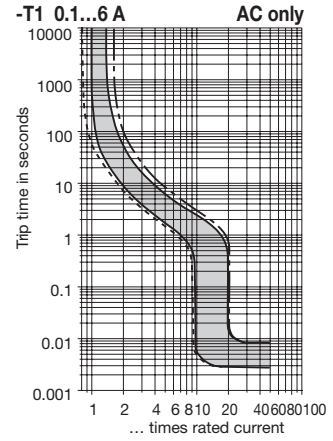
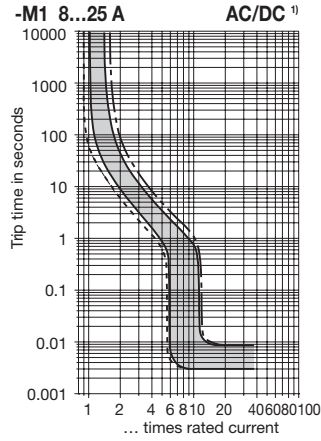
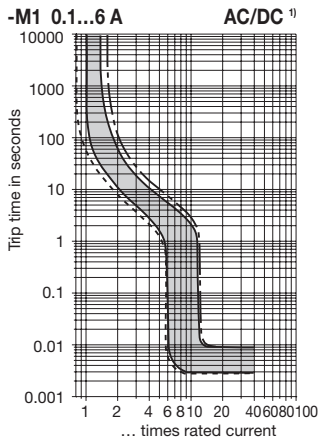

The time/current characteristic curve depends on the ambient temperature prevailing. In order to eliminate nuisance tripping, please multiply the circuit breaker current ratings by the derating factor shown below. See also section Technical information.

Ambient temp.	-22 °F -30 °C	-4 °F -20 °C	+14 °F -10 °C	+32 °F 0 °C	+73.4 °F +23 °C	+86 °F +30 °C	+104 °F +40 °C	+122 °F +50 °C	+140 °F +60 °C
Derating factor	0.76	0.79	0.83	0.88	1	1.04	1.11	1.19	1.29

Multi pole devices: all poles symmetrically loaded. With single pole overload, thermal tripping will be at max.  $1.7 \times I_N$  with curves F1, F2 and M1 at max.  $2.2 \times I_N$  with curve M3.

<sup>1)</sup> Magnetic tripping currents are increased by 30% on DC supplies (curves F2, M1, M3).

