

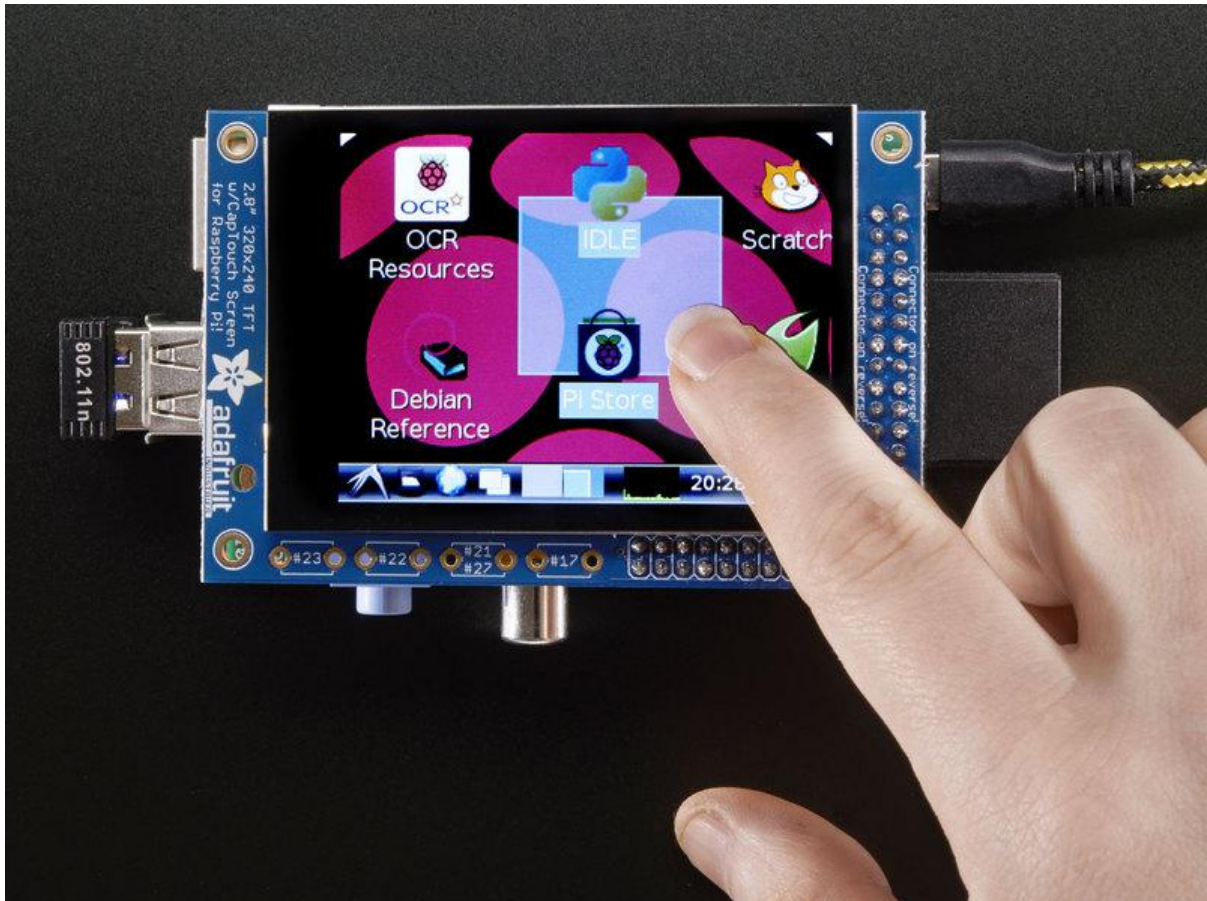

# Adafruit 2.8" PiTFT - Capacitive Touch

Created by lady ada



<https://learn.adafruit.com/adafruit-2-8-pitft-capacitive-touch>

Last updated on 2021-11-15 06:15:43 PM EST

# Table of Contents

Overview	5
Assembly	8
Easy Install	9
• Install Raspberry Pi OS on an SD Card	9
• Installer script	10
• Easy Single Command Install Options	11
• Interactive Installation	13
• Configuring what shows where	14
• PiTFT as Text Console (best for Raspberry Pi OS 'Lite')	14
• PiTFT as HDMI Mirror (Best for Raspberry Pi OS with Desktop)	15
• PiTFT as Raw Framebuffer Device	16
• Creating Your Own Automated Command	16
• Uninstalling The Driver	18
• Unsupported Full Images	18
• PiTFT 2.2" Images	18
• PiTFT 2.4"/2.8"/3.2" Resistive Images	18
• PiTFT 2.8" Capacitive	19
• PiTFT 3.5" Images	19
Capacitive Touchscreen Configuration	19
• If you are running EP0110M09 driver	20
• If you are running FT6236 driver	21
• If you are running FT6X06 driver	21
• Event Testing	22
• AutoMagic Calibration Script	23
• TSLIB calibration	23
• X11 Calibration	24
Console Configuration	24
• Turn off Console Blanking	27
• Raspbian Jessie	27
• Raspbian Wheezy	27
Playing Videos	28
• How To Play Videos	28
• Converting/Resizing Videos	30
Displaying Images	32
Using FBCP	34
Backlight Control	35
Extras!	36
• Making it easier to click icons in X	36
• Right-click on a touchscreen	37
Gesture Input	38
• Installation	38

• Usage	39
<b>PiTFT PyGame Tips</b>	<b>41</b>
• Install pip & pygame	41
• Ensure you are running SDL 1.2	42
• Using the Capacitive touch screen in PyGame	44
<b>F.A.Q.</b>	<b>44</b>
<b>Downloads</b>	<b>45</b>
• Files	45
• Schematic for Pi 1 Version	45
• Schematic for PiTFT Plus (B+/Pi 2 shape)	46
• Fabrication Print (Pi 1 Version)	46
• Fabrication Print (B+/Pi 2 Version)	47



---

# Overview



Our best-selling PiTFT just got a fancy upgrade, now we have a version with a capacitive touchscreen! That's right, instead of a resistive touchscreen, which requires a fingernail or stylus, you can now use a fingerpad. The screen looks much nicer, with a black bezel and glass overlay.

Featuring a 2.8" display with 320x240 16-bit color pixels and a capacitive touch overlay. The plate uses the high speed SPI interface on the Pi and can use the mini display as a console, X window port, displaying images or video etc. Best of all it plugs right in on top!

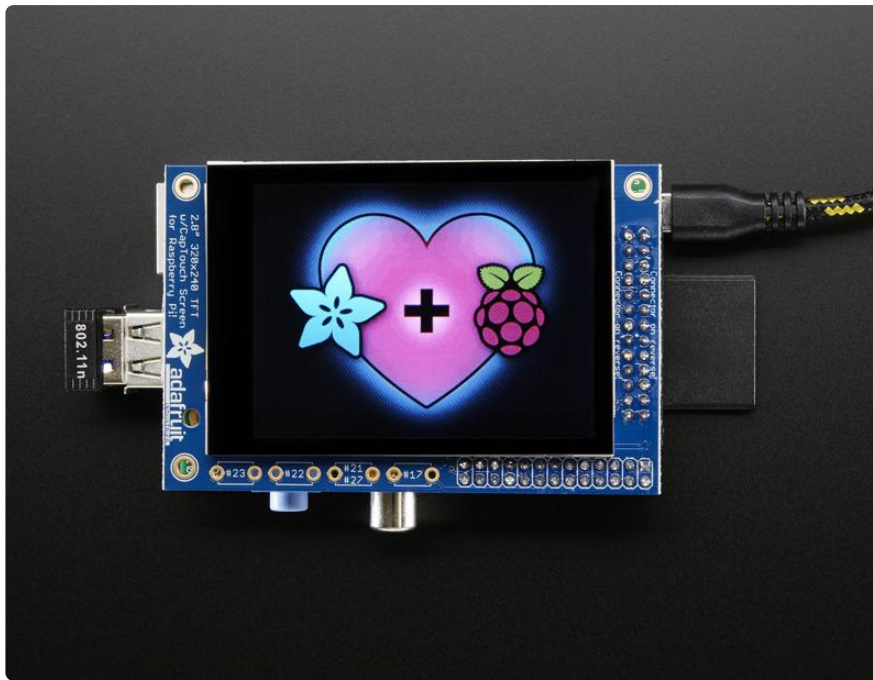

Uses the hardware I2C Pins (SDA & SCL), SPI pins (SCK, MOSI, MISO, CE0) as well as GPIO #25 and #24. All other GPIO are unused. Since we had a tiny bit of space, there's 4 spots for optional slim tactile switches wired to four GPIOs, that you can use if you want to make a basic user interface. For example, you can use one as a power on/off button. See below for the link to get the optional tact switches, they're not included.

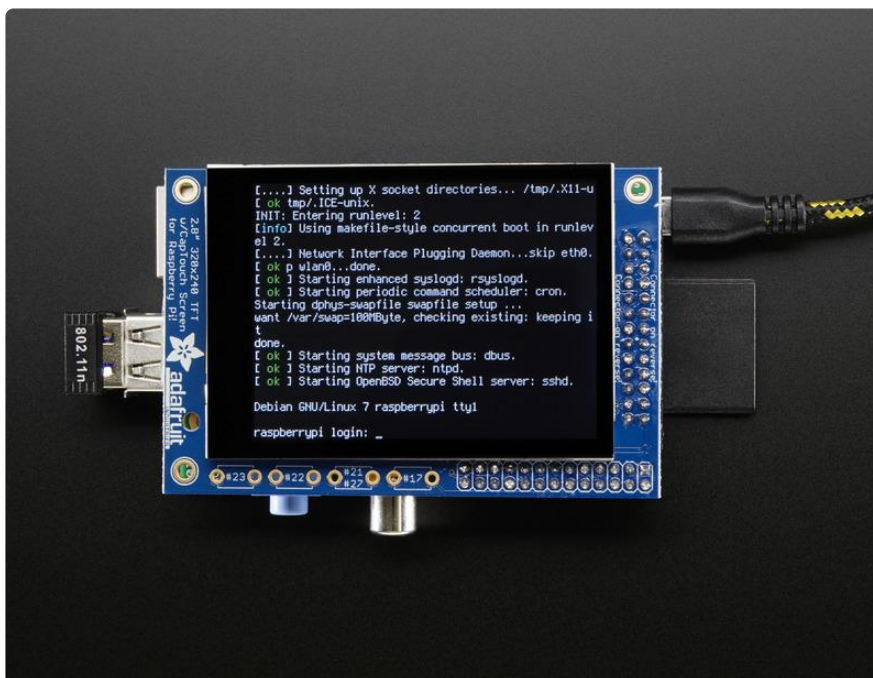

The screen is the same size as the resistive type so you can use this with the PiTFT PiBow or any other enclosure you may already have. We also use the same SDL device and signals so PyGame and X11 based programs can be swapped in with no changes in code.



It's designed to fit nicely onto the Pi Model A or B rev 2 but also works perfectly fine with the Model B+ as long as you don't mind the PCB overhangs the USB ports by 5mm, see the photos above. Model B rev 1 have an older layout for the I2C pins and won't be able to use the touch screen

This version comes as a mini-kit, with a 2x13 extra-tall female header (to connect the plate to the Pi) and a 2x13 male header that can be used to connect an IDC cable or cobbler from the side. The photos above also show the optional installed slim tactile buttons. [The tactile buttons are not included, but you can pick up a pack of 20 here. \(http://adafru.it/1489\)](http://adafru.it/1489) Some basic soldering is required to install the headers. [You can also pick up an extra-long Pi stacking header if you want to install that instead of the 2x13 female header installed. \(http://adafru.it/1112\)](http://adafru.it/1112)

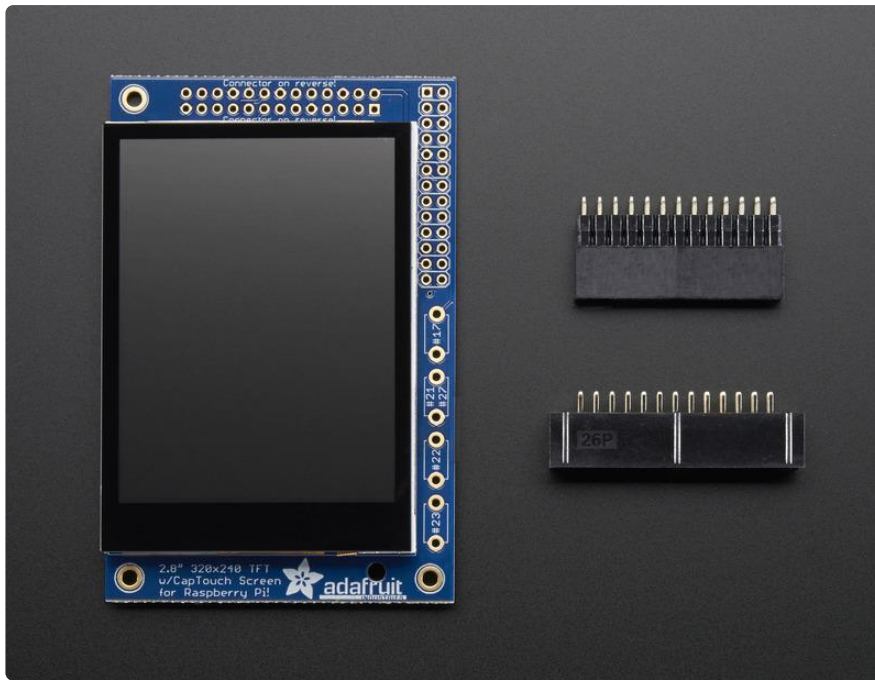

## Assembly

We are now selling these displays pre-assembled - skip this step if your PiTFT is not a mini-kit

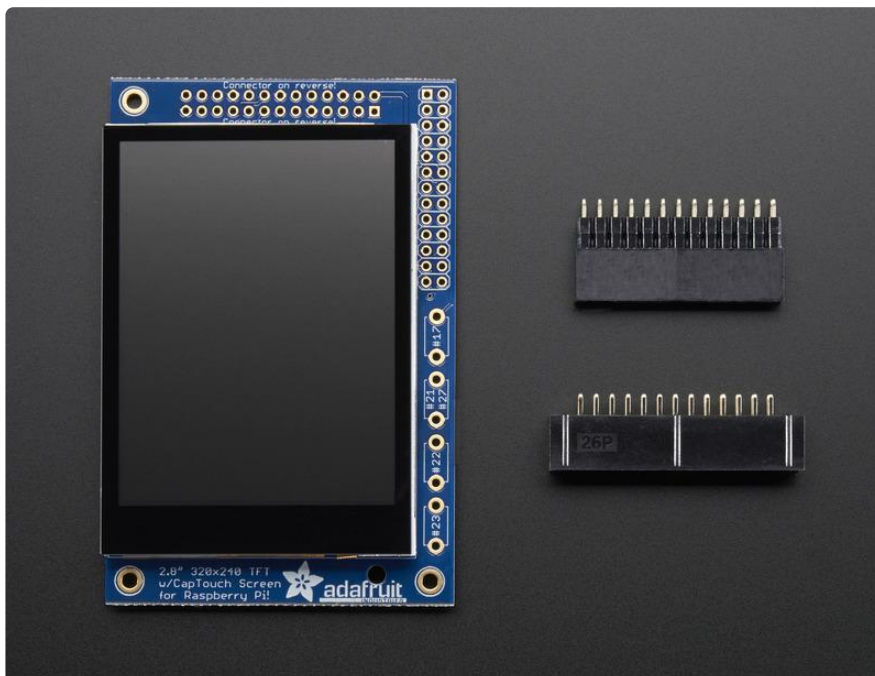

This section is identical to the PiTFT Resistive 2.8" so please visit that page to complete assembly of this Pi Plate



Visit the 2.8" Resistive PiTFT  
Assembly Page

<https://adafru.it/dDQ>

## Easy Install



The PiTFT requires some device tree support and a couple other things to make it a nice stand-alone display. If you just want to get going, check out the following for easy-install instructions!

The same installer is used for all PiTFTs, you will pick and configure the setup during installation!

## Install Raspberry Pi OS on an SD Card

You'll need to start with Raspberry Pi OS or Raspberry Pi OS Lite.

The last known for-sure tested-and-working version is May 28, 2021 ([https://downloads.raspberrypi.org/raspios\\_lite\\_armhf/images/raspios\\_lite\\_armhf-2021-05-28/](https://downloads.raspberrypi.org/raspios_lite_armhf/images/raspios_lite_armhf-2021-05-28/) (<https://adafru.it/VGE>)) from [https://downloads.raspberrypi.org/raspios\\_lite\\_armhf/images/](https://downloads.raspberrypi.org/raspios_lite_armhf/images/) (<https://adafru.it/VHb>)

Raspberry Pi OS does often 'break' stuff when new versions come out so to be safe, if you are having problems try this version!

The latest Raspberry Pi Bullseye release is new and may have issues with the PiTFT. In that case, you can try the previous buster release.

## Installer script

This script will do all the work for you, and install both device tree overlay support as well as configure rotation and any HDMI mirroring. PiTFT no longer needs any custom kernels or modules, so you can continue to update/upgrade your Pi and it will work with the most recent releases.

Here's the commands to run. Make sure your Pi has network access, it needs to download the software!

The latest installer script was rewritten in Python, so it can be installed with just a few commands. First, start by installing a few dependencies and downloading the repo:

```
cd ~
sudo apt-get install -y git python3-pip
sudo pip3 install --upgrade adafruit-python-shell click
git clone https://github.com/adafruit/Raspberry-Pi-Installer-Scripts.git
cd Raspberry-Pi-Installer-Scripts
```

```
pi@raspberrypi:~ $ cd ~
pi@raspberrypi:~ $ sudo pip3 install --upgrade adafruit-python-shell click==7.0
Looking in indexes: https://pypi.org/simple, https://www.piwheels.org/simple
Collecting adafruit-python-shell
  Using cached https://www.piwheels.org/simple/adafruit-python-shell/adafruit_py
thon_shell-1.2.1-py3-none-any.whl
Collecting click==7.0
  Using cached https://files.pythonhosted.org/packages/fa/37/45185cb5abbc30d7257
104c434fe0b07e5a195a6847506c074527aa599ec/Click-7.0-py2.py3-none-any.whl
Requirement already satisfied, skipping upgrade: clint in /usr/local/lib/python3
.7/dist-packages (from adafruit-python-shell) (0.5.1)
Requirement already satisfied, skipping upgrade: Adafruit-PlatformDetect in /usr
/local/lib/python3.7/dist-packages (from adafruit-python-shell) (2.17.0)
Requirement already satisfied, skipping upgrade: args in /usr/local/lib/python3.
7/dist-packages (from clint->adafruit-python-shell) (0.1.0)
Installing collected packages: adafruit-python-shell, click
Successfully installed adafruit-python-shell-1.2.1 click-7.0
pi@raspberrypi:~ $ sudo apt-get install -y git
Reading package lists... Done
Building dependency tree
Reading state information... Done
Suggested packages:
  git-daemon-run | git-daemon-sysvinit git-doc git-el git-email git-gui gitk
  gitweb git-cvs git-mediawiki git-svn
```

## Easy Single Command Install Options

The latest script allows you to specify all of your options within the command so you can sit back and watch the installation. We'll cover interactive installation below if you want to answer each prompt for a customized installation.

### Console Install Commands

If you just want a console to appear on the display, you will want to use the following commands:

For the PiTFT 2.4", 2.8", or 3.2" Resistive touchscreens, use the following command:

```
sudo python3 adafruit-pitft.py --display=28r --rotation=90 --install-type=console
```

For the PiTFT 2.8" Capacitive touchscreen, use the following command:

```
sudo python3 adafruit-pitft.py --display=28c --rotation=90 --install-type=console
```

For the PiTFT 2.2" Display, use the following command:

```
sudo python3 adafruit-pitft.py --display=22 --rotation=90 --install-type=console
```

For the PiTFT 3.5" Resistive touchscreen, use the following command:

```
sudo python3 adafruit-pitft.py --display=35r --rotation=90 --install-type=console
```

For the Mini PiTFT 1.3", BrainCraft HAT, 1.3" Color TFT Bonnet, or 1.5" Display, use the following command:

```
sudo python3 adafruit-pitft.py --display=st7789_240x240 --rotation=0 --install-type=console
```

For the Mini PiTFT 1.14" Display, use the following command:

```
sudo python3 adafruit-pitft.py --display=st7789_240x135 --rotation=270 --install-type=console
```

## FBCP Install Commands

If you just want to mirror the HDMI output to the display, which is known as FrameBuffer Copy or FBCP for short, you will want to use the following commands:

For the PiTFT 2.4", 2.8", or 3.2" Resistive touchscreens, use the following command:

```
sudo python3 adafruit-pitft.py --display=28r --rotation=90 --install-type=fbcp
```

For the PiTFT 2.8" Capacitive touchscreen, use the following command:

```
sudo python3 adafruit-pitft.py --display=28c --rotation=90 --install-type=fbcp
```

For the PiTFT 2.2" Display, use the following command:

```
sudo python3 adafruit-pitft.py --display=22 --rotation=90 --install-type=fbcp
```

For the PiTFT 3.5" Resistive touchscreen, use the following command:

```
sudo python3 adafruit-pitft.py --display=35r --rotation=90 --install-type=fbcp
```

For the Mini PiTFT 1.3", BrainCraft HAT, 1.3" Color TFT Bonnet, or 1.5" Display, use the following command:

```
sudo python3 adafruit-pitft.py --display=st7789_240x240 --rotation=0 --install-type=fbcp
```

For the Mini PiTFT 1.14" Display, use the following command:

```
sudo python3 adafruit-pitft.py --display=st7789_240x135 --rotation=270 --install-type=fbcp
```

## Rebooting

When it asks you to reboot, then choose yes because the setting won't take full effect until you do so.

```
removing old section...
##### UPGRADING KERNEL #####
Updating packages...
Installing Kernel Headers...
PITFT make: Entering directory '/usr/src/linux-headers-5.4.51-v7l+'
PITFT Building modules, stage 2.
PITFT MODPOST 2 modules
PITFT LD [M] /home/pi/Raspberry-Pi-Installer-Scripts/st7789_module/fb_st7789v.ko
PITFT LD [M] /home/pi/Raspberry-Pi-Installer-Scripts/st7789_module/st7789v_ada.ko
PITFT make: Leaving directory '/usr/src/linux-headers-5.4.51-v7l+'
PITFT Success!

Settings take effect on next boot.
REBOOT NOW? [Y/n] y
```

## Interactive Installation

For an interactive install, you can just run the script without any options:

```
sudo python3 adafruit-pitft.py
```

Once you run it you will be presented with menus for configuration.

## Display Selection

Start by selecting the board that best corresponds with your PiTFT. There's lots of options and we will likely be adding more in the future.

```
This script downloads and installs
PiTFT Support using userspace touch
controls and a DTO for display drawing.
one of several configuration files.
Run time of up to 5 minutes. Reboot required!

Select configuration:
[1] PiTFT 2.4", 2.8" or 3.2" resistive (240x320) (320x240)
[2] PiTFT 2.2" no touch (320x240)
[3] PiTFT 2.8" capacitive touch (320x240)
[4] PiTFT 3.5" resistive touch (480x320)
[5] PiTFT Mini 1.3" or 1.54" display (240x240) - WARNING! WILL UPGRADE YOUR KERNEL TO LATEST
[6] ST7789V 2.0" no touch (320x240) - WARNING! WILL UPGRADE YOUR KERNEL TO LATEST
[7] MiniPiTFT 1.14" display (240x135) - WARNING! WILL UPGRADE YOUR KERNEL TO LATEST
[8] Uninstall PiTFT
[9] Quit without installing
```

## Rotation

Next you will be asked for the rotation you want, don't worry if you're not 100% sure which you want, you can always change this later by re-running the script

```
Select rotation:
[1] 90 degrees (landscape)
[2] 180 degrees (portrait)
[3] 270 degrees (landscape)
[4] 0 degrees (portrait)
```

It will take a few minutes to install the software and download all the things...

```
Select rotation:
[1] 90 degrees (landscape)
[2] 180 degrees (portrait)
[3] 270 degrees (landscape)
[4] 0 degrees (portrait)
1
PITFT Checking init system...
Found system
/boot is mounted
PITFT System update
Updating apt indexes.....
Reading package lists...
.....
PITFT Installing Python libraries & Software...
Installing Pre-requisite Software...This may take a few minutes!
```

## Configuring what shows where

You have a few different ways to set up the PiTFT, we ask 2 questions to figure out what you want

### PiTFT as Text Console (best for Raspberry Pi OS 'Lite')

This is the simplest to set-up type of use. Its great if you have a simple text based or pygame/SDL based interface. If you want the PiTFT to act as a text console you can expect:

- HDMI will be 'deactivated' - nothing appears on the HDMI output but a black screen
- The login prompt appears on the Pi
- The Pi is all text, not a GUI (no PIXEL desktop)
- Keyboard and mouse are used only by the PiTFT interface
- Framebuffer-capable software (such as fbi for displaying images, mplayer for videos, or pygame software, etc) appear on the PiTFT
- OpenGL accelerated software will not appear on the PiTFT (it is unaccelerated framebuffer only)
- But, non-OpenGL-accelerated graphics software is a bit faster than using HDMI mirroring (not tons faster but you're not running fbcp which will always make it faster)

If you want that, say Yes to the question **Would you like the console to appear on the PiTFT display**

```
PiTFt python-pip is already the newest version (18.1-5+rpt1).
PiTFt python-spidev is already the newest version (20190221~182651-1).
PiTFt 0 upgraded, 0 newly installed, 0 to remove and 0 not upgraded.
PiTFt Looking in indexes: https://pypi.org/simple, https://www.piwheels.org/simple
PiTFt Requirement already satisfied: evdev in /usr/local/lib/python3.7/dist-packages (1.3.0)
PiTFt Updating /boot/config.txt...
Already have an adafruit-pitft-helper section in /boot/config.txt.
Removing old section...
PiTFt Updating SysFS rules for Touchscreen...
PiTFt Updating tslib default calibration...
Would you like the console to appear on the PiTFT display? [y/n]
```

Then simply reboot. Once rebooted you will not see anything on HDMI, but the console will appear on the PiTFT. That's it!

## PiTFT as HDMI Mirror (Best for Raspberry Pi OS with Desktop)

This option is the easiest to understand: whatever appears on the HDMI display will be 'mirrored' to the PiTFT. Note that HDMI is much higher resolution so it's not like it turns the PiTFT into a 1080p display. This is great for when you want to run OpenGL-optimized software, PIXEL desktop software, or really anything. The down-side is it's a little slower than drawing directly to the framebuffer. You may not notice it but it's worth us mentioning!

- HDMI will be 'activated' but at a lower resolution - you can change this later but it looks best at 320x240 (PiTFT 2.2", 2.4", 2.8" and 3.2") or 480x320 (PiTFT 3.5")
- The login prompt or GUI appears on both HDMI and PiTFT at the same time
- Keyboard and mouse are shared, since the display is mirrored
- All graphics appear on both HDMI and PiTFT, thanks to fbcp

If you want that, say Yes to the question **Would you like the HDMI display to mirror to the PiTFT display?**

```
PiTFt Making sure console doesn't use PiTFT
Removing console fbcon map from /boot/cmdline.txt
Screen blanking time reset to 10 minutes
Would you like the HDMI display to mirror to the PiTFT display? [y/n]
```

## PiTFT as Raw Framebuffer Device

For advanced users who are comfortable using framebuffer devices, it is possible to have the PiTFT and HDMI graphics be both active and display different data.

- HDMI will be active and act like a normal Pi
- The login prompt or GUI (PIXEL) appears on the HDMI
- PiTFT appears black, nothing appears on it
- Keyboard and mouse are used by the HDMI interface but can, in theory, be captured and used to change graphics on PiTFT through programming
- Framebuffer-capable software (such as fbi for displaying images, mplayer for videos, or pygame software, etc) can appear on the PiTFT if you set it up to display to /dev/fb1
- OpenGL accelerated software will never appear on the PiTFT (it is unaccelerated framebuffer only)

If you want that, say No to both of the configuration questions!

You can always change your mind after setting up one of the configurations, depending on your needs! Just re-run the script

## Creating Your Own Automated Command

Under the Easy Single Command Install Options section, there are a bunch of different installation flags that you can choose between. If you want to create your own command, you can find the latest options by typing:

```
sudo python3 adafruit-pitft.py --help
```

```
pi@raspberrypi:~/Raspberry-Pi-Installer-Scripts $ sudo python3 adafruit-pitft.py
--help
Usage: adafruit-pitft.py [OPTIONS]

Options:
  -v, --version          Print version information
  -u, --user TEXT        Specify path of primary user's home
                        directory [default: /home/pi]
  --display TEXT         Specify a display option (1-7) or type
                        ['28r', '22', '28c', '35r',
                        'st7789_240x240', 'st7789_240x320',
                        'st7789_240x135']
  --rotation INTEGER     Specify a rotation option (1-4) or degrees
                        (0, 90, 180, 270)
  --install-type [fbcp|console|uninstall]
                        Installation Type
  --reboot [yes|no]      Specify whether to reboot after the script
                        is finished
  --help                 Show this message and exit.
```



The main options to pay attention to are the `--display`, `--rotation`, and `--install-type` arguments.

For the display, you can either choose the number you type for the options or the display type, which has the options listed under help. For instance, to use the 2.8" Resistive display you could use

```
--display=1 or --display=28r
```

For the rotation, you can either choose the number you type for the options or the angle, which has the options also listed under help. To use 90 degrees, you could use

```
--rotation=1 or --rotation=90
```

For install type, You can either choose fbcpl, console or uninstall. To use FBCP, you would simply supply

```
--install-type=fbcpl
```

## Automated Reboot Option

To go with a fully automated installation, you can provide a `--reboot` flag. To always reboot, use:

```
--reboot=yes
```

This is useful if you want to use the display right after running the script. To never reboot immediately, use

```
--reboot=no
```

This is useful if you want it as part of a larger script that installs many things.

## Custom User Directory

By default, it is installed under the current user directory, but you can provide the `-u` or `--user` flag along with the folder that you want to install to.

## Uninstalling The Driver

To uninstall, you would either run the script interactively and choose Uninstall or you can provide the uninstall flag:

```
--install-type=uninstall
```

## Unsupported Full Images

Historically, we provided full 'images' of Raspbian, which is now called Raspberry Pi OS. This worked OK until Raspbian started doing releases every few months. These are no longer supported, and won't even boot on Pi 3B+, so we recommend the script above.

There's the larger 'classic Jessie' image that will boot into X by default, and requires a 8G image, it has a lot more software installed. There's also the smaller 'Jessie Lite' that will boot into the command line, and can be burned onto a 2G card! Click below to download and install into a new SD card. [Unzip and follow the classic SD card burning tutorials \(https://adafru.it/aMW\)](https://adafru.it/aMW)

## PiTFT 2.2" Images

- [Raspbian Jessie 2016/10/23-based image \(https://adafru.it/sbg\)](https://adafru.it/sbg)
- [Raspbian Jessie Lite 2016/10/23-based image \(https://adafru.it/sbh\)](https://adafru.it/sbh)
- [Raspbian Jessie 2016/03/25-based image \(https://adafru.it/mAe\)](https://adafru.it/mAe)
- [Raspbian Jessie Lite 2016/03/25-based image \(https://adafru.it/mAf\)](https://adafru.it/mAf)
- [Raspbian Jessie 2015/09/24-based image \(https://adafru.it/iDC\)](https://adafru.it/iDC)
- [Raspbian Wheezy 2015/09/09-based image \(https://adafru.it/idT\)](https://adafru.it/idT)

## PiTFT 2.4"/2.8"/3.2" Resistive Images

- [Raspbian Jessie 2016/9/23-based image \(https://adafru.it/s7f\)](https://adafru.it/s7f)
- [Raspbian Jessie Lite 2016/9/23-based image \(https://adafru.it/s7A\)](https://adafru.it/s7A)
- [Raspbian Jessie 2016/03/25-based image \(https://adafru.it/mA9\)](https://adafru.it/mA9)
- [Raspbian Jessie Lite 2016/03/25-based image \(https://adafru.it/mAa\)](https://adafru.it/mAa)
- [Raspbian Jessie 2015/09/24-based image \(https://adafru.it/iDA\)](https://adafru.it/iDA)
- [Raspbian Wheezy 2015/09/09-based image \(https://adafru.it/idJ\)](https://adafru.it/idJ)
- [Raspbian 2014/06/20-based image \(https://adafru.it/dSM\)](https://adafru.it/dSM)
- [Raspbian 2014/09/09-based image \(https://adafru.it/e12\)](https://adafru.it/e12)

## PiTFT 2.8" Capacitive

- [Raspbian Jessie 2016-09-23-based image \(https://adafru.it/saM\)](https://adafru.it/saM)
- [Raspbian Jessie Lite 2016-09-23-based image \(https://adafru.it/saN\)](https://adafru.it/saN)
- [Raspbian Jessie 2016-03-25-based image \(https://adafru.it/mAc\)](https://adafru.it/mAc)
- [Raspbian Jessie Lite 2016-03-25-based image \(https://adafru.it/mAd\)](https://adafru.it/mAd)
- [Raspbian Jessie 2015/09/24-based image \(https://adafru.it/iDy\)](https://adafru.it/iDy)
- [Raspbian Wheezy 2015/09/24-based image \(https://adafru.it/idz\)](https://adafru.it/idz)
- [Raspbian 2014/09/18-based image \(https://adafru.it/e11\)](https://adafru.it/e11)
- [Raspbian 2014/06/20-based image \(https://adafru.it/dSO\)](https://adafru.it/dSO)
- [Raspbian image from 2015/03/03 \(https://adafru.it/eUI\)](https://adafru.it/eUI)

## PiTFT 3.5" Images

- [Raspbian Jessie 2016/9/23-based image \(https://adafru.it/siF\)](https://adafru.it/siF)
- [Raspbian Jessie Lite 2016/9/23-based image \(https://adafru.it/sja\)](https://adafru.it/sja)
- [Raspbian Jessie 2016/03/25-based image \(https://adafru.it/mAb\)](https://adafru.it/mAb)
- [Raspbian Jessie 2016/03/25-based image \(https://adafru.it/mAG\)](https://adafru.it/mAG)
- [Raspbian Jessie 2015/09/24-based image \(https://adafru.it/iDD\)](https://adafru.it/iDD)
- [Raspbian Wheezy 2015/09/24-based image \(https://adafru.it/idy\)](https://adafru.it/idy)
- [Raspbian 2014/09/09-based image \(https://adafru.it/e10\)](https://adafru.it/e10)
- [Raspbian 2015/03/12 image \(https://adafru.it/eUE\)](https://adafru.it/eUE)

---

## Capacitive Touchscreen Configuration

If you've grabbed our Easy Install image, or use the script, this step is not required, it's already done! This is just for advanced users who are curious on how to configure and customize the touchscreen

The capacitive touch driver in Raspbian no longer works with "ts\_test" because it doesn't emit 'proper' touchscreen events. It works in LXDE though.



The nifty thing about capacitive touch screens is that they do not require calibration! The calibration is done 'in chip' on the screen itself. However, we still do need to tell the Pi how to read the capacitive chip.

Before we start, we'll make a udev rule for the touchscreen. That's because the event X name of the device will change a lot and its annoying to figure out what its called depending on whether you have a keyboard or other mouse installed.

First up figure out if you have the FT62X6 driver or FT6236 driver by running `dmesg | grep ft6` or `dmesg | grep EP0110M09`

## If you are running EP0110M09 driver

Run

```
sudo nano /etc/udev/rules.d/95-ftcaptouch.rules
```

to create a new udev file and copy & paste the following line in:

```
SUBSYSTEM=="input", ATTRS{name}=="EP0110M09", ENV{DEVNAME}  
=="*event*", SYMLINK+="input/touchscreen"
```

## If you are running FT6236 driver

Run

```
sudo nano /etc/udev/rules.d/95-ft6236.rules
```

to create a new udev file and copy & paste the following line in:

```
SUBSYSTEM=="input", ATTRS{name}=="ft6236", ENV{DEVNAME}  
=="*event*", SYMLINK+="input/touchscreen"
```

## If you are running FT6X06 driver

Run

```
sudo nano /etc/udev/rules.d/95-ft6206.rules
```

to create a new udev file and copy & paste the following line in:

```
SUBSYSTEM=="input", ATTRS{name}=="ft6x06_ts", ENV{DEVNAME}  
=="*event*", SYMLINK+="input/touchscreen"
```

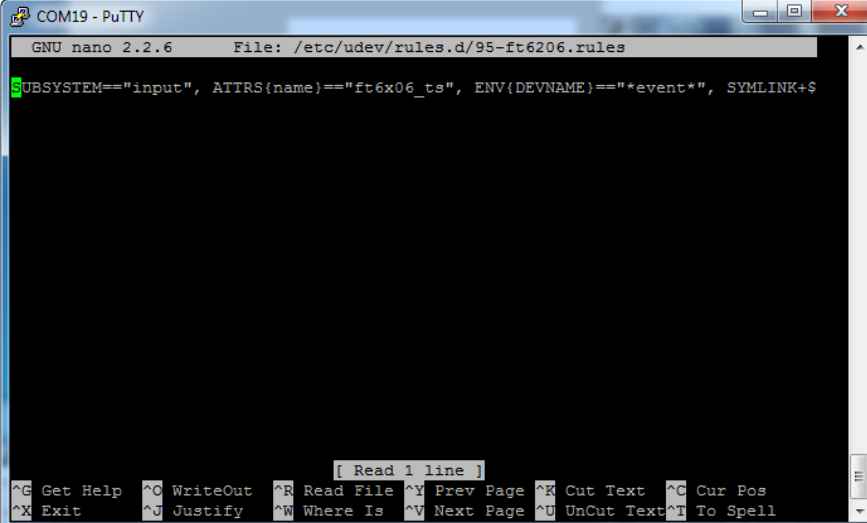
A screenshot of a terminal window titled 'COM19 - PuTTY'. The window shows the GNU nano 2.2.6 editor editing the file '/etc/udev/rules.d/95-ft6206.rules'. The content of the file is: 'SUBSYSTEM=="input", ATTRS{name}=="ft6x06\_ts", ENV{DEVNAME}=="\*event\*", SYMLINK+\$. The terminal has a standard nano editor interface with a status bar at the bottom showing various keyboard shortcuts like '^G Get Help', '^O WriteOut', '^R Read File', '^Y Prev Page', '^K Cut Text', '^C Cur Pos', '^X Exit', '^J Justify', '^W Where Is', '^V Next Page', '^U UnCut Text', and '^T To Spell'. There is also a '[ Read 1 line ]' indicator in the middle of the screen.

Reboot the Pi with `sudo reboot`

Then type `ls -l /dev/input/touchscreen`

It should point to eventX where X is some number, that number will be different on different setups since other keyboards/mice/USB devices will take up an event slot

```
pi@raspberrypi: /etc/udev/rules.d
pi@raspberrypi:/etc/udev/rules.d $ ls -l /dev/input/touchscreen
lrwxrwxrwx 1 root root 6 Oct 12 21:25 /dev/input/touchscreen -> event0
pi@raspberrypi:/etc/udev/rules.d $
```

(<https://adafru.it/dIX>)

# Event Testing

Even though capacitive touch screens don't require calibration, there are some useful tools we can use to debug the touchscreen. Install the "event test" and "touchscreen library" packages with

```
sudo apt-get install evtest tslib libts-bin
```

```
COM3 - PuTTY
pi@raspberrypi:~$
pi@raspberrypi:~$ sudo apt-get install evtest tslib libts-bin
Reading package lists... Done
Building dependency tree
Reading state information... Done
Note, selecting 'libts-0.0-0' instead of 'tslib'
libts-0.0-0 is already the newest version.
The following NEW packages will be installed:
  evtest libts-bin
0 upgraded, 2 newly installed, 0 to remove and 0 not upgraded.
Need to get 0 B/55.0 kB of archives.
After this operation, 219 kB of additional disk space will be used.
Do you want to continue [Y/n]? Y
Selecting previously unselected package libts-bin.
(Reading database ... 62285 files and directories currently installed.)
Unpacking libts-bin (from .../libts-bin_1.0-11_armhf.deb) ...
Selecting previously unselected package evtest.
Unpacking evtest (from .../evtest_1:1.30-1_armhf.deb) ...
Processing triggers for man-db ...
Setting up libts-bin (1.0-11) ...
Setting up evtest (1:1.30-1) ...
pi@raspberrypi:~$
```

Now you can use some tools such as

```
sudo evtest /dev/input/touchscreen
```

which will let you see touchscreen events in real time, press on the touchscreen to see the reports.

```
COM19 - PuTTY
Max 255
Event code 53 (ABS_MT_POSITION_X)
Value 0
Min 0
Max 4095
Event code 54 (ABS_MT_POSITION_Y)
Value 0
Min 0
Max 4095
Event code 57 (ABS_MT_TRACKING_ID)
Value 0
Min 0
Max 2
Event code 58 (ABS_MT_PRESSURE)
Value 0
Min 0
Max 255
Properties:
Testing ... (interrupt to exit)
```

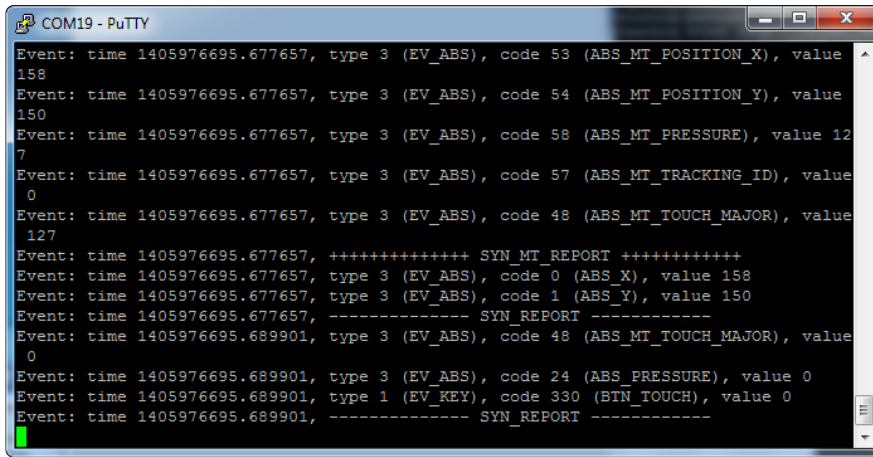

```
COM19 - PuTTY
Event: time 1405976695.677657, type 3 (EV_ABS), code 53 (ABS_MT_POSITION_X), value 158
Event: time 1405976695.677657, type 3 (EV_ABS), code 54 (ABS_MT_POSITION_Y), value 150
Event: time 1405976695.677657, type 3 (EV_ABS), code 58 (ABS_MT_PRESSURE), value 127
Event: time 1405976695.677657, type 3 (EV_ABS), code 57 (ABS_MT_TRACKING_ID), value 0
Event: time 1405976695.677657, type 3 (EV_ABS), code 48 (ABS_MT_TOUCH_MAJOR), value 127
Event: time 1405976695.677657, ++++++ SYN_MT_REPORT ++++++
Event: time 1405976695.677657, type 3 (EV_ABS), code 0 (ABS_X), value 158
Event: time 1405976695.677657, type 3 (EV_ABS), code 1 (ABS_Y), value 150
Event: time 1405976695.677657, ----- SYN_REPORT -----
Event: time 1405976695.689901, type 3 (EV_ABS), code 48 (ABS_MT_TOUCH_MAJOR), value 0
Event: time 1405976695.689901, type 3 (EV_ABS), code 24 (ABS_PRESSURE), value 0
Event: time 1405976695.689901, type 1 (EV_KEY), code 330 (BTN_TOUCH), value 0
Event: time 1405976695.689901, ----- SYN_REPORT -----
```

## AutoMagic Calibration Script

If you rotate the display you need to recalibrate the touchscreen to work with the new screen orientation. You can manually run the calibration processes in the next section, or you can re-run the installer script and select a new rotation:

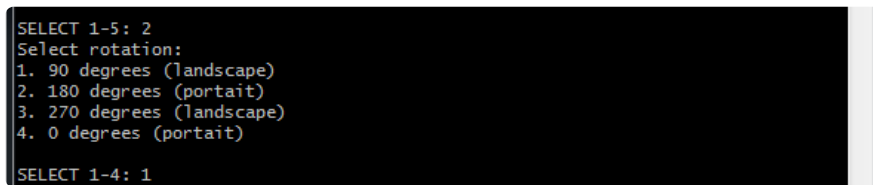

```
SELECT 1-5: 2
Select rotation:
1. 90 degrees (landscape)
2. 180 degrees (portait)
3. 270 degrees (landscape)
4. 0 degrees (portait)
SELECT 1-4: 1
```

Try using this default calibration script to easily calibrate your touchscreen display. Note that the calibration values might not be exactly right for your display, but they should be close enough for most needs. If you need the most accurate touchscreen calibration, follow the steps in the next section to manually calibrate the touchscreen.

## TSLIB calibration

In order to use TSLIB - basically, the touchscreen without X11 - you'll need to set the calibration for TSLIB in `/etc/pointercal`

With a resistive touchscreen, you have to calibrate it. Since capacitive touchscreens don't require calibration you can just input the numbers directly. Run

```
sudo nano /etc/pointercal
```

And enter in the following values (there's a single space between each number) and hit return afterwards. Then save

```
320 65536 0 -65536 0 15728640 65536
```

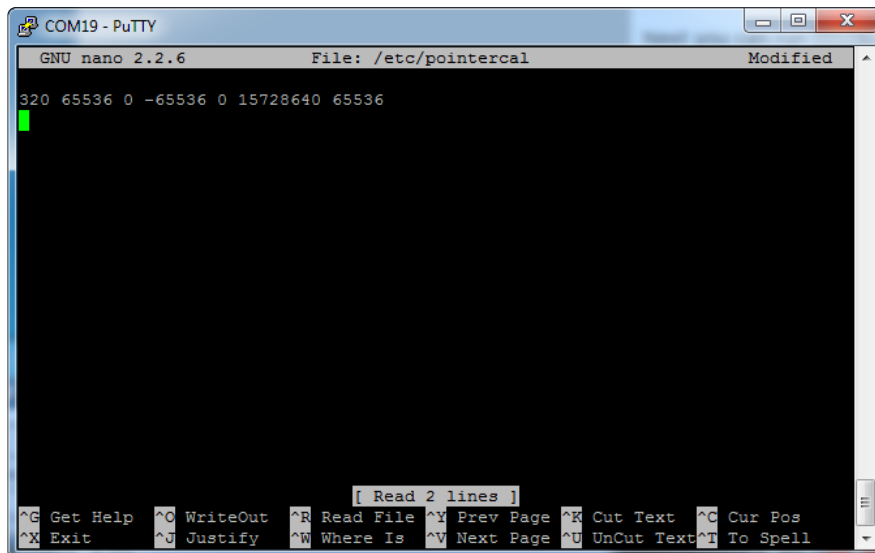

Next you can run

```
sudo TSLIB_FBDEVICE=/dev/fb1 TSLIB_TSDEVICE=/dev/input/touchscreen  
ts_test
```



## X11 Calibration

X11 uses a different calibration system than TSLib/PyGame. [You can see how to run xtcalf here \(https://adafru.it/BFX\)](https://adafru.it/BFX) except use EP0110M09 as the name of the device

## Console Configuration

If you've used our installer script, this step is not required, it's already done! This is just for advanced users who are curious on how to configure and customize the console



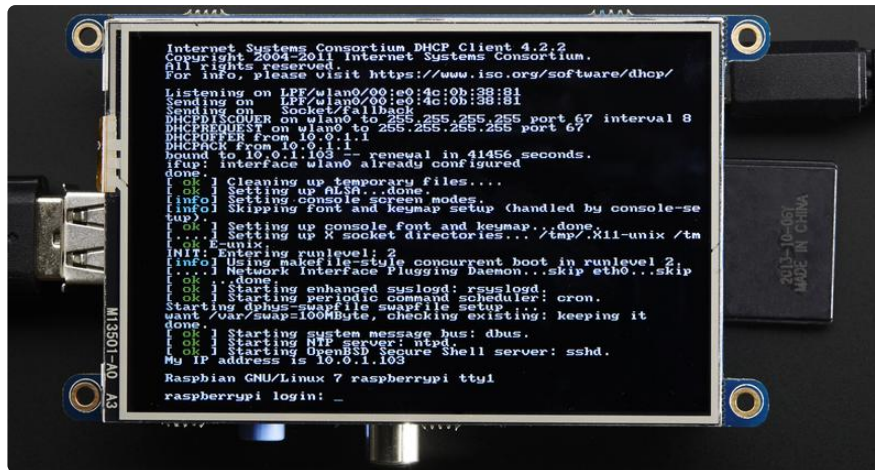

One fun thing you can do with the display is have it as your main console instead of the HDMI/TV output. Even though it is small, with a good font you can get 20 x 40 of text. For more details, check out <https://github.com/notro/fbttf/wiki/Boot-console> (<http://adafru.it/cXQ>)

First up, we'll update the boot configuration file to use the TFT framebuffer /dev/fb1 instead of the HDMI/TV framebuffer /dev/fb0

```
sudo nano /boot/cmdline.txt
```

you can also edit it by putting the SD card into a computer and opening the same file.

At the end of the line, find the text that says `rootwait` and right after that, enter in: `fbcon=map:10 fbcon=font:VGA8x8` then save the file.

On the next boot, it will bring up the console.

Note that the kernel has to load up the display driver module before it can display anything on it so you won't get the rainbow screen, a NooBs prompt, or a big chunk of the kernel details since the module is loaded fairly late in the boot process.

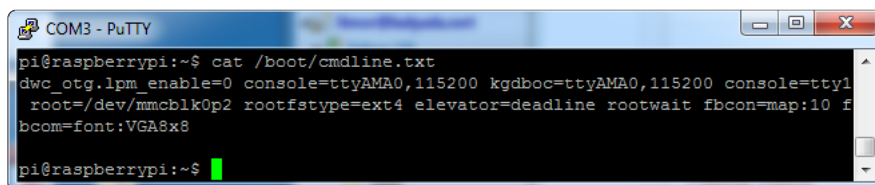

I think the VGA8x8 font is a bit chunky, you probably want 12x6 which is what is shown in the photo above. To change the font, run `sudo dpkg-reconfigure console-setup` and go thru to select Terminus 6x12

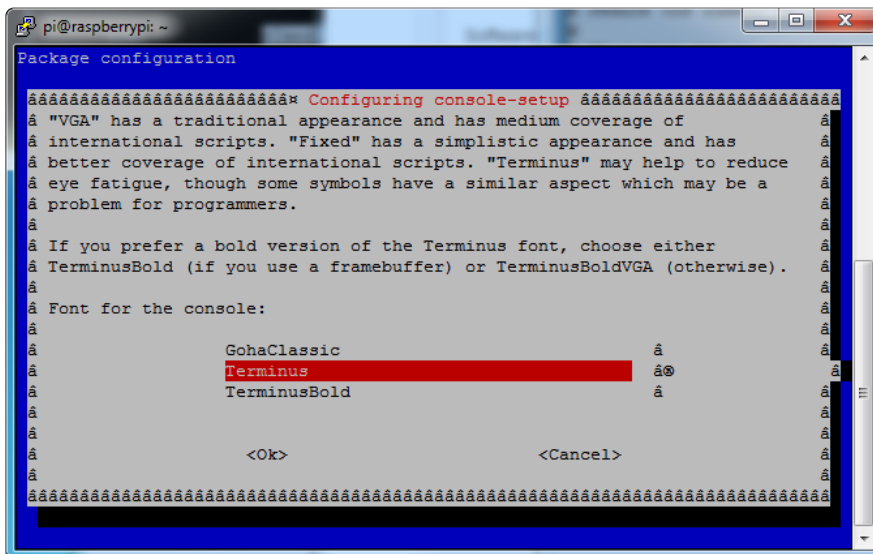
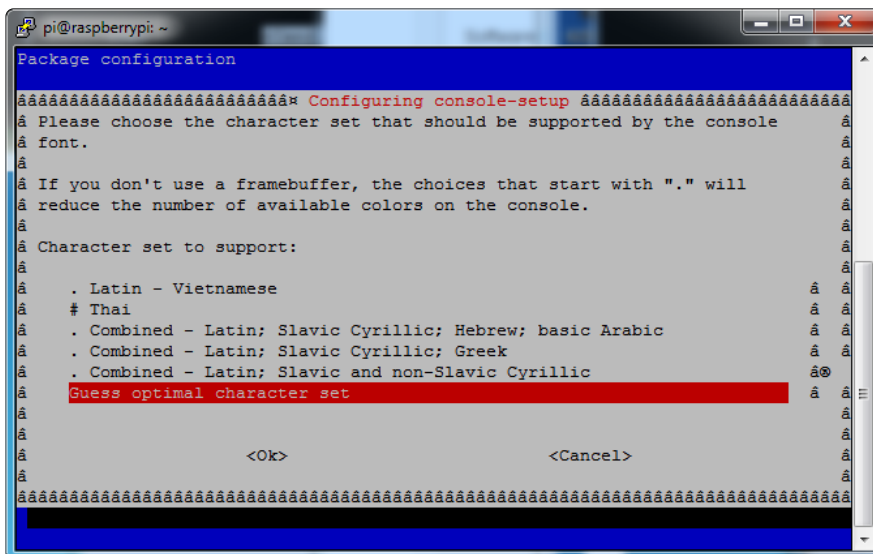
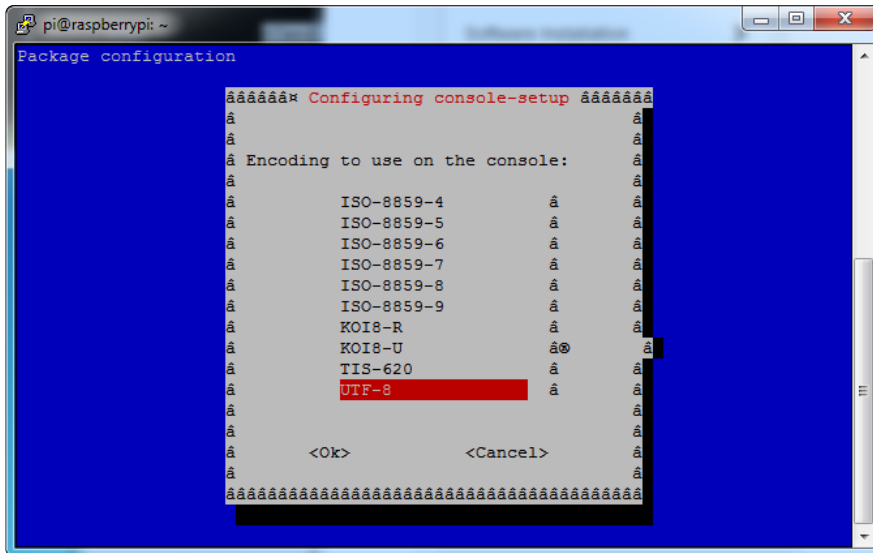

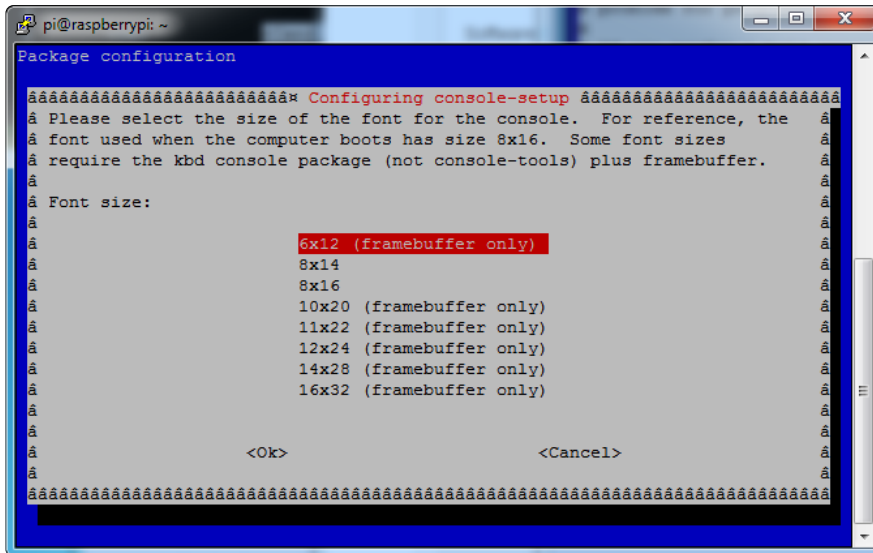

## Turn off Console Blanking

You may notice the console goes black after 30 minutes, this is a sort of 'power saving' or 'screensaver' feature.

## Raspbian Jessie

Add the following line to /etc/rc.local

```
sudo sh -c "TERM=linux setterm -blank 0 >/dev/tty0"
```

on the line before the final `exit 0`

## Raspbian Wheezy

You can disable this by editing /etc/kbd/config and looking for

```
BLANK_TIME=30
```

and setting the blank time to 0 (which turns it off)

```
BLANK_TIME=0
```



## Playing Videos



## How To Play Videos

You can play many types of videos on the screen, using mplayer you don't even need to run X and you can script the movies to play using Python. We'll show you how to just play one video for now.

To demo, we'll use an mp4 of Big Buck Bunny for 320 pixel wide screens. Below we

show you how to create/resize videos, but to make it easy, just download our version with:

```
wget http://adafruit-download.s3.amazonaws.com/  
bigbuckbunny320p.mp4 (https://adafru.it/cXR)
```

The video is 30MB which is a lot if you haven't expanded your SD card yet. Before you do this, run `sudo raspi-config` to expand the SD card so you don't run out of space!

If you don't have `mplayer` yet, run

```
sudo apt-get update
```

```
sudo apt-get install mplayer
```

to install it. It may take a few minutes to complete

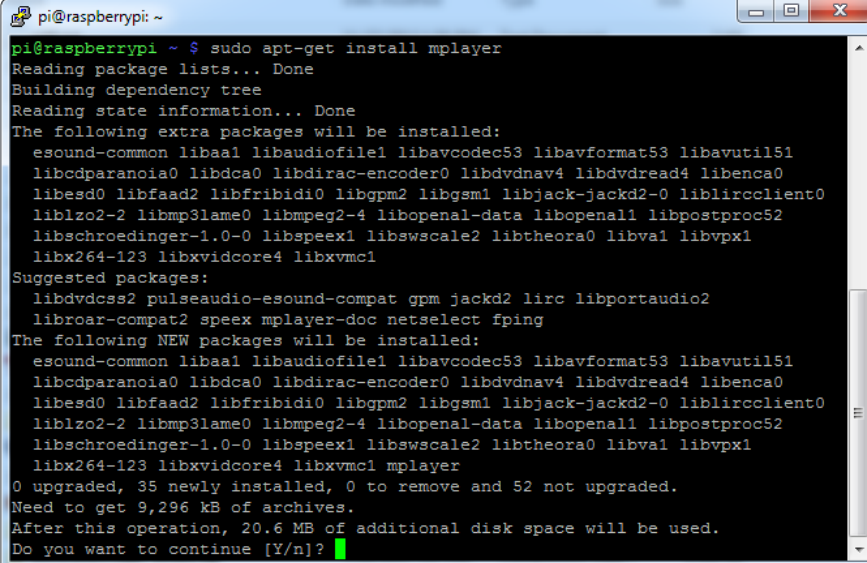

```
pi@raspberrypi: ~  
pi@raspberrypi ~ $ sudo apt-get install mplayer  
Reading package lists... Done  
Building dependency tree  
Reading state information... Done  
The following extra packages will be installed:  
  esound-common libaa1 libaudiofile1 libavcodec53 libavformat53 libavutil51  
  libcdparanoia0 libdca0 libdirac-encoder0 libdvdnav4 libdvdread4 libenca0  
  libesd0 libfaad2 libfribidi0 libgpm2 libgsm1 libjack-jackd2-0 liblircclient0  
  liblzo2-2 libmp3lame0 libmpeg2-4 libopenal-data libopenal1 libpostproc52  
  libschroedinger-1.0-0 libspeex1 libswscale2 libtheora0 libval1 libvpx1  
  libx264-123 libxvidcore4 libxvnc1  
Suggested packages:  
  libdvdcss2 pulseaudio-esound-compat gpm jackd2 lirc libportaudio2  
  libroar-compat2 speex mplayer-doc netselect fping  
The following NEW packages will be installed:  
  esound-common libaa1 libaudiofile1 libavcodec53 libavformat53 libavutil51  
  libcdparanoia0 libdca0 libdirac-encoder0 libdvdnav4 libdvdread4 libenca0  
  libesd0 libfaad2 libfribidi0 libgpm2 libgsm1 libjack-jackd2-0 liblircclient0  
  liblzo2-2 libmp3lame0 libmpeg2-4 libopenal-data libopenal1 libpostproc52  
  libschroedinger-1.0-0 libspeex1 libswscale2 libtheora0 libval1 libvpx1  
  libx264-123 libxvidcore4 libxvnc1 mplayer  
0 upgraded, 35 newly installed, 0 to remove and 52 not upgraded.  
Need to get 9,296 kB of archives.  
After this operation, 20.6 MB of additional disk space will be used.  
Do you want to continue [Y/n]? █
```

OK now you just have to run:

```
sudo SDL_VIDEODRIVER=fbcon SDL_FBDEV=/dev/fb1 mplayer -vo sdl -  
framedrop bigbuckbunny320p.mp4
```

If your video is not sized for 320 wide, you may need to add a `-zoom` after `-framedrop` so that it will resize - note that this is quite taxing for the Pi, so it may result in a choppy or mis-synced video!

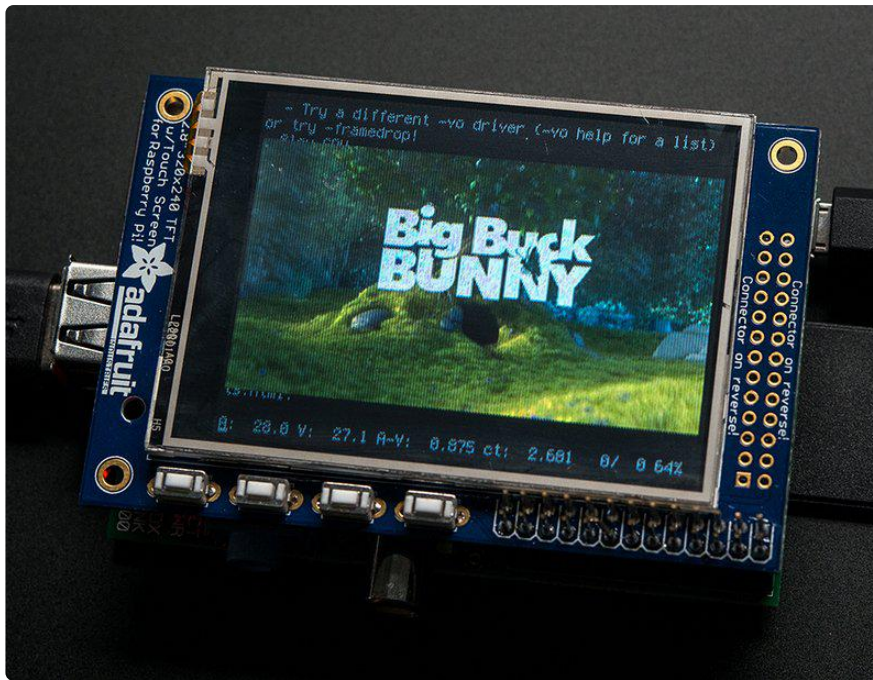

## Converting/Resizing Videos

It's possible to play full length videos on the TFT plate, but since the screen is small and the Pi can't use hardware acceleration to play the videos it's best to scale them down to 320x240 pixels. This will be easier for the Pi to play and also save you tons of storage space. For this demo, we'll be using the famous [Big Buck Bunny](https://adafruit.it/cXS) (<https://adafruit.it/cXS>) video, which is creative commons and also very funny!

You can download it from the link above, we'll be using the 720p AVI version.

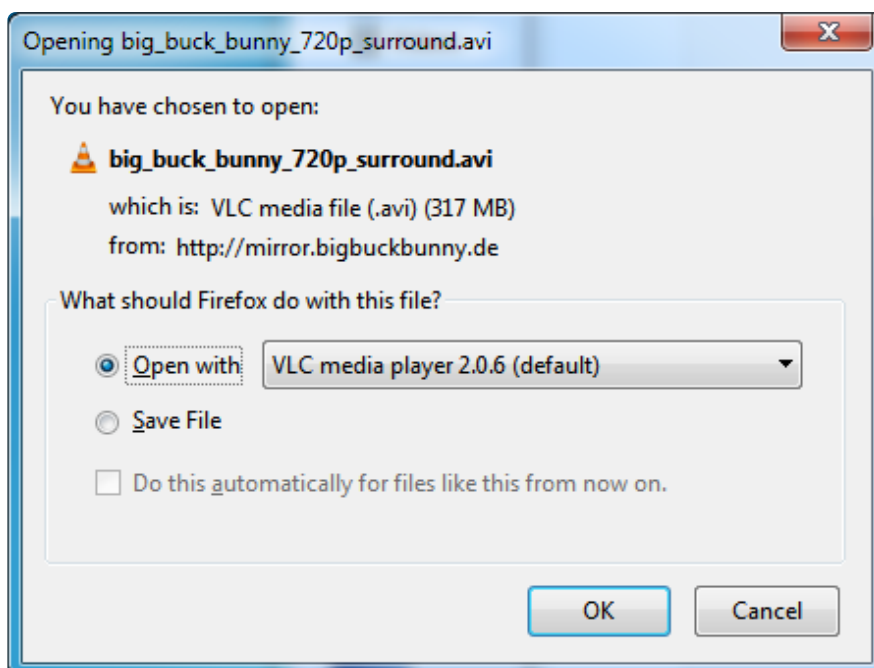

To do the conversion itself, we suggest [HandBrake](https://adafru.it/cXT) (<https://adafru.it/cXT>) which works great and is open source so it runs on all operating systems! Download and install from the link. Then run the installed application and open up the AVI file from before. The app will pre-fill a bunch of information about it.

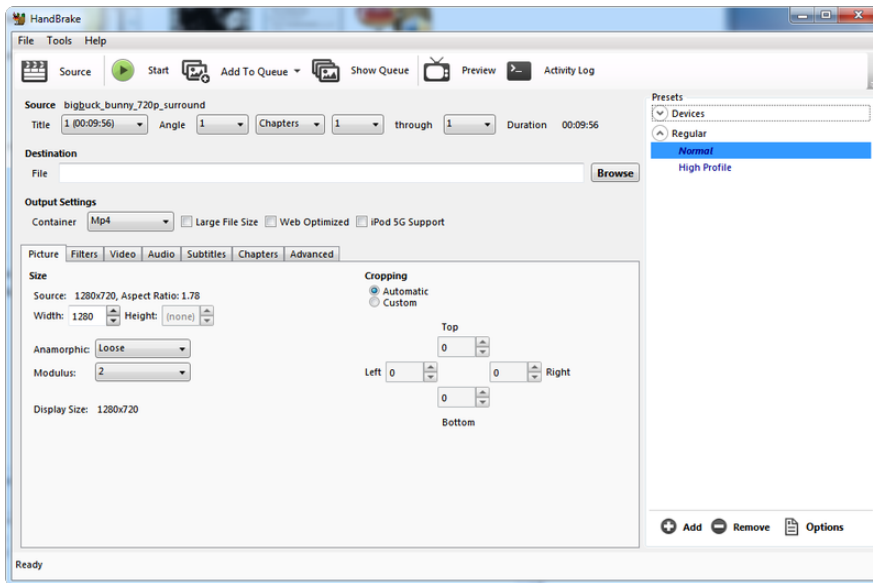

Under Destination click Browse... to select a new MP4 file to save. Then under Picture change the Width to 320 (the height will be auto-calculated)

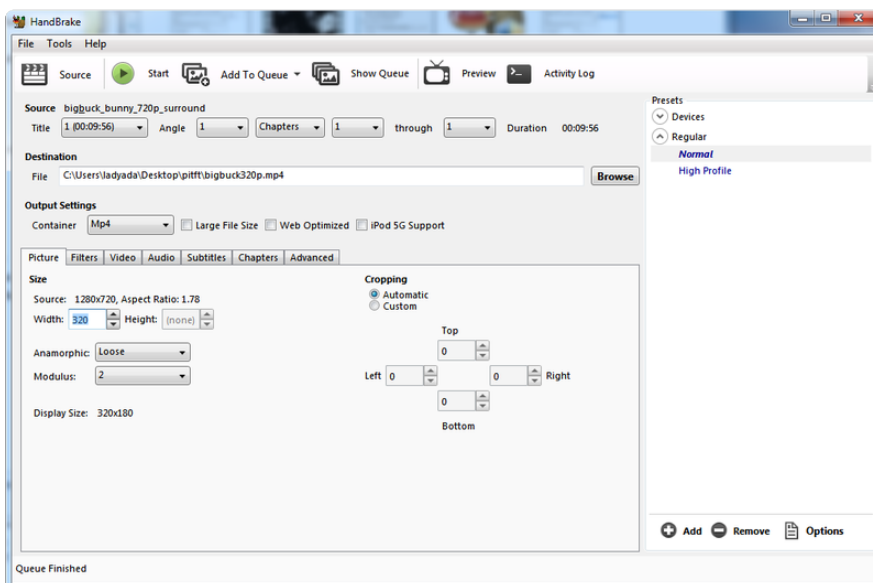

Click START to begin the conversion, it will take a minute or two.

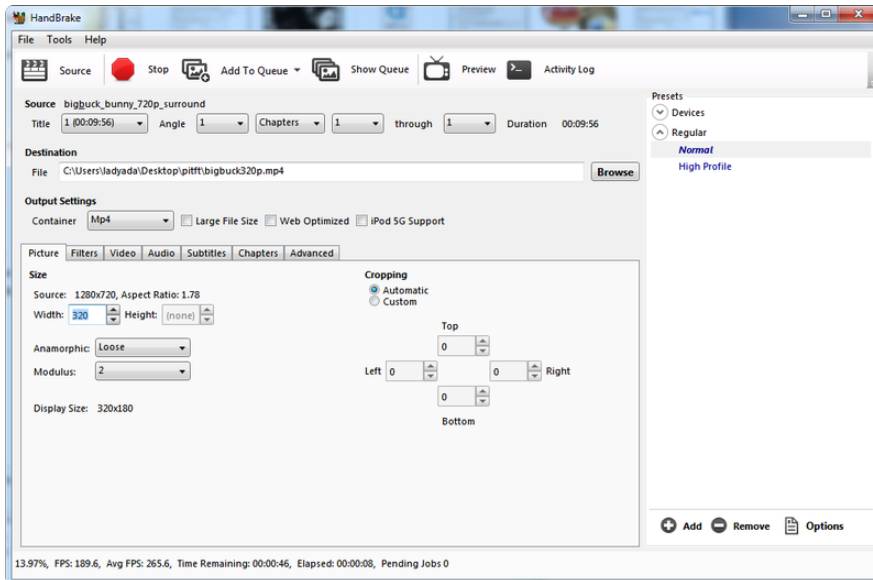

That's it! You now have a smaller file. Don't forget to play it on your computer to make sure it plays right before copying it to your Pi

---

## Displaying Images

You can display every day images such as GIFs, JPGs, BMPs, etc on the screen. To do this we'll install fbi which is the frame buffer image viewer (not to be confused with the FBI agency!)

sudo apt-get install fbi will install it

```
pi@raspberrypi:~$ sudo apt-get install fbi
Reading package lists... Done
Building dependency tree
Reading state information... Done
Suggested packages:
  imagemagick
The following NEW packages will be installed:
  fbi
0 upgraded, 1 newly installed, 0 to remove and 52 not upgraded.
Need to get 59.7 kB of archives.
After this operation, 157 kB of additional disk space will be used.
Get:1 http://mirrordirector.raspbian.org/raspbian/ wheezy/main fbi armhf 2.07-10 [59.7 kB]
Fetched 59.7 kB in 1s (40.0 kB/s)
Selecting previously unselected package fbi.
(Reading database ... 64758 files and directories currently installed.)
Unpacking fbi (from ../archives/fbi_2.07-10_armhf.deb) ...
Processing triggers for mime-support ...
Processing triggers for man-db ...
Setting up fbi (2.07-10) ...
pi@raspberrypi:~$
```



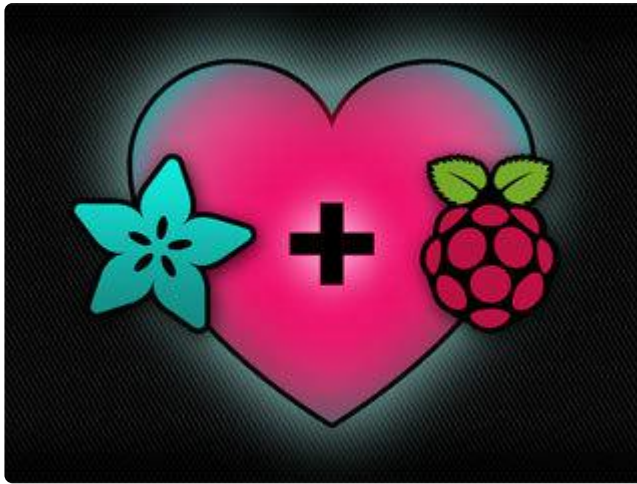

Grab our lovely wallpapers with

```
wget http://adafruit-download.s3.amazonaws.com/  
adapiluv320x240.jpg  
wget http://adafruit-download.s3.amazonaws.com/  
adapiluv480x320.png (https://adafru.it/cXU)
```

For 320x240 PiTFTs (2.2", 2.4", 2.8" or 3.2") view it with

```
sudo fbi -T 2 -d /dev/fb1 -noverbose -a adapiluv320x240.jpg
```

or for 3.5" PiTFTs:

```
sudo fbi -T 2 -d /dev/fb1 -noverbose -a adapiluv480x320 (ht  
tps://adafru.it/cXU).png
```

That's it!

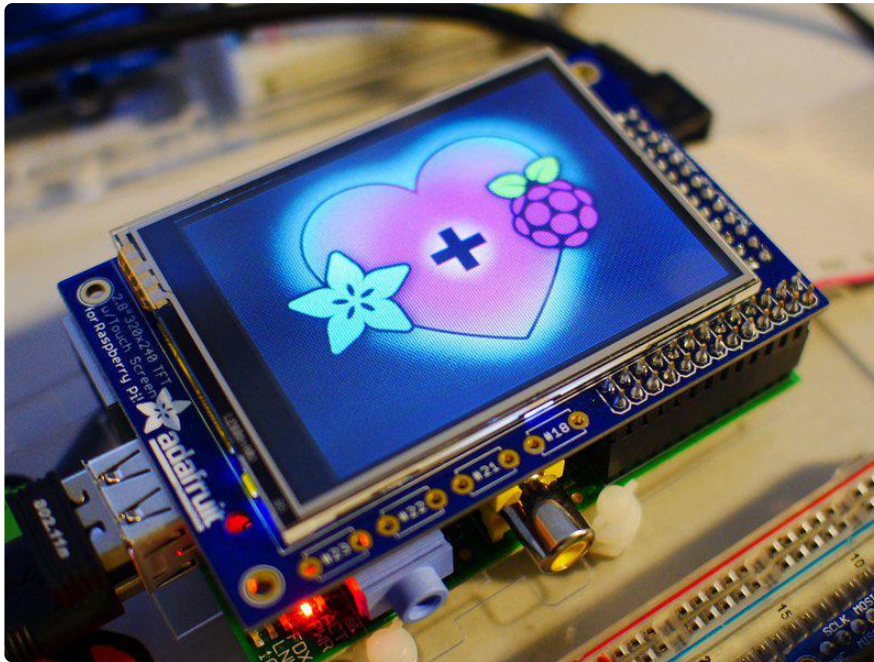

---

## Using FBCP



The Ideal: Adafruit's PiTFT displays are razor sharp. Whereas small composite screens on the Raspberry Pi usually require some video scaling (resulting in blurriness), PiTFT uses the GPIO header, digitally controlled pixel-by-pixel for a rock steady image. Though not a lot of pixels, it works great for retro gaming (and the display neatly stacks above the board, no side protuberances for video cables).

The Downside: this GPIO link entirely bypasses the Pi's video hardware, including the graphics accelerator. Many games and emulators depend on the GPU for performance gains. So the PiTFT has traditionally been limited to just a subset of specially-compiled emulators that can work and run well enough without the GPU.

The Solution: our latest PiTFT drivers, along with a tool called fbcf (framebuffer copy), careful system configuration, and (optionally) the more potent Raspberry Pi 2 board open the doors to many more gaming options. Existing emulator packages (such as RetroPie, with dozens of high-performance emulators and ports) — previously off-limits to the PiTFT — can run quite effectively now!

Click here to go to our FBCP tutorial!

<https://adafru.it/fbe>

## Backlight Control

Unlike the resistive PiTFT, the capacitive version does not have a resistive touch controller chip that we can take advantage of as an extra backlight control pin. Instead, you can set up GPIO #18 as an on/off or PWM control.

Note that if you are playing audio out the headphone jack, you can't use the PWM capabilities of GPIO #18 at the same time, the PWM function is reassigned to do audio. However, you can use it as a simple on/off pin

To enable using GPIO #18 as a backlight, solder closed the #18 backlight jumper on the PiTFT capacitive PCB!

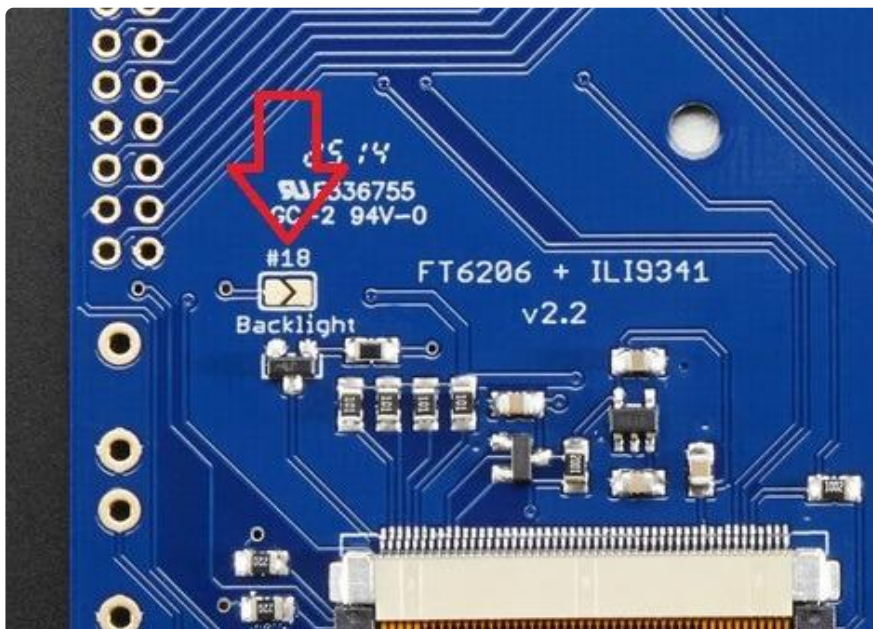

OK now you can use the PWM output on GPIO 18. There's python code available for controlling the PWM pin but you can also just use the WiringPi shell commands.

With these basic shell commands, you can set the GPIO #18 pin to PWM mode, set the output to 100 (out of 1023, so dim!), set the output to 1000 (out of 1023, nearly all the way on) and 0 (off)

```
gpio -g mode 18 pwm
gpio -g pwm 18 100
gpio -g pwm 18 1000
gpio -g pwm 18 0
```

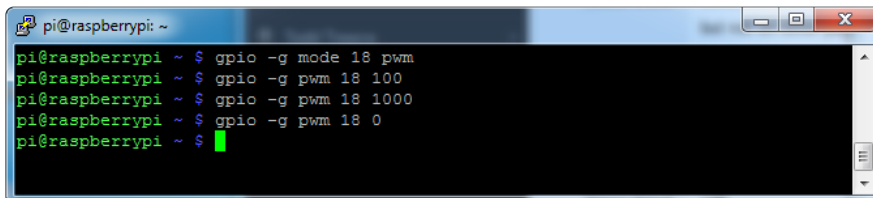
A terminal window titled 'pi@raspberrypi: ~' showing the execution of the four GPIO commands listed in the previous block. The prompt '\$' is used for each command, and the output is a green cursor on a new line after the final command.

```
pi@raspberrypi ~ $ gpio -g mode 18 pwm
pi@raspberrypi ~ $ gpio -g pwm 18 100
pi@raspberrypi ~ $ gpio -g pwm 18 1000
pi@raspberrypi ~ $ gpio -g pwm 18 0
pi@raspberrypi ~ $
```

Try other numbers, from 0 (off) to 1023 (all the way on)!

## Extras!

### Making it easier to click icons in X

If you want to double-click on icons to launch something in X you may find it annoying to get it to work right. In LXDE you can simply set it up so that you only need to single click instead of double.

From LXDE launch the file manager (sorry these pix are grayscale, still figuring out how to screenshot the framebuffer!)

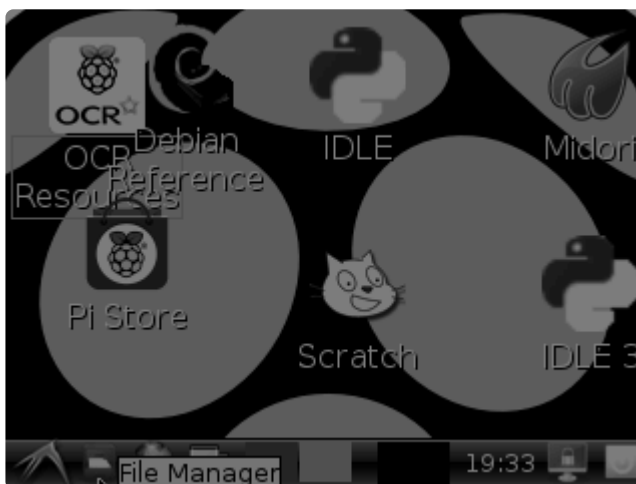

Then under the Edit menu, select Preferences

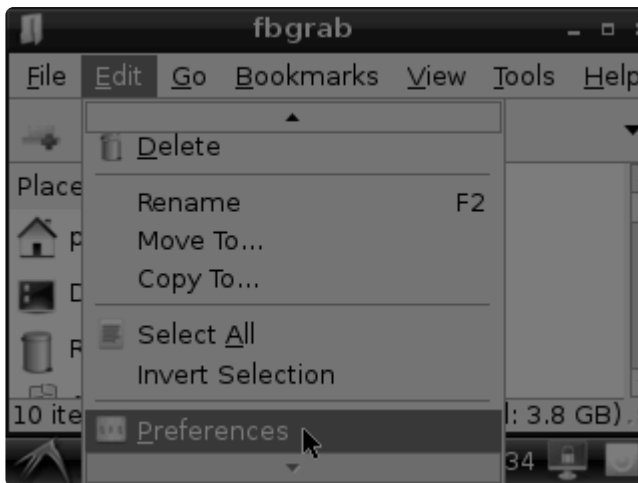

Then select Open files with single click and close the window (you'll need to drag it over to get to the X button

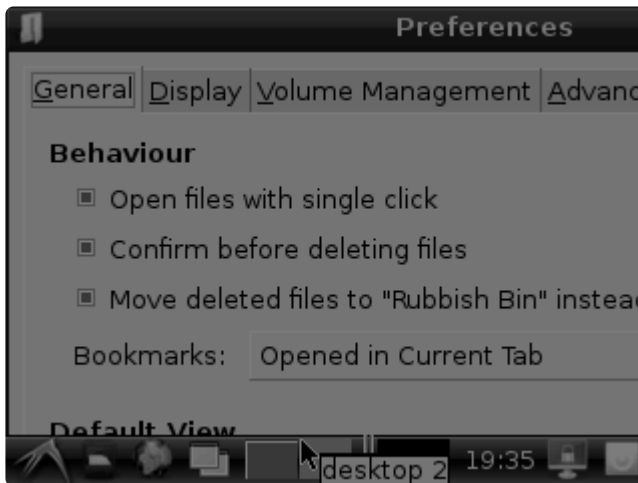

## Right-click on a touchscreen

Obviously if you have a touchscreen, it cannot tell what finger you are pressing with. This means that all 'clicks' are left clicks. But if you want a right-click, you can do it.

Just add the following lines into your InputClass of /etc/X11/xorg.conf.d/99-calibration.conf after the calibration section

```
Option "EmulateThirdButton" "1"  
Option "EmulateThirdButtonTimeout" "750"  
Option "EmulateThirdButtonMoveThreshold" "30"
```

So for example your file will look like:

```
Section "InputClass"
  Identifier      "calibration"
  MatchProduct   "stmpe-ts"
  Option "Calibration" "3800 120 200 3900"
  Option "SwapAxes" "1"
  Option "EmulateThirdButton" "1"
  Option "EmulateThirdButtonTimeout" "750"
  Option "EmulateThirdButtonMoveThreshold" "30"
EndSection
```

This makes a right mouse click emulated when holding down the stylus for 750 ms.

([Thx adamaddin! \(https://adafru.it/fH3\)](https://adafru.it/fH3))

---

## Gesture Input

With the PiTFT touchscreen and [xstroke \(https://adafru.it/dD0\)](https://adafru.it/dD0) you can enter text in applications by drawing simple character gestures on the screen! Check out the video below for a short demonstration and overview of gesture input with xstroke:

## Installation

Unfortunately xstroke hasn't been actively maintained for a few years so there isn't a binary package you can directly install. However compiling the tool is straightforward and easy with the steps below. Credit for these installation steps goes to [mwilliams03 at ozzmaker.com \(https://adafru.it/dD1\)](https://adafru.it/dD1).

First install a few dependencies by opening a command window on the Pi and executing:

```
sudo apt-get -y install build-essential libxft-dev libxpm-dev libxtst-dev
```

Now download, compile, and install xstroke by executing:

```
cd ~
wget http://mirror.egtvtdt.no/avr32linux.org/twiki/pub/Main/XStroke/
xstroke-0.6.tar.gz
tar xfv xstroke-0.6.tar.gz
cd xstroke-0.6
./configure
sed -i '/^X_LIBS = / s/$/ -lXrender -lX11 -lXext -ldl/' Makefile
make
sudo make install
```

If the commands above execute successfully xstroke should be installed. If you see an error message, carefully check the dependencies above were installed and try again.

Once xstroke is installed you will want to add a couple menu shortcuts to start and stop xstroke. Execute the following commands to install these shortcuts:

```
wget https://github.com/adafruit/PiTFT_Extras/raw/master/xstroke.desktop
wget https://github.com/adafruit/PiTFT_Extras/raw/master/xstrokekill.desktop
sudo cp xstroke*.desktop /usr/share/applications/
```

## Usage

To use xstroke I highly recommend using a plastic stylus instead of your finger. Also [calibrate the touchscreen for X-Windows \(https://adafru.it/dD2\)](https://adafru.it/dD2) so you have the best control over the cursor possible.

**Don't use a ballpoint pen or sharp metal stylus as it could scratch or damage the touchscreen!**

Start X-Windows on the PiTFT and open the LXDE menu by clicking the icon in the lower left corner. Scroll up to the Accessories menu at the top and notice the new XStroke and XStroke Kill commands.

Click the XStroke menu option to start xstroke. You should see a small pencil icon appear on the bottom right side of the screen. The pencil icon means xstroke is running, however by default it's not yet looking for gesture input.

Open an application that takes text input, such as LXTerminal. To enable gesture input click the xstroke pencil icon. You should see the pencil turn green and the text 'abc' written over top of the icon. You might need to click the icon a few times to get the click to register in the right spot.

When xstroke is looking for gesture input you can drag the mouse cursor in a gesture anywhere on the screen to send specific key strokes. Here's a picture of the possible gestures you can send:

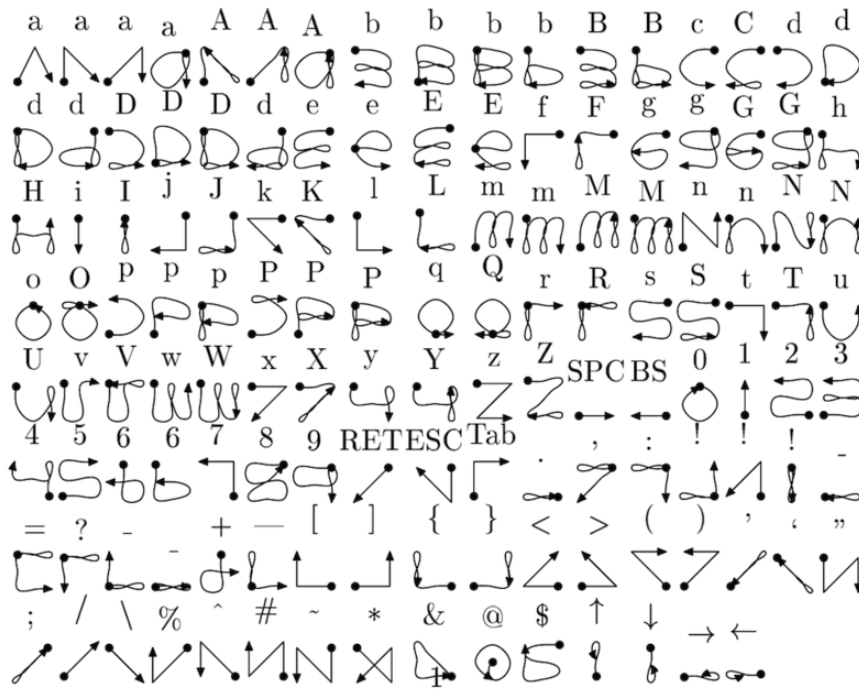

(credit to Carl Worth for the image above)

To draw a gesture from the above image, press anywhere on the screen, start from the circle in the gesture, and follow the gesture pattern towards the arrow. As you draw a gesture you should see a blue line displayed that shows what you've drawn. Lift up the stylus when you get to the end of the gesture at the arrow. If xstroke recognizes the gesture it will send the appropriate key press to the active window. Try drawing a few characters from the image above to get the hang of writing gestures.

A few very useful gestures are backspace (which deletes a character), return/enter, and space. To draw a backspace gesture just draw a line going from the right side of the screen to the left side. The gesture for return/enter is a diagonal line from the top right to bottom left. Finally a space is a straight line from the left to the right.

Note that when xstroke is looking for gestures you might not be able to click or control the cursor as you normally would expect. To stop xstroke's gesture recognition carefully press the xstroke pencil icon again until the 'abc' text disappears. I've found this process can be a little finicky as the icon is very small and any movement will be interpreted as a gesture. Use a light touch and try a few times to click the icon.

If you get stuck completely and can't disable xstroke by clicking the icon, connect to the Raspberry Pi in a terminal/SSH connection and run 'killall xstroke' (without quotes) to force xstroke to quit. The normal way to stop xstroke is to navigate to the Accessories -> XStroke Kill command, but you might not be able to do that if xstroke is listening for gesture input.



Have fun using xstroke to control your Pi by writing gestures on the PiTFT screen!

---

## PiTFT PyGame Tips

Since the PiTFT screen is fairly small, you may need to write custom UI programs. Pygame is the easiest way by far to do this.

[Jeremy Blythe has an excellent tutorial here on getting started. \(https://adafru.it/saw\)](https://adafru.it/saw)

However, before you follow that link you'll want to set up pygame for the best compatibility:

## Install pip & pygame

Install Pip: `sudo apt-get install python-pip`

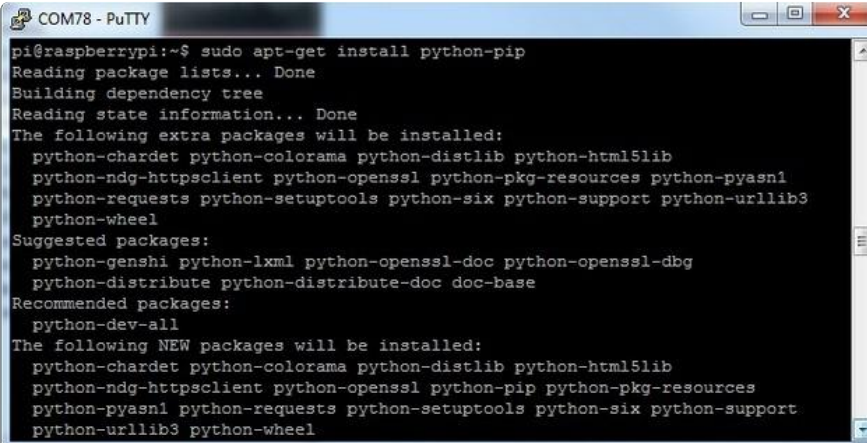

```
COM78 - PuTTY
pi@raspberrypi:~$ sudo apt-get install python-pip
Reading package lists... Done
Building dependency tree
Reading state information... Done
The following extra packages will be installed:
python-chardet python-colorama python-distlib python-html5lib
python-ndg-httpsclient python-openssl python-pkg-resources python-pyasnl
python-requests python-setuptools python-six python-support python-urllib3
python-wheel
Suggested packages:
python-genshi python-lxml python-openssl-doc python-openssl-dbg
python-distribute python-distribute-doc doc-base
Recommended packages:
python-dev-all
The following NEW packages will be installed:
python-chardet python-colorama python-distlib python-html5lib
python-ndg-httpsclient python-openssl python-pip python-pkg-resources
python-pyasnl python-requests python-setuptools python-six python-support
python-urllib3 python-wheel
```

Install Pygame: `sudo apt-get install python-pygame`

(this will take a while)

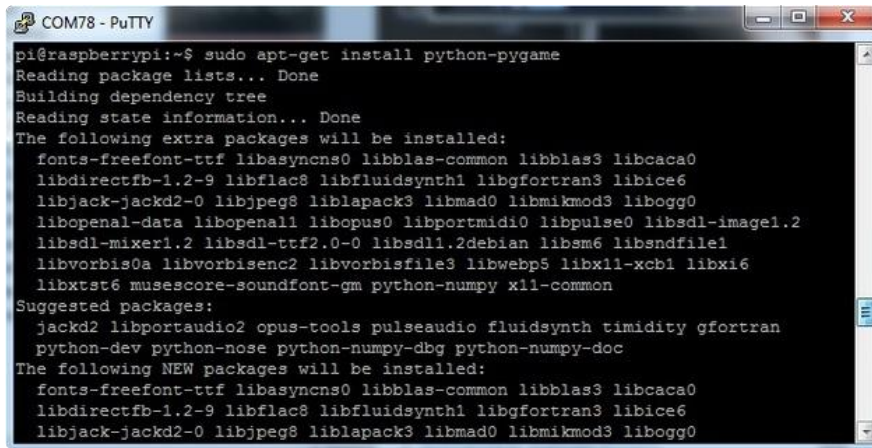

```
COM78 - PuTTY
pi@raspberrypi:~$ sudo apt-get install python-pygame
Reading package lists... Done
Building dependency tree
Reading state information... Done
The following extra packages will be installed:
 fonts-freefont-ttf libasyns0 libblas-common libblas3 libcac0
 libdirectfb-1.2-9 libflac8 libfluidsynth1 libgfortran3 libice6
 libjack-jackd2-0 libjpeg8 liblapack3 libmad0 libmikmod3 libogg0
 libopenal-data libopenal1 libopus0 libportmidi0 libpulse0 libSDL-image1.2
 libSDL-mixer1.2 libSDL-ttf2.0-0 libSDL1.2debian libsm6 libsndfile1
 libvorbis0a libvorbisenc2 libvorbisfile3 libwebp5 libx11-xcb1 libxi6
 libxtst6 musescore-soundfont-gm python-numpy x11-common
Suggested packages:
 jackd2 libportaudio2 opus-tools pulseaudio fluidsynth timidity gfortran
 python-dev python-nose python-numpy-dbg python-numpy-doc
The following NEW packages will be installed:
 fonts-freefont-ttf libasyns0 libblas-common libblas3 libcac0
 libdirectfb-1.2-9 libflac8 libfluidsynth1 libgfortran3 libice6
 libjack-jackd2-0 libjpeg8 liblapack3 libmad0 libmikmod3 libogg0
```

## Ensure you are running SDL 1.2

SDL 2.x and SDL 1.2.15-10 have some serious incompatibilities with touchscreen. You can force SDL 1.2 by running a script. ([Thanks to heine in the forums! \(https://adafru.it/sax\)](https://adafru.it/sax))

Edit a new file with `sudo nano installsdl.sh`  
and paste in the following text:

```
#!/bin/bash

# enable wheezy package sources
echo "deb http://legacy.raspbian.org/raspbian wheezy main" > /etc/apt/sources.list.d/wheezy.list

# set stable as default package source (currently buster)
echo "APT::Default-release \"stable\";" > /etc/apt/apt.conf.d/10defaultRelease

# set the priority for libSDL from wheezy higher than the buster package
echo "Package: libSDL1.2debian
Pin: release n=buster
Pin-Priority: -10
Package: libSDL1.2debian
Pin: release n=wheezy
Pin-Priority: 900" > /etc/apt/preferences.d/libSDL

# install
apt-get update
apt-get -y --allow-downgrades install libSDL1.2debian/wheezy
```

run

`sudo chmod +x installsdl.sh`

`sudo ./installsdl.sh`

```
COM78 - PuTTY
pi@raspberrypi:~$ sudo chmod +x installsdl.sh
pi@raspberrypi:~$ chmod +x installsdl.sh
chmod: changing permissions of 'installsdl.sh': Operation not permitted
^[[Api@raspberrypi
pi@raspberrypi:~$ sudo ./installsdl.sh
Hit http://apt.adafruit.com jessie InRelease
Hit http://mirrordirector.raspbian.org jessie InRelease
Hit http://archive.raspberrypi.org jessie InRelease
Get:1 http://archive.raspbian.org wheezy InRelease [14.9 kB]
Hit http://apt.adafruit.com jessie/main armhf Packages
Ign http://apt.adafruit.com jessie/main Translation-en_GB
Ign http://apt.adafruit.com jessie/main Translation-en
Hit http://mirrordirector.raspbian.org jessie/main armhf Packages
Hit http://mirrordirector.raspbian.org jessie/contrib armhf Packages
Hit http://archive.raspberrypi.org jessie/main armhf Packages
Hit http://mirrordirector.raspbian.org jessie/non-free armhf Packages
Hit http://archive.raspberrypi.org jessie/ui armhf Packages
Hit http://mirrordirector.raspbian.org jessie/rpi armhf Packages
Get:2 http://archive.raspbian.org wheezy/main armhf Packages [6,909 kB]
Ign http://archive.raspberrypi.org jessie/main Translation-en_GB
Ign http://archive.raspberrypi.org jessie/main Translation-en
Ign http://archive.raspberrypi.org jessie/ui Translation-en_GB
Ign http://archive.raspberrypi.org jessie/ui Translation-en
Ign http://mirrordirector.raspbian.org jessie/contrib Translation-en_GB
Ign http://mirrordirector.raspbian.org jessie/contrib Translation-en
Ign http://mirrordirector.raspbian.org jessie/main Translation-en_GB
Ign http://mirrordirector.raspbian.org jessie/main Translation-en
Ign http://mirrordirector.raspbian.org jessie/non-free Translation-en_GB
Ign http://mirrordirector.raspbian.org jessie/non-free Translation-en
Ign http://mirrordirector.raspbian.org jessie/rpi Translation-en_GB
Ign http://mirrordirector.raspbian.org jessie/rpi Translation-en
51% [Packages 0 B] [2 Packages 3,494 kB/6,909 kB 51%] 580 kB/s 5s
```

it will force install SDL 1.2

```
COM78 - PuTTY
Ign http://archive.raspbian.org wheezy/main Translation-en_GB
Ign http://archive.raspbian.org wheezy/main Translation-en
Fetched 6,924 kB in 42s (162 kB/s)
Reading package lists... Done
Reading package lists... Done
Building dependency tree
Reading state information... Done
Selected version '1.2.15-5' (Raspbian:7.0/oldstable [armhf]) for 'libsdl1.2debian'
The following packages will be DOWNGRADED:
  libsdl1.2debian
0 upgraded, 0 newly installed, 1 downgraded, 0 to remove and 21 not upgraded.
Need to get 203 kB of archives.
After this operation, 12.3 kB of additional disk space will be used.
Get:1 http://archive.raspbian.org/raspbian/ wheezy/main libsdl1.2debian armhf 1.2.15-5 [203 kB]
Fetched 203 kB in 1s (134 kB/s)
dpkg: warning: downgrading libsdl1.2debian:armhf from 1.2.15-10+rpil to 1.2.15-5
(Reading database ... 33729 files and directories currently installed.)
Preparing to unpack ../libsdl1.2debian_1.2.15-5_armhf.deb ...
Unpacking libsdl1.2debian:armhf (1.2.15-5) over (1.2.15-10+rpil) ...
Setting up libsdl1.2debian:armhf (1.2.15-5) ...
Processing triggers for libc-bin (2.19-18+deb8u1) ...
pi@raspberrypi:~$
```

OK now you can continue with pygame

# Using the Capacitive touch screen in PyGame

The 2.8" Capacitive touch screen driver may not work by default in pygame, but this handy script shows how you can capture the device messages in python to create a UI

- <https://github.com/nift4/pigame> (<https://adafru.it/CYv>)

For examples:

<https://github.com/nift4/Raspberry-Pi-Testing> (<https://adafru.it/CYA>)

---

## F.A.Q.

---

### The display works, but the capacitive touch part doesnt

Check that you installed the right image, there's one for resistive and one for capacitive PiTFT's

If that doesn't help, you can verify your RasPi model number with the command `cat /proc/cpuinfo`, if it's revision # 0002 or 0003 [that means it's a rev 1 Model B](https://adafru.it/dXg), (<https://adafru.it/dXg>) and will not work due to the I2C pins changing.

---

### Does this screen do multi-touch?

Nope! This capacitive touch screen is single-touch only.

---

### Hey...I was looking at the FT6206 datasheet and it looks like it can support multitouch (two points)!

The chip does in fact support multitouch, but the screen layout itself is single-touch.

We'll keep looking for a low cost multitouch screen, but we found that at the small size of this screen, single-touch is pretty good! Also, very few linux programs support MT.

---

### How do I automatically boot to X windows on the PiTFT?

Check out the [2.8" resistive PiTFT FAQ](https://adafru.it/dJ2) (<https://adafru.it/dJ2>) for an answer to this common question.

---

# I have some more questions!

Check out the 2.8" Resistive PiTFT FAQ page for some other questions you may want answered

---

Visit the 2.8" Resistive PiTFT FAQ page

<https://adafru.it/dJ2>

---

## Downloads

## Files

- [The latest kernel fork that adds all the TFT, touchscreen, and other addons is here on github \(https://adafru.it/aPa\)](https://adafru.it/aPa)
- [Datasheet for the 'raw' 2.8" TFT display \(https://adafru.it/sEt\)](https://adafru.it/sEt)
- [FT6206 Datasheet \(https://adafru.it/sEu\)](https://adafru.it/sEu) & [App note \(https://adafru.it/dRn\)](https://adafru.it/dRn) (capacitive chip)
- [EagleCAD PCB files on GitHub \(https://adafru.it/oYC\)](https://adafru.it/oYC)

## Schematic for Pi 1 Version

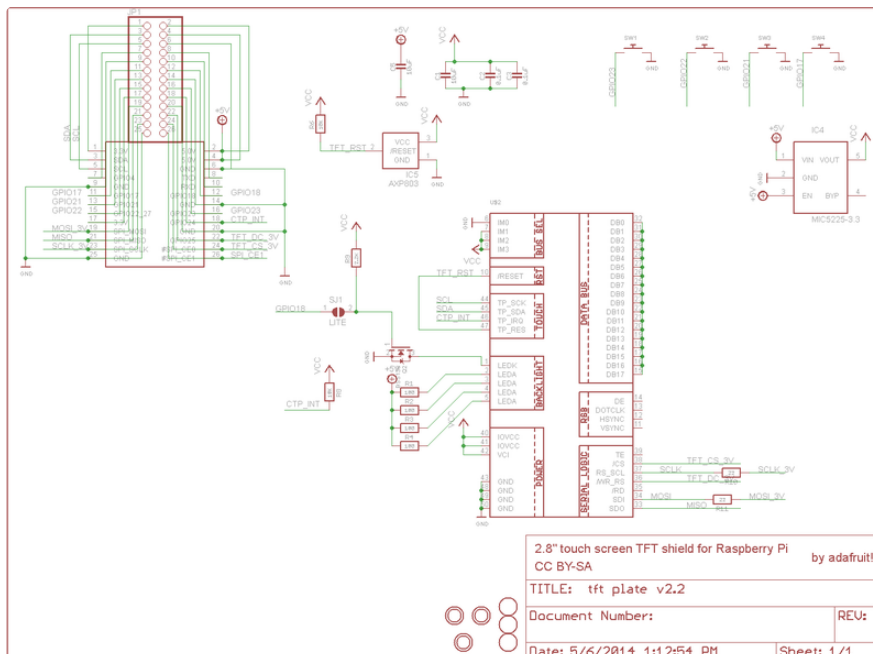

# Schematic for PiTFT Plus (B+/Pi 2 shape)

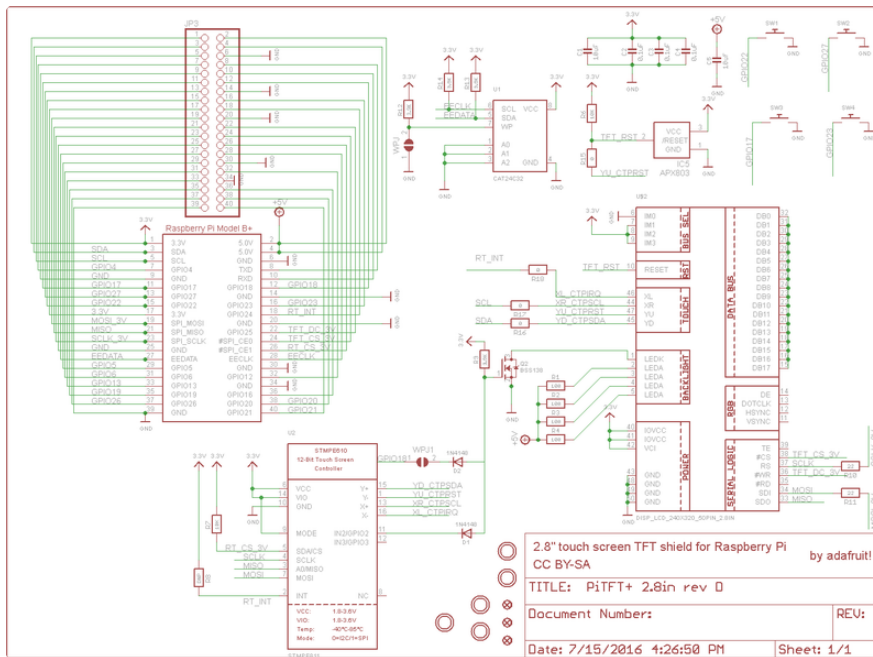

# Fabrication Print (Pi 1 Version)

Dimensions in Inches

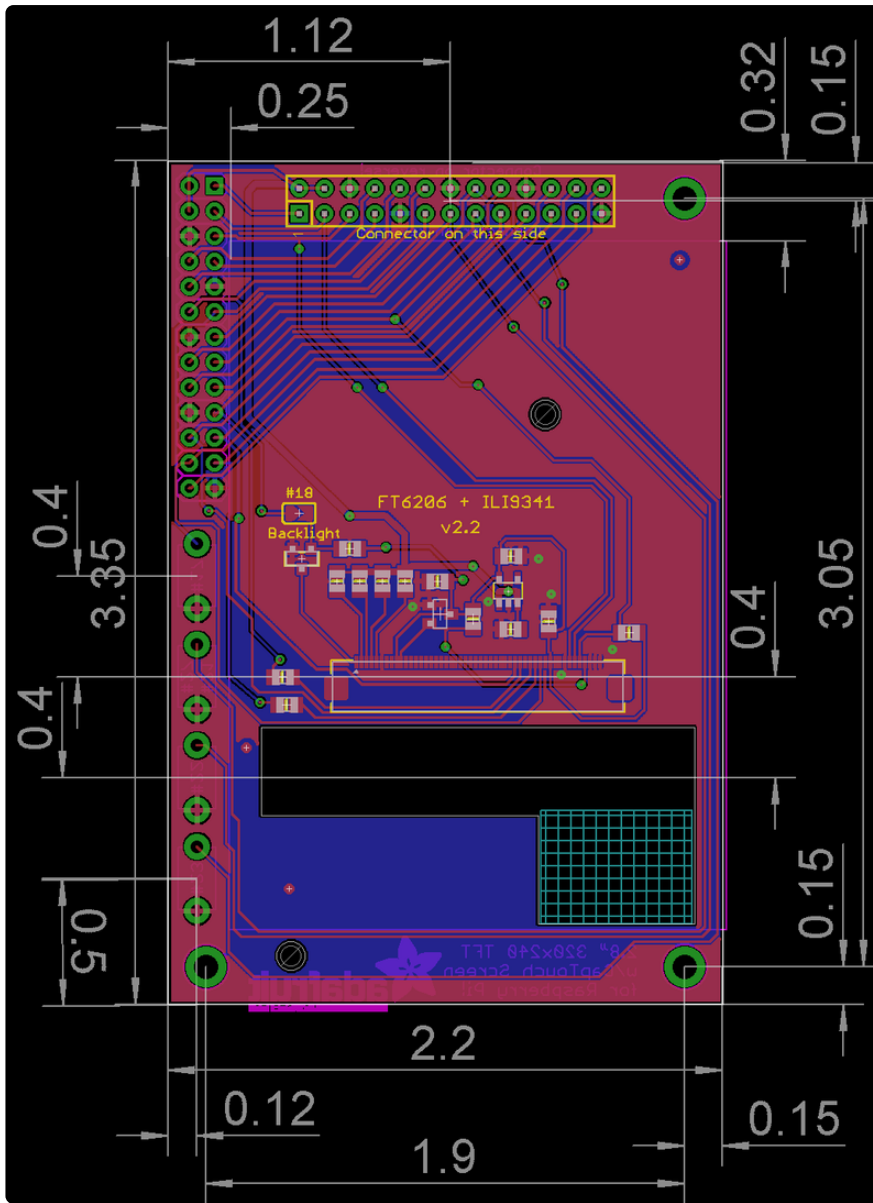

## Fabrication Print (B+/Pi 2 Version)

Dimensions in mm