

Commercial Thermostats



DESCRIPTION

Thermostats can provide either temperature control or over-temperature protection by breaking electrical contact when a specified temperature is reached.

Honeywell manufactures a wide range of 12,7 mm [0.5 in] commercial snap-action thermostats for possible use in a wide array of small and major appliances, office copy machines, medical equipment, heat detectors, HVAC equipment and more.

These snap-action thermostats include automatic and manual reset options, phenolic or ceramic housings and a wide variety of mounting brackets and terminal options.

Each thermostat's design is configured from a base unit, and may be customized for temperature tolerance and mechanical configurations, meeting the customer's needs for accuracy and exactitude.

Honeywell can also integrate these thermostats in higher value cable assemblies, incorporating wire harness and connectors.

TABLE OF CONTENTS

DESCRIPTION	p. 1
NOMENCLATURE	p. 2
DEFINITION OF TERMS	p. 3
NOTES	p. 3
COMMERCIAL THERMOSTATS	
2450R/2450HR/2455R/2452R/2452HR Series Phenolic Automatic Reset	p. 4
2450RC/2450RCH/2455RC Series Ceramic Automatic Reset	p. 6
2455RM/2450CM Series Phenolic or Ceramic Manual Reset	p. 9
2455RD Series Phenolic Manual Reset	p. 11
2455RBV Series Overmolded Automatic Reset	p. 13
2450A/2455RA Series Heat Detection	p. 15
2450R/2455R/2450RC/2455RC/2450HR/2450RCH Series "One Shot"	p. 17
REDI-TEMP THERMOSTATS	
3455RC Series	p. 19
MOUNTING HARDWARE	
Brackets	p. 20
Brass mounting studs	p. 21
Terminals	p. 22

Commercial Thermostats

NOMENCLATURE

The nomenclature given in Figure 1 is provided for reference only.

Figure 1. Commercial Thermostat Nomenclature



DEFINITION OF TERMS

- **Automatic Reset:** A type of thermostat that will automatically reset at a specific temperature (i.e. a thermostat operates at 65,5 °C [150 °F] and resets at 48,89 °C [120 °F]).
- **Bimetal:** Two dissimilar metals bonded together to form the material for manufacturing thermally-sensitive discs which actuate the thermostat.
- **Close on Rise (COR):** Refers to operation of the contacts. When the temperature rises to its set point, the contacts close or make contact and complete the circuit.
- **Contact Resistance:** The value of resistance measured between the terminals.
- **Dielectric Strength:** The value of insulation between two electrically conducting parts. It may be tested by the application of a predetermined overvoltage for a specified time.
- **Differential:** The temperature difference between the operate and reset set points, also known as operate and reset.
 - **Nominal:** The temperature difference between nominal set points regardless of tolerance.
 - **Maximum:** Maximum number of degrees between actual opening and closing set points.
 - **Minimum:** Minimum number of degrees between actual opening and closing set points.
- **Exposure Temperature:** Thermal environment of a device during application operation.
- **FLA (Full Load Amps):** Current taken from the line by the motor when the motor is yielding the rated hp at the rated voltage and frequency.
- **Life Cycles:** The endurance rating of the thermostat expressed in number of operations with stated electrical load applied. Temperature limit application = open on rise.
- **LRA (Locked Rotor Amps):** The amount of current the motor can be expected to draw under starting conditions when full voltage is applied, also known as starting inrush current.
- **Manual Reset:** A bimetal thermostat with a reset button that must be pressed to reset the contacts.
- **Open on Rise (OOR):** Refers to the operation of contacts. When the temperature rises to its set point the contacts open, terminating the circuit.
- **Overmold:** Encapsulation with an insulating material.
- **Phenolic:** Thermoset plastic used for the insulating body of the thermostat.
- **Set Point:** The nominal temperature at which the thermostat operates.
- **SPST (Single Pole/Single Throw):** A switch with one current path which can be either open or closed.
- **Tolerance:** The allowable range above and below the set point temperature.
- **Operate:** Change of state when the thermostat reaches its set point.
- **Reset:** Change of state when the thermostat returns to its original condition prior to operation.

NOTES

- **Standard Temperature Characteristics Tables:**
 - **Temperatures:** Please consult applications engineering for temperature ranges, tolerances and differentials not noted. The operating temperature ranges include tolerances.
 - **Tolerances:** The \pm tolerances given have been established after review of many thermostat applications. Attempts should be made to establish the widest acceptable tolerance possible.
- **UL and CSA Approvals:** 12,7 mm [0.5 in] thermostats are available with multiple agency approval for incorporation into equipment.
- **Fan control applications:** Require thermostat set points to be derated by 20 °C from the equivalent temperature limit application. They also close on rise.
- **Dimensions:** Are for reference only and are given in mm [in].

Commercial Thermostats

Figure 2. 2450R/2450HR/2455R/2452R/2452HR Series Phenolic Automatic Reset Thermostat



Table 1. 2450R/2450HR/2455R/2452R/2452HR Series Standard Temperature Characteristics

Operating Temperature Range	Tolerance		Standard Mean Differential °C [°F]
	Open °C [°F]	Close °C [°F]	
0 °C to 26 °C [32 °F to 79 °F]	±4 [±7]	±6 [±10]	28 to 34 [50 to 60]
	±4 [±6]	±6 [±10]	22 to 27 [40 to 49]
	±4 [±6]	±5 [±9]	17 to 22 [30 to 39]
	±4 [±6]	±5 [±8]	14 to 16 [25 to 29]
	±3 [±5]	±5 [±8]	8 to 14 [15 to 24]
27 °C to 82 °C [80 °F to 180 °F]	±5 [±9]	±8 [±15]	45 to 56 [81 to 100]
	±4 [±7]	±6 [±11]	34 to 45 [61 to 80]
	±4 [±6]	±6 [±10]	28 to 34 [50 to 60]
	±3 [±5]	±6 [±10]	22 to 27 [40 to 49]
	±3 [±5]	±5 [±9]	17 to 22 [30 to 39]
83 °C to 110 °C [181 °F to 230 °F]	±3 [±5]	±5 [±8]	8 to 16 [15 to 29]
	±6 [±10]	±8 [±15]	45 to 56 [81 to 100]
	±5 [±8]	±8 [±15]	34 to 45 [61 to 80]
	±4 [±7]	±7 [±12]	28 to 34 [50 to 60]
	±4 [±6]	±6 [±10]	22 to 27 [40 to 49]
	±4 [±6]	±5 [±9]	17 to 22 [30 to 39]
111 °C to 150 °C [231 °F to 302 °F]	±4 [±6]	±5 [±8]	8 to 16 [15 to 29]
	±7 [±12]	±10 [±18]	45 to 56 [80 to 100]
	±5 [±9]	±8 [±15]	34 to 45 [61 to 80]
	±5 [±8]	±7 [±12]	28 to 34 [50 to 60]
	±4 [±7]	±7 [±12]	22 to 27 [40 to 49]
	±4 [±7]	±6 [±11]	17 to 22 [30 to 39]
	±4 [±7]	±6 [±10]	14 to 16 [25 to 29]

Table 2. 2450R/2450HR/2455R/2452R/2452HR Series Specifications

Characteristic	Parameter
Switch type	SPST
Reset type	automatic
Amperage	See Tables 3, 4
Voltage	120 Vac to 250 Vac
Operating temperature range	0 °C to 150 °C [32 °F to 302 °F]
Environmental exposure range	-18 °C to 177 °C [0 °F to 350 °F]
Materials:	
Base	phenolic
Contacts	silver alloy
Terminals	unplated brass, plated brass or steel
Closure	aluminum, brass or stainless steel
Brackets	aluminum or stainless steel
UL and CSA approvals	<ul style="list-style-type: none"> • 2455R: 6,35 mm [0.25 in] clearance; UL File MH8267, UL File E36103; CSA File LR21048 • 2450HR: 1,59 mm [0.0625 in] clearance; UL File E36103; CSA File LR21048 • 2450R: 1,59 mm [0.0625 in] clearance; UL File E36103; CSA File LR 21048 • 2452R: 2.66mm [0.105 in] clearance; UL E36103 • 2452HR: 2.66mm [0.105 in] clearance; UL36103
Weight	6 g [0.2 oz] (does not include brackets or wire leads)

Table 3. 2450R/2450HR/2452R/2452HR Contact Ratings

Life Cycles	120 Vac	240 Vac	277 Vac
100,000	15 A resistive	10 A resistive	10 A resistive
30,000	125 VA pilot duty	125 VA pilot duty	-

Note: 2450 approval rating is limited by EN60730-1 to 125 Vac max.

Table 4. 2455R Contact Ratings

Life Cycles	120 Vac	240 Vac	277 Vac
100,000	15 A resistive 4.4 FLA 26.4 LRA 125 VA pilot duty	10 A resistive 2.2 FLA 13.2 LRA 125 VA pilot duty	7.2 A resistive
6,000	5.8 FLA, 34.8 LRA	2.9 FLA, 17.4 LRA	-

Note: Additional contact ratings are available, please contact Honeywell.

Figure 3. 2450R/2450HR/2455R/2452R/2452HR Basic Dimensions

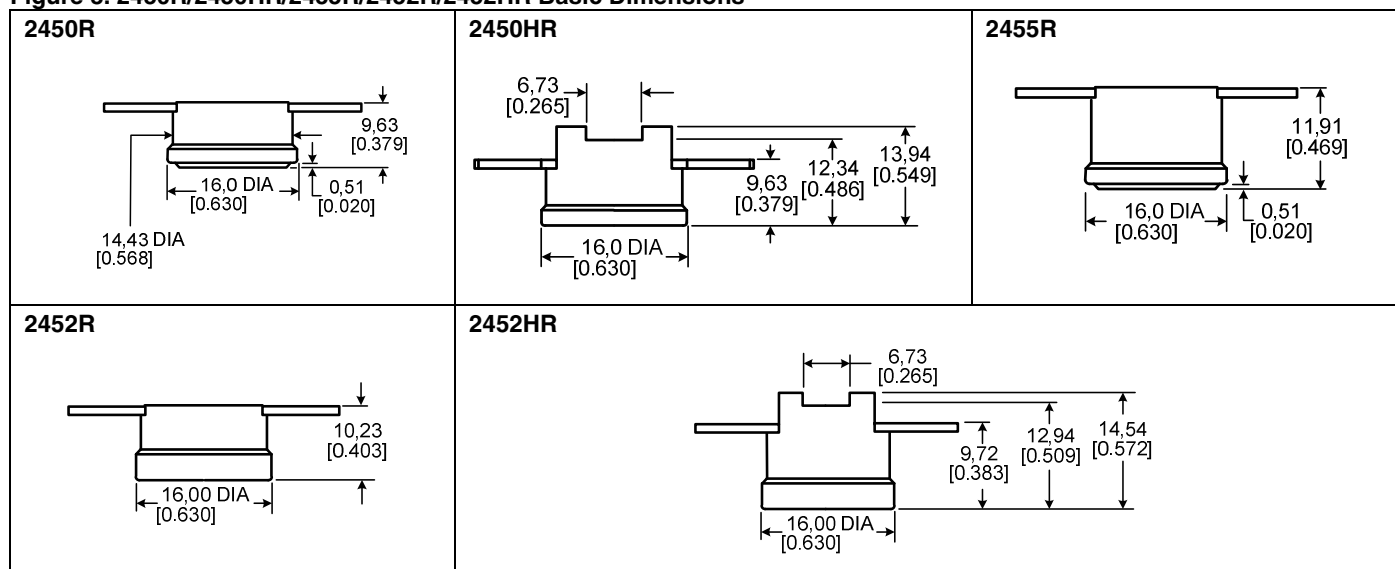

Commercial Thermostats

Figure 4. 2450RC/2450RCH/2455RC Series Automatic Reset Thermostat

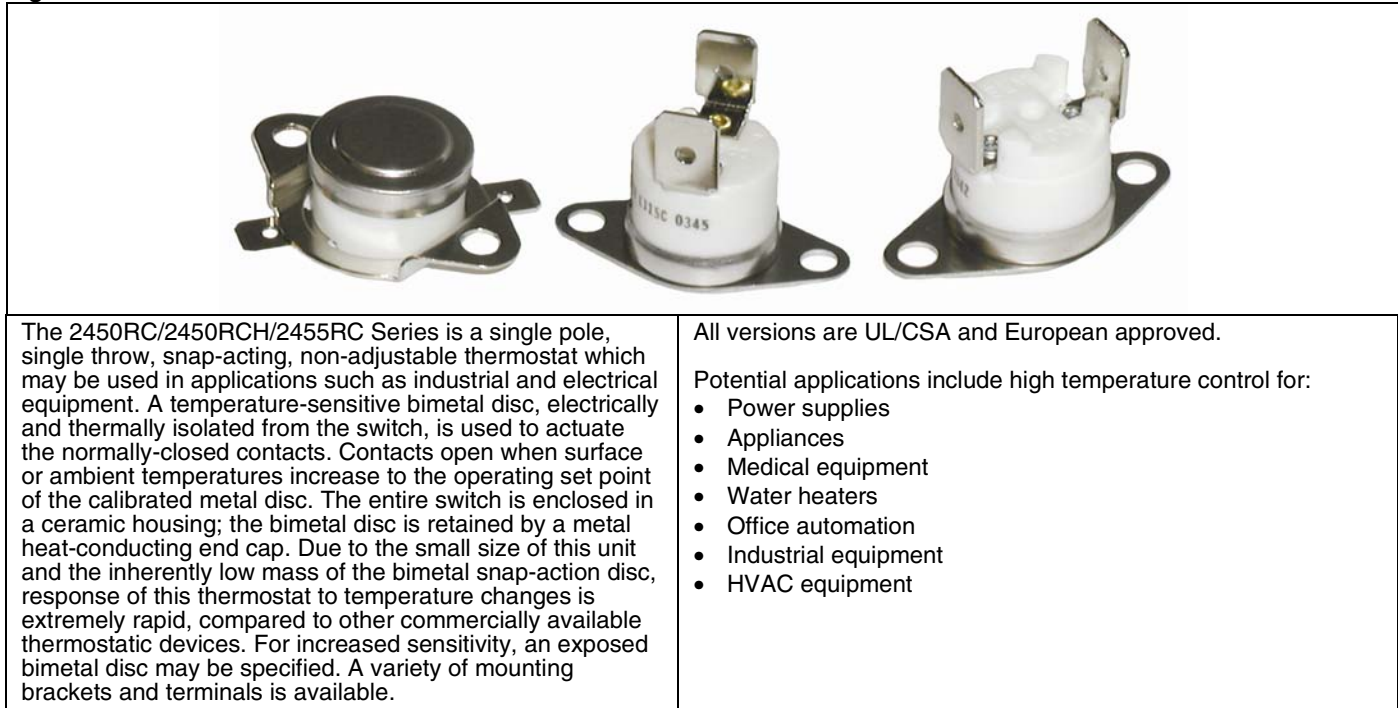

Table 5. 2450RC/2450RCH/2455RC Series Standard Temperature Characteristics

Operating Temperature Range	Tolerance		Standard Mean Differential °C [°F]
	Open °C [°F]	Close °C [°F]	
0 °C to 26 °C [32 °F to 79 °F]	±4 [±7]	±6 [±10]	28 to 34 [50 to 60]
	±4 [±6]	±6 [±10]	22 to 27 [40 to 49]
	±4 [±6]	±5 [±9]	17 to 22 [30 to 39]
	±4 [±6]	±5 [±8]	14 to 16 [25 to 29]
	±3 [±5]	±5 [±8]	8 to 14 [15 to 24]
27 °C to 82 °C [80 °F to 180 °F]	±5 [±9]	±8 [±15]	45 to 56 [81 to 100]
	±4 [±7]	±6 [±11]	34 to 45 [61 to 80]
	±4 [±6]	±6 [±10]	28 to 34 [50 to 60]
	±3 [±5]	±6 [±10]	22 to 27 [40 to 49]
	±3 [±5]	±5 [±9]	17 to 22 [30 to 39]
83 °C to 110 °C [181 °F to 230 °F]	±3 [±5]	±5 [±8]	8 to 16 [15 to 29]
	±6 [±10]	±8 [±15]	45 to 56 [81 to 100]
	±5 [±8]	±8 [±15]	35 to 45 [61 to 80]
	±4 [±7]	±7 [±12]	28 to 34 [50 to 60]
	±4 [±6]	±6 [±10]	22 to 27 [40 to 49]
	±4 [±6]	±5 [±9]	17 to 22 [30 to 39]
	±4 [±6]	±5 [±8]	8 to 16 [15 to 29]

Table 6. 2450RC/2450RCH/2455RC Series Standard Temperature Characteristics (continued)

Operating Temperature Range	Tolerance		Standard Mean Differential °C [°F]
	Open °C [°F]	Close °C [°F]	
111 °C to 149 °C [231 °F to 300 °F]	±7 [±12]	±10 [±18]	45 to 56 [81 to 100]
	±5 [±9]	±8 [±15]	34 to 45 [61 to 80]
	±5 [±8]	±7 [±12]	28 to 34 [50 to 60]
	±4 [±7]	±7 [±12]	22 to 27 [40 to 49]
	±4 [±7]	±6 [±11]	17 to 22 [30 to 39]
	±4 [±7]	±6 [±10]	14 to 16 [25 to 29]
150 °C to 170 °C [301 °F to 335 °F]	±8 [±15]	±11 [±20]	39 to 45 [71 to 80]
	±6 [±10]	±11 [±20]	34 to 39 [61 to 70]
	±6 [±10]	±8 [±15]	28 to 33 [50 to 60]
	±6 [±10]	±7 [±12]	22 to 27 [40 to 49]
171 °C to 220 °C [336 °F to 425 °F]	±14 [±25]	±14 [±25]	51 to 56 [91 to 100]
	±11 [±20]	±11 [±20]	39 to 50 [71 to 90]
	±8 [±15]	±11 [±20]	28 to 39 [50 to 70]
221 °C to 235 °C [426 °F to 450 °F]	±14 [±25]	±14 [±25]	51 to 56 [91 to 100]
	±11 [±20]	±11 [±20]	39 to 50 [71 to 90]
	±8 [±15]	±11 [±20]	28 to 39 [50 to 70]
236 °C to 260 °C [451 °F to 500 °F]	±14 [±25]	±14 [±25]	31 to 56 [60 to 100]
	±11 [±20]	±11 [±20]	28 to 50 [50 to 90]

Table 7. 2450RC/2450RCH/2455RC Series Specifications

Characteristic	Parameter
Switch type	SPST
Reset type	automatic
Amperage	See Tables 8, 9
Voltage	120 Vac to 250 Vac
Operating temperature range	0 °C to 260 °C [32 °F to 500 °F]
Environmental exposure range	-20 °C to 287 °C [0 °F to 550 °F]
Materials:	
Base	ceramic
Contacts	silver alloy
Terminals	plated steel
Closure	aluminum, brass, or stainless steel
Brackets	stainless steel
Approvals	<ul style="list-style-type: none"> • 2450RCH: 1,59 mm [0.0625 in] clearance through air and over surface; UL File E36103; CSA File LR21048 • 2450RC: 1,59 mm [0.0625 in] clearance; UL file E36103; CSA File LR21048 • 2455RC: 6,35 mm [0.25 in] clearance; UL File E36103; CSA File LR21048
Weight	6 g [0.21 oz] (does not include brackets or wire leads)

Commercial Thermostats

Table 8. 2450RCH/2450RC Contact Ratings

Life Cycles	120 Vac	240 Vac
100,000	15 A resistive	10 A resistive
30,000	125 VA pilot duty	125 VA pilot duty

Table 9. 2455RC Contact Ratings

Life Cycles	120 Vac	240 Vac
100,000	15 A resistive	10 A resistive
100,000	4.4 FLA 26.4 LRA	2.2 FLA 13.2 LRA
100,000	125 VA pilot duty	125 VA pilot duty

Note: Additional contact ratings are available, please contact Honeywell.

Figure 5. 2450RC/2450RCH/2455RC Basic Dimensions



Figure 6. 2455RM/2450CM Series Phenolic or Ceramic Manual Reset Thermostats



The 2455RM (phenolic)/2450CM (ceramic) Series is a single pole, single throw, snap-acting, non-adjustable thermostat. A temperature-sensitive bimetal disc, electrically and thermally isolated from the switch, is used to actuate the normally-closed contacts. Contacts open when surface or ambient temperatures increase to the operating set point of the calibrated bimetal disc. The entire switch is enclosed in a housing; the bimetal disc is retained by a metal heat-conducting end cap. The circuit remains open above the room ambient temperature until the manual reset button is depressed. Due to the small size of this unit and the inherently low mass of the bimetal snap-action disc, response of this thermostat to temperature changes is extremely rapid, compared to other commercially available thermostatic devices. For increased sensitivity, an exposed bimetal disc may be specified. A variety of mounting brackets and terminals is available.

All versions are UL/CSA, European approved.

Potential applications include those where a manual reset is desired, including:

- Power supplies
- Appliances
- Medical equipment
- Water heaters
- Office automation
- Industrial equipment
- HVAC equipment

Table 10. 2455RM Series Standard Temperature Characteristics

Operating Temperature Range	Tolerance °C [°F]
52 °C to 93 °C [125 °F to 200 °F]	±5 [±8]
94 °C to 121 °C [201 °F to 250 °F]	±6 [±10]
122 °C to 150 °C [251 °F to 302 °F]	±7 [±12]

Table 11. 2450CM Series Standard Temperature Characteristics

Operating Temperature Range	Tolerance °C [°F]
52 °C to 93 °C [125 °F to 200 °F]	±5 [±8]
94 °C to 121 °C [201 °F to 250 °F]	±6 [±10]
122 °C to 149 °C [251 °F to 300 °F]	±7 [±12]
150 °C to 177 °C [301 °F to 350 °F]	±8 [±15]
177 °C to 204 °C [351 °F to 400 °F]	±10 [±18]
205 °C to 232 °C [401 °F to 450 °F]	±11 [±20]

Commercial Thermostats

Table 12. 2455RM/2450CM Series Specifications

Characteristic	Parameter
Switch type	SPST
Reset type	manual
Amperage	15 A resistive at 6,000 cycles (UL); 16 A resistive at 1000 cycles (EU)
Voltage	120 Vac to 250 Vac
Operating temperature range	2455RM: 52 °C to 150 °C [125 °F to 302 °F] 2450CM: 52 °C to 232 °C [125 °F to 450 °F]
Environmental exposure range	2455RM: -20 °C to 177 °C [0 °F to 350 °F] 2450CM: -20 °C to 260 °C [0 °F to 500 °F]
Materials:	
Base	2455RM: phenolic; 2450CM: ceramic
Contacts	silver alloy
Terminals	2455RM: unplated brass, plated brass or steel; 2450CM: plated steel
Closure	aluminum, brass, or stainless steel
Brackets	stainless steel
Approvals	UL File E36103, CSA File LR21048
Weight	6 g [0.21 oz] (does not include brackets or wire leads)

NOTICE

- 2455RM/2450CM thermostats are intended as a manual reset control. They are not to be used on applications where a limit thermostat is required unless back-up protection is provided. Units have been tested by UL for 1,000 cycles under load, 5,000 cycles no load, and are not considered as limit devices.
- This range of thermostats has an automatic reset function with manual override function.
- Reset pin operation should not be performed above 70% of set point temperature.

Table 13. 2450CM/2455RM Contact Ratings

Life Cycles	120 Vac	240 Vac
6,000	15 A resistive	10 A resistive
6,000	4.4 FLA 26.4 LRA 125 VA pilot duty	2.2 FLA 13.2 LRA 125 VA pilot duty

Note: Additional contact ratings are available, please consult Honeywell.

Figure 7. 2455RM/2455CM Basic Dimensions

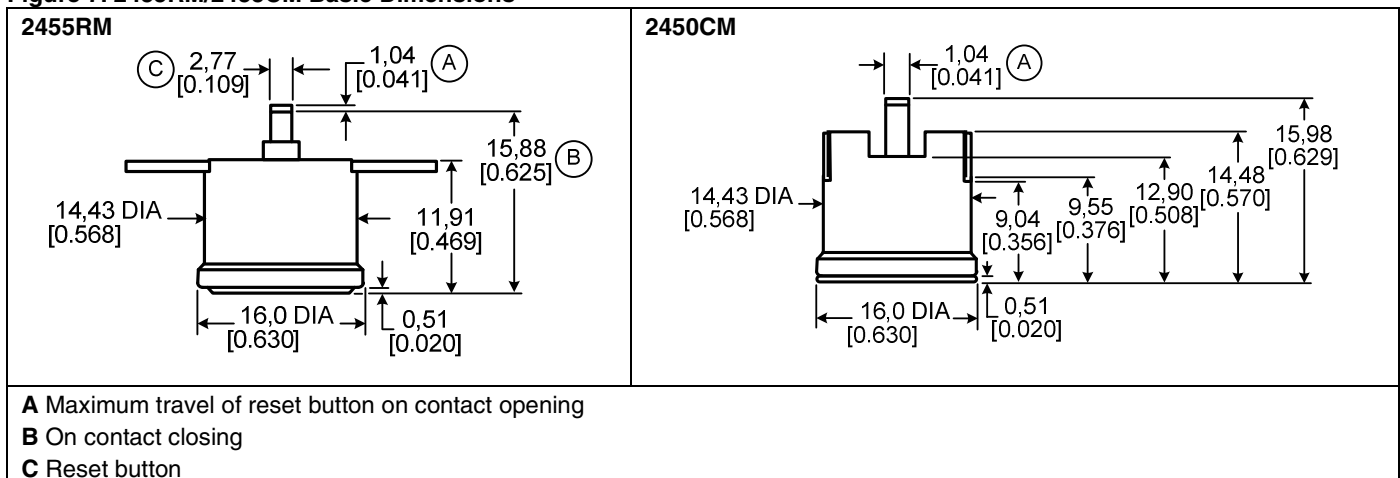

Figure 8. 2455RD Series Phenolic Manual Reset



The 2455RD Series is a single pole, single throw, snap-acting, non-adjustable thermostat. A temperature-sensitive bimetal disc, electrically and thermally isolated from the switch, is used to actuate the normally-closed contacts. Contacts open when surface or ambient temperatures increase to the operating set point of the calibrated bimetal disc. The entire switch is enclosed in a housing; the bimetal disc is retained by a metal heat-conducting end cap. The circuit remains open above the room ambient temperature until the manual reset button is depressed. (These devices are constructed with an additional steel disc so that they are manual reset only. They do not have an automatic reset.) Due to the small size of this unit and the inherently low mass of the bimetal snap-action disc, response of this thermostat to temperature changes is extremely rapid, compared to other commercially available thermostatic devices. For increased sensitivity, an exposed bimetal disc may be specified. A variety of mounting brackets and terminals is available.

All versions are UL/CSA and European approved.

Potential applications include those where a manual reset is desired, including:

- Power supplies
- Appliances
- Medical equipment
- Water heaters
- Office automation
- Industrial equipment
- HVAC equipment

Table 14. 2455RD Series Standard Temperature Characteristics

Operating Temperature Range	Tolerance °C [°F]
52 °C to 93 °C [125 °F to 200 °F]	±5 [±8]
94 °C to 121 °C [201 °F to 250 °F]	±6 [±10]
122 °C to 150 °C [251 °F to 302 °F]	±7 [±12]

Commercial Thermostats

Table 15. 2455RD Series Specifications

Characteristic	Parameter
Switch type	SPST
Reset type	manual
Amperage	15 A resistive at 6,000 cycles (UL); 16 A resistive at 1000 cycles (EU)
Voltage	120 Vac to 250 Vac
Operating temperature range	2455RD: 52 °C to 150 °C [125 °F to 302 °F]
Environmental exposure range	2455RD: -20 °C to 177 °C [0 °F to 350 °F]
Materials:	
Base	phenolic
Contacts	silver alloy
Terminals	unplated brass, plated brass or steel
Closure	aluminum, brass, or stainless steel
Brackets	stainless steel
Approvals	UL File E36103, CSA File LR21048

Table 16. 2455RD Contact Ratings

Life Cycles	120 Vac	240 Vac
6000	15 A resistive	10 A resistive

Note: Additional contact ratings are available, please consult Honeywell.

Figure 9. 2455RD Basic Dimensions



Figure 10. Series 2455RBV Overmolded Automatic Reset Thermostats

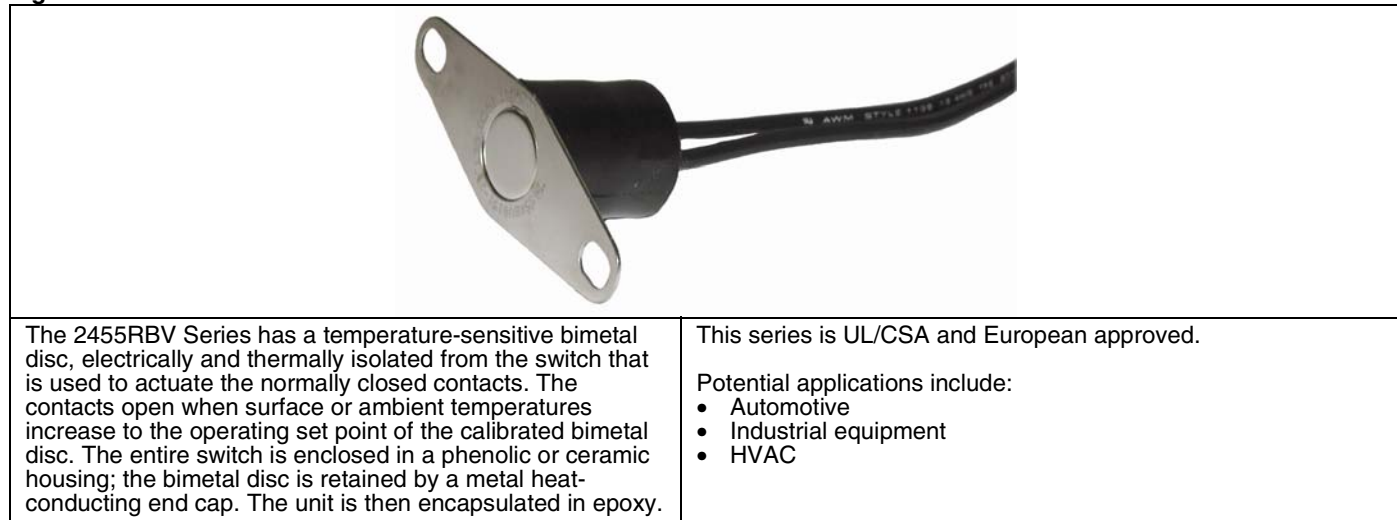

The 2455RBV Series has a temperature-sensitive bimetal disc, electrically and thermally isolated from the switch that is used to actuate the normally closed contacts. The contacts open when surface or ambient temperatures increase to the operating set point of the calibrated bimetal disc. The entire switch is enclosed in a phenolic or ceramic housing; the bimetal disc is retained by a metal heat-conducting end cap. The unit is then encapsulated in epoxy.

This series is UL/CSA and European approved.

Potential applications include:

- Automotive
- Industrial equipment
- HVAC

Table 17. 2455RBV Series Standard Temperature Characteristics

Operating Temperature Range	Tolerance		Standard Mean Differential °C [°F]
	Open °C [°F]	Close °C [°F]	
-12,2 °C to 26,7 °C [10 °F to 80 °F]	±4 [±7]	±6 [±10]	17 to 44 [30 to 80]
	±3 [±6]	±4 [±8]	14 to 28 [25 to 50]
	±3 [±5]	±4 [±8]	11 to 22 [20 to 40]
27,2 °C to 105 °C [81 °F to 221 °F]	±3 [±6]	±6 [±10]	17 to 44 [30 to 80]
	±3 [±5]	±4 [±8]	11 to 28 [20 to 50]

Commercial Thermostats

Table 18. 2455RBV Series Specifications

Characteristic	Parameter
Switch type	SPST
Reset type	automatic
Amperage	see Table 19
Voltage	120 Vac to 250 Vac
Operating temperature range	0 °C to 105 °C [32 °F to 221 °F]
Environmental exposure range	-18 °C to 126.6 °C [0 °F to 260 °F]
Materials:	
Boot	nylon, with epoxy filled or injection molded
Base	internal 2455RC ceramic or 2455R phenolic
Contacts	silver alloy
Terminals	plated steel with wires
Closure	aluminum, brass, or stainless steel
Brackets	stainless steel
Approvals	UL File SA4469, CSA File LR21048.
Weight	6.5 g [0.23 oz] (does not include brackets or wire leads)

Table 19. 2455RBV Series Contact Ratings

Life Cycles	120 Vac	240 Vac
100,000	15 A resistive	10 A resistive
6,000	5.8 FLA 34.8 LRA	2.9 FLA 17.4 LRA
100,000	4.4 FLA 26.4 LRA 125 VA pilot duty	2.2 FLA 13.2 LRA 125 VA pilot duty

Note: Additional contact ratings are available, please contact Honeywell.

Figure 11. 2455RBV Basic Dimensions



Figure 12. 2450A/2455RA Heat Detection Thermostats



The 2450A/2455RA Series is a single pole, single throw, snap-acting, non-adjustable thermostat designed for easy mounting in devices such as fire alarms, security devices and smoke detectors. A temperature-sensitive bimetal disc, electrically and thermally isolated from the switch, is used to actuate the normally-closed contacts. Contacts open when surface or ambient temperatures increase to the operating set point of the calibrated bimetal disc. Devices are UL recognized and designed for use in both photoelectric and ionization type smoke detectors. Thermostats are available with and without collectors and meet UL spacing requirements for 15 ft, 30 ft and 50 ft. They are available to open or close on a temperature rise of 47 °C [117 °F] to 107 °C [225 °F]. Devices feature gold contacts for low voltage requirements and are epoxy sealed at the cap and terminal for long storage life of the application. Collectors are available in silver, black, beige, gold or bronze finishes.

All versions are UL approved.

Potential applications:

- Smoke alarm/heat detectors in industrial, residential and commercial

NOTICE

Final approval of a fire detection system is determined by UL as outlined in UL #521 and UL #217 for the suitability of the combination of the thermostat (2450A/2455RA) and the user's mounting base, together with its intended application of the total fire detection system. To assist the use with design and testing, a minimum of 0.25 in extension beyond the housing is recommended.

Table 20. 2450A/2455RA Series Standard Temperature Characteristics

Detection (Close on Rise)		Release (Open on Rise)	
Close °C [°F]	Open °C [°F]	Open °C [°F]	Close °C [°F]
47 ±3 [117±5]	30 min [85 min]	57 ±3 [117 ±5]	30 min [85 min]
57 ±3 [135 ±5]	32 min [90 min]	57 ±3 [135 ±5]	32 min [90 min]
69 ±3 [156 ±5]	32 min [90 min]	69 ±3 [156 ±5]	32 min [90 min]
85 ±4 [185 ±7]	32 min [90 min]	85 ±4 [185 ±7]	32 min [90 min]
107 ±4 [225 ±7]	32 min [90 min]	107 ±4 [225 ±7]	32 min [90 min]

Notes:

- Additional switches can be provided as long as they fall between 47,2 °C to 107,2 °C [117 °F to 225 °F] close on rise or open or rise.
- Please consult Honeywell for tolerances and temperatures not listed.

Commercial Thermostats

Table 21. 2450A/2455RA Series Specifications

Characteristic	Parameter
Switch type	SPST
Reset type	automatic
Amperage	3 A
Voltage	120 Vac
Operating temperature range	47,2 °C to 107,2 °C [117 °F to 225 °F]
Environmental exposure range	-0 °C to 150 °C [32 °F to 302 °F]
Materials:	
Base	phenolic
Contacts	gold flash
Terminals	unplated brass, plated brass
Closure	aluminum
Brackets	aluminum
Approvals	UL File S1015 and S1389; Guide USCV2 and TAOZ2, UL Standard #521, #217
Weight	6 g [0.21 oz] (does not include brackets)

Figure 13. 2450A/2455RA Basic Dimensions



Figure 14. 2450A/2455RA Collector

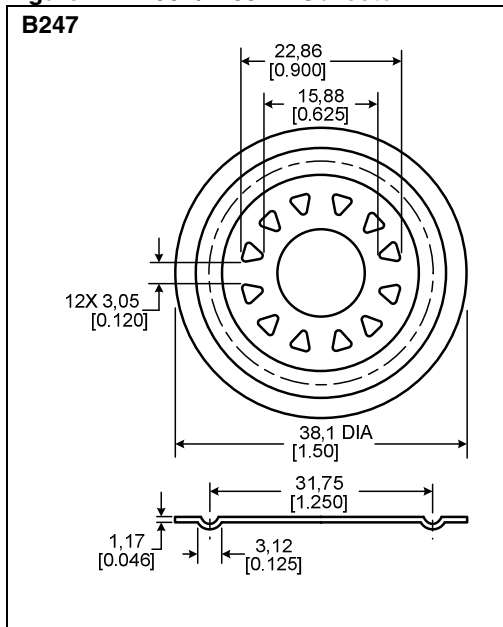
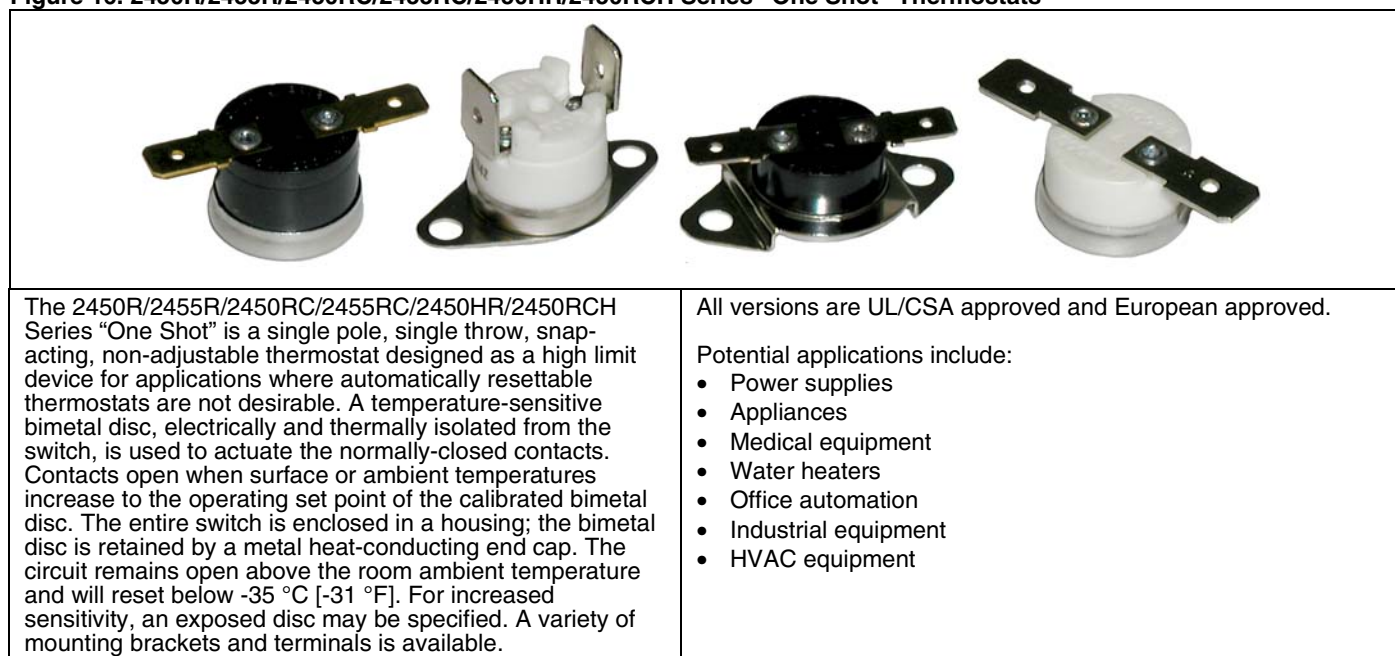

Figure 15. 2450A and 2455RA Spacing



Figure 16. 2450R/2455R/2450RC/2455RC/2450HR/2450RCH Series “One Shot” Thermostats



The 2450R/2455R/2450RC/2455RC/2450HR/2450RCH Series “One Shot” is a single pole, single throw, snap-acting, non-adjustable thermostat designed as a high limit device for applications where automatically resettable thermostats are not desirable. A temperature-sensitive bimetal disc, electrically and thermally isolated from the switch, is used to actuate the normally-closed contacts. Contacts open when surface or ambient temperatures increase to the operating set point of the calibrated bimetal disc. The entire switch is enclosed in a housing; the bimetal disc is retained by a metal heat-conducting end cap. The circuit remains open above the room ambient temperature and will reset below -35 °C [-31 °F]. For increased sensitivity, an exposed disc may be specified. A variety of mounting brackets and terminals is available.

All versions are UL/CSA approved and European approved.

Potential applications include:

- Power supplies
- Appliances
- Medical equipment
- Water heaters
- Office automation
- Industrial equipment
- HVAC equipment

Table 22. 2450R/2455R/2450RC/2455RC/2450HR/2450RCH Series “One Shot” Standard Temperature Characteristics

Operating Temperature Range	Tolerance °C [°F]
52 °C to 93 °C [125 °F to 200 °F]	5 [8]
94 °C to 121 °C [201 °F to 250 °F]	6 [10]
122 °C to 149 °C [251 °F to 300 °F]	7 [12]
150 °C to 177 °C [301 °F to 350 °F]	8 [15]
177 °C to 204 °C [351 °F to 400 °F]	10 [18]
205 °C to 232 °C [401 °F to 450 °F]	11 [20]
232 °C to 260 °C [451 °F to 500 °F]	14 [25]

Commercial Thermostats

Table 23. 2450R/2455R/2450RC/2455RC/2450HR/2450RCH Series “One Shot” Specifications

Characteristic	Parameter
Switch type	SPST
Reset type	One Shot
Amperage	see Table 24
Voltage	120 Vac to 250 Vac
Operating temperature range	2450R/2455R/2450HR/2450RCH: 52 °C to 150 °C [125 °F to 302 °F] 2450RC/2455RC: 52 °C to 260 °C [125 °F to 500 °F]
Environmental exposure range	2450R/2455R/2450HR/2450RCH: 17.8 °C to 177 °C [0 °F to 350 °F] 2450RC/2455RC: 17.8 °C to 287 °C [125 °F to 550 °F]
Materials:	
Base	phenolic or ceramic
Contacts	silver alloy
Terminals	unplated brass, plated brass or steel
Closure	aluminum, brass, stainless steel
Brackets	stainless steel
Approvals	UL File E36103, CSA File LR43279
Weight	6 g [0.21 oz] (does not include brackets or lead wires)

Table 24. 2450R/2455R/2450RC/2455RC/2450HR/2450RCH Series “One Shot” Contact Ratings

Cycles	120 Vac	240 Vac	277 Vac
1	15 A resistive	10 A resistive	10 A resistive

Notes:

- Resets below -35 °C [-31 °F].
- Additional contact ratings are available. Please consult Honeywell.

Figure 17. 2450R/2455R/2450RC/2455RC/2450HR/2450RCH Series “One Shot” Basic Dimension



REDI-TEMP THERMOSTATS

REDI-TEMP thermostats are pre-configured as shown and are readily available.

Figure 18. 3455RC REDI-TEMP Series (See page 6 for specifications and potential applications.)



Table 25. 3455RC REDI-TEMP Series Open on Rise

Catalog Listing	Open Temp. °C [°F]	Open Tolerance °C [°F]	Close Temp. °C [°F]	Close Tolerance °C [°F]
3455RC-100-220	18 [65]	±3 [±5]	-1 [30]	±5 [±8]
3455RC-100-221	24 [75]	±3 [±5]	4 [40]	±5 [±8]
3455RC-100-222	29 [85]	±3 [±5]	13 [55]	±5 [±8]
3455RC-100-223	35 [95]	±3 [±5]	18 [65]	±5 [±8]
3455RC-100-224	41 [105]	±3 [±5]	24 [75]	±5 [±8]
3455RC-100-225	46 [115]	±3 [±5]	29 [85]	±5 [±8]
3455RC-100-226	52 [125]	±3 [±5]	35 [95]	±5 [±8]
3455RC-100-227	57 [135]	±3 [±5]	41 [105]	±5 [±8]
3455RC-100-228	63 [145]	±3 [±5]	46 [115]	±5 [±8]
3455RC-100-229	68 [155]	±3 [±5]	52 [125]	±5 [±8]
3455RC-100-230	73 [165]	±3 [±5]	57 [135]	±5 [±8]
3455RC-100-231	79 [175]	±3 [±5]	63 [145]	±5 [±8]
3455RC-100-232	85 [185]	±3 [±5]	68 [155]	±5 [±8]
3455RC-100-233	91 [195]	±3 [±5]	73 [165]	±5 [±8]
3455RC-100-234	96 [205]	±4 [±6]	79 [175]	±5 [±8]
3455RC-100-235	102 [215]	±4 [±6]	85 [185]	±5 [±8]
3455RC-100-236	107 [225]	±4 [±6]	91 [195]	±5 [±8]
3455RC-100-237	113 [235]	±4 [±6]	96 [205]	±5 [±8]
3455RC-100-238	118 [245]	±4 [±6]	102 [215]	±5 [±8]
3455RC-100-239	124 [255]	±4 [±7]	107 [225]	±5 [±8]
3455RC-100-240	135 [275]	±4 [±7]	118 [245]	±5 [±8]
3455RC-100-241	146 [295]	±4 [±7]	129 [265]	±5 [±8]
3455RC-100-242	157 [315]	±6 [±10]	135 [275]	±8 [±15]

Table 26. 3455RC REDI-TEMP Series Close on Rise

Catalog Listing	Close Temp. °C [°F]	Close Tolerance °C [°F]	Open Temp. °C [°F]	Open Tolerance °C [°F]
3455RC-100-243	21 [70]	±5 [±8]	2 [35]	±3 [±5]
3455RC-100-244	32 [90]	±5 [±8]	16 [60]	±3 [±5]
3455RC-100-245	43 [110]	±5 [±8]	27 [80]	±3 [±5]
3455RC-100-246	54 [130]	±5 [±8]	38 [100]	±3 [±5]
3455RC-100-247	66 [150]	±5 [±8]	49 [120]	±3 [±5]
3455RC-100-248	77 [170]	±5 [±8]	60 [140]	±3 [±5]
3455RC-100-249	88 [190]	±5 [±8]	71 [160]	±3 [±5]
3455RC-100-250	99 [210]	±5 [±8]	82 [180]	±4 [±6]
3455RC-100-251	110 [230]	±5 [±8]	93 [200]	±4 [±6]

Note: Materials and contact ratings are the same as those for 2455RC.

Commercial Thermostats

MOUNTING HARDWARE

Figure 19. Brackets



Figure 19. Brackets (Continued)



Figure 20. Brass Mounting Studs



Commercial Thermostats

Figure 21. Terminals

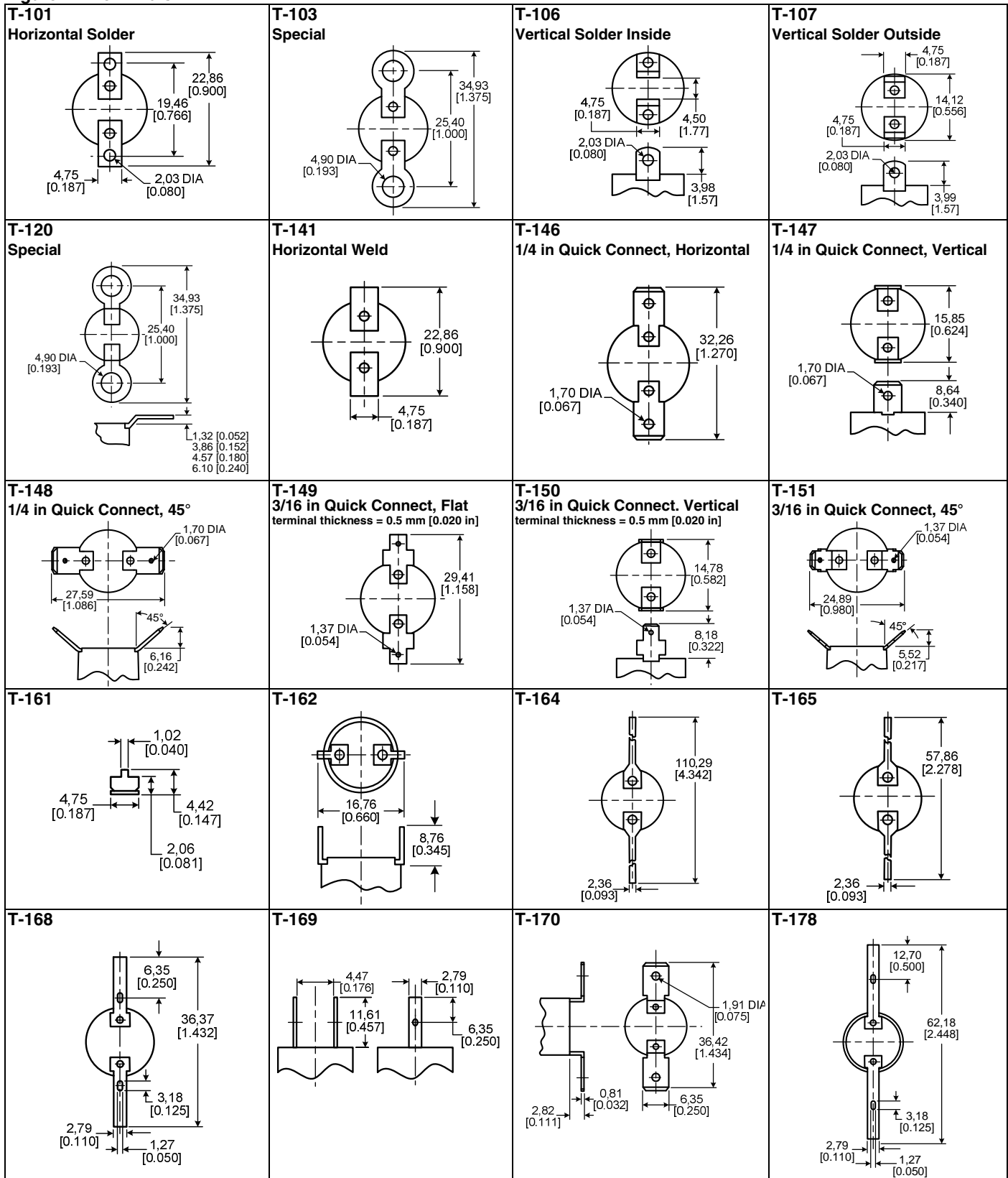

Figure 21. Terminals (Continued)

