

SERPAC 273R (3D exploded)

Electronic Enclosures

- Click on image to show toolbar. Use  to Play/Pause Animation.
- Left click and drag on image to move 3D model.

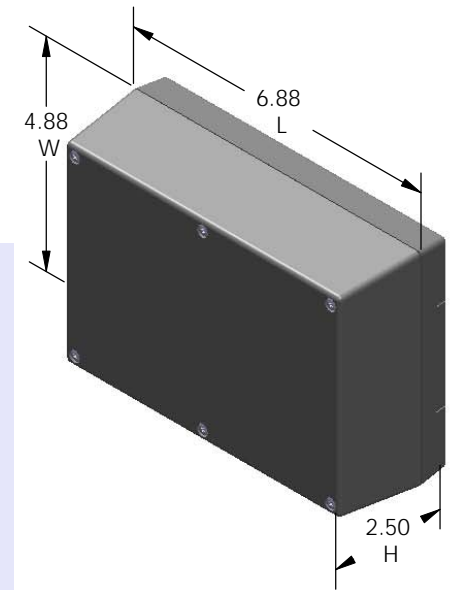
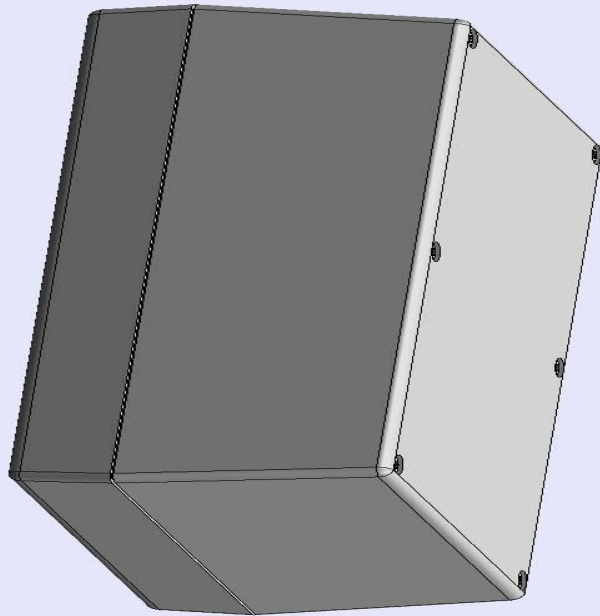

Threaded inserts only have to be assembled the first time.

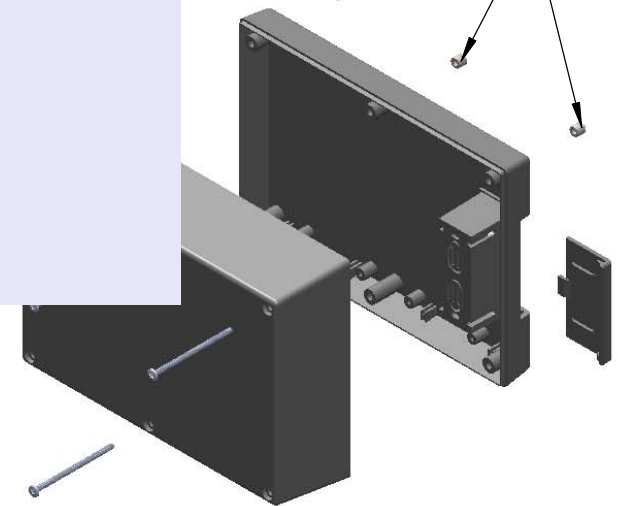

- a) Zoom in & out with center wheel.
- b) Pause at any moment to view and or print views.
- c) Change the views to ortho and section views if needed from the Views pull down menu.
- d) Explore options included in the tool bar like: Views, Transparency of model, Lighting type, etc.

PART NO.	DESCRIPTION (Included)	ACCESSORIES (Optional)	
7-3R	TOP	PART NO.	DESCRIPTION
27	BOTTOM	50	Non-skid Feet
1025	Battery Cover	379	Prototype grid board (bottom)
6019	4-40 Screws (6)	479	Prototype clad board (bottom)
6102	Threaded Inserts (6)		

Notes: Enclosure weight .51 lbs / 233 gm

- 1) Enclosure meets or exceeds IP40 and NEMA 1
- 2) Circuit Board drawings can be download at:

TOP: http://www.serpac.com/Accessories/CircuitBoard/drawings/X73_CB.pdf

BOTTOM: <http://www.serpac.com/Accessories/CircuitBoard/drawings/379-479-cbg.pdf>

- 3) All components are RoHS Compliant.

ALL DIMENSIONS ARE ±.010" 8/05/10 (1 of 2)
 2009 Wright Ave. La Verne, CA 91750
 Ph. (626) 331-0517 Fx. (626) 331-8584 serpac.com

SERPAC 273R (user print)

Electronic Enclosures

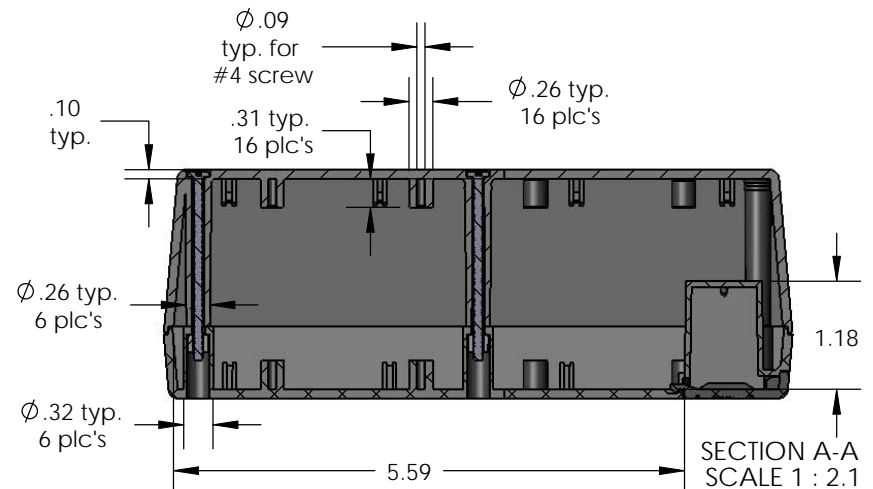
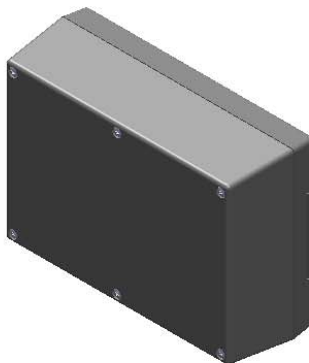
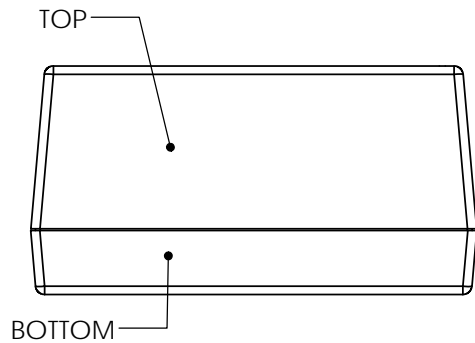
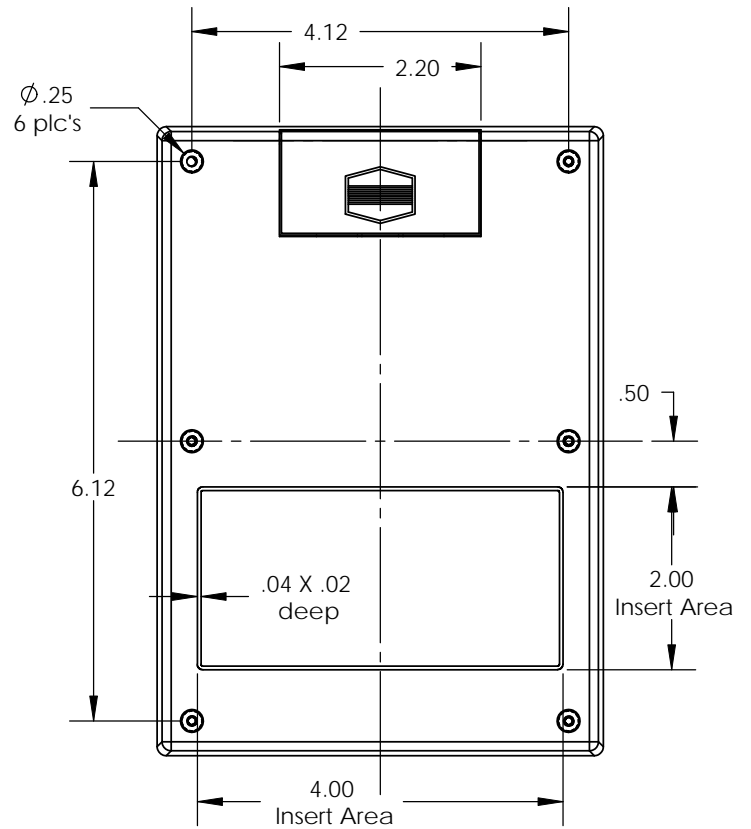
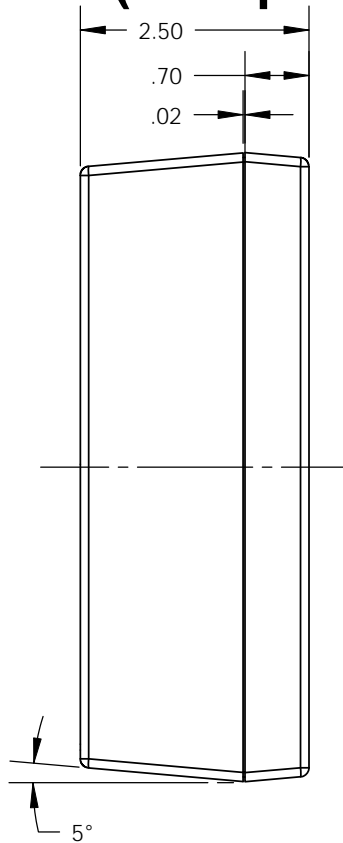
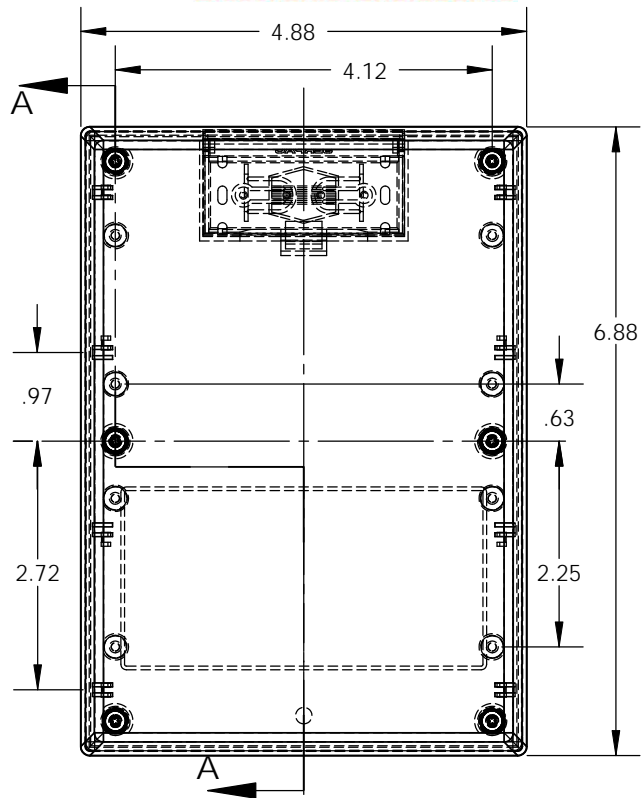

PART NO.	DESCRIPTION (Included)	ACCESSORIES (Optional)	
7-3R	TOP	PART NO.	DESCRIPTION
27	BOTTOM	50	Non-skid Feet
1025	Battery Cover	379	Prototype grid board (bottom)
6019	4-40 Screws (6)	479	Prototype clad board (bottom)
6102	Threaded Inserts (6)		

Notes: Enclosure weight .51 lbs / 233 gm
 1) Enclosure meets or exceeds IP40 and NEMA 1
 2) Circuit Board drawings can be download at:
 TOP:
http://www.serpac.com/Accessories/CircuitBoard/drawings/X73_CB.pdf
 BOTTOM:
<http://www.serpac.com/Accessories/CircuitBoard/drawings/379-479-cbg.pdf>
 3) All components are RoHS Compliant.

ALL DIMENSIONS ARE ± .010" 8/05/10 (2 of 2)
 2009 Wright Ave. La Verne, CA 91750
 Ph. (626) 331-0517 Fx. (626) 331-8584 www.serpac.com