

SCALE DRAWING 1:1

 28M0197-000

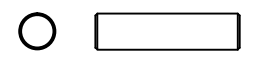
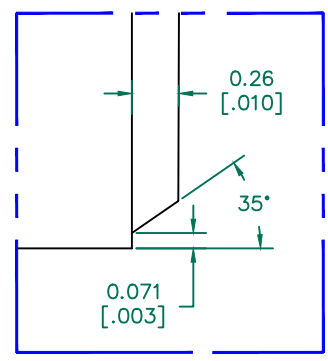
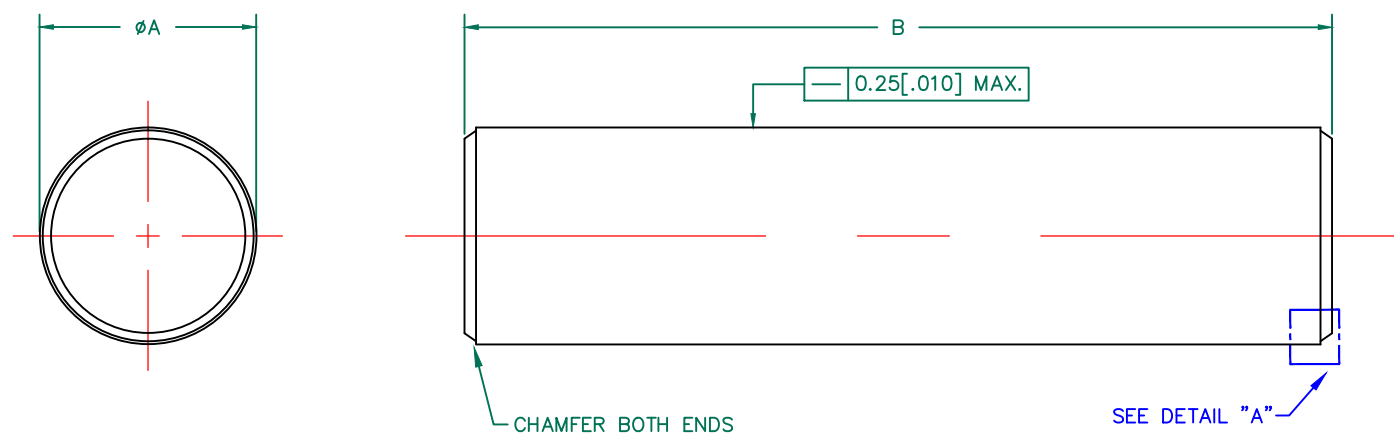

DETAIL "A"
 SCALE: 50 : 1

BARE DIMENSIONS:

A	5.00 [.197]	+	0.25 [.010]
B	20.00 [.843]	+	0.50 [.020]

WEIGHT/K 1.90 kgs 4.19 lbs.

NOTES:

- Cosmetic specification refer to WI-QA-038.

DIMENSIONS ARE IN mm [INCHES].				This print is the property of Laird Tech. and is loaned in confidence subject to return upon request and with the understanding that no copies shall be made without the written consent of Laird Tech. All rights to design or invention are reserved.				
				PROJECT/PART NUMBER:	REV	PART TYPE:	DRAWN BY:	
				28M0197-000	A	ROD	QIU	
				DATE:	SCALE:	MATERIAL:		
				06/20/14	NTS	FERRITE		
				CAD #	TOOL #			
				28M0197-000-A	6:1			
REV	DESCRIPTION	DATE	INT					
A	ORIGINAL DRAFT	06/20/14	QIU					