

PART NUMBER	ITEM ① SLEEVE	ITEM ② CONTACT	ITEM ③ BODY
29-4030	BRASS NICKEL PLATED	BERYLLIUM GOLD PLATED	BRASS NICKEL PLATED

受控 CONTROLLED DOCUMENT

编号 P/N	29-4030	版本 Rev	0B	日期 Rel'd Date	Mar 24, 08
-----------	---------	-----------	----	------------------	------------

DRAWING NO. 29-4030	
REVISIONS	
RELEASE FOR QUATION	
A	12-30-05 W W T
CHANGE SOME TOL. ADD NOTES 4 & 5	
B	12-26-06 Z L T

Thomas
2007.01.04
14:16:33

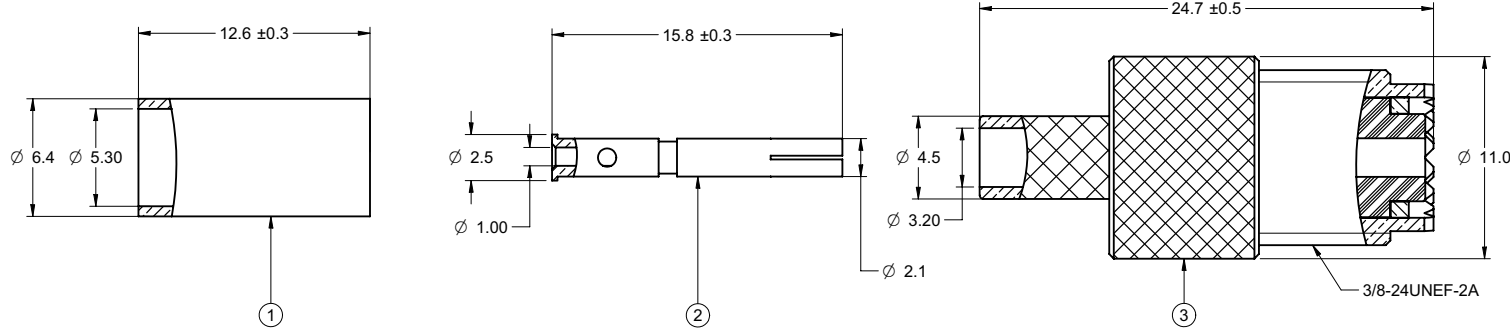

NOTES:

- ELECTRICAL CHARACTERISTICS**
 IMPEDANCE: NON-CONSTANT
 FREQUENCY RANGE: 0-2 GHZ
 WORKING VOLTAGE: 500 VOLTS RMS AT SEA LEVEL
 DIELECTRIC WITHSTANDING VOLTAGE: 1500 VOLTS RMS AT SEA LEVEL
 INSULATION RESISTANCE: 5000 MEGOHMS MINIMUM
- ENVIRONMENTAL CHARACTERISTICS**
 RECOMMENDED TEMPERATURE RANGE: -55°C TO +85°C
- MECHANICAL CHARACTERISTICS**
 DURABILITY: 500 CYCLES
 CABLE RETENTION: 20 LBS., RG-58 C/U CABLE
- PRODUCT SHOULD BE ROHS COMPLIANCE.**
- PACKAGING REQUIREMENT FOLLOWS ENGINEERING DOCUMENT**
 P/N 836-40200001XX

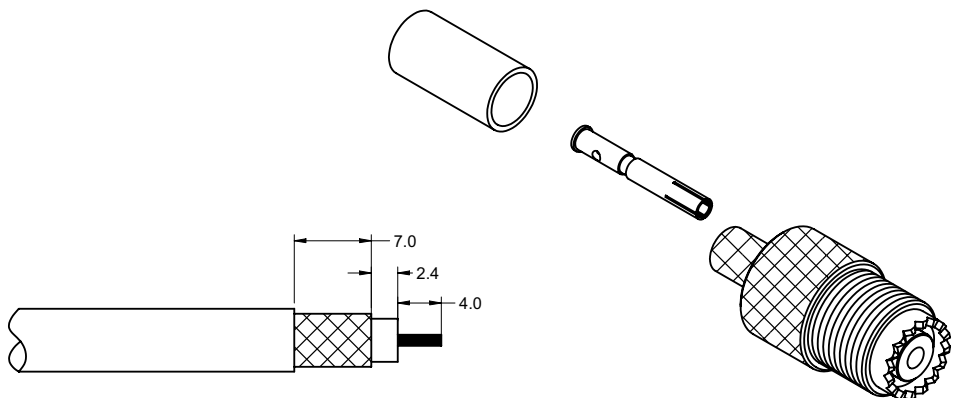

CABLE STRIP DIMENSIONS
 ASSEMBLY INSTRUCTIONS ON SHEET 2

THIS DRAWING TO BE INTERPRETED
 PER ANSI Y 14.5M - 1994
COMPANY CONFIDENTIAL

TOLERANCE UNLESS OTHERWISE SPECIFIED		DRAWN BY GARY.ZHG	DATE 12-26-06
DECIMALS	mm	CHECKED BY LINDA.WU	DATE 12-26-26
X	± 0.5	APPROVED BY THOMAS	DATE 12-26-06
X.X	± 0.2	U/M	mm
X.XX	± 0.1		
ANGLES	± 0.5°		

EMERSON
 Network Power

Connectivity Solutions

TITLE
 MINI UHF 3 PC CRIMP FEMALE

SHEET 1 OF 2	DRAWING NO. 29-4030	SIZE C
-----------------	------------------------	-----------

THIS DRAWING WAS PRODUCED BY COMPUTER,
 DO NOT SCALE DRAWING OR UPDATE MANUALLY.

PART NUMBER	CABLE TYPE	BLISTER NO.	AIM TOOL
29-4030	RG-58	29-4030P	24-9958P

DRAWING NO. 29-4030			
REVISIONS			
A RELEASE FOR QUOTATION			
12-30-05	W	W	T
VERSION UPDATE			
B 12-26-06 Z L T			

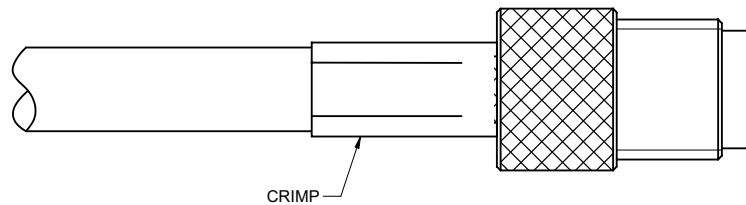
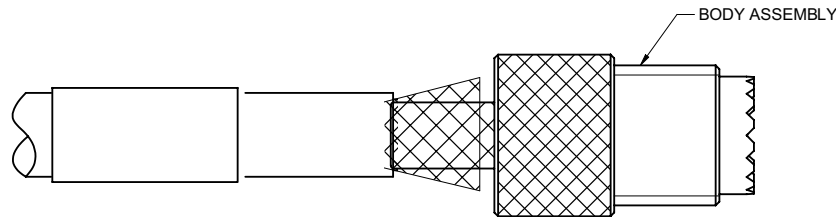
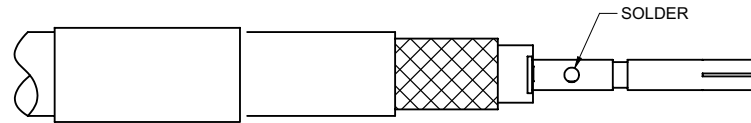
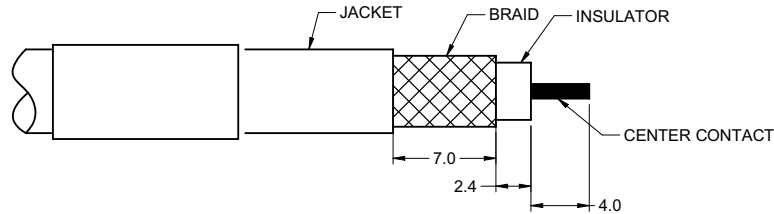
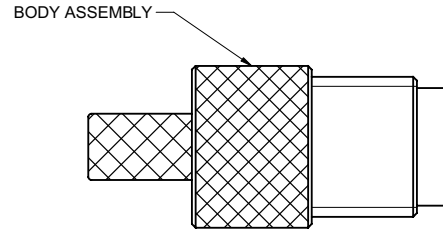
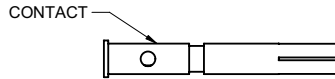
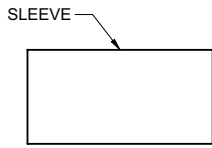

ASSEMBLY INSTRUCTIONS

1. STRIP CABLE TO DIMENSIONS SHOWN IN TABLE. ALL CUTS ARE TO BE SHARP AND SQUARE. IMPORTANT: DO NOT NICK BRAID, DIELECTRIC, OR CENTER CONDUCTOR.
2. SLIDE OUTER FERRULE ONTO CABLE AS SHOWN. FLARE SLIGHTLY END OF CABLE BRAID AS SHOWN TO FACILITATE INSERTION OF INNER FERRULE. IMPORTANT: DO NOT COMB OUT BRAID. PLACE CONTACT ON CABLE CENTER CONDUCTOR SO IT BUTTS AGAINST CABLE DIELECTRIC. SOLDER CONTACT IN PLACE USING TOOL.
3. INSTALL CABLE ASSEMBLY INTO BODY ASSEMBLY SO INNER FERRULE PORTION SLIDES UNDER BRAID. PUSH CABLE ASSEMBLY FORWARD UNTIL CABLE DIELECTRIC SEATS AGAINST CONNECTOR INSULATOR.
4. SLIDE OUTER FERRULE OVER BRAID AND UP AGAINST CONNECTOR BODY, HOLDING CONNECTOR BODY FIRMLY IN PLACE. CRIMP OUTER FERRULE USING TOOL HANDLE.

受控 CONTROLLED DOCUMENT					
编号 P/N	29-4030	版本 Rev	0B	日期 Rel'd Date	Mar 24,08

TOLERANCE UNLESS OTHERWISE SPECIFIED		DRAWN BY	DATE
DECIMALS	mm	GARY.ZHG	12-26-06
X	± 0.5	CHECKED BY	DATE
X.X	± 0.2	LINDA.WU	12-26-06
X.XX	± 0.1	APPROVED BY	DATE
ANGLES	± 0.5°	THOMAS	12-26-06
	U/M	mm	

THIS DRAWING WAS PRODUCED BY COMPUTER, DO NOT SCALE DRAWING OR UPDATE MANUALLY.

EMERSON Network Power		Connectivity Solutions	
TITLE			
MINI UHF 3 PC CRIMP FEMALE			
SHEET	DRAWING NO.	SIZE	
2 OF 2	29-4030	C	

THIS DRAWING TO BE INTERPRETED PER ANSI Y 14.5M - 1994

COMPANY CONFIDENTIAL