

**6 Pole
With Ground**
PROTECTION
IP65
RATING
E307105
CE

**Component
Parts**

Pre-Assembled Units

Covers

Bulkhead Housing



29130



403090

**FEMALE
Insert**



29120

Hood



29132
29132M



403095
403095M



29644

**Surface Mount
Housing**



Standard Part Numbers
are NPT threads.
Part numbers with an "M"
are metric thread.

1 Hole
29133
29133M

2 Hole
29134
29134M

1 Hole
403096
403096M

2 Hole
403098
403098M

**MALE
Insert**

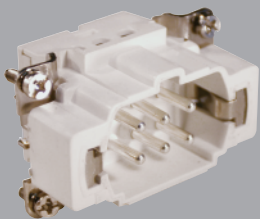

29121

Hood



29131
29131M



403093
403093M



29646



Connectors should not be coupled
and decoupled under electrical load.

Inserts

Number of contacts	6 Pole w/ ground
Electrical data to DIN EN61 984	16A 400V 6KV 3
Current	16A
Voltage	400V
Rated Impulse Voltage	6KV
Insulation Resistance	≥10 ¹⁰ Ω
Temperature Range	-40 to 125°C
Flammability	UL94-V0

Contacts

Screw terminal	
Material	Copper alloy
Surface plated	hard-silver
Contact resistance	≤ 1m Ω
Wire size	2.5mm ² / 14 AWG
Torque	0.5Nm
Stripping Length	7.5mm

Metal Hoods & Housings

Material	Aluminum
Surface	Powder coated
Seals	NBR
Degree of Protection Acc To	
DIN EN60529 for coupled connectors	IP65
Thread Size	NPT 1/2" or M20

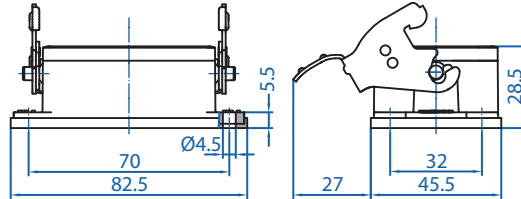

29130

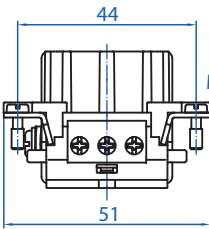

29120

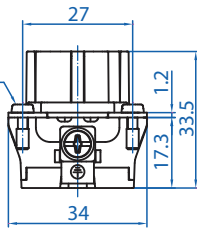

29132

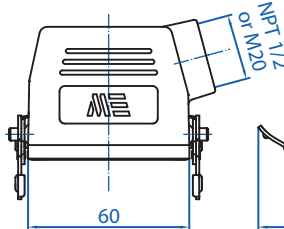

29644

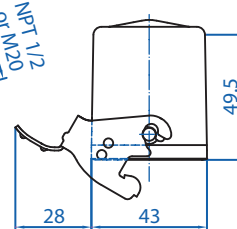

29133

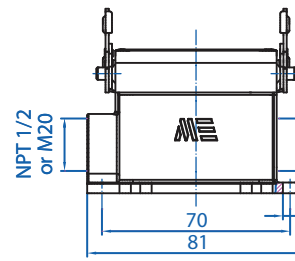
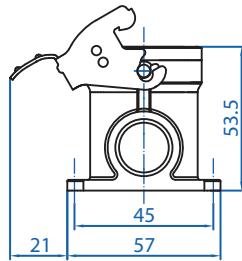
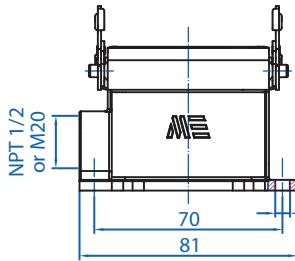
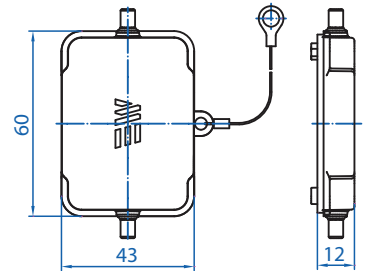

29134

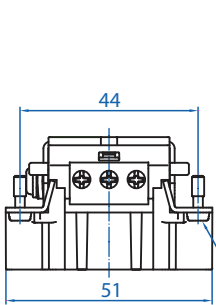
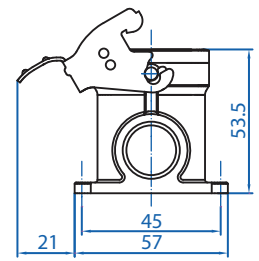

29121

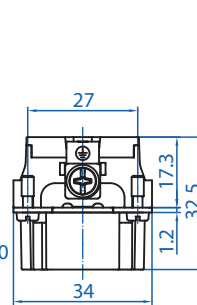

29131

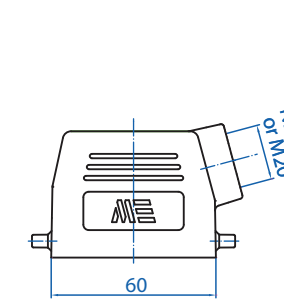

29646

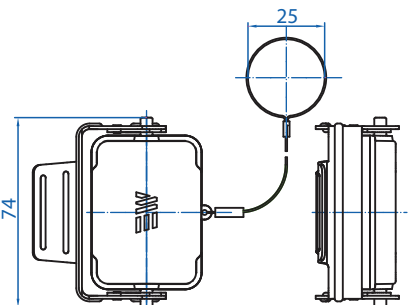
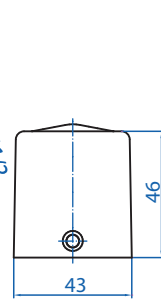

Connectors should not be coupled and decoupled under electrical load.

All dimensions are shown in millimeters. To convert to inches divide by 25.4.