

2N2608, 2N2609 P-Channel JFET

Features

- InterFET [P0032F Geometry](#)
- Typical Noise: 10 nV/√Hz
- Low Ciss: 3.2pF Typical
- RoHS Compliant
- SMT, TH, and Bare Die Package options.

Applications

- Choppers
- Data Switches
- Commutators

Description

The 30V InterFET 2N2608 and 2N2609 are targeted for data switches and low-level chopper designs. Gate leakages are typically less than 1nA at room temperatures. The TO-18 package is hermetically sealed and suitable for military applications.

TO-18 Bottom View

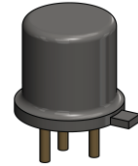
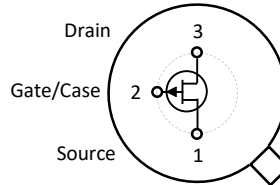

SOT23 Top View

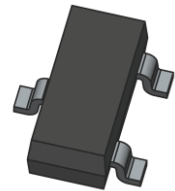
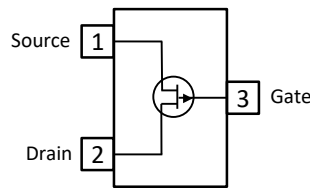

TO-92 Bottom View

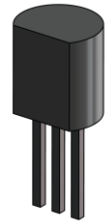
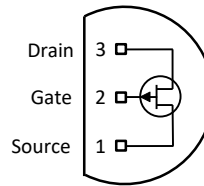

Product Summary

Parameters	2N2608 Min	2N2609 Min	Unit
BV_{GSS} Gate to Source Breakdown Voltage	30	30	V
I_{DSS} Drain to Source Saturation Current	-0.9	-2	mA
$V_{GS(off)}$ Gate to Source Cutoff Voltage	1	1	V
G_{FS} Forward Transconductance	1000	2500	μS

Ordering Information

Part Number	Description	Case	Packaging
2N2608; 2N2609	Through-Hole	TO-18	Bulk
PN2608; PN2609	Through-Hole	TO-92	Bulk
SMP2608; SMP2609	Surface Mount	SOT23	Bulk
SMP2608TR; SMP2609TR	7" Tape and Reel: Max 3,000 Pieces 13" Tape and Reel: Max 9,000 Pieces	SOT23	Minimum 1,000 Pieces Tape and Reel
2N2608COT; 2N2609COT	Chip Orientated Tray (COT Waffle Pack)	COT	400/Waffle Pack
2N2608CFT; 2N2609CFT	Chip Face-up Tray (CFT Waffle Pack)	CFT	400/Waffle Pack



Disclaimer: It is the Buyers responsibility for designing, validating and testing the end application under all field use cases and extreme use conditions. Guaranteeing the application meets required standards, regulatory compliance, and all safety and security requirements is the responsibility of the Buyer. These resources are subject to change without notice.

Electrical Characteristics

Maximum Ratings (@ $T_A = 25^\circ\text{C}$, Unless otherwise specified)

Parameters	Value	Unit
V_{RGS} Reverse Gate Source and Gate Drain Voltage	30	V
I_{FG} Continuous Forward Gate Current	-10	mA
P_D Continuous Device Power Dissipation	300	mW
P Power Derating	2	mW/ $^\circ\text{C}$
T_J Operating Junction Temperature	-55 to 125	$^\circ\text{C}$
T_{STG} Storage Temperature	-65 to 150	$^\circ\text{C}$

Static Characteristics (@ $T_A = 25^\circ\text{C}$, Unless otherwise specified)

Parameters	Conditions	2N2608		2N2609		Unit
		Min	Max	Min	Max	
$V_{(BR)GSS}$ Gate to Source Breakdown Voltage	$V_{DS} = 0V, I_G = 1\mu\text{A}$	30		30		V
I_{GSS} Gate to Source Reverse Current	$V_{GS} = 5V, V_{DS} = 0V$		10		10	nA
$V_{GS(OFF)}$ Gate to Source Cutoff Voltage	$V_{DS} = -5V, I_D = -1\text{nA}$	1	4	1	4	V
I_{DSS} Drain to Source Saturation Current	$V_{GS} = 0V, V_{DS} = -5V$ (Pulsed)	-0.9	-4.5	-2	-10	mA

Dynamic Characteristics (@ $T_A = 25^\circ\text{C}$, Unless otherwise specified)

Parameters	Conditions	2N2608		2N2609		Unit
		Min	Max	Min	Max	
G_{FS} Forward Transconductance	$V_{DS} = -5V, V_{GS} = 0V, f = 1\text{kHz}$	1000		2500		μS
C_{iss} Input Capacitance	$V_{DS} = -5.4V, V_{GS} = 1V, f = 1\text{MHz}$		17		30	pF

SOT23 (TO-236AB) Mechanical and Layout Data

Package Outline Data



1. All linear dimensions are in millimeters.
2. Package weight approximately 0.12 grams
3. Molded plastic case UL 94V-0 rated
4. For Tape and Reel specifications refer to InterFET CTC-021 Tape and Reel Specification, Document number: IF39002
5. Bulk product is shipped in standard ESD shipping material
6. Refer to JEDEC standards for additional information.

Suggested Pad Layout



1. All linear dimensions are in millimeters.
2. The suggested land pattern dimensions have been provided for reference only. A more robust pattern may be desired for wave soldering.

TO-18 Mechanical and Layout Data

Package Outline Data

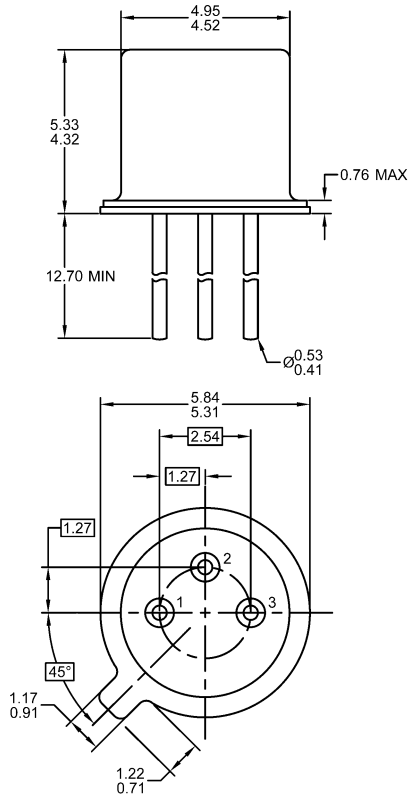

1. All linear dimensions are in millimeters.
2. Package weight approximately 0.29 grams
3. Bulk product is shipped in standard ESD shipping material
4. Refer to JEDEC standards for additional information.

Suggested Through-Hole Layout

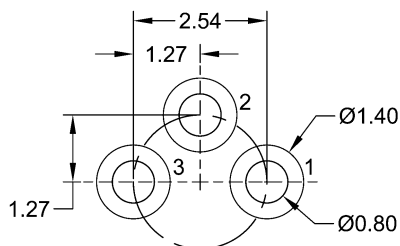

1. All linear dimensions are in millimeters.
2. The suggested land pattern dimensions have been provided as a straight lead reference only. A more robust pattern may be desired for wave soldering and/or bent lead configurations.