

2N4867/A, 2N4868/A, 2N4869/A N-Channel JFET

Features

- InterFET [N0016H Geometry](#)
- Typical Noise: 5 nV/√Hz
- Typical Ciss: 3.5pF
- Low Cutoff Voltage: 2N4867 < 2.0V
- RoHS Compliant
- SMT, TH, and Bare Die Package options.

Applications

- Audio Amplifiers
- Small Signal Amplifier
- Ultrahigh Impedance Pre-Amplifier

Description

The -50V InterFET 2N4867/A, 2N4868/A, and 2N4869/A are targeted for Audio and sensitive amplifier stages for mid-frequencies designs. Gate leakages are typically less than 10pA at room temperatures. The 2N4867/A has a cutoff voltage of less than 2.0V ideal for low-level power supplies. The TO-72 package is hermetically sealed and suitable for military applications.

TO-72 Bottom View

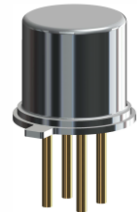
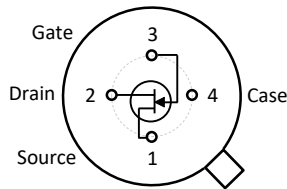

SOT23 Top View

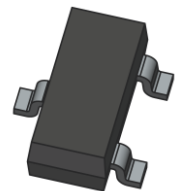
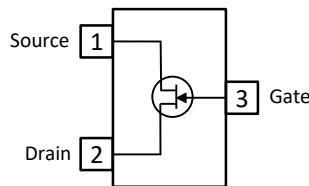

TO-92 Bottom View

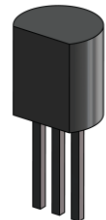
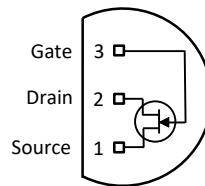

Product Summary

Parameters	2N4867/A Min	2N4868/A Min	2N4869/A Min	Unit
BV _{GSS} Gate to Source Breakdown Voltage	-40	-40	-40	V
I _{DSS} Drain to Source Saturation Current	0.4	1	2.5	mA
V _{GS(off)} Gate to Source Cutoff Voltage	-0.7	-1	-1.8	V
G _{FS} Forward Transconductance	700	1000	1300	μS

Ordering Information Custom Part and Binning Options Available

Part Number	Description	Case	Packaging
2N4867; 2N4868; 2N4869 2N4867A; 2N4868A; 2N4869A	Through-Hole	TO-72	Bulk
PN4867; PN4868; PN4869 PN4867A; PN4868A; PN4869A	Through-Hole	TO-92	Bulk
SMP4867; SMP4868; SMP4869 SMP4867A; SMP4868A; SMP4869A	Surface Mount	SOT23	Bulk
SMP4867TR; SMP4868TR; SMP4869TR SMP4867ATR; SMP4868ATR; SMP4869ATR	7" Tape and Reel: Max 3,000 Pieces 13" Tape and Reel: Max 9,000 Pieces	SOT23	Minimum 1,000 Pieces Tape and Reel
2N4867COT; 2N4868COT; 2N4869COT 2N4867ACOT; 2N4868ACOT; 2N4869ACOT	Chip Orientated Tray (COT Waffle Pack)	COT	400/Waffle Pack
2N4867CFT; 2N4868CFT; 2N4869CFT 2N4867ACFT; 2N4868ACFT; 2N4869ACFT	Chip Face-up Tray (CFT Waffle Pack)	CFT	400/Waffle Pack



Disclaimer: It is the Buyers responsibility for designing, validating and testing the end application under all field use cases and extreme use conditions. Guaranteeing the application meets required standards, regulatory compliance, and all safety and security requirements is the responsibility of the Buyer. These resources are subject to change without notice.

Electrical Characteristics

Maximum Ratings (@ $T_A = 25^\circ\text{C}$, Unless otherwise specified)

Parameters	Value	Unit
V_{RGS} Reverse Gate Source and Gate Drain Voltage	-40	V
I_{FG} Continuous Forward Gate Current	50	mA
P_D Continuous Device Power Dissipation	300	mW
P Power Derating	1.7	mW/ $^\circ\text{C}$
T_J Operating Junction Temperature	-55 to 125	$^\circ\text{C}$
T_{STG} Storage Temperature	-65 to 200	$^\circ\text{C}$

Static Characteristics (@ $T_A = 25^\circ\text{C}$, Unless otherwise specified)

Parameters	Conditions	2N4867/A		2N4868/A		2N4869/A		Unit
		Min	Max	Min	Max	Min	Max	
$V_{(BR)GSS}$ Gate to Source Breakdown Voltage	$V_{DS} = 0\text{V}, I_G = -1\mu\text{A}$	-40		-40		-40		V
I_{GSS} Gate to Source Reverse Current	$V_{GS} = -30\text{V}, V_{DS} = 0\text{V}, T_A = 25^\circ\text{C}$		-0.25		-0.25		-0.25	nA
	$V_{GS} = -30\text{V}, V_{DS} = 0\text{V}, T_A = 150^\circ\text{C}$		-0.25		-0.25		-0.25	μA
$V_{GS(OFF)}$ Gate to Source Cutoff Voltage	$V_{DS} = 20\text{V}, I_D = 1\mu\text{A}$	-0.7	-2	-1	-3	-1.8	-5	V
I_{DSS} Drain to Source Saturation Current	$V_{DS} = 20\text{V}, V_{GS} = 0\text{V}$ (Pulsed)	0.4	1.2	1	3	2.5	7.5	mA

Dynamic Characteristics (@ $T_A = 25^\circ\text{C}$, Unless otherwise specified)

Parameters	Conditions	2N4867/A		2N4868/A		2N4869/A		Unit
		Min	Max	Min	Max	Min	Max	
G_{FS} Forward Transconductance	$V_{DS} = 20\text{V}, V_{GS} = 0\text{V}, f = 1\text{kHz}$	700	2000	1000	3000	1300	4000	μS
G_{OS} Output Conductance	$V_{DS} = 20\text{V}, V_{GS} = 0\text{V}, f = 1\text{kHz}$		1.5		4		10	μS
C_{iss} Input Capacitance	$V_{DS} = 20\text{V}, V_{GS} = 0\text{V}, f = 1\text{MHz}$		25		25		25	pF
C_{rss} Reverse Transfer Capacitance	$V_{DS} = 20\text{V}, V_{GS} = 0\text{V}, f = 1\text{MHz}$		5		5		5	pF
e_n Equivalent Circuit Input Noise Voltage	$V_{DS} = 10\text{V}, V_{GS} = 0\text{V}, f = 10\text{Hz}$		20		20		20	nV/ $\sqrt{\text{Hz}}$
	$V_{DS} = 10\text{V}, V_{GS} = 0\text{V}, f = 1\text{kHz}$		10		10		10	
NF Noise Figure	$V_{DS} = 10\text{V}, V_{GS} = 0\text{V}, f = 1\text{kHz}$ $R_G = 20\text{ k}\Omega, A$ variant $R_G = 5\text{ k}\Omega$		1		1		1	dB

SOT23 (TO-236AB) Mechanical and Layout Data

Package Outline Data



1. All linear dimensions are in millimeters.
2. Package weight approximately 0.12 grams
3. Molded plastic case UL 94V-0 rated
4. For Tape and Reel specifications refer to InterFET CTC-021 Tape and Reel Specification, Document number: IF39002
5. Bulk product is shipped in standard ESD shipping material
6. Refer to JEDEC standards for additional information.

Suggested Pad Layout



1. All linear dimensions are in millimeters.
2. The suggested land pattern dimensions have been provided for reference only. A more robust pattern may be desired for wave soldering.

TO-72 Mechanical and Layout Data

Package Outline Data

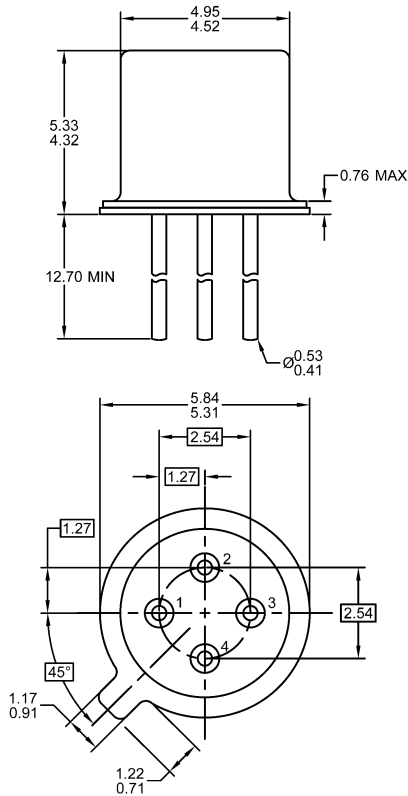

1. All linear dimensions are in millimeters.
2. Four leaded device. Not all leads are shown in drawing views.
3. Package weight approximately 0.31 grams
4. Bulk product is shipped in standard ESD shipping material
5. Refer to JEDEC standards for additional information.

Suggested Through-Hole Layout



1. All linear dimensions are in millimeters.
2. The suggested land pattern dimensions have been provided as a straight lead reference only. A more robust pattern may be desired for wave soldering and/or bent lead configurations.