

PNP - 2N6040, 2N6042, NPN - 2N6043, 2N6045



ON Semiconductor®

www.onsemi.com

Plastic Medium-Power Complementary Silicon Transistors

Plastic medium-power complementary silicon transistors are designed for general-purpose amplifier and low-speed switching applications.

Features

- High DC Current Gain – $h_{FE} = 2500$ (Typ) @ $I_C = 4.0$ Adc
- Collector–Emitter Sustaining Voltage – @ 100 mAdc –
 $V_{CE(sus)} = 60$ Vdc (Min) – 2N6040, 2N6043
 $= 100$ Vdc (Min) – 2N6042, 2N6045
- Low Collector–Emitter Saturation Voltage –
 $V_{CE(sat)} = 2.0$ Vdc (Max) @ $I_C = 4.0$ Adc – 2N6043,44
 $= 2.0$ Vdc (Max) @ $I_C = 3.0$ Adc – 2N6042, 2N6045
- Monolithic Construction with Built–In Base–Emitter Shunt Resistors
- Epoxy Meets UL 94 V–0 @ 0.125 in
- ESD Ratings: Human Body Model, 3B > 8000 V
Machine Model, C > 400 V
- These Devices are Pb–Free and are RoHS Compliant*

MAXIMUM RATINGS (Note 1)

Rating	Symbol	Value	Unit
Collector–Emitter Voltage	2N6040 2N6043 2N6042 2N6045	V_{CEO} 60 100	Vdc
Collector–Base Voltage	2N6040 2N6043 2N6042 2N6045	V_{CB} 60 100	Vdc
Emitter–Base Voltage		V_{EB} 5.0	Vdc
Collector Current	Continuous Peak	I_C 8.0 16	A dc
Base Current		I_B 120	mAdc
Total Power Dissipation @ $T_C = 25^\circ\text{C}$ Derate above 25°C		P_D 75 0.60	W W/ $^\circ\text{C}$
Operating and Storage Junction Temperature Range	T_J, T_{stg}	–65 to +150	$^\circ\text{C}$

Stresses exceeding those listed in the Maximum Ratings table may damage the device. If any of these limits are exceeded, device functionality should not be assumed, damage may occur and reliability may be affected.

1. Indicates JEDEC Registered Data.

DARLINGTON, 8 AMPERES COMPLEMENTARY SILICON POWER TRANSISTORS 60 – 100 VOLTS, 75 WATTS

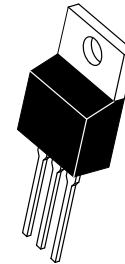

TO-220
CASE 221A
STYLE 1

MARKING DIAGRAM

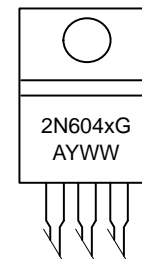

2N604x = Device Code
x = 0, 2, 3, or 5
A = Assembly Location
Y = Year
WW = Work Week
G = Pb–Free Package

ORDERING INFORMATION

See detailed ordering and shipping information in the package dimensions section on page 5 of this data sheet.

*For additional information on our Pb–Free strategy and soldering details, please download the ON Semiconductor Soldering and Mounting Techniques Reference Manual, SOLDERRM/D.

PNP – 2N6040, 2N6042, NPN – 2N6043, 2N6045

THERMAL CHARACTERISTICS

Characteristic	Symbol	Max	Unit
Thermal Resistance, Junction-to-Case	θ_{JC}	1.67	°C/W
Thermal Resistance, Junction-to-Ambient	θ_{JA}	57	°C/W

*ELECTRICAL CHARACTERISTICS ($T_C = 25^\circ\text{C}$ unless otherwise noted)

Characteristic	Symbol	Min	Max	Unit
OFF CHARACTERISTICS				
Collector-Emitter Sustaining Voltage ($I_C = 100\text{ mAdc}$, $I_B = 0$)	$V_{CEO(sus)}$	60 100	– –	Vdc
Collector Cutoff Current ($V_{CE} = 60\text{ Vdc}$, $I_B = 0$) ($V_{CE} = 100\text{ Vdc}$, $I_B = 0$)	I_{CEO}	– –	20 20	μA
Collector Cutoff Current ($V_{CE} = 60\text{ Vdc}$, $V_{BE(off)} = 1.5\text{ Vdc}$) ($V_{CE} = 100\text{ Vdc}$, $V_{BE(off)} = 1.5\text{ Vdc}$) ($V_{CE} = 60\text{ Vdc}$, $V_{BE(off)} = 1.5\text{ Vdc}$, $T_C = 150^\circ\text{C}$) ($V_{CE} = 80\text{ Vdc}$, $V_{BE(off)} = 1.5\text{ Vdc}$, $T_C = 150^\circ\text{C}$) ($V_{CE} = 100\text{ Vdc}$, $V_{BE(off)} = 1.5\text{ Vdc}$, $T_C = 150^\circ\text{C}$)	I_{CEX}	– – – – –	20 20 200 200 200	μA
Collector Cutoff Current ($V_{CB} = 60\text{ Vdc}$, $I_E = 0$) ($V_{CB} = 100\text{ Vdc}$, $I_E = 0$)	I_{CBO}	– –	20 20	μA
Emitter Cutoff Current ($V_{BE} = 5.0\text{ Vdc}$, $I_C = 0$)	I_{EBO}	–	2.0	mAdc

ON CHARACTERISTICS

DC Current Gain ($I_C = 4.0\text{ Adc}$, $V_{CE} = 4.0\text{ Vdc}$) ($I_C = 3.0\text{ Adc}$, $V_{CE} = 4.0\text{ Vdc}$) ($I_C = 8.0\text{ Adc}$, $V_{CE} = 4.0\text{ Vdc}$)	h_{FE}	1000 1000 100	20,000 20,000 –	–
Collector-Emitter Saturation Voltage ($I_C = 4.0\text{ Adc}$, $I_B = 16\text{ mAdc}$) ($I_C = 3.0\text{ Adc}$, $I_B = 12\text{ mAdc}$) ($I_C = 8.0\text{ Adc}$, $I_B = 80\text{ Adc}$)	$V_{CE(sat)}$	– – –	2.0 2.0 4.0	Vdc
Base-Emitter Saturation Voltage ($I_C = 8.0\text{ Adc}$, $I_B = 80\text{ mAdc}$)	$V_{BE(sat)}$	–	4.5	Vdc
Base-Emitter On Voltage ($I_C = 4.0\text{ Adc}$, $V_{CE} = 4.0\text{ Vdc}$)	$V_{BE(on)}$	–	2.8	Vdc

DYNAMIC CHARACTERISTICS

Small Signal Current Gain ($I_C = 3.0\text{ Adc}$, $V_{CE} = 4.0\text{ Vdc}$, $f = 1.0\text{ MHz}$)	$ h_{fe} $	4.0	–	
Output Capacitance ($V_{CB} = 10\text{ Vdc}$, $I_E = 0$, $f = 0.1\text{ MHz}$)	C_{ob}	– –	300 200	pF
Small-Signal Current Gain ($I_C = 3.0\text{ Adc}$, $V_{CE} = 4.0\text{ Vdc}$, $f = 1.0\text{ kHz}$)	h_{fe}	300	–	–

Product parametric performance is indicated in the Electrical Characteristics for the listed test conditions, unless otherwise noted. Product performance may not be indicated by the Electrical Characteristics if operated under different conditions.

*Indicates JEDEC Registered Data.

PNP – 2N6040, 2N6042, NPN – 2N6043, 2N6045

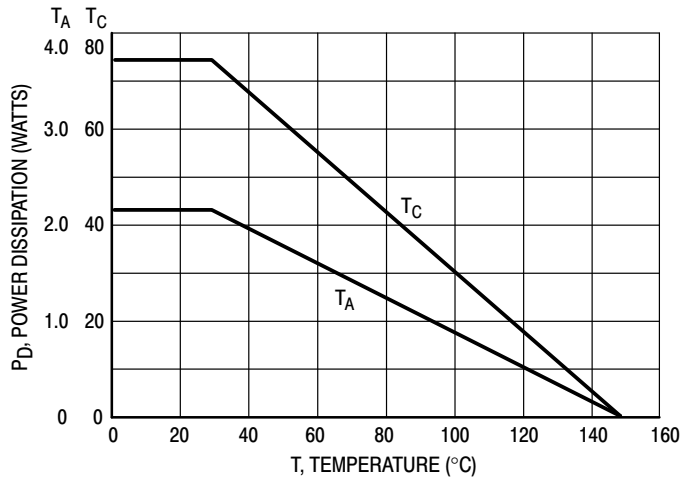

Figure 1. Power Derating

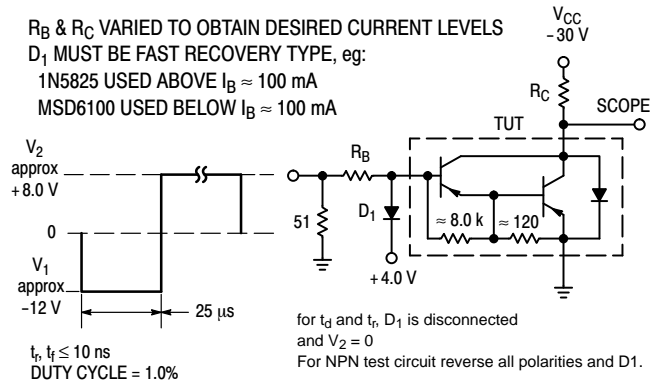

Figure 2. Switching Times Equivalent Circuit

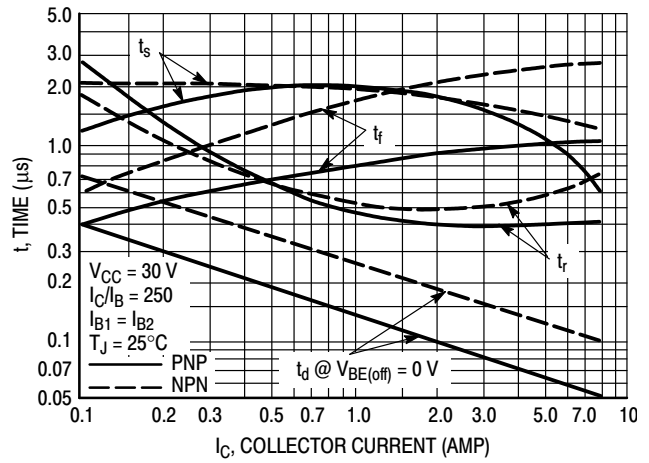

Figure 3. Switching Times

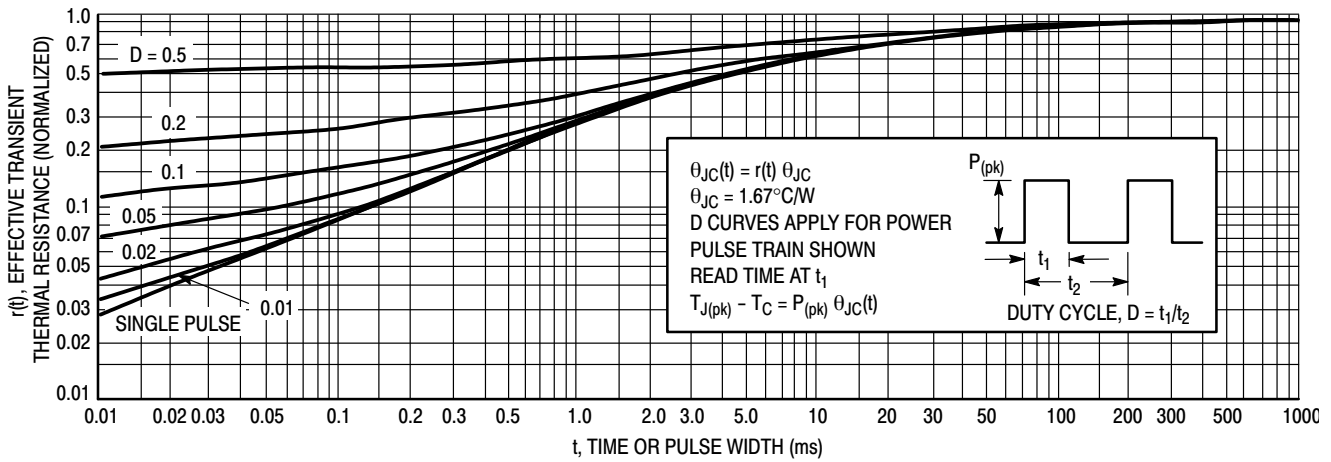

Figure 4. Thermal Response

PNP – 2N6040, 2N6042, NPN – 2N6043, 2N6045

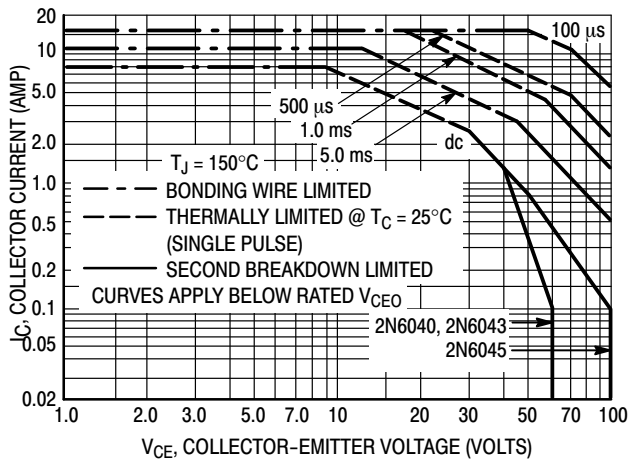

Figure 5. Active-Region Safe Operating Area

There are two limitations on the power handling ability of a transistor: average junction temperature and second breakdown. Safe operating area curves indicate $I_C - V_{CE}$ limits of the transistor that must be observed for reliable operation; i.e., the transistor must not be subjected to greater dissipation than the curves indicate.

The data of Figure 5 is based on $T_{J(pk)} = 150^\circ\text{C}$; T_C is variable depending on conditions. Second breakdown pulse limits are valid for duty cycles to 10% provided $T_{J(pk)} < 150^\circ\text{C}$. $T_{J(pk)}$ may be calculated from the data in Figure 4. At high case temperatures, thermal limitations will reduce the power that can be handled to values less than the limitations imposed by second breakdown.

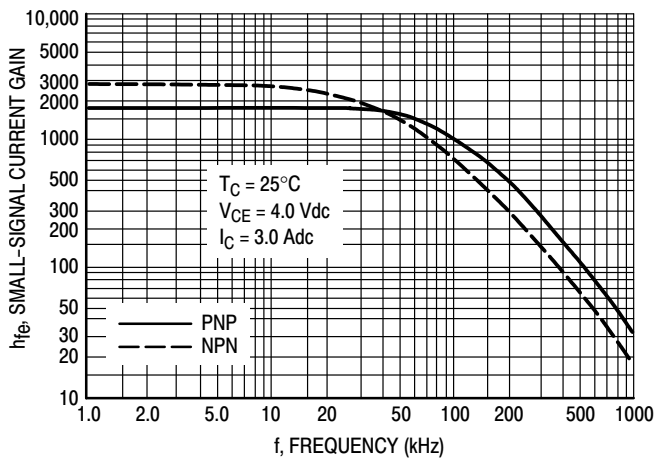

Figure 6. Small-Signal Current Gain

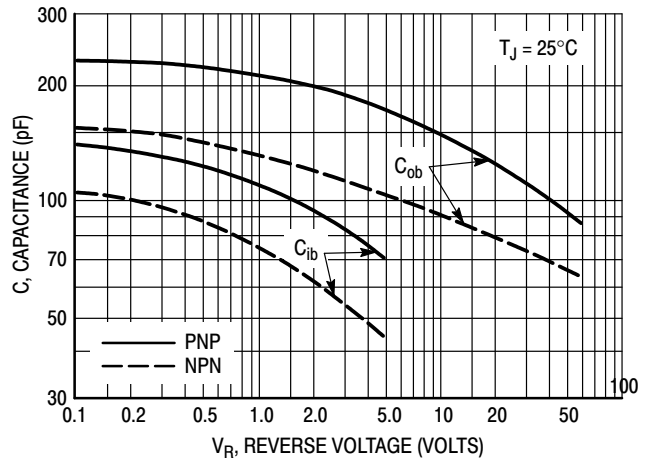

Figure 7. Capacitance

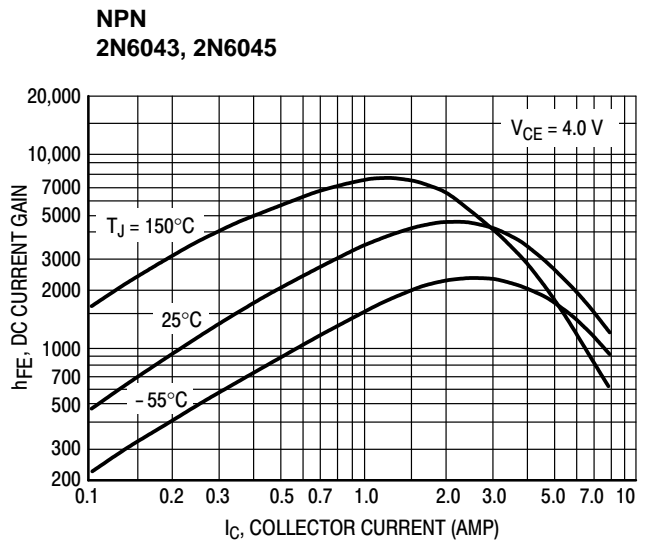
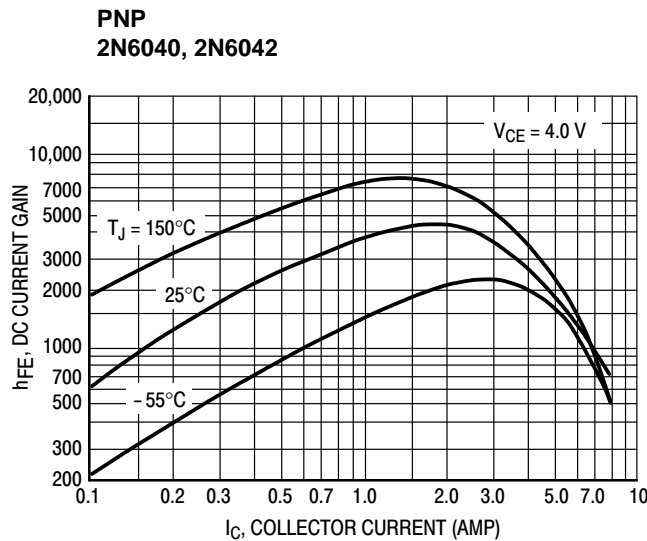

Figure 8. DC Current Gain

PNP – 2N6040, 2N6042, NPN – 2N6043, 2N6045

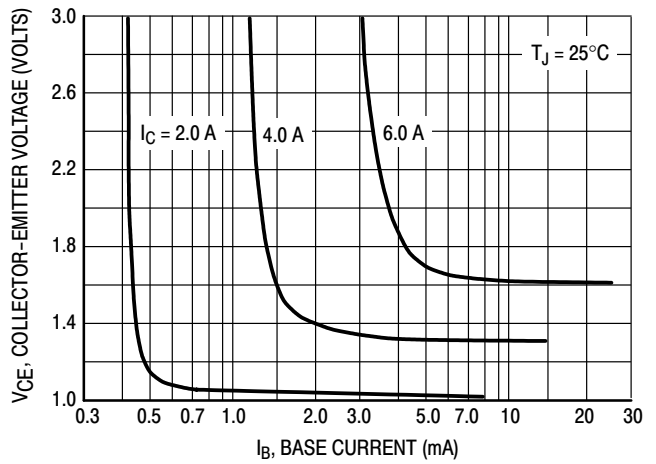
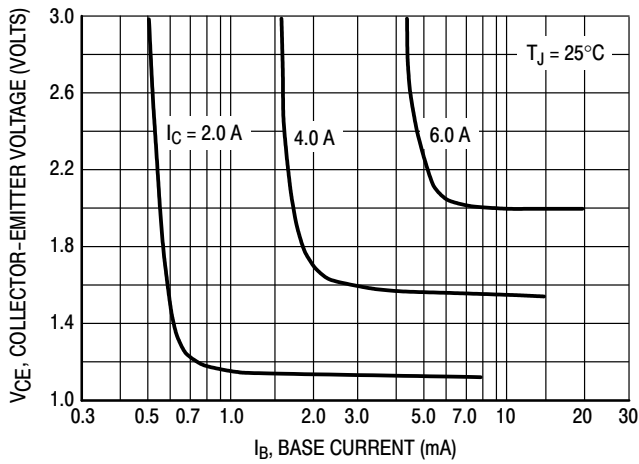

Figure 9. Collector Saturation Region

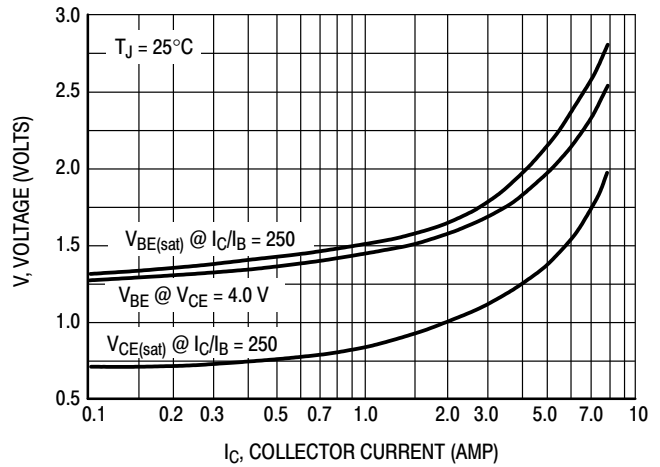
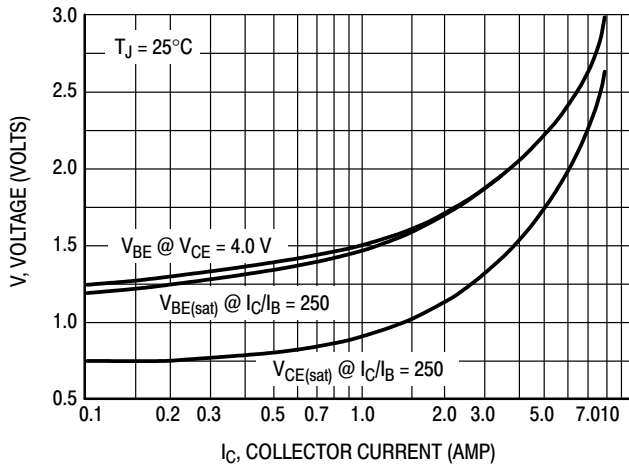

Figure 10. "On" Voltages

ORDERING INFORMATION

Device	Package	Shipping
2N6040G	TO-220 (Pb-Free)	50 Units / Rail
2N6042G	TO-220 (Pb-Free)	50 Units / Rail
2N6043G	TO-220 (Pb-Free)	50 Units / Rail
2N6045G	TO-220 (Pb-Free)	50 Units / Rail