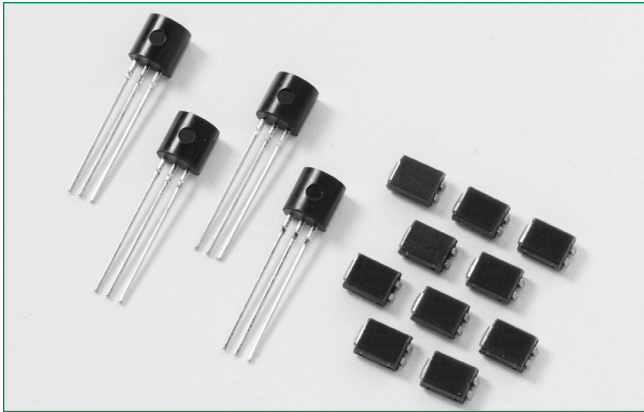


### EC103xx & SxSx Series

RoHS



#### Description

Excellent unidirectional switches for phase control applications such as heating and motor speed controls.

Sensitive gate SCRs are easily triggered with microAmps of current as furnished by sense coils, proximity switches, and microprocessors.

#### Features & Benefits

- RoHS compliant
- Glass – passivated junctions
- Voltage capability up to 600 V
- Surge capability up to 20 A

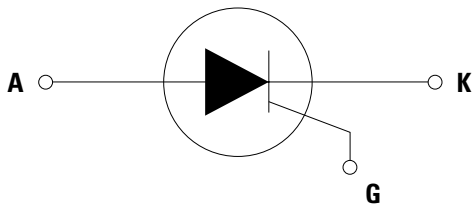
#### Main Features

Symbol	Value	Unit
$I_{T(RMS)}$	0.8	A
$V_{DRM}/V_{RRM}$	400 to 600	V
$I_{GT}$	12 to 500	$\mu$ A

#### Applications

Typical applications are capacitive discharge systems for strobe lights and gas engine ignition. Also controls for power tools, home/brown goods and white goods appliances.

#### Schematic Symbol



#### Additional Information



Datasheet



Resources



Samples

#### Absolute Maximum Ratings – Sensitive SCRs

Symbol	Parameter	Test Conditions	Value	Unit
$I_{T(RMS)}$	RMS on-state current	$T_c = 75^\circ\text{C}$	0.8	A
$I_{T(AV)}$	Average on-state current	$T_c = 75^\circ\text{C}$	0.51	A
$I_{TSM}$	Peak non-repetitive surge current	single half cycle; $f = 50\text{Hz}$ ; $T_J(\text{initial}) = 25^\circ\text{C}$	16	A
		single half cycle; $f = 60\text{Hz}$ ; $T_J(\text{initial}) = 25^\circ\text{C}$	20	
$I^2t$	$I^2t$ Value for fusing	$t_p = 8.3 \text{ ms}$	1.6	$\text{A}^2\text{s}$
$di/dt$	Critical rate of rise of on-state current	$f = 60 \text{ Hz}; T_J = 110^\circ\text{C}$	50	$\text{A}/\mu\text{s}$
$I_{GM}$	Peak gate current	$T_J = 110^\circ\text{C}$	1	A
$P_{G(AV)}$	Average gate power dissipation	$T_J = 110^\circ\text{C}$	0.1	W
$T_{stg}$	Storage temperature range		-40 to 150	$^\circ\text{C}$
$T_J$	Operating junction temperature range		-40 to 110	$^\circ\text{C}$

### Electrical Characteristics ( $T_J = 25^\circ\text{C}$ , unless otherwise specified)

Symbol	Test Conditions		Value				Unit
			SxS1 EC103X1	SxS2 EC103X2	SxS / 2N6565 EC103X	SxS3 EC103X3	
$I_{GT}$	$V_D = 6\text{V}; R_L = 100\ \Omega$	MAX.	12	50	200	500	$\mu\text{A}$
$V_{GT}$		MAX.	0.8				V
$V_{GRM}$	$I_{RG} = 10\ \mu\text{A}$	MIN.	5				V
dv/dt	$V_D = V_{DRM}; R_{GK} = 1\ \text{k}\Omega$	400V	20	25	30	40	V/ $\mu\text{s}$
		600V	10	10	15	20	
$V_{GD}$	$V_D = V_{DRM}; R_L = 3.3\ \text{k}\Omega; T_J = 110^\circ\text{C}$	MIN.	0.2	0.25			V
$I_H$	$I_T = 20\ \text{mA}$ (initial), $R_{GK} = 1\ \text{k}\Omega$	MAX.	5			8	mA
$t_q$	(1)	MAX.	60		50	45	$\mu\text{s}$
$t_{gt}$	$I_G = 2 \times I_{GT}; \text{PW} = 15\ \mu\text{s}; I_T = 1.6\ \text{A}$	TYP.	2	5	20	30	$\mu\text{s}$

1.  $I_T = 1\ \text{A}; t_q = 50\ \mu\text{s}; \text{dv/dt} = 5\ \text{V}/\mu\text{s}; \text{di/dt} = 5\ \text{A}/\mu\text{s}$

### Static Characteristics

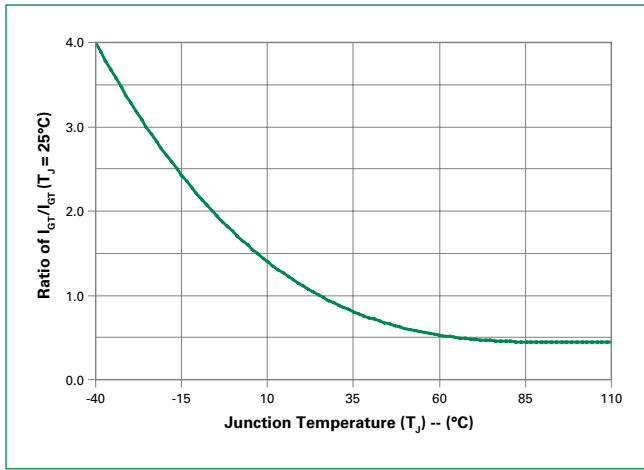
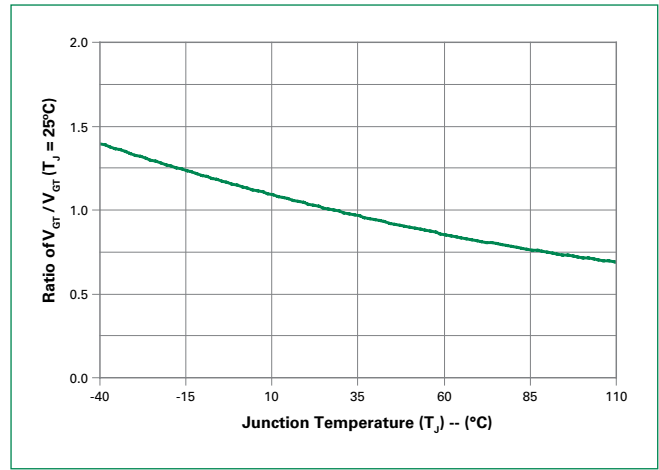
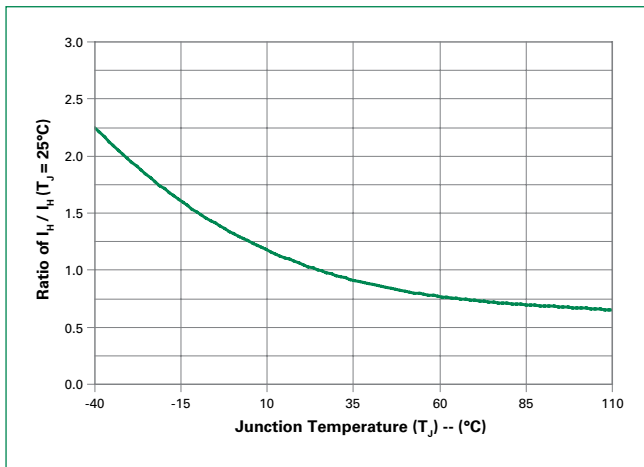
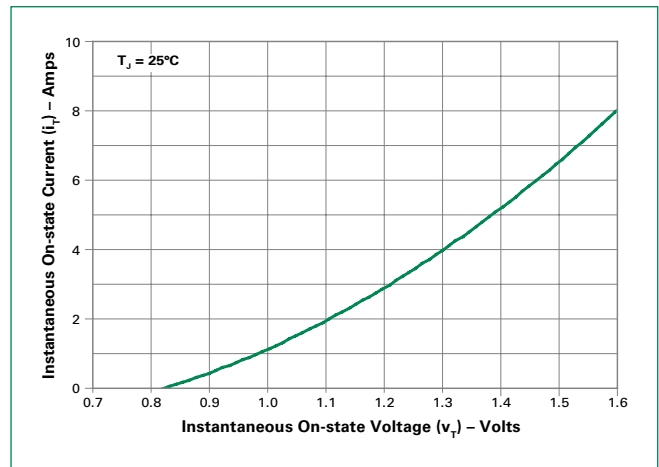
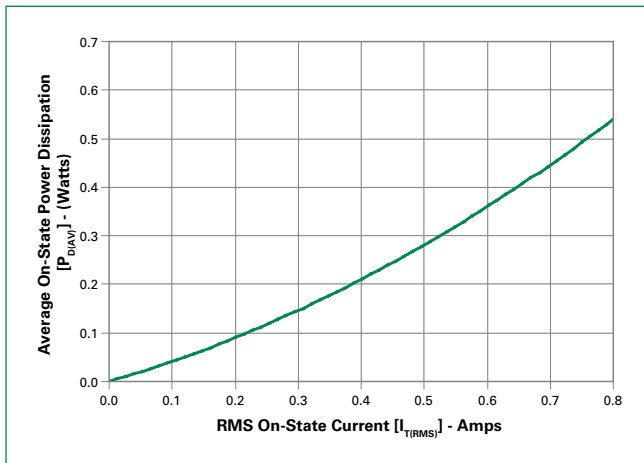
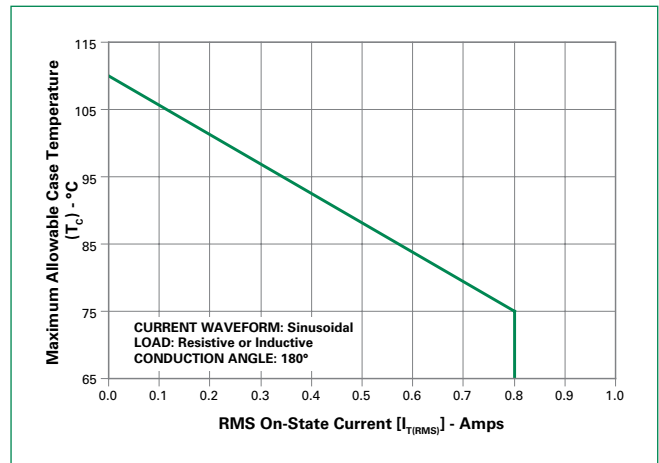
Symbol	Test Conditions		Value	Unit	
$V_{TM}$	$I_T = 1.2\ \text{A}; t_p = 380\ \mu\text{s}$		MAX.	1.4	V
$I_{DRM} / I_{RRM}$	$V_{DRM} = V_{RRM}$ $R_{GK} = 1\ \text{k}\Omega$	$T_J = 25^\circ\text{C}$	MAX.	1	$\mu\text{A}$
		$T_J = 100^\circ\text{C}$		50	
		$T_J = 110^\circ\text{C}$		100	

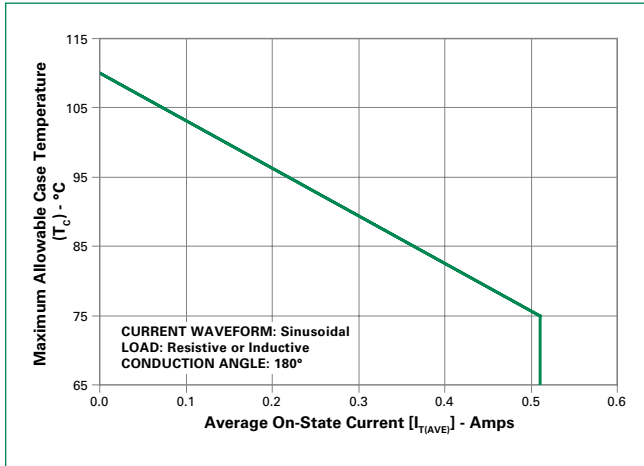
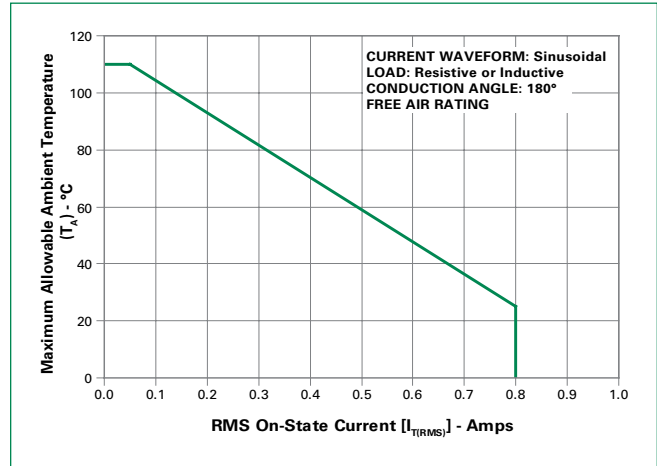
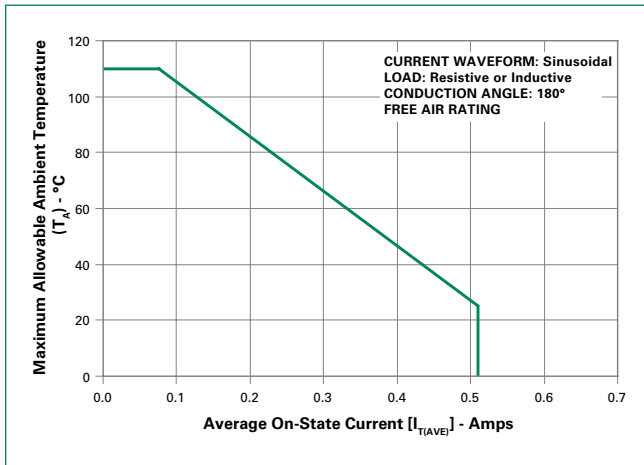
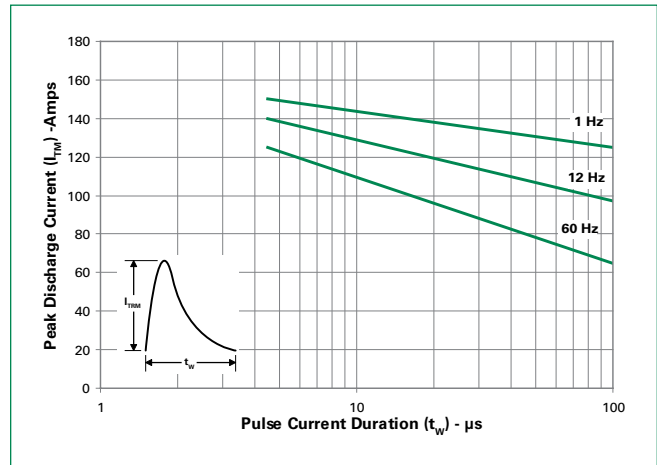
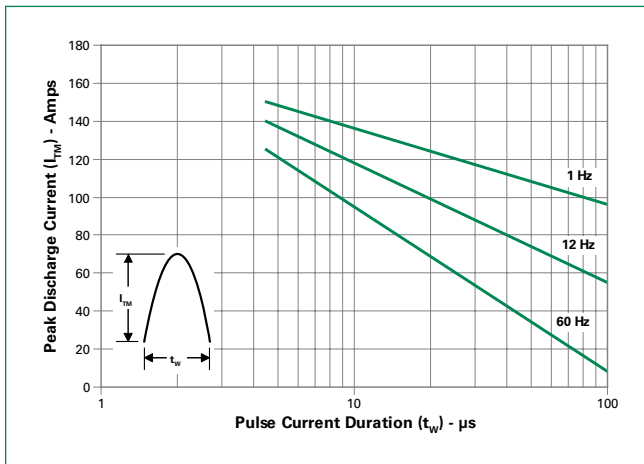
### Thermal Resistances

Symbol	Parameter		Value	Unit
$R_{\theta(JC)}$	Junction to case (AC)	EC103xy/2N6565	75	$^\circ\text{C}/\text{W}$
		SxSy	60*	
$R_{\theta(J-A)}$	Junction to ambient	EC103xy/2N6565	160	$^\circ\text{C}/\text{W}$

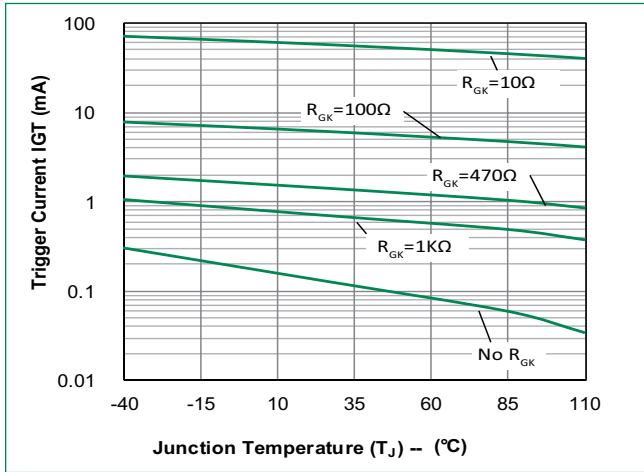
Notes: x = voltage, y = sensitivity

\* = Mounted on 1 cm<sup>2</sup> copper (two-ounce) foil surface

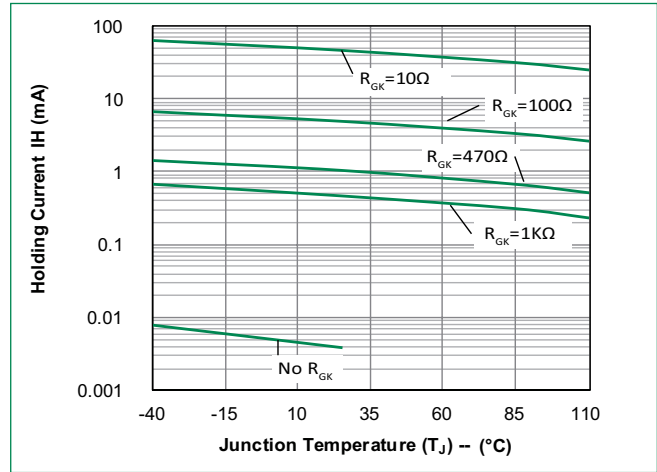
**Figure 1: Normalized DC Gate Trigger Current vs. Junction Temperature**

**Figure 2: Normalized DC Gate Trigger Voltage vs. Junction Temperature**

**Figure 3: Normalized DC Holding Current vs. Junction Temperature**

**Figure 4: On-State Current vs. On-State Voltage (Typical)**

**Figure 5: Power Dissipation (Typical) vs. RMS On-State Current**

**Figure 6: Maximum Allowable Case Temperature vs. RMS On-State Current**


**Figure 7: Maximum Allowable Case Temperature vs. Average On-State Current**

**Figure 8: Maximum Allowable Ambient Temperature vs. RMS On-State Current**

**Figure 9: Maximum Allowable Ambient Temperature vs. Average On-State Current**

**Figure 10: Peak Capacitor Discharge Current**

**Figure 11: Peak Repetitive Sinusoidal Pulse Current**


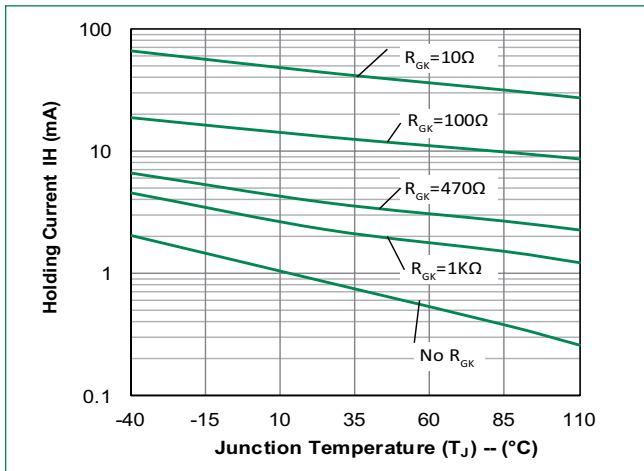
**Figure 12-1: Typical DC Gate Trigger Current with  $R_{GK}$  vs. Junction Temperature for EC103x**



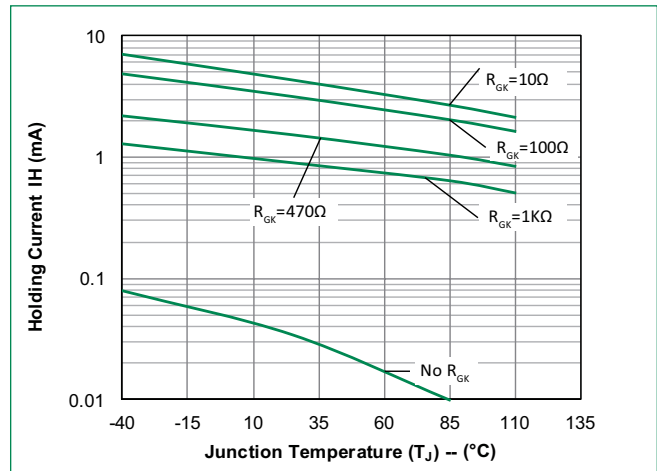
**Figure 12-2: Typical DC Gate Trigger Current with  $R_{GK}$  vs. Junction Temperature for EC103x1**



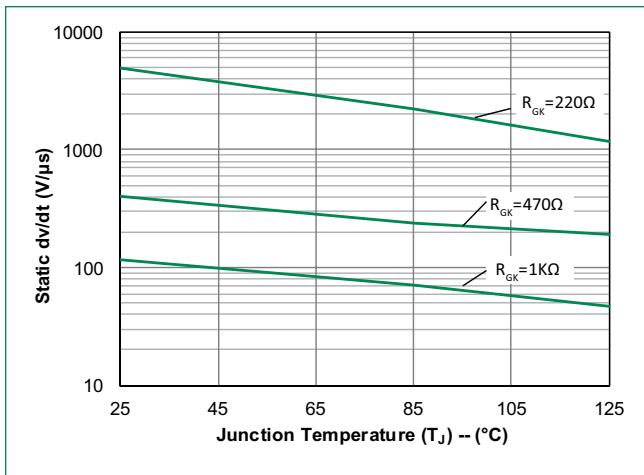
**Figure 13-1: Typical DC Holding Current with  $R_{GK}$  vs. Junction Temperature for EC103x**



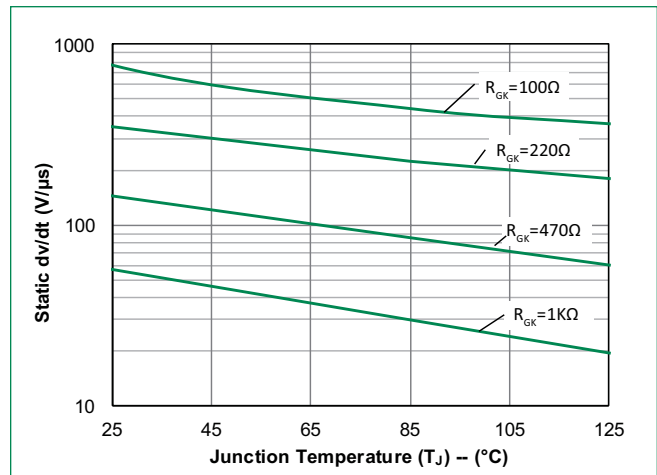
**Figure 13-2: Typical DC Holding Current with  $R_{GK}$  vs. Junction Temperature for EC103x1**

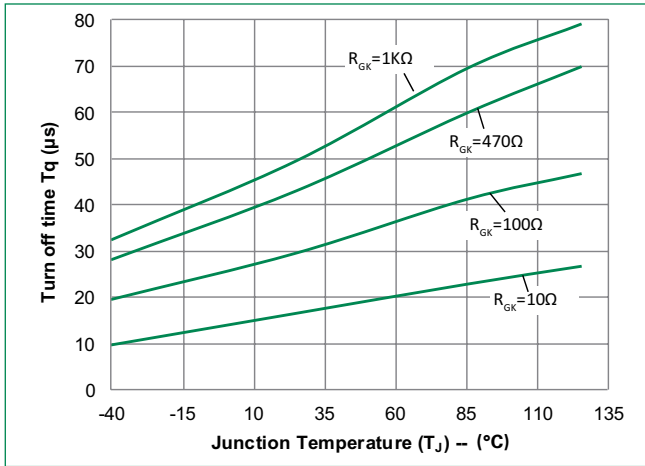
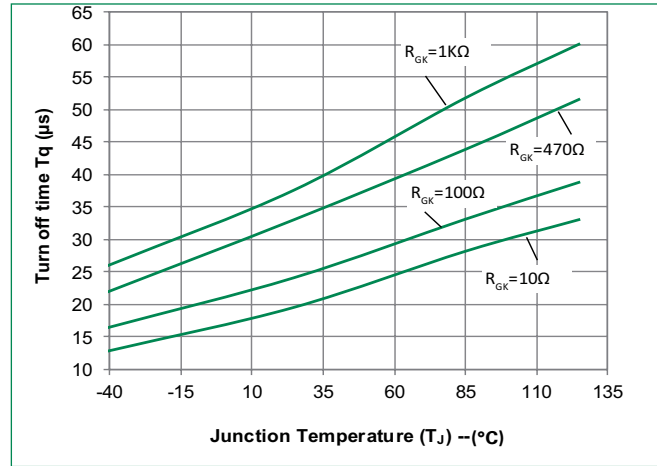
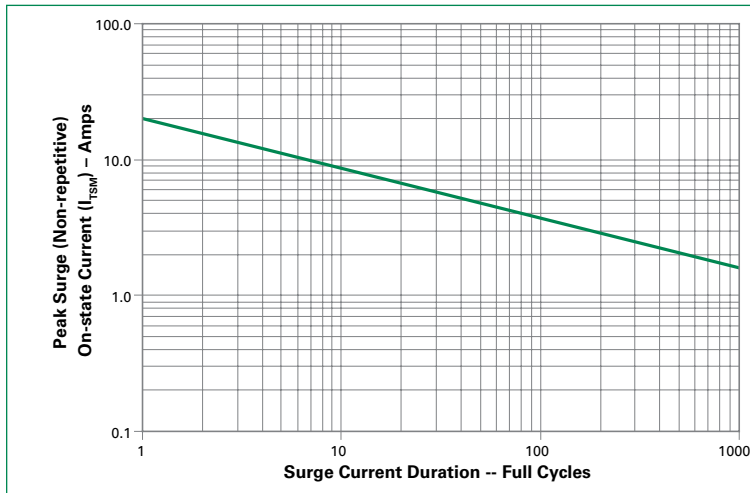


**Figure 14-1: Typical Static dv/dt with  $R_{GK}$  vs. Junction Temperature for EC103x**



**Figure 14-2: Typical Static dv/dt with  $R_{GK}$  vs. Junction Temperature for EC103x1**



**Figure 15-1: Typical turn off time with  $R_{GK}$  vs. Junction Temperature for EC103x**

**Figure 15-2: Typical turn off time with  $R_{GK}$  vs. Junction Temperature for EC103x1**

**Figure 16: Surge Peak On-State Current vs. Number of Cycles**


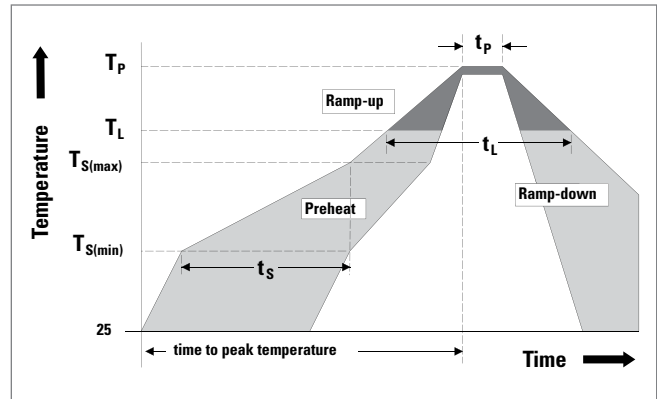
SUPPLY FREQUENCY: 60 Hz Sinusoidal  
 LOAD: Resistive  
 RMS On-State Current:  $I_{T(RMS)}$ : Maximum Rated Value at Specified Case Temperature

Notes:

1. Gate control may be lost during and immediately following surge current interval.
2. Overload may not be repeated until junction temperature has returned to steady-state rated value.

### Soldering Parameters

<b>Reflow Condition</b>		Pb – Free assembly
<b>Pre Heat</b>	- Temperature Min ( $T_{s(min)}$ )	150°C
	- Temperature Max ( $T_{s(max)}$ )	200°C
	- Time (min to max) ( $t_s$ )	60 – 180 secs
<b>Average ramp up rate (Liquidus Temp) (<math>T_L</math>) to peak</b>		5°C/second max
<b><math>T_{s(max)}</math> to <math>T_L</math> - Ramp-up Rate</b>		5°C/second max
<b>Reflow</b>	- Temperature ( $T_L$ ) (Liquidus)	217°C
	- Time ( $t_L$ )	60 – 150 seconds
<b>Peak Temperature (<math>T_p</math>)</b>		260 <sup>+0/-5</sup> °C
<b>Time within 5°C of actual peak Temperature (<math>t_p</math>)</b>		20 – 40 seconds
<b>Ramp-down Rate</b>		5°C/second max
<b>Time 25°C to peak Temperature (<math>T_p</math>)</b>		8 minutes Max.
<b>Do not exceed</b>		280°C



### Physical Specifications

<b>Terminal Finish</b>	100% Matte Tin-plated/Pb-free Solder Dipped
<b>Body Material</b>	UL Recognized compound meeting flammability rating V-0
<b>Lead Material</b>	Copper Alloy

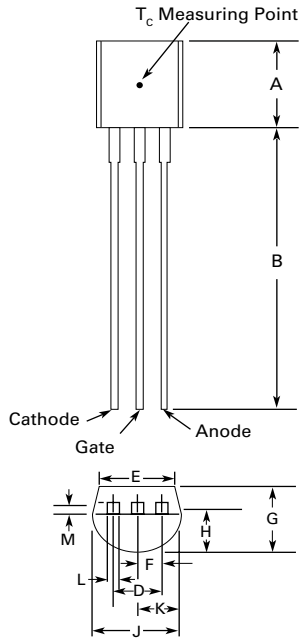
### Design Considerations

Careful selection of the correct component for the application's operating parameters and environment will go a long way toward extending the operating life of the Thyristor. Good design practice should limit the maximum continuous current through the main terminals to 75% of the component rating. Other ways to ensure long life for a power discrete semiconductor are proper heat sinking and selection of voltage ratings for worst case conditions. Overheating, overvoltage (including  $dv/dt$ ), and surge currents are the main killers of semiconductors. Correct mounting, soldering, and forming of the leads also help protect against component damage.

### Environmental Specifications

Test	Specifications and Conditions
<b>AC Blocking</b>	MIL-STD-750, M-1040, Cond A Applied Peak AC voltage @ 110°C for 1008 hours
<b>Temperature Cycling</b>	MIL-STD-750, M-1051, 100 cycles; -40°C to +150°C; 15-min dwell-time
<b>Temperature/Humidity</b>	EIA / JEDEC, JESD22-A101 1008 hours; 320V - DC; 85°C; 85% rel humidity
<b>High Temp Storage</b>	MIL-STD-750, M-1031, 1008 hours; 150°C
<b>Low-Temp Storage</b>	1008 hours; -40°C
<b>Resistance to Solder Heat</b>	MIL-STD-750 Method 2031
<b>Solderability</b>	ANSI/J-STD-002, category 3, Test A
<b>Lead Bend</b>	MIL-STD-750, M-2036 Cond E

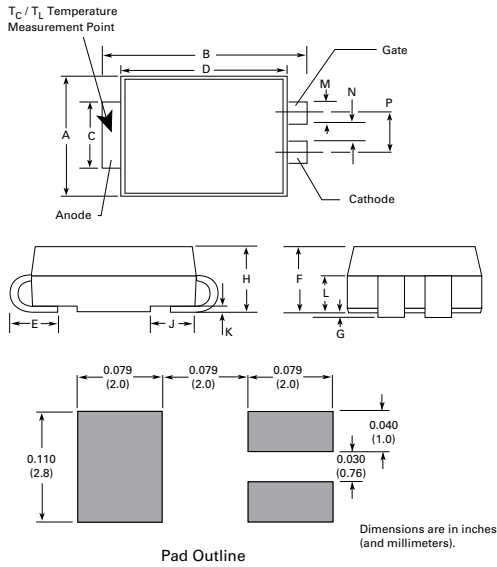
### Dimensions – TO-92 (E Package)



Dimension	Inches		Millimeters	
	Min	Max	Min	Max
A	0.176	0.196	4.47	4.98
B	0.500	-	12.70	-
D	0.095	0.105	2.41	2.67
E	0.150	-	3.81	-
F	0.046	0.054	1.16	1.37
G	0.135	0.145	3.43	3.68
H	0.088	0.096	2.23	2.44
J	0.176	0.186	4.47	4.73
K	0.088	0.096	2.23	2.44
L	0.013	0.019	0.33	0.48
M	0.013	0.017	0.33	0.43

All leads insulated from case. Case is electrically nonconductive.

### Dimensions – Compak (C Package)



Dimension	Inches		Millimeters	
	Min	Max	Min	Max
A	0.130	0.156	3.30	3.95
B	0.201	0.220	5.10	5.60
C	0.077	0.087	1.95	2.20
D	0.159	0.181	4.05	4.60
E	0.030	0.063	0.75	1.60
F	0.075	0.096	1.90	2.45
G	0.002	0.008	0.05	0.20
H	0.077	0.104	1.95	2.65
J	0.043	0.053	1.09	1.35
K	0.006	0.016	0.15	0.41
L	0.030	0.055	0.76	1.40
M	0.022	0.028	0.56	0.71
N	0.027	0.033	0.69	0.84
P	0.052	0.058	1.32	1.47



### Product Selector

Part Number	Voltage				Gate Sensitivity	Type	Package
	400V	600V	800V	1000V			
EC103 x 1	X	X			12 $\mu$ A	Sensitive SCR	TO-92
EC103 x 2	X	X			50 $\mu$ A	Sensitive SCR	TO-92
EC103 x	X / 2N6565	X			200 $\mu$ A	Sensitive SCR	TO-92
EC103 x 3	X	X			500 $\mu$ A	Sensitive SCR	TO-92
S x S1	X	X			12 $\mu$ A	Sensitive SCR	Compak
S x S2	X	X			50 $\mu$ A	Sensitive SCR	Compak
S x S	X	X			200 $\mu$ A	Sensitive SCR	Compak
S x S3	X	X			500 $\mu$ A	Sensitive SCR	Compak

Note: x = Voltage

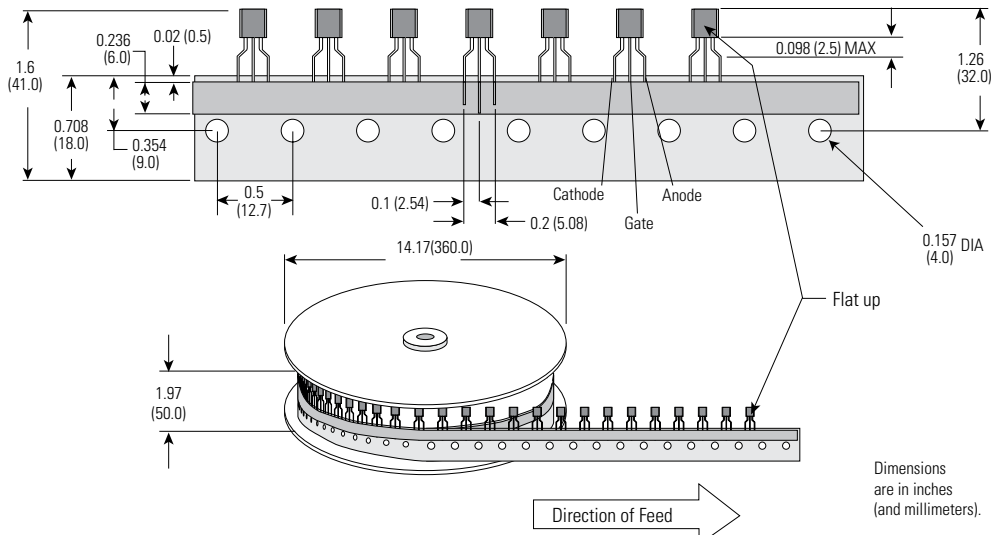
### Packing Options

Part Number	Marking	Weight	Packing Mode	Base Quantity
EC103xy / 2N6565	EC103xy / 2N6565	0.19 g	Bulk	2000
EC103xyRP	EC103xy	0.19 g	Reel Pack	2000
EC103xyAP	EC103xy	0.19 g	Ammo Pack	2000
SxSyRP	SxSy	0.08 g	Embossed Carrier	2500

Note: x = Voltage, y = sensitivity

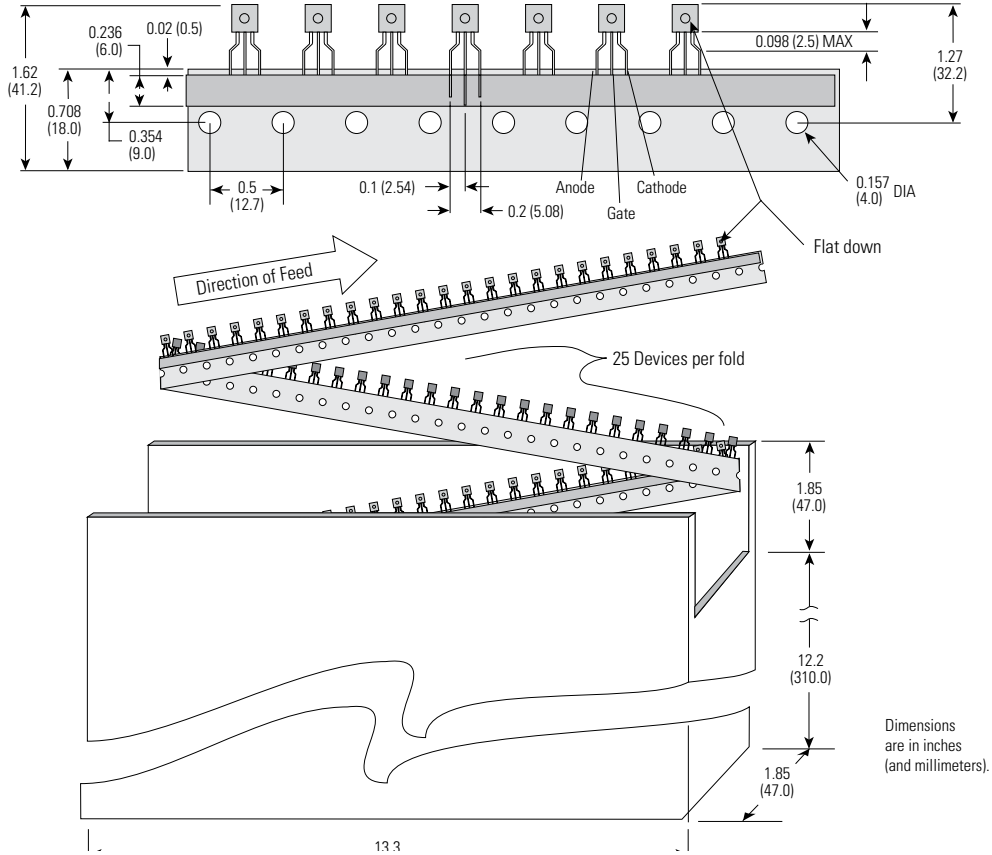
### TO-92 (3-lead) Reel Pack (RP) Radial Leaded Specifications

#### Meets all EIA-468-C Standards



### TO-92 (3-lead) Ammo Pack (AP) Radial Leaded Specifications

Meets all EIA-468-C Standards



### Compak Embossed Carrier Reel Pack (RP) Specifications

Meets all EIA-481-1 Standards

