

# DATA SHEET

**GAS DISCHARGE TUBES  
TELEPHONE INTERFACE**  
2R-8x6 series

RoHS compliant & free



Product specification— July 12, 2023 V.1



## Gas Discharge Tube (GDT) Data Sheet

### Features

- Provide ultra-fast response to surge voltage from slow-rising surge of 100V/s to rapid-rising surge of 1KV/μs
- Stable breakdown voltage
- High insulation resistance
- Low capacitance (≤1.5pF)
- High holdover voltage
- Large absorbing transient current capability
- Micro-Gap Design
- Size: 8.0mm\*6.0mm
- Storage and operating temperature: -40°C ~ +85°C
- Meets MSL level 1, per J-STD-020
- Safety certification: UL



### Applications

- Repeaters, Modems
- Telephone Interface, Line cards
- Data communication equipment
- Line test equipment

### Part Number Code



Ordering Code	Lead type	Packing
2RMXXXL-8/B 2RPXXXL-8/B	Lead	Box (Tray)
2RMXXXL-8/TR 2RPXXXL-8/TR	Lead	Tape & Reel
2RMXXXM-8 2RPXXXM-8	SMD	Tape & Reel

**Marking**

**B** : BrightKing Logo  
 2RM090-8 : Device Marking Code  
 XXXX : Internal Control Code

**Dimensions**

L Type		Dimension (mm)		
		Symbol	Spec.	Tolerance
		D	8.0	+0.3, -0.5
		T	6.0	+0.3, -0.5
		d	0.8	±0.1
		L	30.0	Max.

  

M Type		Dimension (mm)		
		Symbol	Spec.	Tolerance
		D	8.0	+0.3, -0.5
T	6.0	+0.3, -0.5		
B	0.5	±0.1		

**Electrical Characteristics**

Part Number	DC Spark-over Voltage	Maximum Impulse Spark-over Voltage	Nominal Impulse Discharge Current	Alternating Discharge Current	Impulse Life	Minimum Insulation Resistance		Maximum Capacitance	Device Marking Code	
						Test Voltage	(GΩ)			
						100V/s (V)	1000V/μs (V)	8/20μs 10times (KA)		50Hz, 1sec (A)
2RM075L-8	2RM075M-8	75±20%	600	10	10	500	25	1.0	1.5	2RM075-8
2RM090L-8	2RM090M-8	90±20%	600	10	10	500	50	1.0	1.5	2RM090-8
2RM120L-8	2RM120M-8	120±20%	600	10	10	500	50	1.0	1.5	2RM120-8
2RM145L-8	2RM145M-8	145±20%	700	10	10	500	100	1.0	1.5	2RM145-8
2RM150L-8	2RM150M-8	150±20%	700	10	10	500	100	1.0	1.5	2RM150-8
2RM230L-8	2RM230M-8	230±20%	700	10	10	500	100	1.0	1.5	2RM230-8
2RM250L-8	2RM250M-8	250±20%	800	10	10	500	100	1.0	1.5	2RM250-8
2RM300L-8	2RM300M-8	300±20%	900	10	10	500	100	1.0	1.5	2RM300-8
2RM350L-8	2RM350M-8	350±20%	900	10	10	500	100	1.0	1.5	2RM350-8
2RM400L-8	2RM400M-8	400±20%	1000	10	10	500	100	1.0	1.5	2RM400-8
2RM470L-8	2RM470M-8	470±20%	1100	10	10	500	250	1.0	1.5	2RM470-8
2RM600L-8	2RM600M-8	600±20%	1300	10	10	500	250	1.0	1.5	2RM600-8
2RM800L-8	2RM800M-8	800±20%	1500	10	10	500	250	1.0	1.5	2RM800-8
2RP075L-8	2RP075M-8	75±20%	600	20	20	500	25	1.0	1.5	2RP075-8
2RP090L-8	2RP090M-8	90±20%	600	20	20	500	50	1.0	1.5	2RP090-8
2RP120L-8	2RP120M-8	120±20%	600	20	20	500	50	1.0	1.5	2RP120-8
2RP145L-8	2RP145M-8	145±20%	700	20	20	500	100	1.0	1.5	2RP145-8
2RP150L-8	2RP150M-8	150±20%	700	20	20	500	100	1.0	1.5	2RP150-8
2RP230L-8	2RP230M-8	230±20%	700	20	20	500	100	1.0	1.5	2RP230-8
2RP250L-8	2RP250M-8	250±20%	800	20	20	500	100	1.0	1.5	2RP250-8
2RP300L-8	2RP300M-8	300±20%	900	20	20	500	100	1.0	1.5	2RP300-8
2RP350L-8	2RP350M-8	350±20%	900	20	20	500	100	1.0	1.5	2RP350-8
2RP400L-8	2RP400M-8	400±20%	1000	20	20	500	100	1.0	1.5	2RP400-8
2RP470L-8	2RP470M-8	470±20%	1100	20	20	500	250	1.0	1.5	2RP470-8
2RP600L-8	2RP600M-8	600±20%	1300	20	20	500	250	1.0	1.5	2RP600-8
2RP800L-8	2RP800M-8	800±20%	1500	20	20	500	250	1.0	1.5	2RP800-8

**Electrical Ratings**

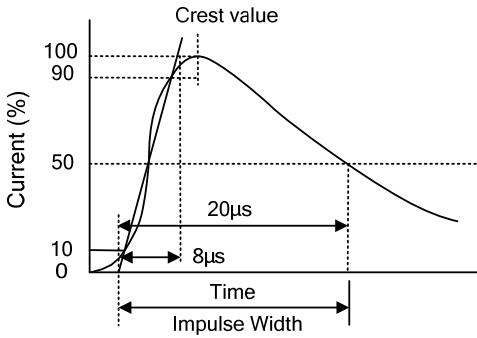
Items	Test Condition/Description	Requirement
DC Spark-over Voltage	The voltage is measured with voltage ramp $dv/dt=100V/s$ .	To meet the specified value
Maximum Impulse Spark-over Voltage	The maximum impulse spark-over voltage is measured with voltage ramp $dv/dt=1000V/\mu s$ .	
Impulse Discharge Current	<p>Maximum 8/20<math>\mu s</math> surge current that can be applied between two electrodes, 5 positive and 5 negative surges, with 3 minutes interval time.</p> 	
Alternating Discharge Current	Rated RMS value of AC current at 50Hz, 1 sec. for 10 times with interval time 3 min.	
Insulation Resistance	The resistance of gas tube shall be measured between two electrodes.	
Capacitance	The capacitance of gas tube shall be measured between two electrodes. Test frequency: 1MHz	

**Recommended Soldering Conditions**

Wave Soldering

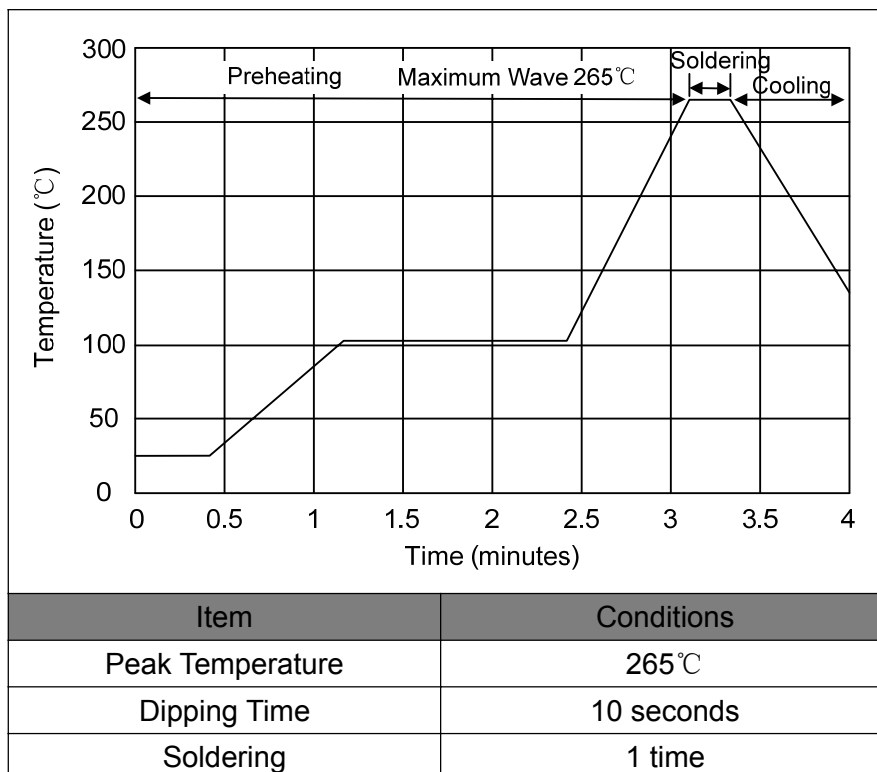

**Reflow Soldering**

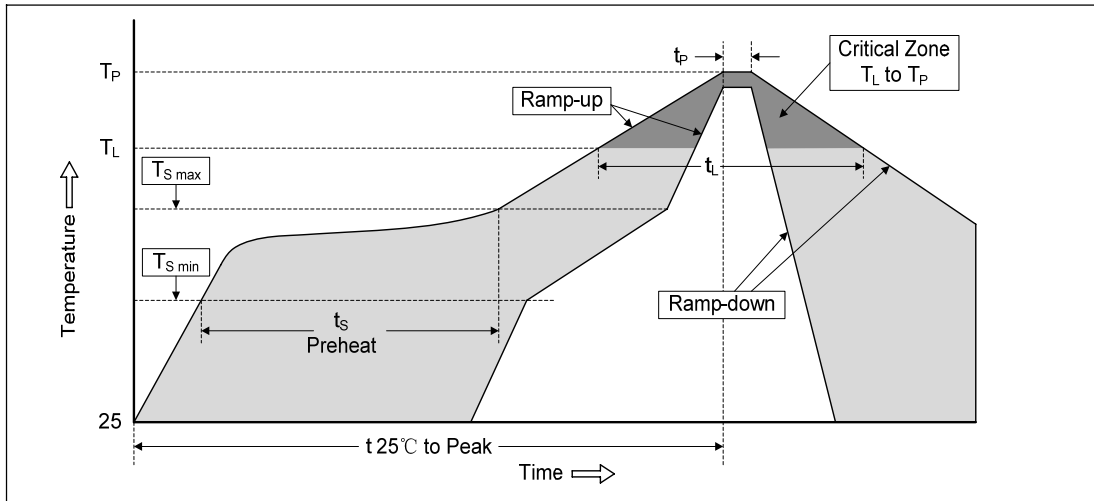

Profile Feature	Pb-Free Assembly
Average ramp-up rate (TL to TP)	3°C/second max.
Preheat -Temperature Min (TSmin) -Temperature Max (TSmax) -Time (min to max) (ts)	150°C 200°C 60-180 seconds
TSmax to TL -Ramp-up Rate	3°C/second max.
Time maintained above: -Temperature (TL) -Time (tL)	217°C 60-150 seconds
Peak Temperature (TP)	260°C
Time within 5°C of actual Peak Temperature (tp)	20-40 seconds
Ramp-down Rate	6°C/second max.
Time 25°C to Peak Temperature	8 minutes max.

**Packaging**

**Axial Packing (Box)**

**Skin packing**

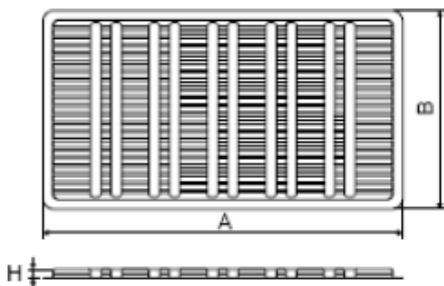

Symbol	Dimension (mm)	
	Spec.	Tolerance
A	267.0	±2.0
B	146.0	±2.0
H	8.5	±1.0

Quantity: 100pcs

**Inner box**

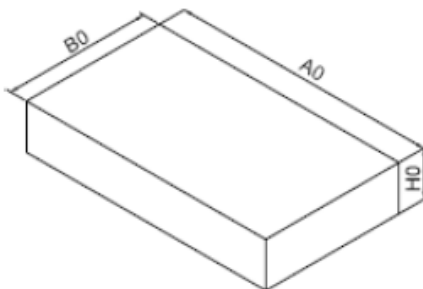

A0	270.0	±2.0
B0	150.0	±2.0
H0	50.0	±2.0

Quantity: 500pcs

Axial Packing (Tape & Reel)

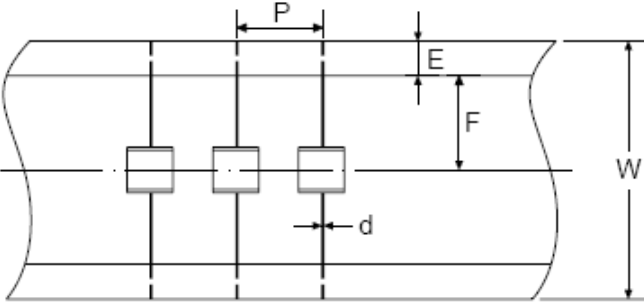
Tape	Symbol	Dimension (mm)	
		Spec.	Tolerance
	P	10.0	±0.5
	W	65.0	±1.0
	E	6.0	±0.5
	F	26.5	±0.5
	d	0.8	±0.1
	Reel		Quantity: 500pcs
Reel	Symbol	Dimension (mm)	
		Spec.	Tolerance
	A1	330.0	±2.0
	B1	70.0	±2.0
	C1	82.0	±2.0
	D	25.0	±0.5
t	2.0	±0.2	
Reel		Quantity: 500pcs	

SMD Packing (Tape & Reel)

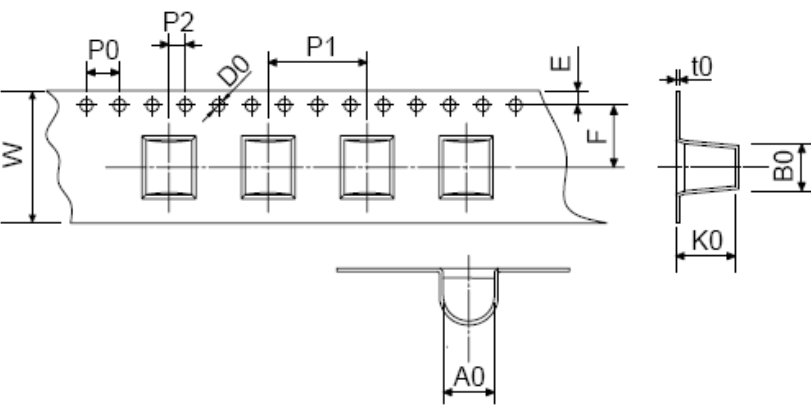
Tape	Symbol	Dimension (mm)		
		Spec.	Tolerance	
	W	16.00	±0.20	
	P0	4.00	±0.10	
	P1	12.00	±0.20	
	P2	2.00	±0.10	
	D0	1.55	±0.05	
	E	1.75	±0.10	
	F	7.50	±0.10	
	A0	8.20	±0.10	
	K0	8.50	±0.10	
	B0	7.50	±0.10	
	t0	0.50	±0.10	
	Reel		Quantity: 500pcs	
	Reel	Symbol	Dimension (mm)	
			Spec.	Tolerance
D		330.00	±2.00	
d		13.00	±0.50	
L	20.00	±2.00		
t	2.00	±0.20		
Reel		Quantity: 500pcs		