

Features

- Low Collector Saturation Voltage
- Excellent Current-to-Gain Characteristics
- Halogen Free."Green" Device^(Note 1)
- Moisture Sensitivity Level 1
- Epoxy Meets UL 94 V-0 Flammability Rating
- Lead Free Finish/RoHS Compliant ("P" Suffix Designates RoHS Compliant. See Ordering Information)

Maximum Ratings @ 25°C Unless Otherwise Specified

- Operating Junction Temperature Range: -55°C to +150°C
- Storage Temperature Range: -55°C to +150°C
- Thermal Resistance: 125°C/W Junction to Ambient

Parameter	Symbol	Rating	Unit
Collector-Base Voltage	V_{CBO}	-60	V
Collector-Emitter Voltage	V_{CEO}	-50	V
Emitter-Base Voltage	V_{EBO}	-5	V
Continuous Collector Current	I_C	-3	A
Power Dissipation	P_D	1	W

Note:

1.Halogen free "Green" products are defined as those which contain <900ppm bromine, <900ppm chlorine (<1500ppm total Br + Cl) and <1000ppm antimony compounds.

Internal Structure

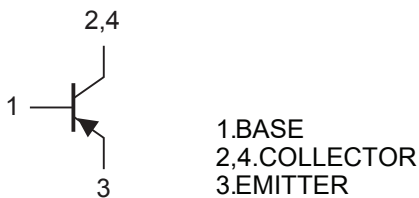

PNP Silicon Epitaxial Transistors

DPAK(TO-252)

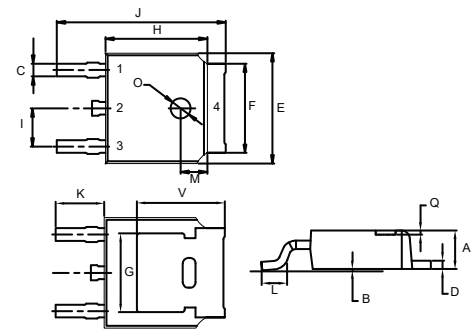

DIM	INCHES		MM		NOTE
	MIN	MAX	MIN	MAX	
A	0.087	0.094	2.20	2.40	
B	0.000	0.005	0.00	0.13	
C	0.026	0.034	0.66	0.86	
D	0.018	0.023	0.46	0.58	
E	0.256	0.264	6.50	6.70	
F	0.201	0.215	5.10	5.46	
G	0.190		4.83		TYP.
H	0.236	0.244	6.00	6.20	
I	0.086	0.094	2.18	2.39	
J	0.386	0.409	9.80	10.40	
K	0.114		2.90		TYP.
L	0.055	0.067	1.40	1.70	
M	0.063		1.60		TYP.
O	0.043	0.051	1.10	1.30	
Q	0.000	0.012	0.00	0.30	
V	0.211		5.35		TYP.

Electrical Characteristics @ $T_A=25^\circ\text{C}$ Unless Otherwise Specified

Parameter	Symbol	Min	Typ	Max	Units	Conditions
Collector-Base Breakdown Voltage	$V_{(BR)CBO}$	-60			V	$I_C=-50\mu\text{A}, I_E=0$
Collector-Emitter Breakdown Voltage	$V_{(BR)CEO}$	-50			V	$I_C=-1\text{mA}, I_B=0$
Emitter-Base Breakdown Voltage	$V_{(BR)EBO}$	-5			V	$I_E=-50\mu\text{A}, I_C=0$
Collector Cutoff Current	I_{CBO}			-1	μA	$V_{CB}=-40\text{V}, I_E=0$
Emitter Cutoff Current	I_{EBO}			-1	μA	$V_{EB}=-4\text{V}, I_C=0$
DC Current Gain	h_{FE}	82		390		$V_{CE}=-3\text{V}, I_C=-0.5\text{A}$
Collector-Emitter Saturation Voltage	$V_{CE(sat)}$			-1.0	V	$I_C=-2\text{A}, I_B=-200\text{mA}$
Transition Frequency	f_T		70		MHz	$V_{CE}=-5\text{V}, I_C=-500\text{mA}, f=30\text{MHz}$
Collector Output Capacitance	C_{ob}		50		pF	$V_{CB}=-10\text{V}, I_E=0, f=1\text{MHz}$

Classification of h_{FE}

Rank	P	Q	R
Range	82-180	120-270	180-390

Curve Characteristics

Fig. 1 - Static Characteristics

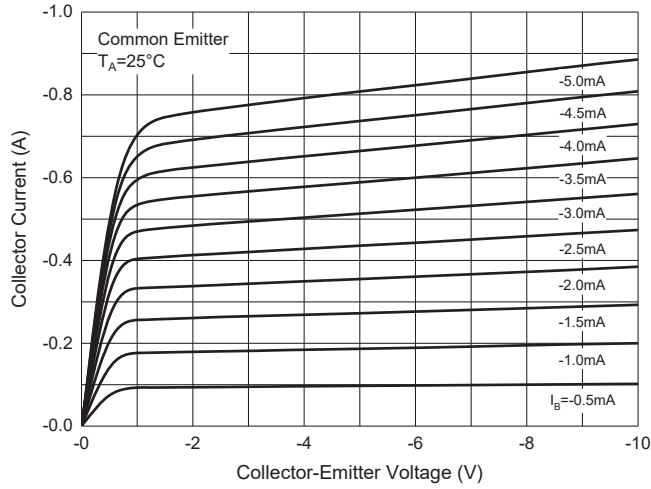

Fig. 2 - DC Current Gain Characteristics

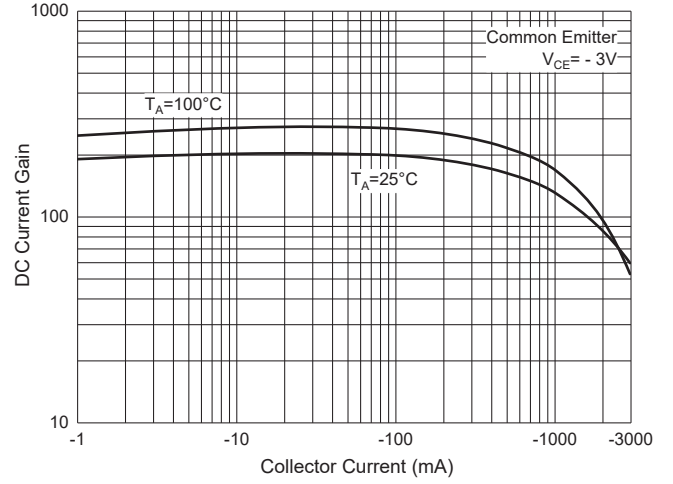

Fig. 3 - Collector-Emitter Saturation Voltage Characteristics

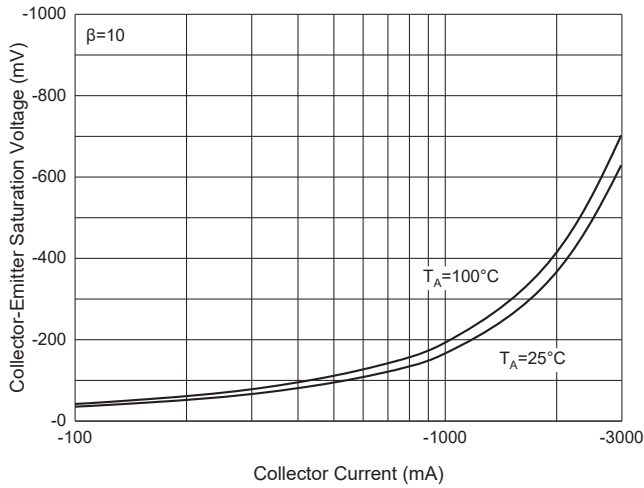

Fig. 4 - Base-Emitter Saturation Voltage Characteristics

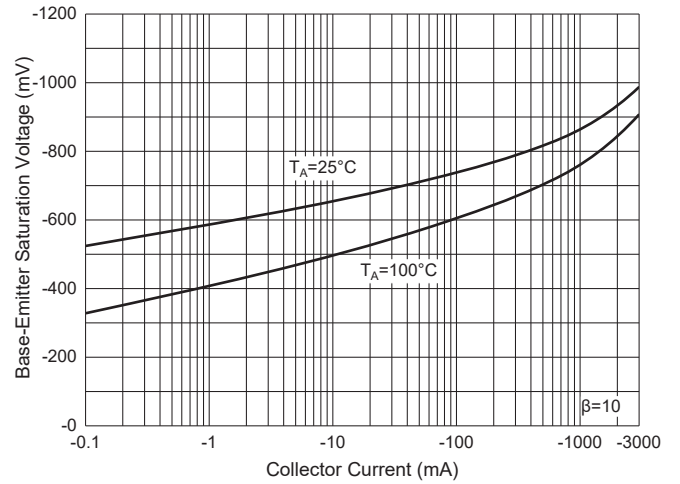

Fig. 5 - Base-Emitter Voltage Characteristics

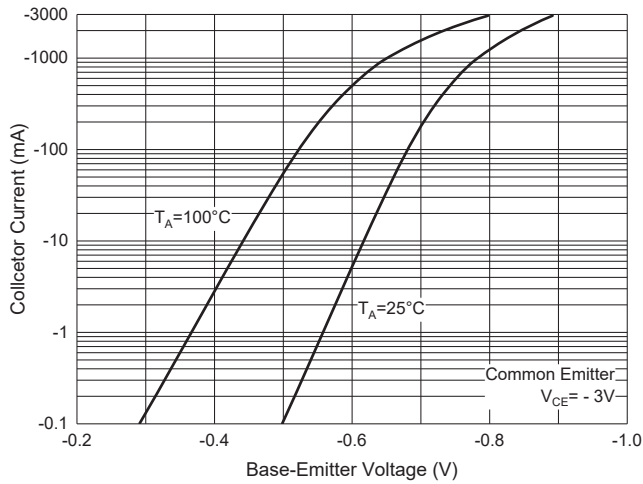

Fig. 6 - Collector Power Derating Curve

