

Features

- Halogen Free. "Green" Device (Note 1)
- Moisture Sensitivity Level 1
- Epoxy Meets UL 94 V-0 Flammability Rating
- Lead Free Finish/RoHS Compliant ("P" Suffix Designates RoHS Compliant. See Ordering Information)

Maximum Ratings @ 25°C Unless Otherwise Specified

- Operating Junction Temperature Range: -55°C to +150°C
- Storage Temperature Range: -55°C to +150°C
- Thermal Resistance: 250°C/W Junction to Ambient

Parameter	Symbol	Rating	Unit
Collector-Base Voltage	V_{CBO}	100	V
Collector-Emitter Voltage	V_{CEO}	80	V
Emitter-Base Voltage	V_{EBO}	5	V
Collector Current	DC	1	A
	Pulse ⁽²⁾	2	
Power Dissipation ⁽³⁾	DC	0.5	W
	Pulse ⁽²⁾	2	

Note: 1. Halogen free "Green" products are defined as those which contain <900ppm bromine, <900ppm chlorine (<1500ppm total Br + Cl) and <1000ppm antimony compounds.

2. Pulse Width=20ms, Duty Cycle=1/2.

3. Mounted on a 40x40x0.7mm Ceramic Board.

Marking: DF

Internal Structure

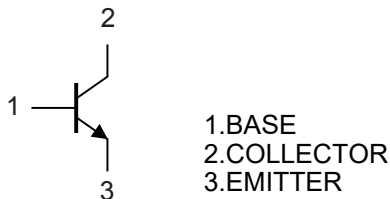

**NPN Silicon
Power Transistors**

SOT-89

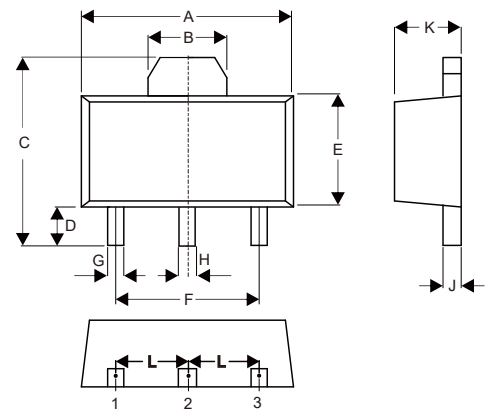

DIM	INCHES		MM		NOTE
	MIN	MAX	MIN	MAX	
A	0.169	0.185	4.30	4.70	
B	0.061		1.55		TYP.
C	0.154	0.171	3.91	4.35	
D	0.031	0.047	0.80	1.20	
E	0.089	0.104	2.25	2.65	
F	0.118		3.00		TYP.
G	0.013	0.020	0.33	0.52	
H	0.015	0.021	0.38	0.53	
J	0.014	0.017	0.35	0.44	
K	0.055	0.063	1.40	1.60	
L	0.059		1.50		TYP.

Suggested Solder Pad Layout

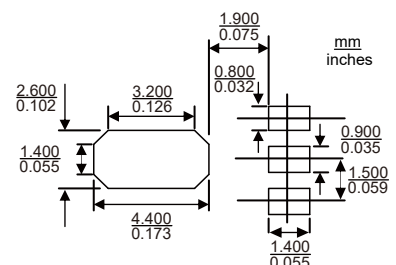

Electrical Characteristics @ $T_A=25^\circ\text{C}$ Unless Otherwise Specified

Parameter	Symbol	Min	Typ	Max	Units	Conditions
Collector-Base Breakdown Voltage	$V_{(BR)CBO}$	100			V	$I_C=50\mu\text{A}, I_E=0$
Collector-Emitter Breakdown Voltage	$V_{(BR)CEO}$	80			V	$I_C=1\text{mA}, I_B=0$
Emitter-Base Breakdown Voltage	$V_{(BR)EBO}$	5			V	$I_E=50\mu\text{A}, I_C=0$
Collector Cutoff Current	I_{CBO}			1	μA	$V_{CB}=80\text{V}, I_E=0$
Emitter Cutoff Current	I_{EBO}			1	μA	$V_{EB}=4\text{V}, I_C=0$
DC Current Gain	h_{FE}	82		390		$V_{CE}=3\text{V}, I_C=0.5\text{A}$
Collector-Emitter Saturation Voltage	$V_{CE(sat)}$		0.15	0.4	V	$I_C=500\text{mA}, I_B=20\text{mA}$
Transition Frequency	f_T		100		MHz	$V_{CE}=10\text{V}, I_C=50\text{mA}, f=100\text{MHz}$
Output Capacitance	C_{ob}		20		pF	$V_{CB}=10\text{V}, I_E=0, f=1\text{MHz}$

Classification of h_{FE}

Rank	P	Q	R
Range	82-180	120-270	180-390

Curve Characteristics

Fig. 1 - Static Characteristics

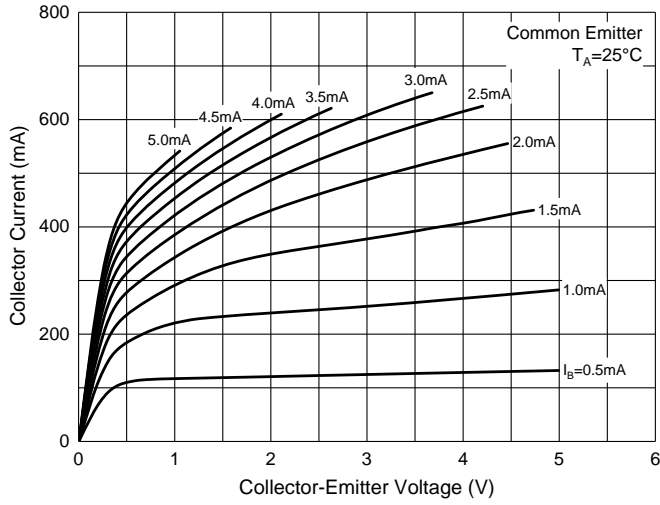

Fig. 2 - DC Current Gain Characteristics

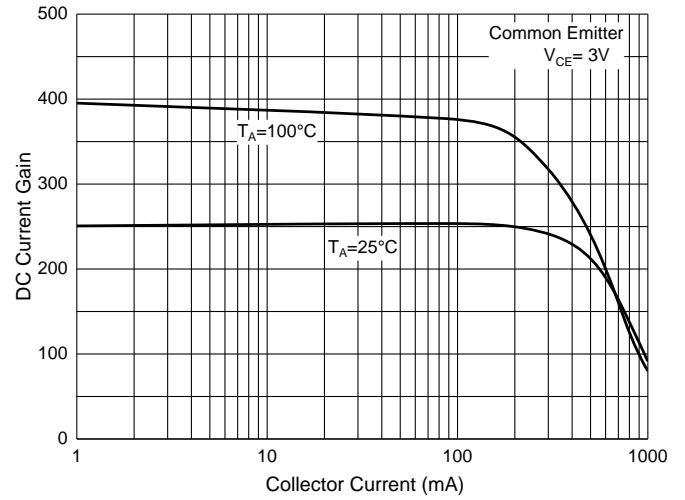

Fig. 3 - Base-Emitter Saturation Voltage Characteristics

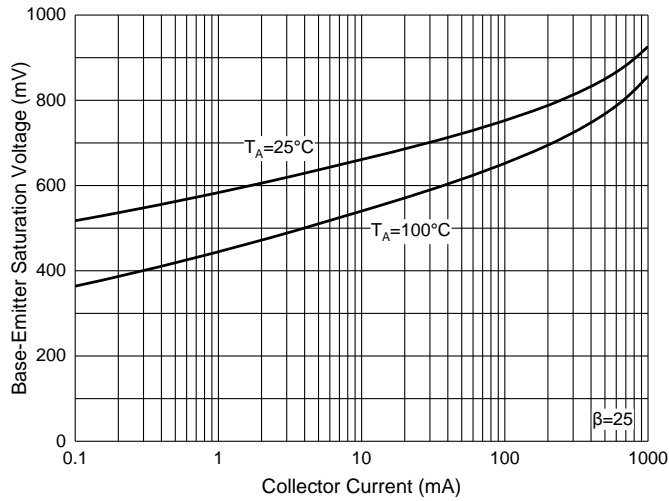

Fig. 4 - Collector-Emitter Saturation Voltage Characteristics

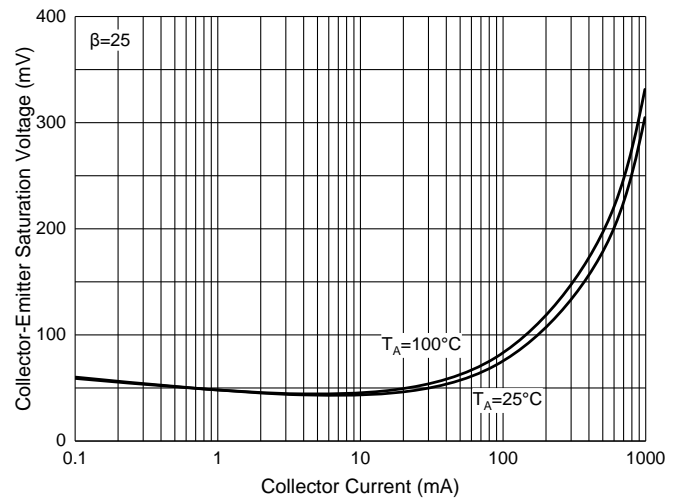

Fig. 5 - Collector Power Derating Curve

