

SURFACE MOUNT SCHOTTKY BARRIER RECTIFIER

VOLTAGE RANGE 20 to 60 Volts CURRENT 2.0 Amperes

FEATURES

- * Low power loss, high efficiency
- * Low leakage
- * Low forward voltage drop
- * High current capability
- * High speed switching
- * High surge capability
- * High reliability
- * Guard ring construction on dic

MECHANICAL DATA

- * Epoxy: Device has UL flammability classification 94V-O
- * Mounting position: Any
- * Weight: 0.018 gram (Approx.)
- * Flat lead frame
- * Anti-ESD

MAXIMUM RATINGS AND ELECTRICAL CHARACTERISTICS

Ratings at 25 °C ambient temperature unless otherwise specified.
Single phase, half wave, 60 Hz, resistive or inductive load.
For capacitive load, derate current by 20%.



SOD-123F

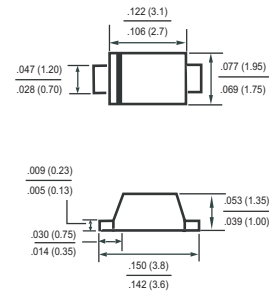

Dimensions in inches and (millimeters)

MAXIMUM RATINGS (@ TA=25 °C unless otherwise noted)

RATINGS	SYMBOL	2SS20	2SS30	2SS40	2SS50	2SS60	UNITS
Maximum Recurrent Peak Reverse Voltage	V _{RRM}	20	30	40	50	60	Volts
Maximum RMS Voltage	V _{RMS}	14	21	28	35	42	Volts
Maximum DC Blocking Voltage	V _{DC}	20	30	40	50	60	Volts
Maximum Average Forward Rectified Current @ T _A =75 °C	I _O	2.0					Amps
Peak Forward Surge Current 8.3 ms single half sine-wave superimposed on rated load (JEDEC method)	I _{FSM}	60					Amps
Typical Current Squared Time	i ² T	14.49					A ² S
Typical Thermal Resistance (Note 3)	R _{θJA}	110					°C/W
	R _{θJL}	3					
Operating Temperature Range	T _J	150					°C
Storage Temperature Range	T _{STG}	-55 to + 150					°C
Total Capacitance (Note 1)	C _T	75					pF

ELECTRICAL CHARACTERISTICS(@TA=25 °C unless otherwise noted)

CHARACTERISTICS	SYMBOL	2SS20	2SS30	2SS40	2SS50	2SS60	UNITS
Maximum Instantaneous Forward Voltage at 2.0A DC	V _F	0.55			0.70		Volts
Maximum Average Reverse Current at Rated DC Blocking Voltage	@ T _A = 25°C	0.2					mAmps
	@ T _A = 150°C	5					mAmps

- NOTES : 1. Measured at 1 MHz and applied reverse voltage of 4 Volts.
2. "ROHS compliant"
3. Thermal Resistance: Mounted on PCB.

RATING AND CHARACTERISTICS CURVES (2SS20 THRU 2SS60)

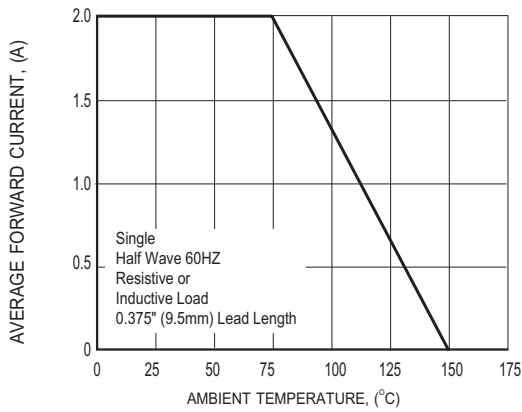

FIG.1 TYPICAL FORWARD CURRENT DERATING CURVE

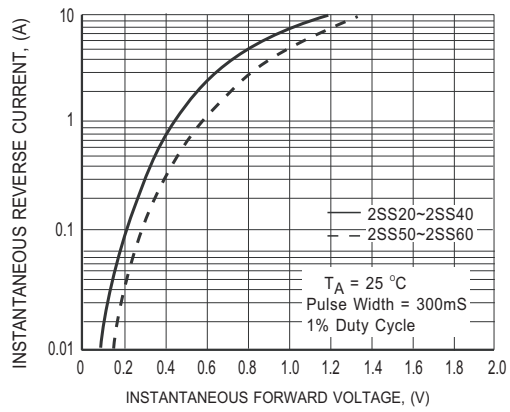

FIG.2 MAXIMUM INSTANTANEOUS FORWARD CHARACTERISTICS

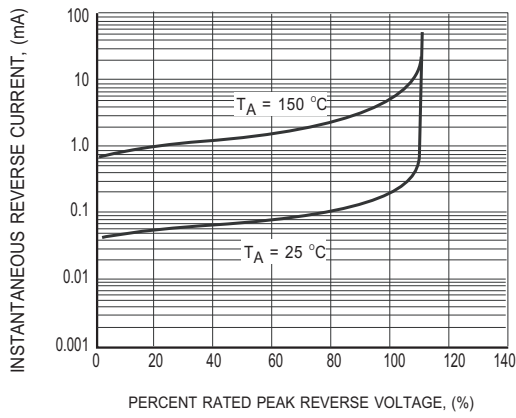

FIG.3 MAXIMUM REVERSE CHARACTERISTICS

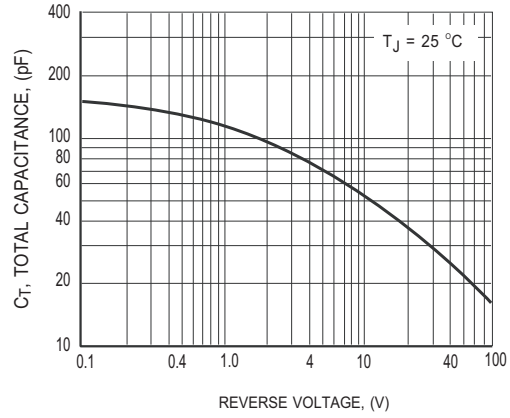

FIG.4 TYPICAL JUNCTION CAPACITANCE

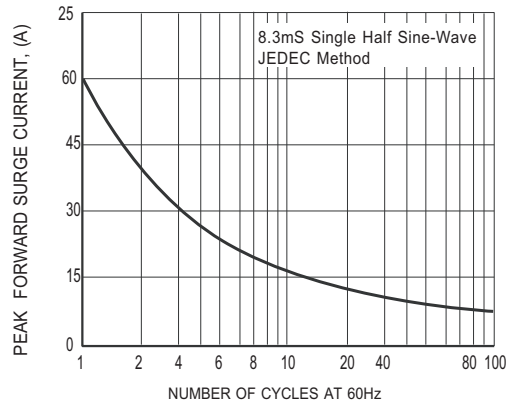
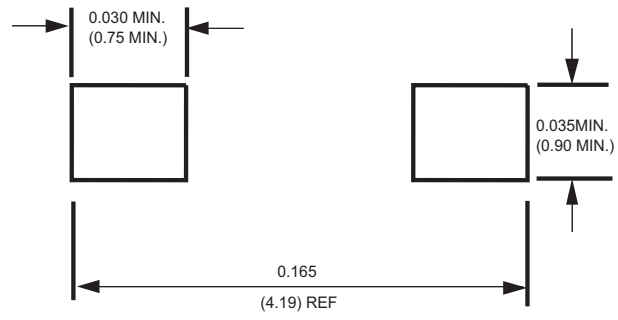

FIG.5 TYPICAL REVERSE CHARACTERISTICS

Mounting Pad Layout



Dimensions in inches and (millimeters)

Marking Description

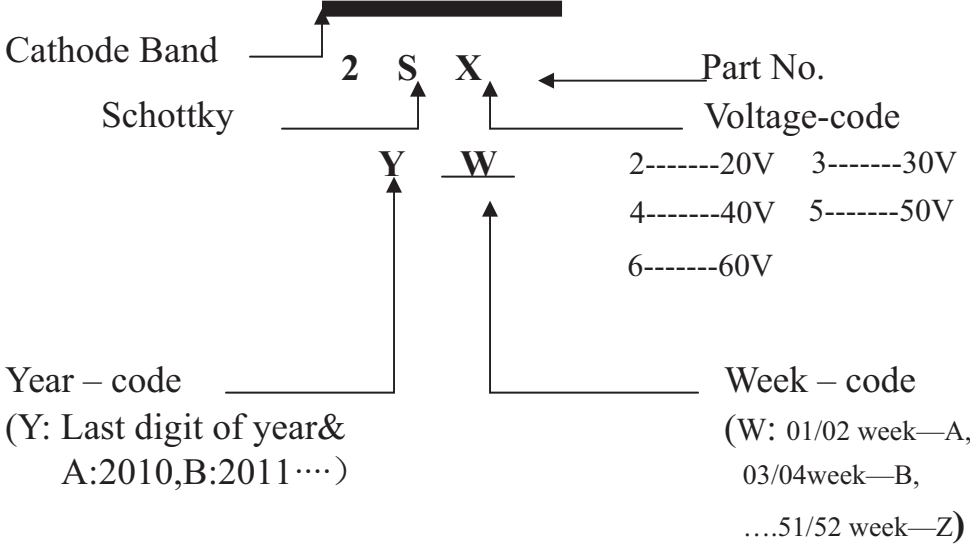

PACKAGING OF DIODE AND BRIDGE RECTIFIERS

REEL PACK

PACKAGE	PACKING CODE	EA PER REEL	EA PER INNER BOX	COMPONENT SPACE (mm)	TAPE SPACE (mm)	REEL DIA (mm)	CARTON SIZE (mm)	EA PER CARTON	GROSS WEIGHT(Kg)
SOD-123F/ SOD-123FL	-W	3,000	15,000	---	---	178	390*205*310	120,000	6.964