

IEC Appliance Inlet C14 with Line Switch 2-pole, Fuseholder 1- or 2-pole



See below:
[Approvals and Compliances](#)

Description

- Panel mount :
Screw-on from front side
- 3 Functions :
Appliance Inlet Protection class I , Line Switch 2-pole , Fuseholder for fuse-links 5 x 20 mm 1- or 2-pole
- Quick connect terminals 4.8 x 0.8 mm

Unique Selling Proposition

- V-Lock notch standard
- Meets the requirements of IEC 60335-1 for appliances in unattended use
- Includes the enhanced requirements of glow wire tests acc. to IEC 60695-2-11 or -12 &-13
- Minimal installation height

Characteristics

- Ultra-compact design. Ideal for low profile designs
- All single elements are already wired
- Ideal for application with high transient loads
- Suitable for use in equipment according to IEC/UL 62368-1

Other versions on request

- Fuse drawer 1-pole, plus spare fuse case
- Fuse drawer 2-pole, with shorting bar
- Other rocker marking
- Line switch 1-pole
- Protection class II, 70°C

References

- Alternative: version with line filter [DD12](#); [DD14](#)
- Alternative: version for snap-in mounting [KM](#)
- Alternative: version for PCB mounting [DD21](#)

Weblinks

[pdf data sheet](#), [html datasheet](#), [General Product Information](#), [Approvals](#), [Distributor-Stock-Check](#), [Accessories](#), [Detailed request for product](#)

Technical Data

Ratings IEC	10A / 250VAC; 50Hz	Appliance inlet/-outlet	C14 acc. to IEC 60320-1
Ratings UL/CSA	10A / 250VAC; 60Hz		UL 60320-1, CSA C22.2 no. 60320-1
Dielectric Strength	> 2.5 kVAC between L-N > 3 kVAC between L/N-PE (1 min/50Hz)		(for cold conditions) pin-temperature 70 °C, 10A, Protection Class I
Allowable Operation Temperature	-25 °C to 85 °C	Fuseholder	1-/2-pole, Shocksafe category PC2 acc. to IEC 60127-6, for fuse-links 5 x 20mm
IP-Protection	front side IP40 acc. to IEC 60529	Rated Power Acceptance @ Ta 23 °C	5 x 20: 2 W (1 pole)/ 1.6W (2-pole) per pole
Protection against electric shock	Suitable for appliances with protection class I acc. to IEC 61140	Power Acceptance @ Ta > 23°C	Admissible power acceptance at higher ambient temperature see derating curves
Terminal	Quick connect terminals 4.8 x 0.8 mm	Line Switch	Rocker switch 2-pole, non-illuminated or illuminated, acc. to IEC 61058-1
Panel Thickness S	Screw-on mounting: max 8mm Mounting screw torque max 0.5Nm		Technical Details
Material: Housing	Thermoplastic, black, UL 94V-0		

Approvals and Compliances



Detailed information on product approvals, code requirements, usage instructions and detailed test conditions can be looked up in [Details about Approvals](#)

SCHURTER products are designed for use in industrial environments. They have approvals from independent testing bodies according to national and international standards. Products with specific characteristics and requirements such as required in the automotive sector according to IATF 16949, medical technology according to ISO 13485 or in the aerospace industry can be offered exclusively with customer-specific, individual agreements by SCHURTER.

Approvals





The approval mark is used by the testing authorities to certify compliance with the safety requirements placed on electronic products.

Approval Reference Type: DD11

Approval Logo	Certificates	Certification Body	Description
	VDE Approvals	VDE	Certificate Number: 40046933
	UL Approvals	UL	UR File Number: E93617
	CCC Approvals	CCC	CCC Certificate Number: 2018180204007758



Product standards

Product standards that are referenced

Organization	Design	Standard	Description
	Designed according to	IEC 60320-1	Appliance couplers for household and similar general purposes
	Designed according to	IEC 60127-6	Miniature fuses. Part 6. Fuse-holders for miniature fuse-links
	Designed according to	IEC 61058-1	Switches for appliances. Part 1. General requirements
	Designed according to	UL 60320-1	Standard for Attachment Plugs and Receptacles
	Designed according to	CSA C22.2 no. 60320-1	General Use Receptacles, Attachment Plugs, and Similar Wiring Devices









Application standards

Application standards where the product can be used

Organization	Design	Standard	Description
	Suitable for applications acc.	IEC/UL 62368-1	Audio/video, information and communication technology equipment - Part 1: Safety requirements
	Suitable for applications acc.	IEC 60601-1	Medical electrical equipment - Part 1: General requirements for basic safety and essential performance
	Suitable for applications acc.	IEC 60335-1	Safety of electrical appliances for household and similar purposes. Meets the requirements for appliances in unattended use. This includes the enhanced requirements of glow wire tests acc. to IEC 60695-2-11 or -12 & -13.

Compliances

The product complies with following Guide Lines

Identification	Details	Initiator	Description
	CE declaration of conformity	SCHURTER AG	The CE marking declares that the product complies with the applicable requirements laid down in the harmonisation of Community legislation on its affixing in accordance with EU Regulation 765/2008.
	UKCA declaration of conformity	SCHURTER AG	The UKCA marking declares that the product complies with the applicable requirements laid down in the British Amendment of Regulation (EC) 765/2008.
	RoHS	SCHURTER AG	Directive RoHS 2011/65/EU, Amendment (EU) 2015/863
	China RoHS	SCHURTER AG	The law SJ / T 11363-2006 (China RoHS) has been in force since 1 March 2007. It is similar to the EU directive RoHS.
	REACH	SCHURTER AG	On 1 June 2007, Regulation (EC) No 1907/2006 on the Registration, Evaluation, Authorization and Restriction of Chemicals 1 (abbreviated as "REACH") entered into force.
		SCHURTER AG	V-Lock system are based on a matching plug-dose combination. The connector is equipped with a notch intended for use with the latching cordset. The cord latching system prevents against accidental removal of the cordset.
	White Paper Glow wire test	SCHURTER AG	Meets the requirements of IEC 60335-1 for appliances in unattended use. This includes the enhanced requirements of glow wire tests acc. to IEC 60695-2-11 or -12 & -13.
	Medical Equipment	SCHURTER AG	Suitable for use in medical equipment according to IEC/UL 60601-1 (1 MOOP, 1 MOPP)

Dimensions [mm]

Screw version A

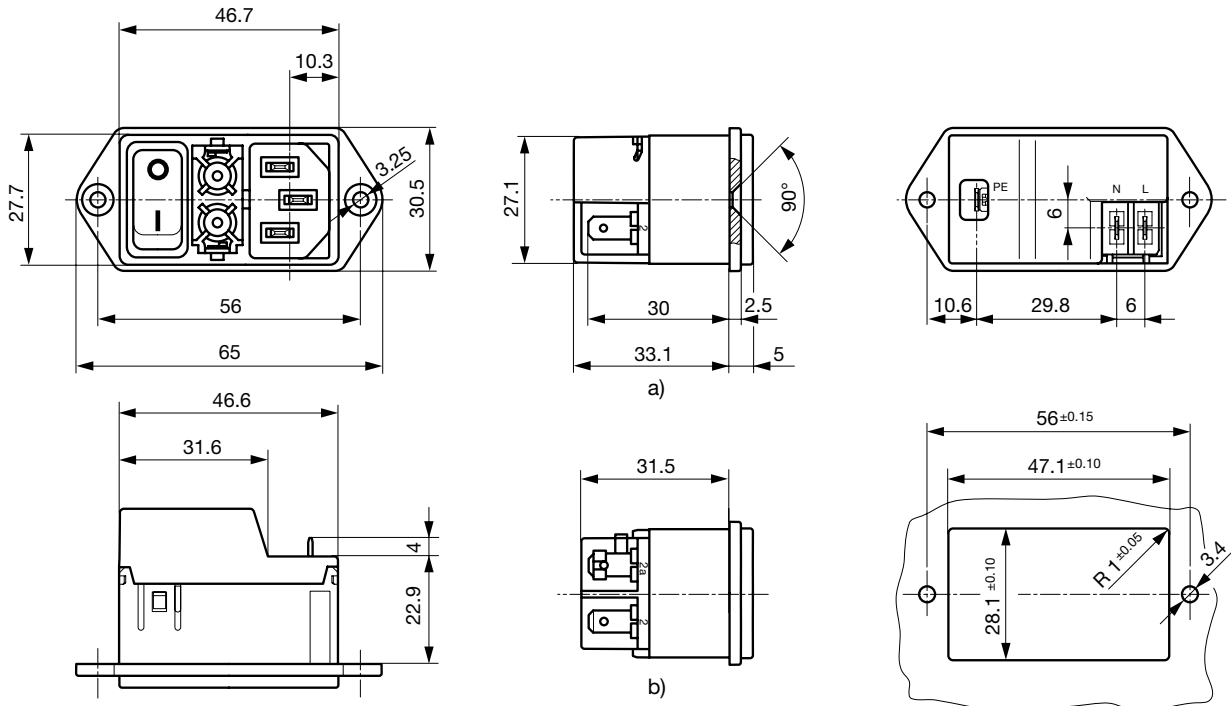

a) view with cover
 b) view without cover

Screw version B

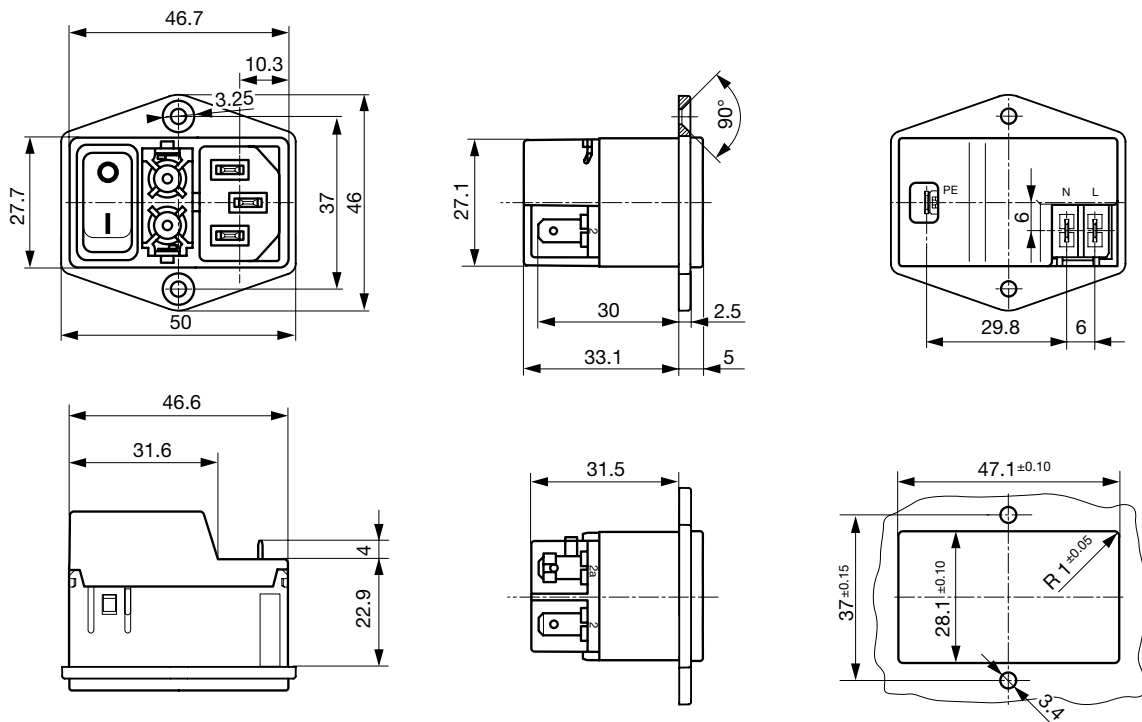

Diagrams

Non-illuminated

illuminated

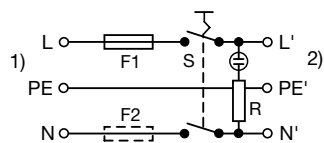
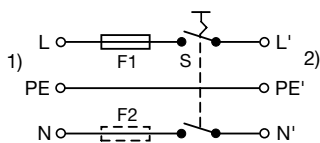

1) Line
2) Load

1) Line
2) Load

Derating Curves

1-pole

2-pole

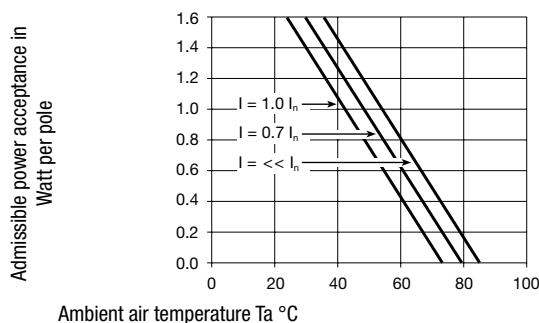
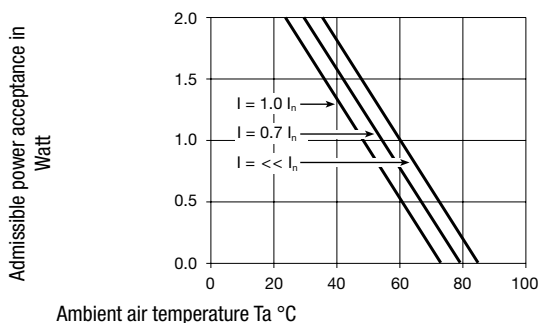

All Variants

Fuseholder	Line Switch	Illumination	Color	Cover	V-Lock	Mounting	Order Number
1-pole	2-pole	illuminated	green		●	B	3-131-462
1-pole	2-pole	non-illuminated	-		●	A	DD11.0111.1110
1-pole	2-pole	illuminated	red		●	A	DD11.0113.1110
1-pole	2-pole	illuminated	green		●	A	DD11.0114.1110
2-pole	2-pole	non-illuminated	-		●	B	3-131-464
2-pole	2-pole	non-illuminated	-		●	A	DD11.0121.1110
2-pole	2-pole	illuminated	red		●	A	DD11.0123.1110
2-pole	2-pole	illuminated	green		●	A	DD11.0124.1110
1-pole	2-pole	non-illuminated	-	●	●	B	3-131-451
1-pole	2-pole	illuminated	green	●	●	B	3-131-463
1-pole	2-pole	non-illuminated	-	●	●	A	DD11.0111.1111
1-pole	2-pole	illuminated	red	●	●	A	DD11.0113.1111
1-pole	2-pole	illuminated	green	●	●	A	DD11.0114.1111
2-pole	2-pole	non-illuminated	-	●	●	B	3-131-465
2-pole	2-pole	illuminated	green	●	●	B	3-131-466
2-pole	2-pole	non-illuminated	-	●	●	A	DD11.0121.1111
2-pole	2-pole	illuminated	red	●	●	A	DD11.0123.1111
2-pole	2-pole	illuminated	green	●	●	A	DD11.0124.1111

Most Popular.

Availability for all products can be searched real-time: <https://www.schurter.com/en/Stock-Check/Stock-Check-SCHURTER>

The fuse drawer is not included and must be ordered separately (see required accessory).





Packaging unit

50 Pcs

Required Accessory

	Description	
	Fusedrawer_2 Fusedrawer for Fuse Links 5x20 mm, with or without Voltage Selector Insert	
	Fingergrip, 2-pole	4301.1401
	Extra-Safe, 2-pole	4301.1403
	Fingergrip, 1-pole	4301.1405
	Extra-Safe, 1-pole	4301.1407
	...	

Accessories

	Wire_Harness Wire harness for SCHURTER products	
	Assorted_Covers Rear Cover	
	RC320 Rear Cover for Power Entry Module	
	Cord_retaining_kits Cord retaining strain relief	
	Flat head, A	4700.0001

Mating Outlets/Connectors

	Category / Description	
	Appliance Outlet Overview complete	
	4787, Mounting: Screw-on mounting, Appliance Outlet: IEC Solder terminals, 10 A, Suitable for appliances with protection class I	4787
	4788, Mounting: Snap-in version, Appliance Outlet: IEC Solder / Quick Connect, 10 A, Suitable for appliances with protection class I	4788
	IEC Appliance Outlet F or H, Screw-on Mounting, Front Side, Solder, PCB or Quick-connect Terminal	5091