

# SMD Transient Voltage Suppressor



## 3.0SMCJ5.0(C)A-HF Thru. 3.0SMCJ170(C)A-HF

Working Peak Reverse Voltage: 5.0 to 170 V

Power Dissipation: 3000 W

RoHS Device  
Halogen Free

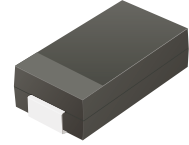

### Features

- For surface mounted applications in order to optimize board space.
- Low profile package.
- Built-in strain relief.
- Glass passivated chip junction.
- 3000W peak pulse power capability at 10x1000μs waveform, repetition rate (duty cycles): 0.01%.
- Excellent clamping capability.
- Low incremental surge resistance.
- Matte tin lead-free plated.

### Mechanical Data

- Case: SMC molded plastic.
- Terminals: Solderable per MIL-STD-750, method 2026.

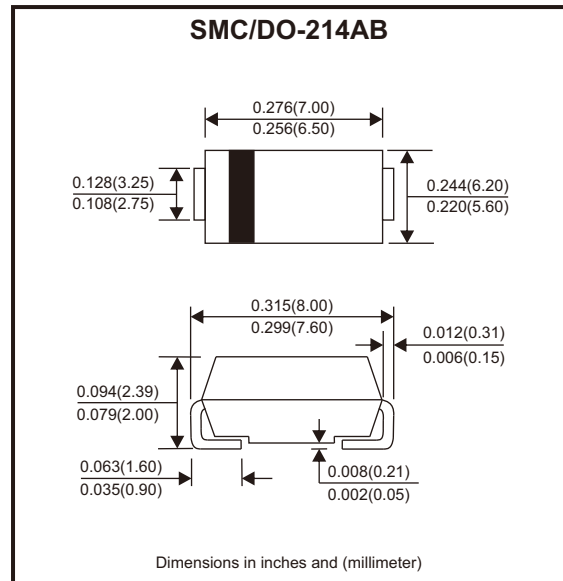

### Circuit Diagram

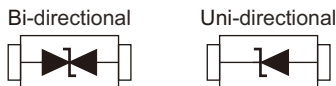

### Maximum Ratings and Electrical Characteristics (TA = 25°C unless otherwise noted)

Characteristics	Symbol	Value	Units
Peak pulse power dissipation at TA = 25°C by 10 x 1000μs waveform (Fig.1) (Note 1, 2)	P <sub>PPM</sub>	3000	W
Power dissipation on infinite heat sink at TA = 50°C	P <sub>M(AV)</sub>	6.5	W
Peak forward surge current, 8.3ms single half sine wave (Note 3)	I <sub>FSM</sub>	300	A
Maximum instantaneous forward voltage at 100A for unidirectional only	V <sub>F</sub>	3.5	V
Operating junction and storage temperature range	T <sub>J</sub> , T <sub>STG</sub>	-65 to +150	°C
Typical thermal resistance junction to lead	R <sub>θJL</sub>	15	°C/W
Typical thermal resistance junction to ambient	R <sub>θJA</sub>	75	°C/W

Notes: 1. Non-repetitive current pulse. per Fig 3 and derated above Ta= 25°C per Fig. 2.  
 2. Mounted on copper pad area of 0.31 x 0.31" (8.0 x 8.0mm) to each terminal.  
 3. Mounted on 8.3ms single half sine wave or equivalent square wave for unidirectional device only, duty cycle = 4 per minute maximum.

# SMD Transient Voltage Suppressor

## Electrical Characteristics (3.0SMCJ5.0(C)A-HF Thru. 3.0SMCJ170(C)A-HF)

Part No.	Reverse stand-off voltage	Breakdown voltage V <sub>BR</sub> @ I <sub>T</sub>		Test current	Max. clamp voltage V <sub>C</sub> @ I <sub>PP</sub>	Max. peak pulse current	Max. reverse leakage I <sub>R</sub> @ V <sub>R</sub>	Device Marking Code	
	V <sub>RWM</sub> (V)	Min (V)	Max (V)	I <sub>T</sub> (mA)	(V)	I <sub>PP</sub> (A)	(μA)	UNI	BI
3.0SMCJ5.0(C)A-HF	5.0	6.40	7.00	10	9.2	326.1	800	RDE	DDE
3.0SMCJ6.0(C)A-HF	6.0	6.67	7.37	10	10.3	291.3	800	RDG	DDG
3.0SMCJ6.5(C)A-HF	6.5	7.22	7.98	10	11.2	267.9	500	RDK	DDK
3.0SMCJ7.0(C)A-HF	7.0	7.78	8.60	10	12.0	250.0	200	PDM	DDM
3.0SMCJ7.5(C)A-HF	7.5	8.33	9.21	1	12.9	232.6	100	PDP	DDP
3.0SMCJ8.0(C)A-HF	8.0	8.89	9.83	1	13.6	220.6	50	PDR	DDR
3.0SMCJ8.5(C)A-HF	8.5	9.44	10.40	1	14.4	208.3	20	PDT	DDT
3.0SMCJ9.0(C)A-HF	9.0	10.00	11.10	1	15.4	194.8	10	PDV	DDV
3.0SMCJ10(C)A-HF	10.0	11.10	12.30	1	17.0	176.5	5	PDX	DDX
3.0SMCJ11(C)A-HF	11.0	12.20	13.50	1	18.2	164.8	2	PDZ	DDZ
3.0SMCJ12(C)A-HF	12.0	13.30	14.70	1	19.9	150.8	2	PEE	DEE
3.0SMCJ13(C)A-HF	13.0	14.40	15.90	1	21.5	139.5	2	PEG	DEG
3.0SMCJ14(C)A-HF	14.0	15.60	17.20	1	23.2	129.3	2	PEK	DEK
3.0SMCJ15(C)A-HF	15.0	16.70	18.50	1	24.4	123.0	2	PEM	DEM
3.0SMCJ16(C)A-HF	16.0	17.80	19.70	1	26.0	115.4	2	PEP	DEP
3.0SMCJ17(C)A-HF	17.0	18.90	20.90	1	27.6	108.7	2	PER	DER
3.0SMCJ18(C)A-HF	18.0	20.00	22.10	1	29.2	102.7	2	PET	DET
3.0SMCJ20(C)A-HF	20.0	22.20	24.50	1	32.4	92.6	2	PEV	DEV
3.0SMCJ22(C)A-HF	22.0	24.40	26.90	1	35.5	84.5	2	PEX	DEX
3.0SMCJ24(C)A-HF	24.0	26.70	29.50	1	38.9	77.1	2	PEZ	DEZ
3.0SMCJ26(C)A-HF	26.0	28.90	31.90	1	42.1	71.3	2	PFE	DFE
3.0SMCJ28(C)A-HF	28.0	31.10	34.40	1	45.4	66.1	2	PFG	DFG
3.0SMCJ30(C)A-HF	30.0	33.30	36.80	1	48.4	62.0	2	PFK	DFK
3.0SMCJ33(C)A-HF	33.0	36.70	40.60	1	53.3	56.3	2	PFM	DFM
3.0SMCJ36(C)A-HF	36.0	40.00	44.20	1	58.1	51.6	2	PFP	DFP
3.0SMCJ40(C)A-HF	40.0	44.40	49.10	1	64.5	46.5	2	PFR	DFR
3.0SMCJ43(C)A-HF	43.0	47.80	52.80	1	69.4	43.2	2	PFT	DFT
3.0SMCJ45(C)A-HF	45.0	50.00	55.30	1	72.7	41.3	2	PFV	DFV
3.0SMCJ48(C)A-HF	48.0	53.30	58.90	1	77.4	38.8	2	PFX	DFX
3.0SMCJ51(C)A-HF	51.0	56.70	62.70	1	82.4	36.4	2	PFZ	DFZ
3.0SMCJ54(C)A-HF	54.0	60.00	66.30	1	87.1	34.4	2	RGE	DGE
3.0SMCJ58(C)A-HF	58.0	64.40	71.20	1	93.6	32.1	2	PGG	DGG
3.0SMCJ60(C)A-HF	60.0	66.70	73.70	1	96.8	31.0	2	PGK	DGK
3.0SMCJ64(C)A-HF	64.0	71.10	78.60	1	103.0	29.1	2	PGM	DGM
3.0SMCJ70(C)A-HF	70.0	77.80	86.00	1	113.0	26.5	2	PGP	DGP
3.0SMCJ75(C)A-HF	75.0	83.30	92.10	1	121.0	24.8	2	PGR	DGR
3.0SMCJ78(C)A-HF	78.0	86.70	95.80	1	126.0	23.8	2	PGT	DGT
3.0SMCJ85(C)A-HF	85.0	94.40	104	1	137.0	21.9	2	PGV	DGV
3.0SMCJ90(C)A-HF	90.0	100	111	1	146.0	20.5	2	PGX	DGX
3.0SMCJ100(C)A-HF	100	111	123	1	162.0	18.5	2	PGZ	DGZ
3.0SMCJ110(C)A-HF	110	122	135	1	177.0	16.9	2	PHE	DHE
3.0SMCJ120(C)A-HF	120	133	147	1	193.0	15.5	2	PHG	DHG
3.0SMCJ130(C)A-HF	130	144	159	1	209.0	14.4	2	PHK	DHK
3.0SMCJ150(C)A-HF	150	167	185	1	243.0	12.3	2	PHM	DHM
3.0SMCJ160(C)A-HF	160	178	197	1	259.0	11.6	2	PHP	DHP
3.0SMCJ170(C)A-HF	170	189	209	1	275.0	10.9	2	PHR	DHR

Note: For Bi-directional devices, use suffix CA.

Company reserves the right to improve product design , functions and reliability without notice. REV:C

## Rating and Characteristic Curves (3.0SMCJ5.0(C)A-HF Thru. 3.0SMCJ170(C)A-HF)

Fig.1 - Peak Pulse Power Rating Curve

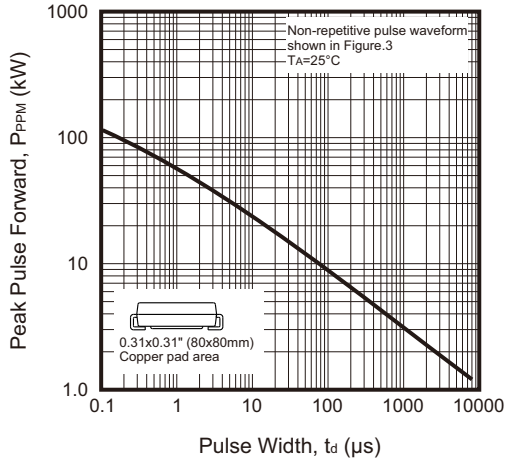

Fig.2 - Forward Current Derating Curve

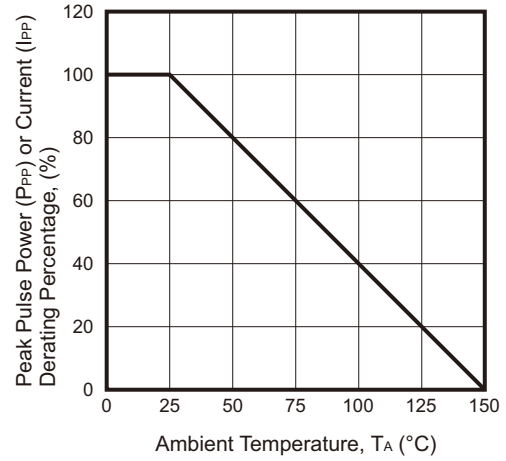

Fig.3 - Pulse Waveform

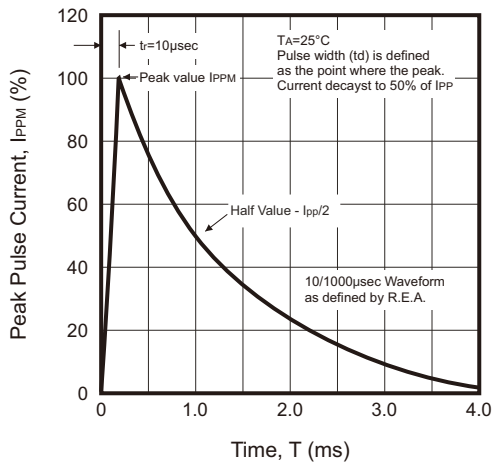

Fig.4 - Typical Junction Capacitance

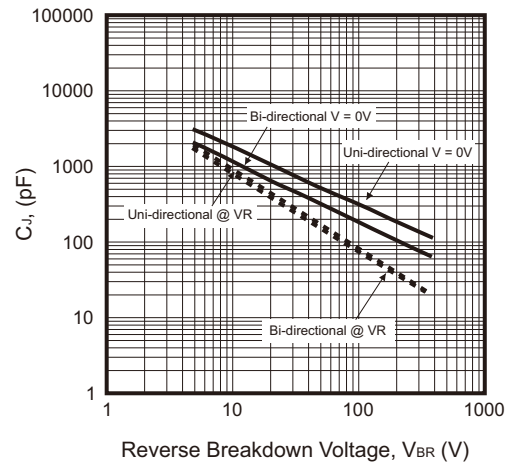

Fig.5 - Steady State Power Derating Curve

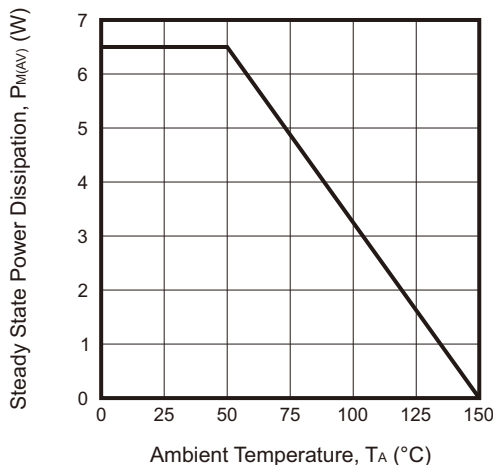
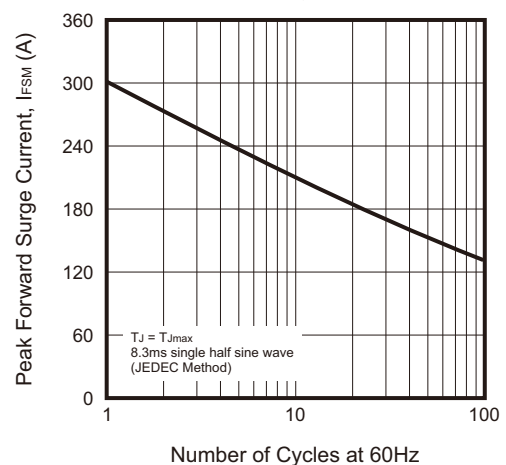
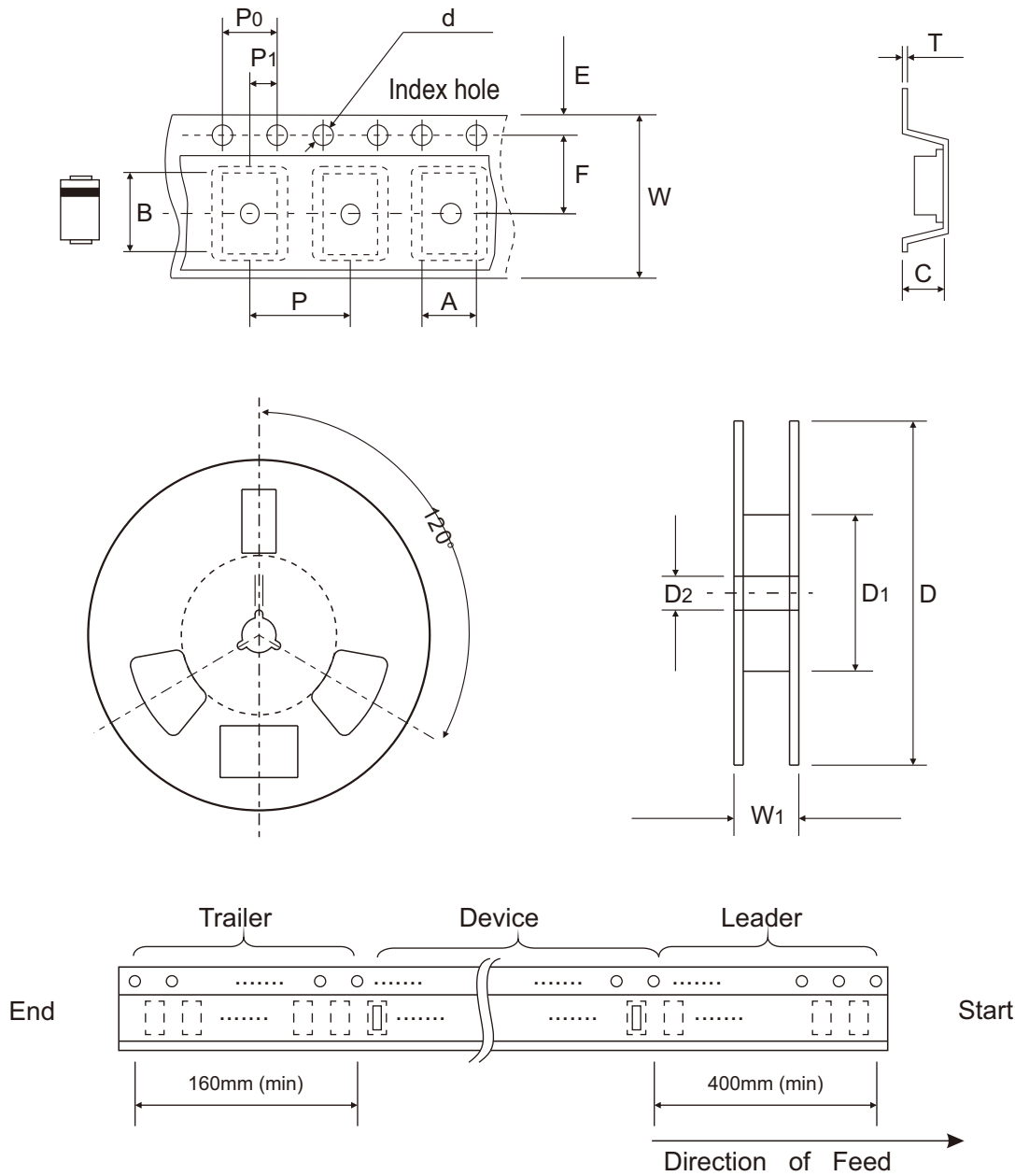

Fig.6 - Maximum Non-Repetitive Peak Forward Surge Current



## Reel Taping Specification



DO-214AB (SMC)	SYMBOL	A	B	C	d	D	D1	D2
	(mm)	6.22 ± 0.10	8.31 ± 0.10	2.49 ± 0.10	1.55 ± 0.05	330 ± 2.00	100.00 ± 1.00	13.00 ± 0.20
	(inch)	0.245 ± 0.004	0.327 ± 0.004	0.098 ± 0.004	0.061 ± 0.002	12.992 ± 0.079	3.937 ± 0.039	0.512 ± 0.008

DO-214AB (SMC)	SYMBOL	E	F	P	P0	P1	T	W	W1
	(mm)	1.75 ± 0.10	7.50 ± 0.10	8.00 ± 0.10	4.00 ± 0.10	2.00 ± 0.05	0.28 ± 0.02	16.00 ± 0.30	21.00 + 2.00 - 1.00
	(inch)	0.069 ± 0.004	0.295 ± 0.004	0.315 ± 0.004	0.157 ± 0.004	0.079 ± 0.002	0.011 ± 0.001	0.630 ± 0.012	0.827 + 0.079 - 0.039

Company reserves the right to improve product design, functions and reliability without notice. REV:C