

Description

Combination of single pole circuit breaker and ON/OFF switch with soft-touch rocker actuation. Contoured rockers are available with a choice of colours and legends, with optional illumination. The 3131 is sealed to provide IP66 rated front of panel water splash protection. It meets the requirements of circuit breaker standard EN 60934 (IEC 60934): S type, TO.

Typical applications

Motor protection, transformer protection, household appliances and office equipment, electrical tools, mobile homes, watercraft, construction vehicles, medical equipment.

Current ratings and typical internal resistance values

Current rating (A)	Internal resistance (Ω)	Current rating (A)	Internal resistance (Ω)
0.1	94	4	0.0435
0.2	24	5	0.0325
0.3	12	6	0.0215
0.4	5.30	7	0.0165
0.5	4.20	8	0.0165
0.8	1.50	10	< 0.02
1	0.9	12	< 0.02
1.2	0.80	14	< 0.02
1.5	0.45	15	< 0.02
2	0.27	16	< 0.02
2.5	0.0785	18	< 0.02
3	0.0595	20	< 0.02
3.5	0.0565		

Illumination voltage / power consumption

operating voltage	power consumption (LED)	
	Y = yellow	T = blue
12 V	10 mA	10 mA
24 V	10 mA	10 mA
115 V	< 1 mA	-
230 V	< 1 mA	-

Approvals

Authority	Standard	Rated voltage	Current ratings
VDE	IEC 60934	AC 240 V DC 32 V	0.05 A...20 A 0.05 A...20 A
UL	UL 1077 C22.2 No 235 UL 1500 Ignition Protected	AC 250 V DC 50 V DC 32 V	0.1 A...20 A 2 A...20 A 0.1 A...20 A



Technical data

For further details please see: http://www.e-t-a.de/ti_e

Voltage rating	AC 240 V; DC 28 V
Current rating range	0.1...20 A
Typical life	0.1...20 A 30,000 operations at $1 \times I_N$, inductive
Ambient temperature	-20...+60 °C (-4...+140 °F)
Insulation co-ordination (IEC 60664)	2.5 kV/2 re-inforced insulation in the operating area
Dielectric strength operating area	test voltage AC 3,000 V
current path/current path	test voltage AC 1,500 V
Insulation resistance	> 100 M Ω (DC 500 V)
Interrupting capacity I_{cn}	0.1...2 A $10 \times I_N$ 2.5...20 A 200 A
Interrupting capacity (UL 1077)	0.1...16 A: AC 240 V 3,000 A DC 32 V 2,500 A
Protection class (IEC 60529)	operating area IP66 terminal area IP00
Vibration	5 g (57-500 Hz) \pm 0.38 mm (10-57 Hz) test to IEC 60068-2-6, test Fc, 10 frequency cycles/axis
Shock	25 g (11 ms), test to IEC 60068-2-27, test Ea
Corrosion	96 hours at 5 % salt mist, test to IEC 60068-2-11, test Ka
Humidity	240 hours at 95 % RH, test to IEC 60068-2-78, test Cab
Mass	approx. 30 g

Ordering Information

Type number

3131 single pole thermal circuit breaker

Function

- A circuit breaker single pole, latching switch
- C circuit breaker single pole, momentary switch

Mounting

F flange mounting

Accessories

1 with sealing IP66

Terminal design

H terminal 1: screws M3.5x5 ISO 1580 (DIN 85)
terminal 2: blade terminal for 1x6.3x0.8 mm or 2x2.8x0.8 EN 60934 connectors

N terminals 1,2 and 4: blade terminal for 1x6.3x0.8 mm or 2x2.8x0.8 EN 60934 connectors

P terminals 1 and 2: blade terminal for 1x6.3x0.8 mm or 2x2.8x0.8 EN 60934 connectors

Characteristic curve

T thermal 1.0 – 1.4 times rated current

Actuator style

0 without actuator
rocker X3131-W... must be ordered separately

Actuator colour

0 without actuator

Rocker legends

00 without

Rocker marking

0 without

Orientation

0 without

Illumination

- 1 illuminated when in position 1 (ON)
- 3 as 1, with dimmed illumination of window 1

Type of illumination

- T blue LED
- Y yellow LED

Illumination voltage range

- 0 without illumination
- 2 10 - 14 V DC
- 3 20 - 32 V DC
- 7 185 - 275 V AC

Current ratings

0.1...20 A

3131 - A F 1 P T - 0 0 00 0 0 - 1 Y 3 - 10 A ordering example

Please be informed that we have minimum ordering quantities to be observed.

Dimensions

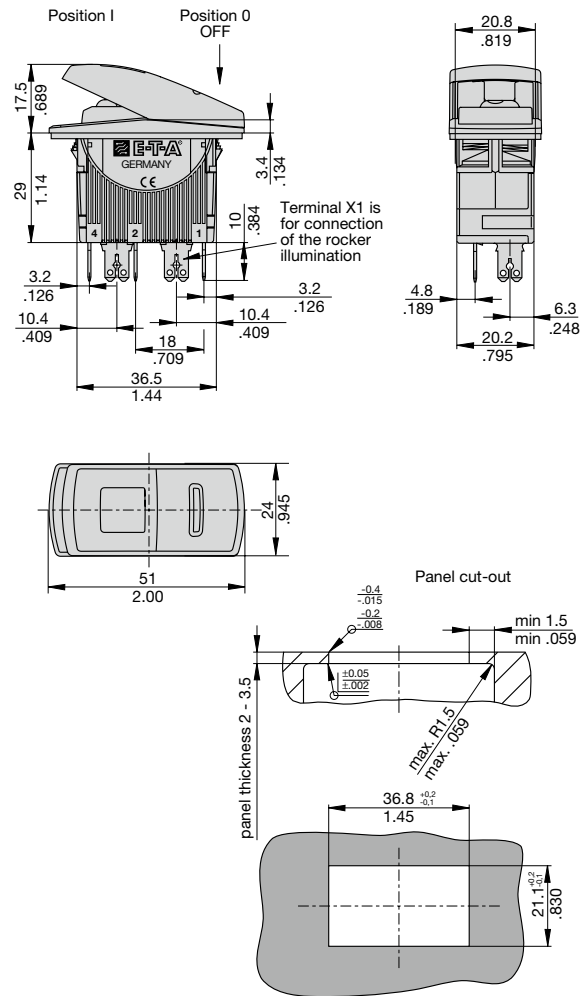

Installation drawing

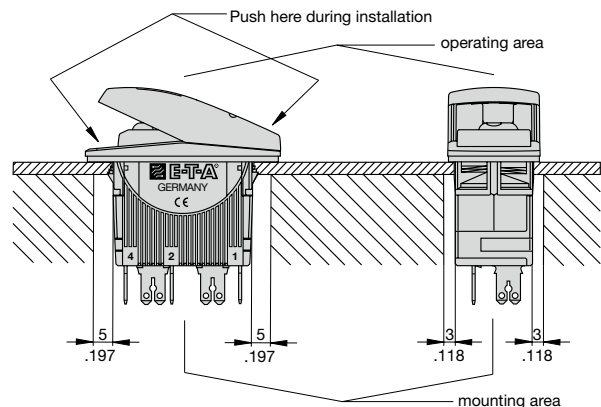

This is a metric design and millimeter dimensions take precedence (mm/inch)

Internal connection diagrams

circuit breaker

1-pole switch

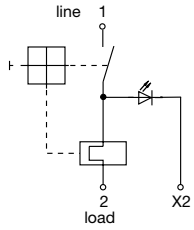

1-pole momentary switch

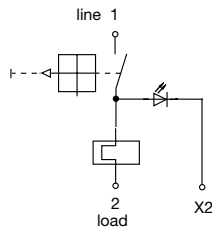

switch

1-pole switch

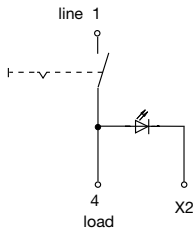

1-pole momentary switch

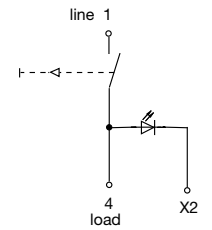

Typical time/current characteristics

0.1 ... 2 A

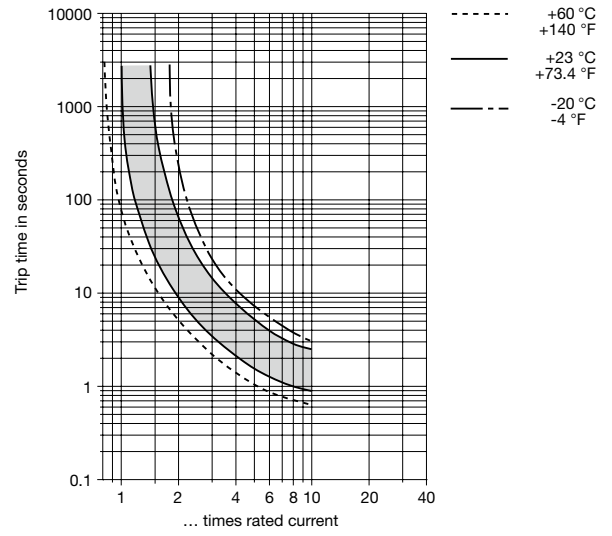

2.5 ... 20 A

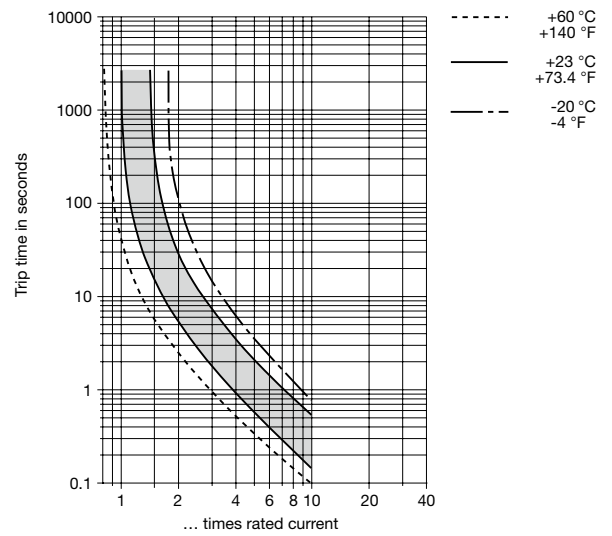





























The time/current characteristic curve depends on the ambient temperature prevailing. In order to eliminate nuisance tripping, please multiply the circuit breaker current ratings by the derating factor shown below. See also section Technical information.

Ambient temperature °F	-4	+14	+32	+73.4	+104	+122	+140
°C	-20	-10	0	+23	+40	+50	+60
Derating factor	0.84	0.88	0.92	1	1.08	1.14	1.23



List of available legends

		Ordering information
Interior light		01
Anchor light		02
Cockpit light		03
Navigation light		04
UKW-radio		05
Refrigerator		06
Anchor		07
Windshield wiper		08
Bilge pump		09
Potable water		10
Horn		11
Ventilation fan		12
Panel light		13
Navigation instruments		14
Music		15
Heating		16
Shower pump		17
Icebox		19
Screenwash		20
Search light		23
Autopilot		24
Trim tabs		25
Mast lift		26

		Ordering information
Navigation light (sailing ship)		27
Cockpit light (sailing ship)		28
Deck light (sailing ship)		29
Anchor light (sailing ship)		30
Toilet		31
Outlet		41

Further symbols upon request

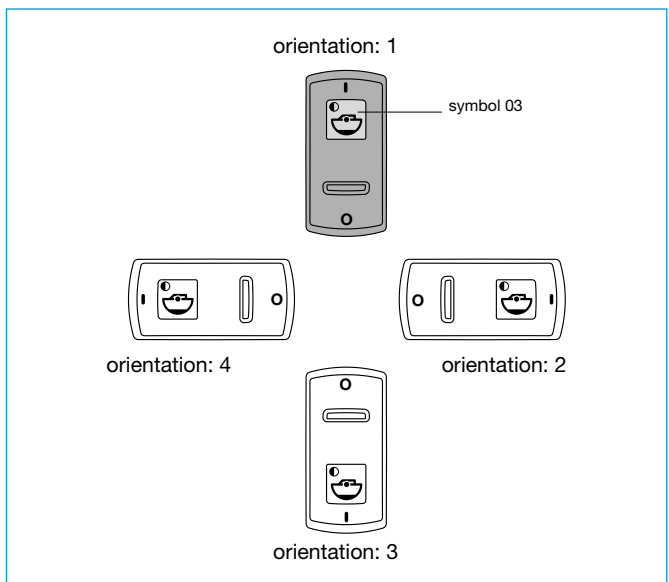

Ordering Information X3131-...

Type number	X3131	module for type 3131
Actuator style	W	rocker soft-touch, two illumination windows
Actuator colour	A	blue / white translucent
	B	black / white translucent
	C	skyblue / white translucent
Rocker legends	00	without
	...	see separate survey of legends
Rocker marking	0	without
	A	I and 0
Orientation	0	without orientation
	1	orientation 1 (standard)
	2	orientation 2
	3	orientation 3
	4	orientation 4
Ordering example	X3131 - W A 01 0 1	

Accessories

Mounting frame

Consisting of a left- and right-side piece, can be expanded by a centre piece.
 (Please order 2 side pieces per mounting frame)
 The pieces firmly engage when stuck together.

side piece Y 308 790 01
centre piece Y 308 791 01

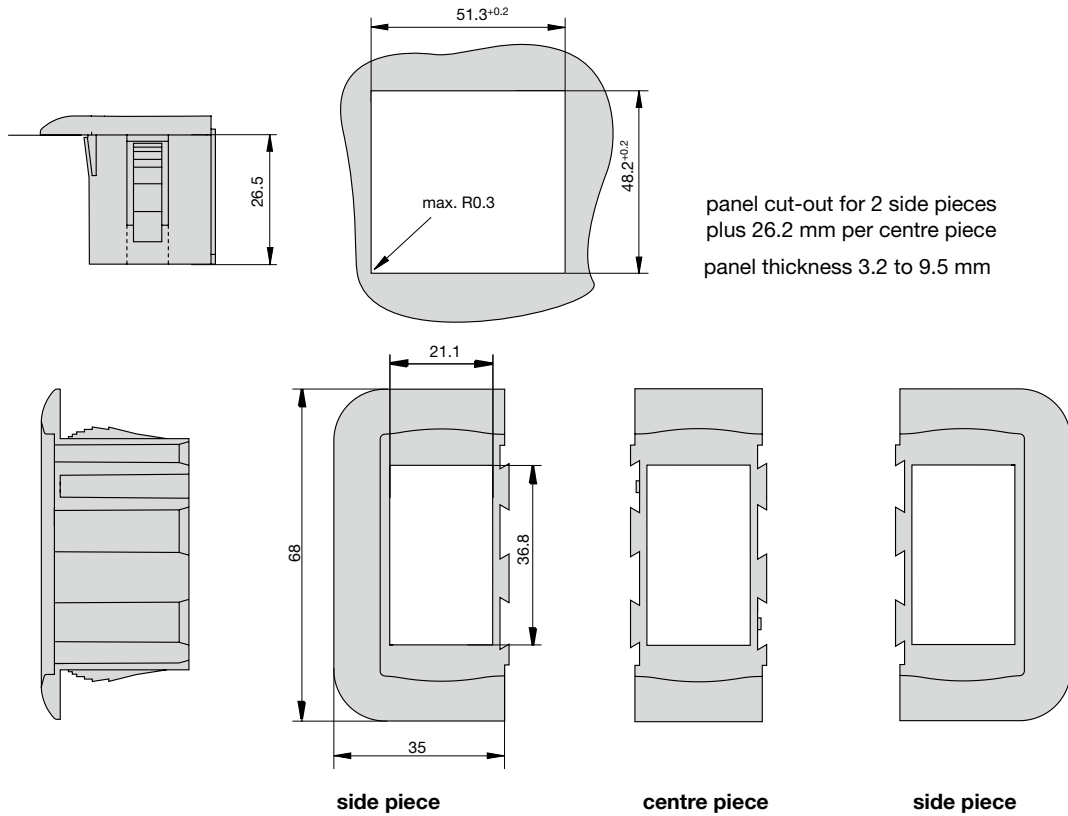

1

This is a metric design and millimeter dimensions take precedence (mm / inch)

All dimensions without tolerances are for reference only. In the interest of improved design, performance and cost effectiveness the right to make changes in these specifications without notice is reserved. Product markings may not be exactly as the ordering codes. Errors and omissions excepted.