

PRODUCT DATA DRAWING

REVISION HISTORY			
REV	DESCRIPTION	DATE	APPROVED
-	NRN 44733	04/20	STW
A	DCN 49924	06/20	STW

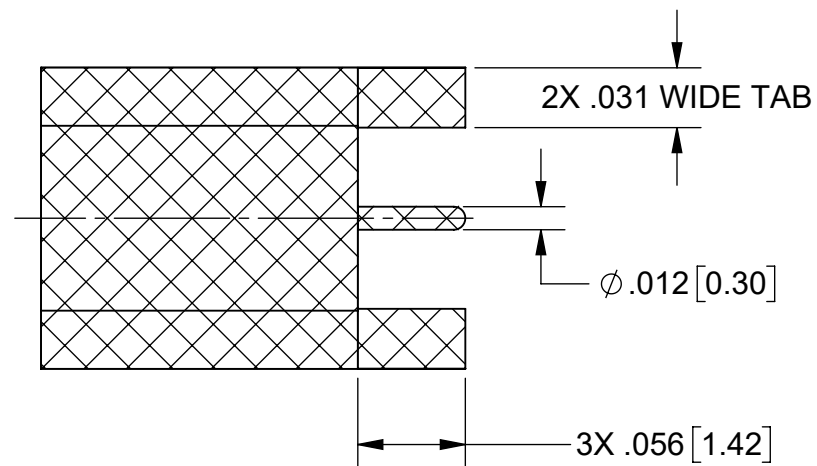
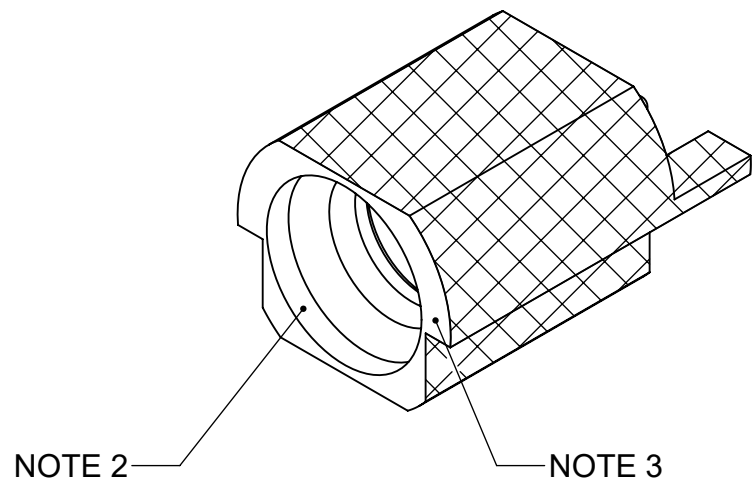

NOTES:

1. Sn63 SOLDER REQUIRED IN HATCHED AREAS AS SHOWN.
2. NO SOLDER ALLOWED IN INTERFACE.
3. SOLDER SPLASH ALLOWABLE ON THIS FACE.
4. CONNECTOR MUST BE FLUSH TO BOARD FOR OPTIMAL RF PERFORMANCE.
5. PART TO BE SHIPPED WITH TAPE AND REEL.
6. FOR A FOOTPRINT RECOMMENDATION SPECIFIC TO YOUR PCB, PLEASE CONTACT US AT applications@svmicro.com

MATERIAL:

BODY: STAINLESS STEEL PER AMS-5640 OR ASTM A582 ALLOY S30300, TYPE 303, CONDITION A.

CONTACT: BERYLLIUM COPPER PER ASTM B196, ALLOY No. UNS C17300, TD04

INSULATOR: PTFE PER ASTM D1710, TYPE I, GRADE 1, CLASS B

FINISH:

BODY & CONTACT: GOLD PER ASTM B488, TYPE II, CODE C, CLASS .76 (.000030" MIN), OVER NICKEL PER AMS-QQ-N-290, CLASS 1, .000050" MIN

PERFORMANCE:

IMPEDANCE: 50 OHMS
FREQ. RANGE: DC TO 40.0 GHz
INSUL. RES.: 5000 MEGOHMS, MIN.

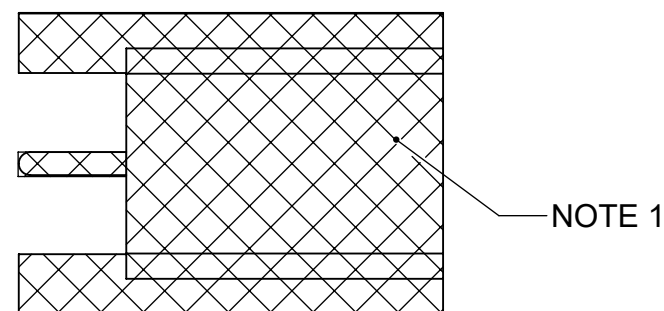
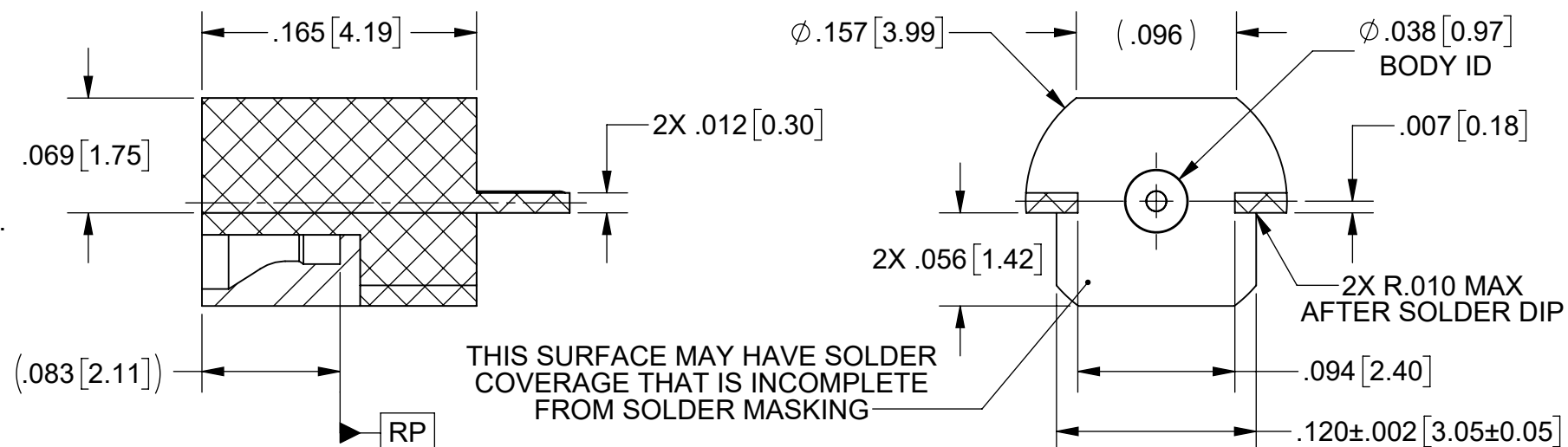

SV PART NUMBER	INTERFACE
3211-60307	SMOOTH BORE
3211-60308	FULL DETENT

MATERIAL: SEE NOTES	DIMENSIONS ARE IN INCHES TOLERANCES: FRACTIONAL: $\pm 1/64$ ANGULAR: X° $\pm 1'0''$ X°X' $\pm 15''$	UNLESS OTHERWISE SPECIFIED 1) ALL DIMENSIONS ARE IN INCHES (MILLIMETERS) 2) ALL DIMENSIONS ARE AFTER PLATING. 3) BREAK CORNERS & EDGES .005 R. MAX. 4) CHAM. 1ST & LAST THREADS. 5) SURFACE ROUGHNESS 63-MIL-STD-10. 6) DIA: 'S ON COMMON CENTERS TO BE CONCENTRIC WITHIN .005 T.I.R. 7) REMOVE ALL BURRS	 Amphenol www.svmicrowave.com TITLE: SMPM MALE STRAIGHT PCB EDGE MOUNT
FINISH: SEE NOTES	DECIMAL: X $\pm .030$.XX $\pm .010$.XXX $\pm .005$		
SURFACE AREA: N/A	INTERPRET DIMENSIONS AND TOLERANCES PER ASME Y14.5M - 1994	DRAWN: DTL 04/03/20	SIZE DWG. NO. 3211-60307-60308
PROPRIETARY THE INFORMATION CONTAINED IN THIS DRAWING IS THE SOLE PROPERTY OF SV MICROWAVE, INC. ANY REPRODUCTION IN PART OR AS A WHOLE WITHOUT THE WRITTEN PERMISSION OF SV MICROWAVE, INC IS PROHIBITED.	THIRD ANGLE PROJECTION	CHECKED: STW 04/03/20	SCALE: 16:1
		APPROVED: STW 04/03/20	SHEET 1 OF 2

REVISION HISTORY			
REV	DESCRIPTION	DATE	APPROVED
-	NRN 44733	04/20	STW

RECOMMENDED PCB MECHANICAL FOOTPRINT

2X ZERO CORNER BREAK:
ENSURE ZERO TO NO RADIUS SO
CONNECTOR SITS FLUSH TO FACE

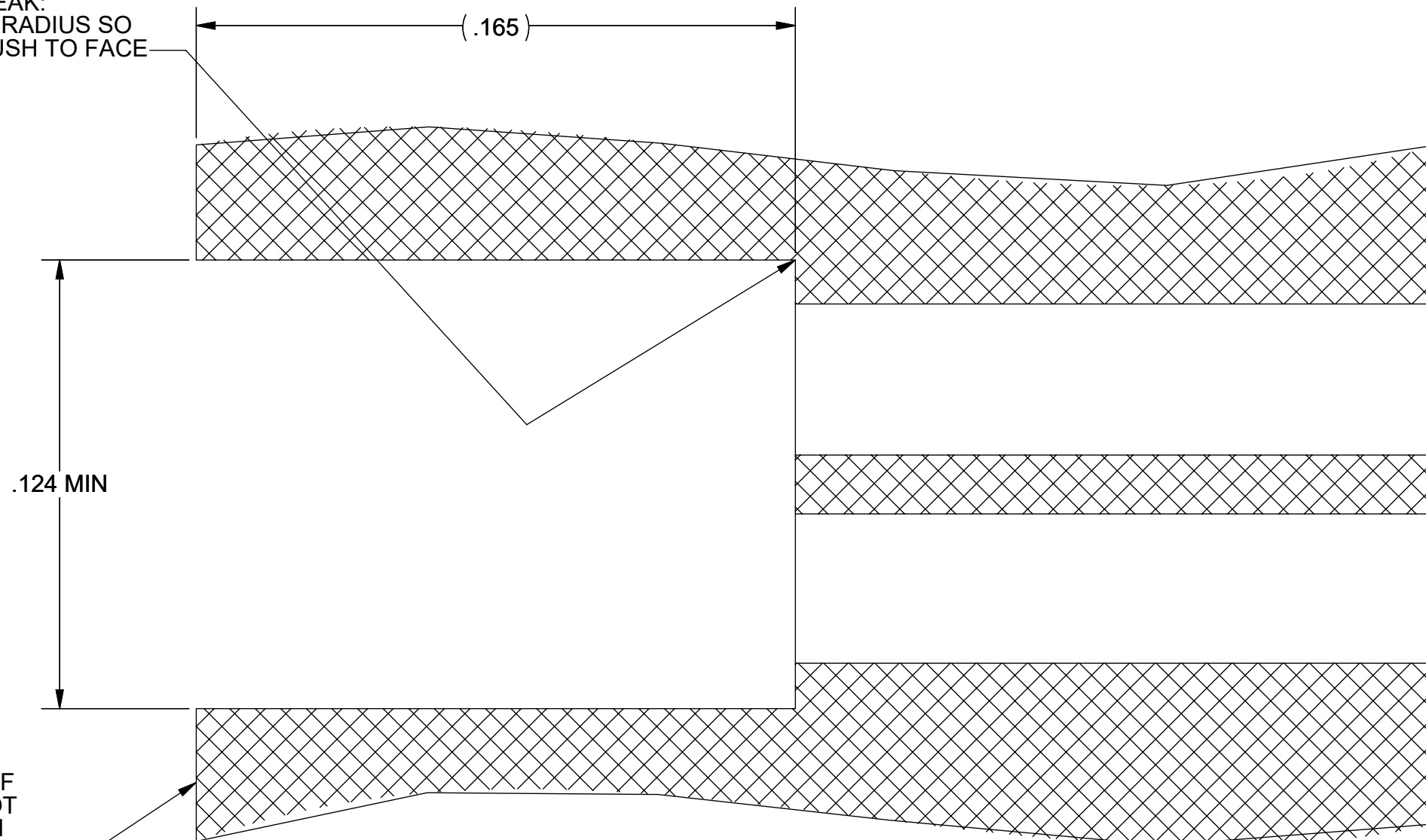

ENSURE EDGE OF
BOARD DOES NOT
INTERFERE WITH
MATING CONNECTOR

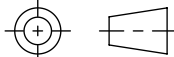
MATERIAL: SEE NOTES	DIMENSIONS ARE IN INCHES TOLERANCES: FRACTIONAL: $\pm 1/64$ ANGULAR: $X^\circ \pm 1'0''$ $X^\circ X' \pm 15''$	UNLESS OTHERWISE SPECIFIED 1) ALL DIMENSIONS ARE IN INCHES (MILLIMETERS) 2) ALL DIMENSIONS ARE AFTER PLATING. 3) BREAK CORNERS & EDGES .005 R. MAX. 4) CHAM. 1ST & LAST THREADS. 5) SURFACE ROUGHNESS 63-MIL-STD-10. 6) DIA: 'S ON COMMON CENTERS TO BE CONCENTRIC WITHIN T.I.R. 7) REMOVE ALL BURRS	 www.svmicrowave.com TITLE: SMPM MALE STRAIGHT PCB EDGE MOUNT
FINISH: SEE NOTES	DECIMAL: X $\pm .030$.XX $\pm .010$.XXX $\pm .005$		
SURFACE AREA: N/A	INTERPRET DIMENSIONS AND TOLERANCES PER ASME Y14.5M - 1994	DRAWN: DTL 04/03/20	SIZE DWG. NO. B 3211-60307-60308
PROPRIETARY THE INFORMATION CONTAINED IN THIS DRAWING IS THE SOLE PROPERTY OF SV MICROWAVE, INC. ANY REPRODUCTION IN PART OR AS A WHOLE WITHOUT THE WRITTEN PERMISSION OF SV MICROWAVE, INC IS PROHIBITED.	THIRD ANGLE PROJECTION 	CHECKED: STW 04/03/20	SCALE: 16:1
		APPROVED: STW 04/03/20	SHEET 2 OF 2