

THIS DOCUMENT IS THE PROPERTY OF
KEYSTONE ELECTRONICS CORP. AND
SHALL NOT BE REPRODUCED, DISTRIBUTED
OR USED AS A BASIS FOR MANUFACTURE
WITHOUT PRIOR WRITTEN PERMISSION
FROM KEYSTONE ELECTRONICS CORP.

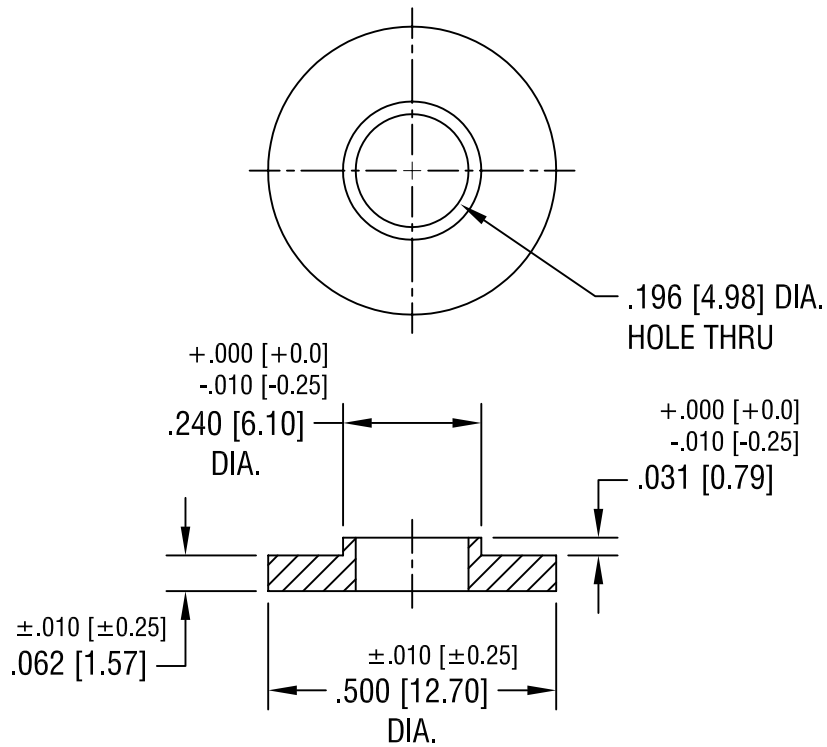

KEYSTONE ELECTRONICS CORP.

ASTORIA, N.Y. 11105-2017

PART NAME

FIBRE SHOULDER WASHER

MATERIAL

VULCANIZED FIBRE

FINISH

-

DRN BY

BOONE

DATE

11.6.06

APP'D

LN

SCALE

3X

TOLERANCES

INCH

[MM]

CODE

DWG NO.

DECIMAL $\pm .005$ [± 0.15]

C/M

ANGULAR $\pm 1^\circ$
UNLESS OTHERWISE SPECIFIED

3239

DATE

DESCRIPTION

REV.