

Features

- Conductive plastic
- PC board and bushing mount
- Plastic or metal bushing and plastic shaft
- Withstands typical industrial washing processes
- Compact package saves board and panel space

3310 – 9 mm Square Sealed Panel Control

Electrical Characteristics¹

Standard Resistance Range - Linear	1 K ohms to 1 megohm
Total Resistance Tolerance - Linear Tapers	±20 %
Independent Linearity	±5 %
End Resistance	2 % or 2 ohms maximum (whichever is greater)
Effective Electrical Angle	270 ° ±15 °
Contact Resistance Variation	1 % or 1 ohm (whichever is greater)
Dielectric Withstanding Voltage (MIL-STD-202 – Method 301)	
Sea Level	900 VAC minimum
70,000 Feet	350 VAC minimum
Insulation Resistance	1,000 megohms minimum
Power Rating @ 70 °C (Derate to 0 at 125 °C - Voltage Limited By Power Dissipation or 200 VAC, Whichever is Less)	0.25 watts
Theoretical Resolution	Essentially infinite

Environmental Characteristics

Operating Temperature Range	-40 °C to +125 °C (-40 °F to +257 °F)
Storage Temperature Range	-55 °C to +125 °C (-67 °F to +257 °F)
Temperature Coefficient Over Storage Temperature Range	±1,000 ppm/°C
Vibration	30 G
Total Resistance Shift	±1 % maximum
Voltage Ratio Shift	±1 % maximum
Shock	100 G
Total Resistance Shift	±1 % maximum
Voltage Ratio Shift	±1 % maximum
Load Life	1,000 hours
Total Resistance Shift	±10 % TRS maximum
Rotational Life (No Load)	50,000 cycles
Total Resistance Shift	±5 % TRS maximum
Contact Resistance Variation	3 % or 3 ohms (whichever is greater)
Moisture Resistance	MIL-STD-202, Method 103, Condition B
Total Resistance Shift	±10 % TRS maximum
IP Rating	IP67
Moisture Sensitivity Level	1
ESD Classification (HBM)	N/A

Mechanical Characteristics

Stop Strength	5.65 N-cm (8 oz.-in.)
Mechanical Angle	300 ° nominal
Torque	
Starting	3.53 N-cm (5.0 oz.-in.) maximum
Running	3.53 N-cm (5.0 oz.-in.) maximum
Mounting (Torque on Bushing)	45 N-cm (4.0 lb.-in.) max [plastic bushing]; 79 N-cm (7.0 lb.-in.) max [metal bushing]
Weight (Single Section)	4.5 grams
(Each Additional Section)	2.5 grams
Terminals	Solderable pins
Soldering Condition	
Manual Soldering	96.5Sn/3.0Ag/0.5Cu solid wire or no-clean rosin cored wire; 370 °C (700 °F) max. for 3 seconds
Wave Soldering	96.5Sn/3.0Ag/0.5Cu solder with no-clean flux; 260 °C (500 °F) max. for 5 seconds
Wash Processes	For recommended wash processes, please refer to http://www.bourns.com/pdfs/sldclen.pdf
Marking	Manufacturer's trademark, model number, product code, terminal style, resistance code and date code
Ganging	2 cups maximum
Hardware	One lockwasher (H-37-5) and one mounting nut (H-38-1) is shipped with each potentiometer, except bushingless versions
Flammability	Conforms to UL94V-0
Epoxy	Conforms to UL 94V-1
IP Rating	IP67

Switch Characteristics

Switch Life	10K cycles
Contact Resistance	2 ohms max.
Dielectric Strength	350 VDC
Detent Torque	0.5 oz-in min.
Power Rating (Resistive Load)	100 mA @ 16 VDC

¹Electrical specifications tested at 60 RPM, at room ambient: +25 °C nominal.



WARNING
Cancer and Reproductive Harm
www.P65Warnings.ca.gov

*RoHS Directive 2015/863, Mar 31, 2015 and Annex.
 Specifications are subject to change without notice. Users should verify actual device performance in their specific applications. The products described herein and this document are subject to specific legal disclaimers as set forth on the last page of this document, and at www.bourns.com/docs/legal/disclaimer.pdf.

Additional Features

- Audio taper versions available as special order
- RoHS compliant*

3310 – 9 mm Square Sealed Panel Control

BOURNS®

Standard Resistance Table

Resistance (Ohms)	Resistance Code
1,000	102
2,000	202
5,000	502
10,000	103
20,000	203
50,000	503
100,000	104
200,000	204
500,000	504
1,000,000	105

Popular values listed in boldface. Consult factory for special resistances.

Date Code Description

YY WW M

- M = COUNTRY OF MANUFACTURE (MEXICO)
- WW = WEEK NUMBER
- YY = LAST TWO DIGITS OF YEAR MANUFACTURED

How To Order

3310 Y - 0 0 1 - 103 L

Model Number Designator _____
 3310 = 9 mm Panel Control

Terminal Style Designator _____
 Single Cup:
 C = In-line Straight Terminals Side Exit 2.54 mm centers
 R = In-line Terminals Rear Exit 2.54 mm centers
 P = 5.08 mm x 2.54 mm Triangular Pattern Rear Exit
 Y = 5.08 mm x 5.08 mm Triangular Pattern Rear Exit
 Dual Cup (Pot/Pot or Pot/Switch):
 H = Dual In-line Straight Terminals Rear Exit 2.54 mm centers

Shaft End Designator _____
 0 = Shaft End Slotted
 1 = Shaft End Flatted

Shaft Length Designator _____
 0 = 12.7 mm FMS Long Plastic Shaft (Available w/bushing only)
 1 = 19.05 mm FMS Long Plastic Shaft (Available w/bushing only)
 2 = 5.59 mm FMS Long Plastic Shaft (Bushingless version only)

Bushing Designator _____
 Pot (or Pot/Pot):
 1 = 6.35 mm x 6.35 mm Plastic
 2 = 6.35 mm x 6.35 mm Ni Plated Brass
 5 = Bushingless (Board Level Control)
 Pot/Switch Bushing Designator (use with "H" terminal style only.)
 3 = 6.35 mm x 6.35 mm Plastic
 4 = 6.35 mm x 6.35 mm Ni Plated Brass
 6 = Bushingless (Board Level)

Resistance Code _____
 (1st 2 digits are significant, 3rd digit is number of 0s to follow)

RoHS Identifier _____
 L = Compliant

Specifications are subject to change without notice.

Users should verify actual device performance in their specific applications.

The products described herein and this document are subject to specific legal disclaimers as set forth on the last page of this document, and at www.bourns.com/docs/legal/disclaimer.pdf.

3310 – 9 mm Square Sealed Panel Control

BOURNS®

Product Dimensions

COMMON DIMENSIONS

3310-001

Plastic Bushing
Slotted Shaft

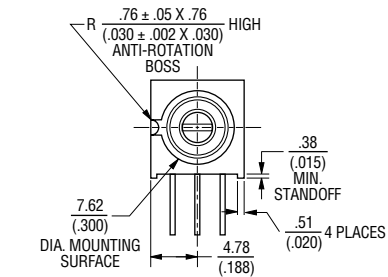
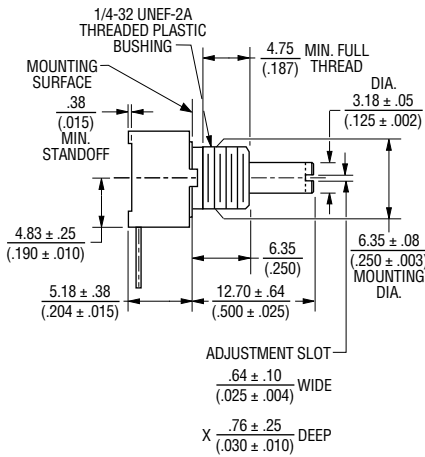
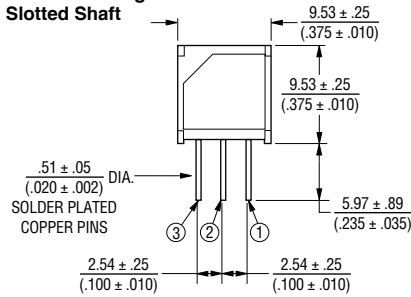

MOUNTING HOLE PATTERN

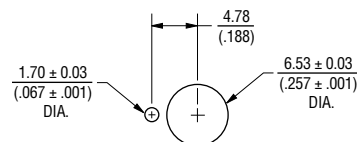

3310C-001

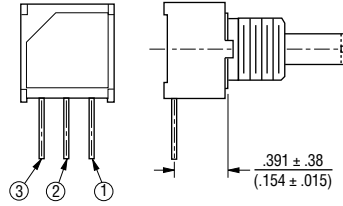

3310P-001

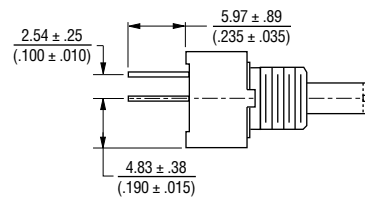
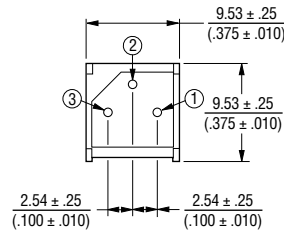

3310R-001

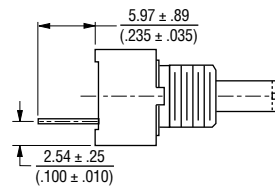
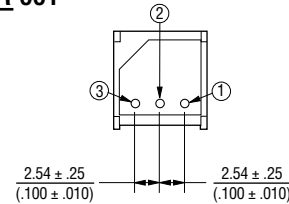

DIMENSIONS: $\frac{\text{MM}}{\text{(INCHES)}}$

3310Y-001

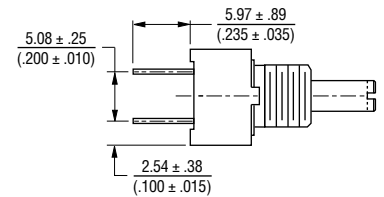
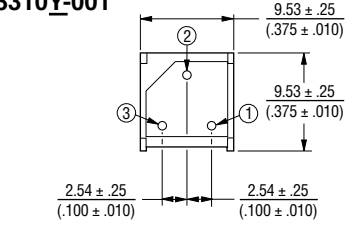

COMMON DIMENSIONS

3310C-101

Plastic Flatted Shaft

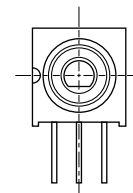
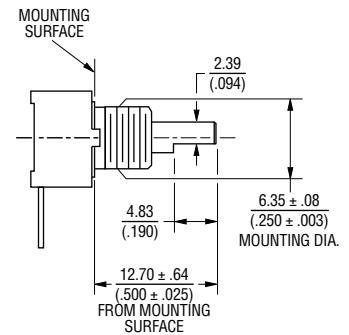

Specifications are subject to change without notice.

Users should verify actual device performance in their specific applications.

The products described herein and this document are subject to specific legal disclaimers as set forth on the last page of this document, and at www.bourns.com/docs/legal/disclaimer.pdf.

3310 – 9 mm Square Sealed Panel Control



Product Dimensions

COMMON DIMENSIONS 3310-002

Metal Bushing

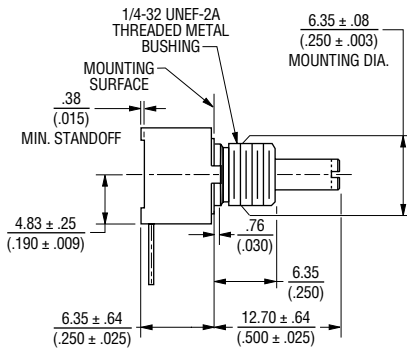

3310P-025 *

Bushingless

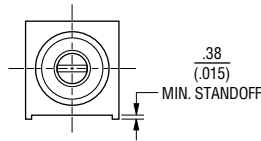
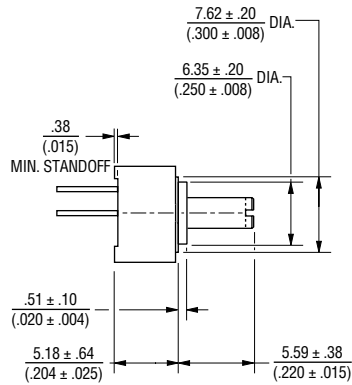

DIMENSIONS: $\frac{MM}{(INCHES)}$

3310C-002

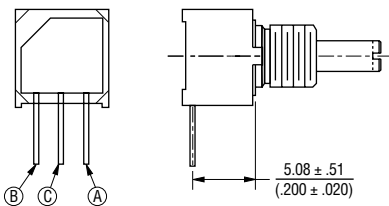

NOTE: * Only recommended shaft length for bushingless version

Hardware

LOCKWASHER H-37-5

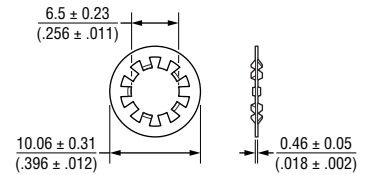

NUT H-38-1

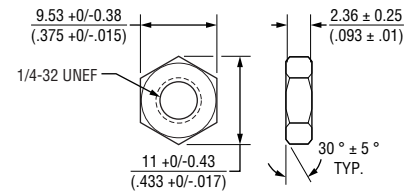

DIMENSIONS: $\frac{MM}{(INCHES)}$

Specifications are subject to change without notice.

Users should verify actual device performance in their specific applications.

The products described herein and this document are subject to specific legal disclaimers as set forth on the last page of this document, and at www.bourns.com/docs/legal/disclaimer.pdf.

3310 – 9 mm Square Sealed Panel Control



Product Dimensions

COMMON DIMENSIONS 3310H-003 Pot/Switch Dual Cup Plastic Bushing

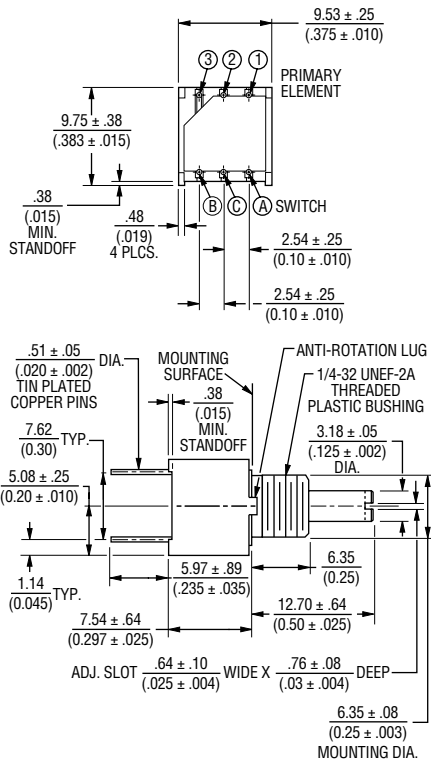

3310H-025* Pot/Pot Dual Cup Bushingless

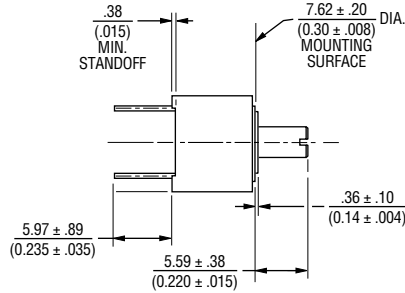
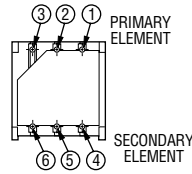

Pot/Pot Dual Cup

3310H-002 Pot/Pot Dual Cup Metal Bushing

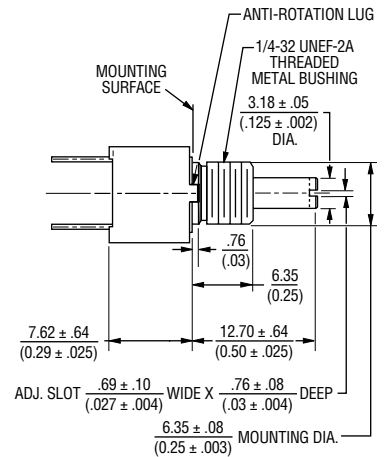
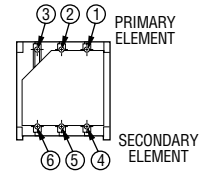

Pot/Switch Dual Cup

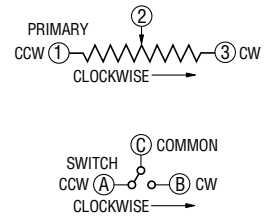
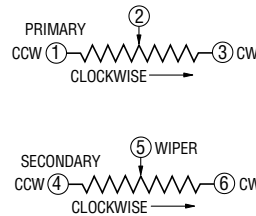

DIMENSIONS: $\frac{\text{MM}}{\text{INCHES}}$

Pot Single Cup

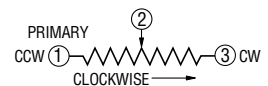

NOTE: * Only recommended shaft length for bushingless version

REV. 10/20

Specifications are subject to change without notice.

Users should verify actual device performance in their specific applications.

The products described herein and this document are subject to specific legal disclaimers as set forth on the last page of this document, and at www.bourns.com/docs/legal/disclaimer.pdf.