

Features

- Single-Turn / Cermet / Industrial / Sealed
- Miniature package
- Rotor designed for automatic machine adjust interface
- Withstands harsh environments and immersion cleaning processes
- Tape and reel packaging available

- RoHS compliant* version available
- For trimmer applications/processing guidelines, [click here](#)

3362 -1/4 " Square Trimpot® Trimming Potentiometer

Electrical Characteristics

Standard Resistance Range 10 ohms to 2 megohms
	(see standard resistance table)
Resistance Tolerance ±10 % std.
Absolute Minimum Resistance 1 % or 2 ohms
	(whichever is greater)
Contact Resistance Variation 1 % or 3 ohms max.
	(whichever is greater)
Adjustability	
Voltage Divider ±0.05 %
Rheostat ±0.15 %
Resolution Infinite
Insulation Resistance 500 vdc.
	1,000 megohms min.
Dielectric Strength	
Sea Level 900 vac
80,000 Feet 350 vac
Adjustment Angle 240 ° nom.

Environmental Characteristics

Power Rating (300 volts max.)	
70 °C 0.50 watt
125 °C 0 watt
Temperature Range -55 °C to +125 °C
Temperature Coefficient ±100 ppm/°C
Seal Test 85 °C Fluorinert†
Humidity MIL-STD-202 Method 103
	96 hours
	(2 % ΔTR; 10 Megohms IR)
Vibration 30 G (1 % ΔTR; 1 % ΔVR)
Shock 100 G (1 % ΔTR; 1 % ΔVR)
Load Life 1,000 hours 0.5 watt @ 70 °C
	(3 % ΔTR; 3 % or 3 ohms,
	whichever is greater, CRV)
Rotational Life 200 cycles
	(4 % ΔTR; 3 % or 3 ohms,
	whichever is greater, CRV)

Physical Characteristics

Mechanical Angle 270 ° nom.
Torque 3.0 oz-in. max.
Stop Strength 7.0 oz-in. min.
Terminals Solderable pins
Weight 0.02 oz.
Marking Resistance code,
	terminal numbers, manufacturer's
	model number, style
	and date code
Wiper 50 % (Actual TR) ±10 %
Flammability U.L. 94V-0
Standard Packaging 50 pcs. per tube
Adjustment Tool H-90



WARNING Cancer and Reproductive Harm

www.P65Warnings.ca.gov

Specifications are subject to change without notice. Users should verify actual device performance in their specific applications. The products described herein and this document are subject to specific legal disclaimers as set forth on the last page of this document, and at www.bourns.com/docs/legal/disclaimer.pdf.

Product Dimensions

Common Dimensions

Top Adjust

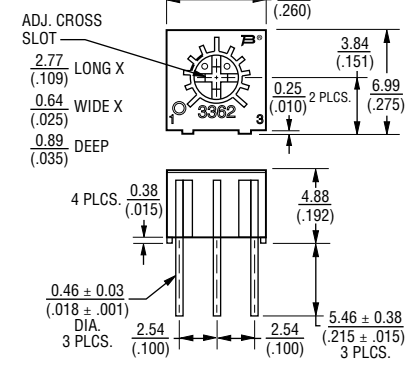

3362F

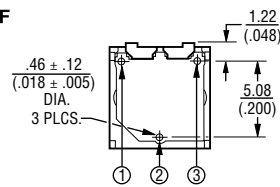

3362H

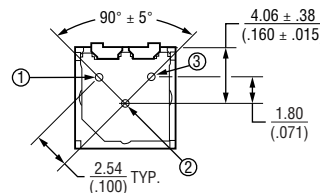

3362P

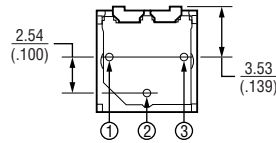

3362R

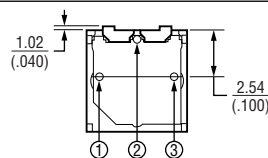

3362U

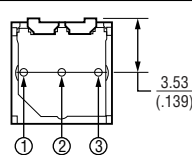

Common Dimensions

Side Adjust

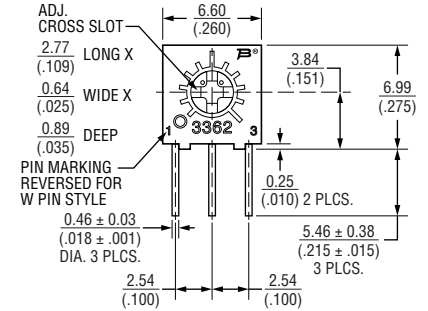

3362M

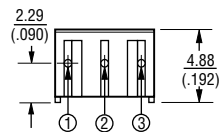

3362S

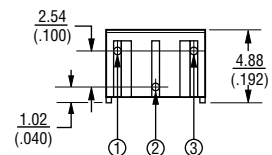

3362W

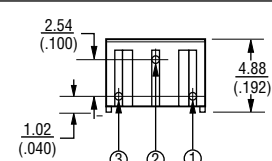

3362X

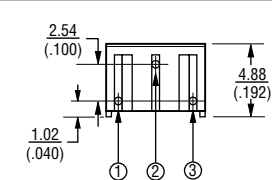

3362Z

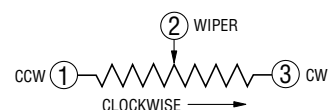
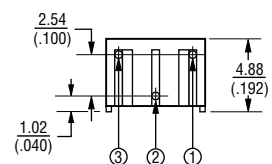

DIMENSIONS: $\frac{\text{MM}}{\text{(INCHES)}}$

TOLERANCES: $\pm \frac{0.25}{(.010)}$ EXCEPT WHERE NOTED

*RoHS Directive 2015/863, Mar. 31, 2015 and Annex
†"Fluorinert" is a registered trademark of 3M Co.
"Trimpot" is a trademark of Bourns, Inc.

3362 – 1/4 " Square Trimpot® Trimming Potentiometer

BOURNS®

Product Dimensions

Top adjust models 3362F, H, P, R and U are available with a knob for finger adjustment. Add suffix letter "T" to order code.

("P" Style shown)



DIMENSIONS: $\frac{\text{MM}}{\text{(INCHES)}}$

TOLERANCES: $\pm \frac{0.25}{(.010)}$ EXCEPT WHERE NOTED

BOURNS®

Asia-Pacific: Tel: +886-2 2562-4117

Email: asiacus@bourns.com

Europe: Tel: +36 88 885 877

Email: eurocus@bourns.com

The Americas: Tel: +1-951 781-5500

Email: americus@bourns.com

www.bourns.com

Packaging Specifications

SIDE ADJUST 3362M-1

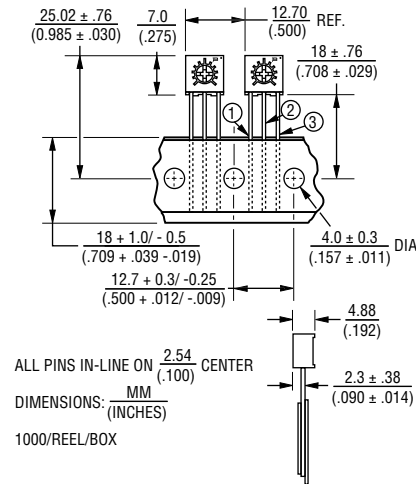

TOP ADJUST 3362U-1, 3362P-1

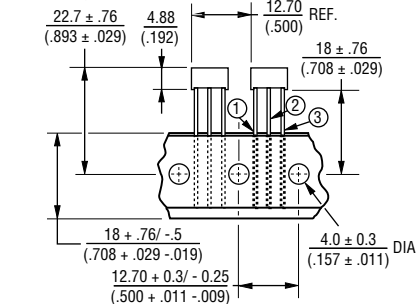

SIDE VIEW 3362U-1

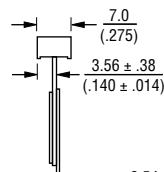

ALL PINS IN-LINE ON $\frac{2.54}{(.100)}$ CENTER
DIMENSIONS: $\frac{\text{MM}}{\text{(INCHES)}}$

Meets EIA Specification 468.

SIDE VIEW 3362P-1



750/REEL
1000/BOX

How To Order

Model **3362 P - 1 - 502 T** LF
 Style _____
 Standard or Modified Product Indicator _____
 -1 = Standard Product
 Resistance Code _____
 Optional Suffix Letter _____
 T = Knob*
 Packaging Designator _____
 Blank = Tube (Standard)
 R = Tape and Reel (M, U and P Pin Styles Only)
 A = Ammo Pack (M, U and P Pin Styles Only)
 Tape and reel material meets Antistatic ANSI/ESD 5541-2003 packaging standards.

Terminations

LF = 100 % Tin-plated (RoHS compliant)
 Blank = 90 % Tin / 10 % Lead-plated (Standard)

*Knob option is available only in standard Tube packaging for terminal styles F, H, P, R and U.

Consult factory for other available options.

Standard Resistance Table

Resistance (Ohms)	Resistance Code
10	100
20	200
50	500
100	101
200	201
500	501
1,000	102
2,000	202
5,000	502
10,000	103
20,000	203
25,000	253
50,000	503
100,000	104
200,000	204
250,000	254
500,000	504
1,000,000	105
2,000,000	205

Popular distribution resistance values listed in boldface. Special resistances available.

REV. 06/20

"Trimpot" is a registered trademark of Bourns, Inc. Specifications are subject to change without notice.

Users should verify actual device performance in their specific applications.

The products described herein and this document are subject to specific legal disclaimers as set forth on the last page of this document, and at www.bourns.com/docs/legal/disclaimer.pdf.