

THIS DOCUMENT IS THE PROPERTY OF
KEYSTONE ELECTRONICS CORP. AND
SHALL NOT BE REPRODUCED, DISTRIBUTED
OR USED AS A BASIS FOR MANUFACTURE
WITHOUT PRIOR WRITTEN PERMISSION
FROM KEYSTONE ELECTRONICS CORP.

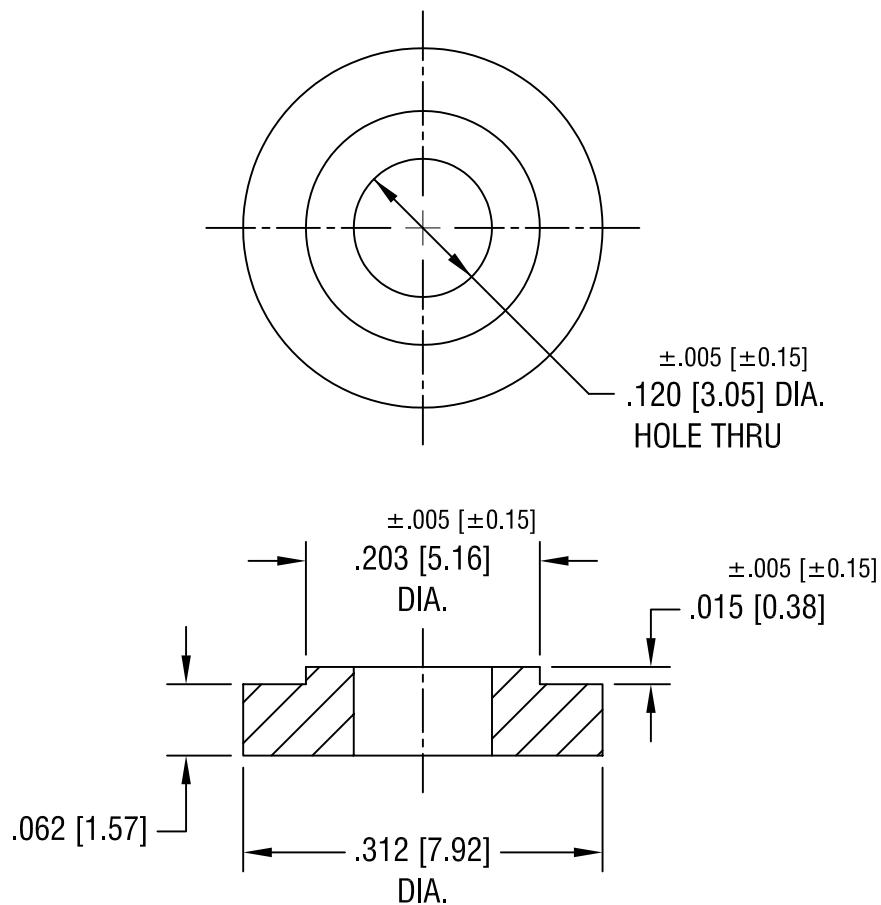

KEYSTONE ELECTRONICS CORP.

ASTORIA, N.Y. 11105-2017

PART NAME

FIBRE SHOULDER WASHER

MATERIAL

VULCANIZED FIBRE

FINISH

-

DRN BY

BOONE

DATE

2.21.01

APP'D

LN

SCALE

6X

TOLERANCES

INCH

[MM]

CODE

DWG NO.

DECIMAL

$\pm .010$ [± 0.25]

C/M

ANGULAR

$\pm 1^\circ$

UNLESS OTHERWISE SPECIFIED

344

DATE	DESCRIPTION	REV.