

## Features

- Single-turn (3851 and 3852)
- 3-3/4-turn (3856)
- Linear and audio tapers
- Wide resistance range
- Minimal depth package
- Good resolution

## 3851/3852/3856 – 3/4 " Diameter Panel Control

### Initial Electrical Characteristics<sup>1</sup>

	<b>3851 Conductive Plastic Element</b>	<b>3852/3856 Cermet Element</b>
Standard Resistance Range		
Linear Tapers (A, B, E, and H) .....	1 K to 1 megohm .....	100 ohms to 1 megohm
Audio Tapers (C, D, F, and G) .....	1 K to 1 megohm .....	1 K ohms to 1 megohm
Total Resistance Tolerance .....	±10 % or ±20 % .....	±5 % or ±10 %
Independent Linearity .....	±10 % .....	(A & H tapers) ±5 %
Absolute Minimum Resistance .....	2 ohms maximum .....	2 ohms maximum
Effective Electrical Angle .....	(Linear tapers) 250 ° ±5 ° .....	(Linear tapers) 250 ° ±5 °
	(Audio tapers) 225 ° ±5 ° .....	(Audio tapers) 225 ° ±5 °
Contact Resistance Variation .....	±1 % .....	±3 % of total resistance or 3 ohms (whichever is greater)
Dielectric Withstanding Voltage (MIL-STD-202, Method 301)		
Sea Level .....	900 VAC minimum .....	900 VAC minimum
70,000 Feet .....	350 VAC minimum .....	350 VAC minimum
Insulation Resistance (500 VDC) .....	1,000 megohms minimum .....	1,000 megohms minimum
Power Rating (Voltage Limited By Power Dissipation or 350 VAC, Whichever Is Less)		
+70 °C .....	(Linear tapers) 1 watt .....	(Linear tapers) 2 watts
	(Audio tapers) 0.5 watt .....	(Audio tapers) 1 watt
+125 °C .....	0 watt .....	
+150 °C .....		0 watt
Theoretical Resolution .....	Essentially infinite .....	Essentially infinite

### Environmental Characteristics<sup>1</sup>

Operating Temperature Range .....	-1 °C to +125 °C .....	-1 °C to +125 °C
Storage Temperature Range .....	-65 °C to +125 °C .....	-65 °C to +150 °C
Temperature Coefficient Over		
Storage Temperature Range .....	±1,000 ppm/°C .....	±150 ppm/°C
Vibration .....	20 G .....	20 G
Total Resistance Shift .....	±2 % maximum .....	±2 % maximum
Voltage Ratio Shift .....	±5 % maximum .....	±6 % maximum
Shock .....	100 G .....	100 G
Total Resistance Shift .....	±2 % maximum .....	±2 % maximum
Voltage Ratio Shift .....	±5 % maximum .....	±6 % maximum
Load Life .....	1,000 hours .....	1,000 hours
Total Resistance Shift .....	±10 % maximum .....	±3 % maximum
Rotational Life (No Load) .....	100,000 cycles .....	20,000 cycles
Total Resistance Shift .....	±15 % TRS maximum .....	±5 % or 5 ohms TRS whichever is greater
Contact Resistance Variation .....	±3 % .....	±3 %
Moisture Resistance (MIL-STD-202, Method 103, Condition B)		
Total Resistance Shift .....	±10 % maximum .....	±2 % maximum
IP Rating .....	IP 40 .....	IP 40

<sup>1</sup> Electrical specifications tested at 250 RPM, at room ambient: +25 °C nominal.



**WARNING**  
**Cancer and Reproductive Harm**  
[www.P65Warnings.ca.gov](http://www.P65Warnings.ca.gov)

\*RoHS Directive 2015/863, Mar 31, 2015 and Annex.  
 Specifications are subject to change without notice. Users should verify actual device performance in their specific applications. The products described herein and this document are subject to specific legal disclaimers as set forth on the last page of this document, and at [www.bourns.com/docs/legal/disclaimer.pdf](http://www.bourns.com/docs/legal/disclaimer.pdf).

# 3851/3852/3856 – 3/4 " Diameter Panel Control

**BOURNS®**

## Mechanical Characteristics<sup>1</sup>

Stop Strength	
3851 & 3852 .....	56.5 N-cm (5 lb.-in.)
3856 .....	Continuous turn
Mechanical Angle .....	280 ° ±5 ° / 3856 – 1350 ° ±50 °
Torque (Starting and Running).....	A & B bushings 0.35 to 4.23 N-cm (0.05 to 6.0 oz.-in.) C & E bushings 0.21 to 4.23 N-cm (0.3 to 6.0 oz.-in.) 3856 – 0.11 to 2.12 N-cm (0.15 to 3.0 oz.-in.)
Mounting (Torque on Bushing) .....	1.7-2.0 N-m (15-18 lb.-in.) maximum
Weight (Single Section) .....	30 grams maximum
Terminals .....	Printed circuit terminals or solder lugs
Soldering Condition .....	Recommended hand soldering using Sn95/Ag5 no clean solder, 0.025 " wire diameter. Maximum temperature 399 °C (750 °F) for 3 seconds. No wash process to be used with no clean flux. Part can be wave soldered at 260 °C (500 °F) for 5 seconds, no wash process with no clean flux.
Marking.....	Manufacturer's trademark, wiring diagram, resistance, date code, and part number
Ganging (Multiple Section Potentiometers).....	1 cup maximum
Hardware.....	One lockwasher and one mounting nut is shipped with each potentiometer; locking bushing versions are shipped with one additional locking nut (Bushing A&H: H-37-2 & H-38-2; Bushing B: H-37-2, H-38-2 & H-38-4; Bushing C: H-37-1 & H-38-1; Bushing E: H-37-1, H-38-1 & H-38-3)

<sup>1</sup> Electrical specifications tested at 250 RPM, at room ambient: +25 °C nominal.

Specifications are subject to change without notice.

Users should verify actual device performance in their specific applications.

The products described herein and this document are subject to specific legal disclaimers as set forth on the last page of this document, and at [www.bourns.com/docs/legal/disclaimer.pdf](http://www.bourns.com/docs/legal/disclaimer.pdf).

# 3851/3852/3856 – 3/4" Diameter Panel Control

**BOURNS®**

## Product Dimensions

### 3851A/3852A

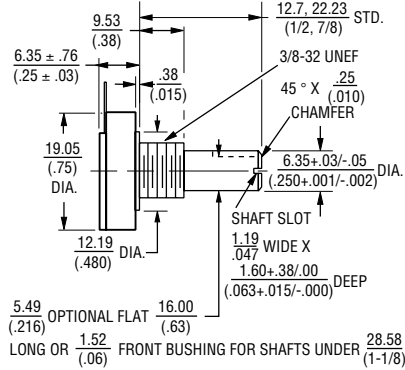

### 3851B/3852B

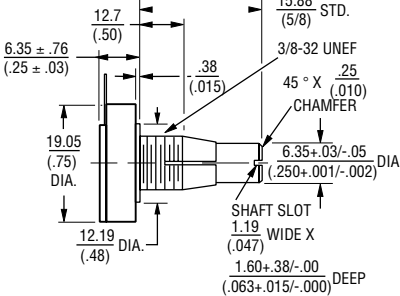

### 3851C/3852C

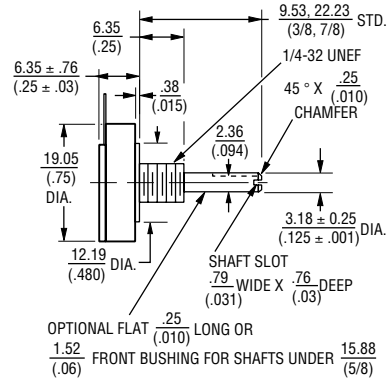

### 3851E/3852E

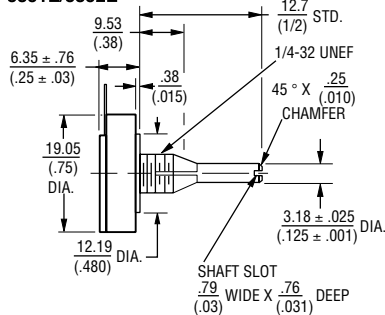

### 3856A

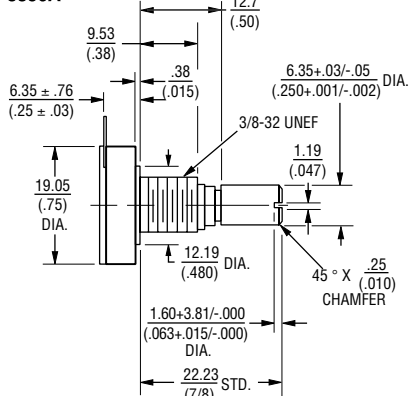

### 3856H

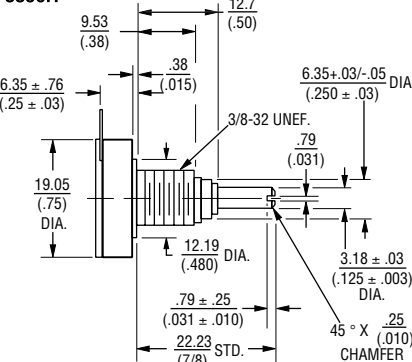

DIMENSIONS:  $\frac{\text{MM}}{\text{(INCHES)}}$

## Terminal Configuration

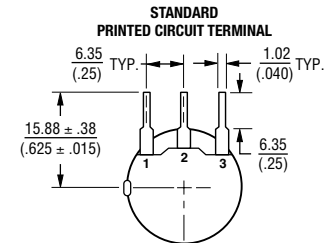
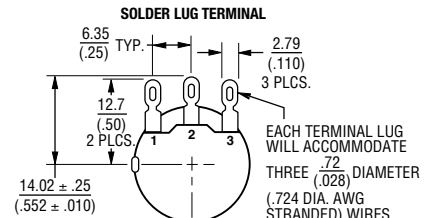

## SUGGESTED BOARD LAYOUT

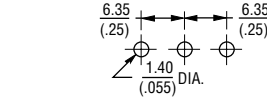

## 3851/3852/3856

### A, B & H BUSHINGS

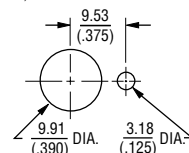

### C & E BUSHINGS

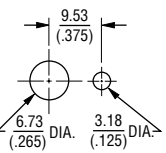

## Shaft End Detail 3850 Family

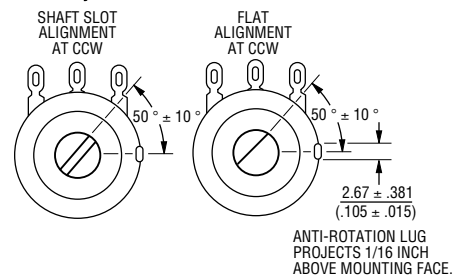

TOLERANCES EXCEPT AS NOTED:  
 DECIMALS: XXX ± .127, XX ± .38, (0.005), (.015)  
 FRACTIONS: ± 1/64  
 ANGLE: ± 3%

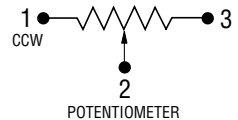

Specifications are subject to change without notice.

Users should verify actual device performance in their specific applications.

The products described herein and this document are subject to specific legal disclaimers as set forth on the last page of this document, and at [www.bourns.com/docs/legal/disclaimer.pdf](http://www.bourns.com/docs/legal/disclaimer.pdf).

# 3851/3852/3856 – 3/4 " Diameter Panel Control

**BOURNS®**

## Hardware

### LOCKWASHER H-37-1

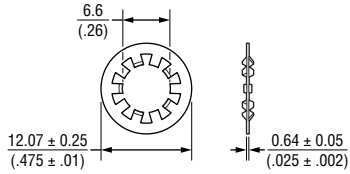

### LOCKWASHER H-37-2

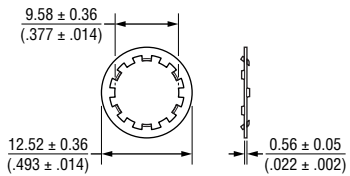

### NUT H-38-1

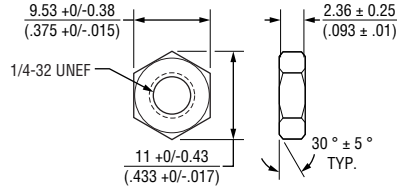

### NUT H-38-2

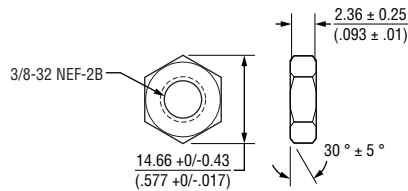

### LOCKNUT H-38-3

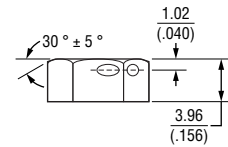
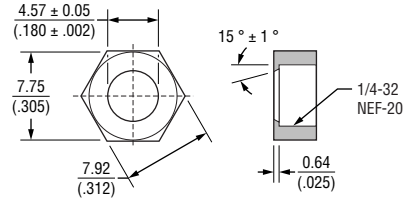

### LOCKNUT H-38-4

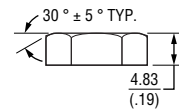
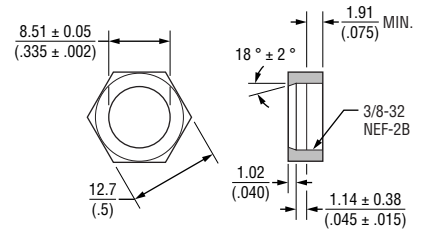

DIMENSIONS:  $\frac{\text{MM}}{\text{INCHES}}$

## Date Code Description

YY WW M

- M = COUNTRY OF MANUFACTURE (MEXICO)
- WW = WEEK NUMBER
- YY = LAST TWO DIGITS OF YEAR MANUFACTURED

Specifications are subject to change without notice.

Users should verify actual device performance in their specific applications.

The products described herein and this document are subject to specific legal disclaimers as set forth on the last page of this document, and at [www.bourns.com/docs/legal/disclaimer.pdf](http://www.bourns.com/docs/legal/disclaimer.pdf).

# 3851/3852/3856 – 3/4 " Diameter Panel Control

# BOURNS®

## How To Order

**3852 A - 28 2 - 103 A L**

SHAFT TYPE (FMS) & DIAMETER		AVAILABLE ONLY IN	
		MODELS	BUSHINGS
12	3/8 " (9.53 mm) L X 1/8 " (3.18 mm) D	3851, 3852	C
16	1/2 " (12.7 mm) L x 1/4 " (6.35 mm) D	3851, 3852	A
16	1/2 " (12.7 mm) L x 1/8 " (3.18 mm) D	3851, 3852	C, E
20	5/8 " (15.88 mm) L X 1/4 " (6.35 mm) D	3851, 3852	A, B
28	7/8 " (22.20 mm) L X 1/4 " (6.35 mm) D	3851, 3852 3856	A, B A
28	7/8 " (22.20 mm) L X 1/8 " (3.18 mm) D	3851, 3852 3856	C, E H

Consult factory for lengths not shown.

BUSHING	APPLICABLE MODELS
A Plain 3/8 " (9.53 mm) D x 3/8 " (9.53 mm) L	3851, 3852, 3856
B Locking 3/8 " (9.53 mm) D x 1/2 " (12.7 mm) L	3851, 3852
C Plain 1/4 " (6.35 mm) D x 1/4 " (6.35 mm) L	3851, 3852
E Locking 1/4 " (6.35 mm) D x 1/2 " (12.7 mm) L	3851, 3852
H Plain 3/8 " (9.53 mm) D x 3/8 " (9.53 mm) L	3856 (3.18 mm D Shaft)

RESISTANCE CODE/VALUE (IN OHMS) Model 3851	
<b>(102)</b>	<b>1 K</b>
(252)	2.5 K
<b>(502)</b>	<b>5 K</b>
<b>(103)</b>	<b>10 K</b>
(253)	25 K
<b>(503)</b>	<b>50 K</b>
<b>(104)</b>	<b>100 K</b>
(254)	250 K
(504)	500 K
(105)	1 M
Models 3852/3856	
(101)	100
(251)	250
(501)	500
<b>(102)</b>	<b>1 K</b>
<b>(252)</b>	<b>2.5 K</b>
<b>(502)</b>	<b>5 K</b>
<b>(103)</b>	<b>10 K</b>
(253)	25 K
<b>(503)</b>	<b>50 K</b>
<b>(104)</b>	<b>100 K</b>
(254)	250 K
(504)	500 K
(105)	1 M

RoHS IDENTIFIER	
L	Compliant

MODEL	
3851	3/4 " (19.05 mm) D Single-Turn C.P.
3852	3/4 " (19.05 mm) D Single-Turn Cermet
3856	3/4 " (19.05 mm) D 3-3/4-Turn Cermet

TERMINAL STYLE AND SHAFT TYPE	
1	Solder Lugs, Plain End
<b>2</b>	<b>Solder Lugs, Slotted End</b>
3	Solder Lugs, Flatted Shaft
5	PC Pins, Plain End
<b>6</b>	<b>PC Pins, Slotted End</b>
7	PC Pins, Flatted Shaft

ELEMENT TAPER/TOLERANCE		APPLICABLE MODELS
A	Linear ±10 %	3852, 3856
B	Linear ±20 %	3851
C	Audio CW ±10 %	3852, 3856
D	Audio CW ±20 %	3851
E	Linear ±10 %	3851
F	Audio CCW ±10 %	3852, 3856
G	Audio CCW ±20 %	3851
H	Linear ±5 %	3852, 3856

*Boldface features are Bourns standard options.  
All others are available with higher minimum order quantities.*

# BOURNS®

Asia-Pacific: Tel: +886-2 2562-4117 • Email: asiacus@bourns.com

EMEA: Tel: +36 88 885 877 • Email: eurocus@bourns.com

The Americas: Tel: +1-951 781-5500 • Email: americus@bourns.com

www.bourns.com

REV. 10/20

Specifications are subject to change without notice.

Users should verify actual device performance in their specific applications.

The products described herein and this document are subject to specific legal disclaimers as set forth on the last page of this document, and at [www.bourns.com/docs/legal/disclaimer.pdf](http://www.bourns.com/docs/legal/disclaimer.pdf).