

HANDLES: WITHIN YOUR GRASP

- Robust and ergonomically designed handles to suit a variety of applications
- Variety of sizes, styles, mounting positions and materials for maximum design and operational opportunities
- Maintain safety, no matter what environment



552



560



561



562



565



566



574



581



584



587



590



591



594



599



606



614



617

MORE THAN
2,100
HANDLES, KNOBS
AND POSITIONING
COMPONENTS
PRODUCTS
AVAILABLE

HANDLES, KNOBS AND POSITIONING COMPONENTS



PULL HANDLES

546



FLUSH HANDLES

561



HANDWHEELS AND KNOBS

565



CONTROL WHEELS

592



CLAMPING HANDLES

597



INDEX PLUNGERS

605



SPRING PLUNGERS

614



GRUB PINS AND RETAINING CABLES

615



LEVELS AND COLLARS

616

Bridge Handles

SR 1534

Black PA 6



Type 1



Type 2

- Impact-resistant material, yet lightweight and versatile
- Type 1 Plain Bore: for use with a socket head cap screw
- Type 1 Threaded Insert: brass threaded insert for underside attachment
- Type 1 only: Coloured caps available as separate items for aesthetic appearance or colour-coding requirements
- Type 2: Rectangular base and plain bore for use with a socket head cap screw

Plain Bore (Type 1)

Part Number	Dimensions (mm)					Thread or Bore	To fit socket head cap screw	Standard Pack Quantity
	W	H	w	h	T			
466308*	119.5	35	93.4	29	26	6.5	M6	100
466309*	145.0	40	117.0	34	29	8.5	M6	100
466310†	163.0	45	132.0	38	31	8.5	M8	100

Use with: *Small Colour Caps †Large Colour Caps

Threaded Insert (Type 1)

Part Number	Dimensions (mm)					Thread or Bore	Standard Pack Quantity
	W	H	w	h	T		
466311*	119.5	35	93.4	29	26	M6	100
466312*	145.0	40	117	34	29	M6	100
466313*	145.0	40	117.0	34	29	M8	100
466314†	163.0	45	132.0	38	31	M8	100

Use with: *Small Colour Caps †Large Colour Caps

Plain Bore (Type 2)

Part Number	Dimensions (mm)					Thread or Bore	To fit socket head cap screw	Standard Pack Quantity
	W	H	w	h	T			
086-1E	140	40	122	32	24	6.2	-	25
466315	134	41	117	35	26	8	M8	100

Small Colour Caps*

Part Number	Colour	Standard Pack Quantity
466316	Red	200
466317	Blue	200
466318	Yellow	200
466319	Black	200
466320	White	200
466321	Green	200
466322	Grey	200
466323	Orange	200

Large Colour Caps†

Part Number	Colour	Standard Pack Quantity
466324	Red	200
466325	Blue	200
466326	Yellow	200
466327	Black	200
466328	White	200
466329	Green	200
466330	Grey	200
466331	Orange	200

Colour Caps for use with Type 1 only

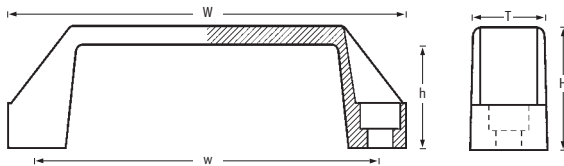

Applies to all types

Bridge Handles

SR 1534

Black Glass Filled PA 6

- Types 3-5 with female threaded brass bush

Threaded Insert (Type 3)

Part Number	Dimensions (mm)					Thread or Bore	Standard Pack Quantity
	W	H	w	h	T		
465941	132	50	117	34	25	M6	100
465942	132	50	117	34	25	M8	100

Threaded Insert (Type 4)

Part Number	Dimensions (mm)					Thread or Bore	Standard Pack Quantity
	W	H	w	h	T		
465939	156	56	132	33	34	M8	100
465940	156	56	132	33	34	M10	100

Threaded Insert (Type 5)

Part Number	Dimensions (mm)					Thread or Bore	Standard Pack Quantity
	W	H	w	h	T		
465933	137	41	120	39	28	M6	100
465934	137	41	120	39	28	M8	100



Type 3



Type 4



Type 5

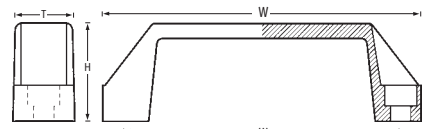

Cover Handle

SR 6409

Polyamide DIN-EN ISO 1043-1

PA 6 GRF 30

- Ideal for machinery covers
- Two different fixing type available

Part Number	Type	Standard Pack Quantity
1861	1	25
1862	2	25

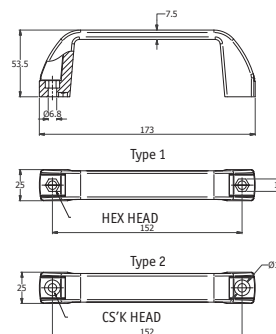

Handle

SR 6410

PA 6 and 30% glass fibre

- Industrial handle in three designs for various applications
- Easy Assembly, one standard colour black

Part Number	Dimensions (mm)					Standard Pack Quantity
	A	B	C	D	F	
109000169916	144	120	Ø4	39	F1	10
109000269916	178	160	M6	46	F2	10
109000369916	135	120	Ø4	39	F3	10

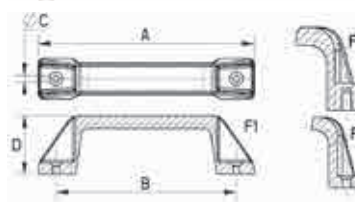

Standard Pull Handles

SR 1586

Glass-Filled Thermoplastic or Duroplast

- Economical strong handles
- Type 1, 2 and 4 with brass female threaded blind bush
- Type 3 with plain through-hole and recess for screw
- Type 4 with gloss finish

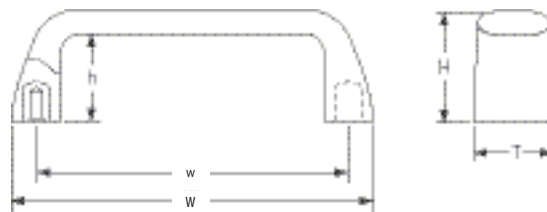

Type 1

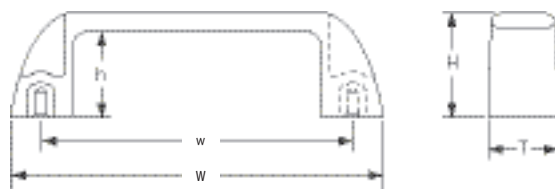

Type 2

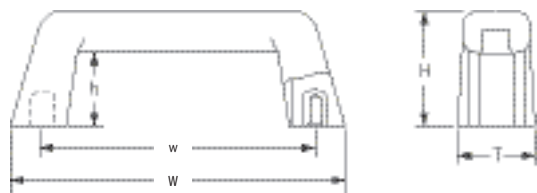

Type 4

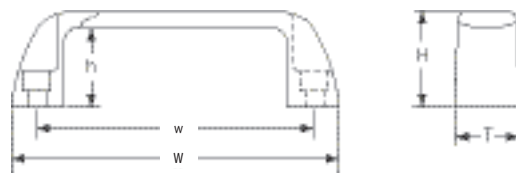

Type 3

Part Number	Type	Material	Dimensions (mm)					Thread Size	Hole Size (mm)	Standard Pack Quantity
			w	W	T	H	h			
462228	1	Thermoplastic	105.0	121	26	37	29	M5 x 9	-	100
462229	1	Thermoplastic	105.0	121	26	37	29	M6 x 9	-	100
462230	1	Thermoplastic	110.0	133	26	40	32	M5 x 9	-	100
462231	1	Thermoplastic	110.0	133	26	40	32	M6 x 9	-	100
462232	1	Thermoplastic	117.0	133	26	40	32	M5 x 9	-	100
462233	1	Thermoplastic	117.0	133	26	40	32	M6 x 9	-	100
462234	1	Thermoplastic	117.0	133	26	40	32	M8 x 9	-	100
462235	2	Thermoplastic	93.5	112	21	36	30	M6 x 9	-	100
462236	2	Thermoplastic	117.0	139	26	41	34	M8 x 9	-	100
462237	2	Thermoplastic	132.0	156	27	45	37	M6 x 9	-	100
462238	2	Thermoplastic	132.0	156	27	45	37	M8 x 9	-	100
462239	2	Thermoplastic	179.0	204	28	50	42	M8 x 9	-	100
462240	3	Thermoplastic	93.5	112	21	36	30	-	10.5	100
462241	3	Thermoplastic	117.0	139	26	41	34	-	10.5	100
462242	3	Thermoplastic	117.0	139	26	41	34	-	13.0	100
462243	3	Thermoplastic	132.0	156	27	45	37	-	10.5	100
462244	3	Thermoplastic	132.0	156	27	45	37	-	13.0	100
462245	3	Thermoplastic	179.0	204	28	50	42	-	13.0	100
462246	4	Duroplast	105.0	140	30	48	30	M6 x 13	-	100
462247	4	Duroplast	110.0	140	30	48	30	M6 x 9	-	100
462248	4	Duroplast	117.0	140	30	48	30	M8 x 15	-	100
462249	4	Duroplast	120.0	140	30	48	30	M6 x 9	-	100
462250	4	Duroplast	120.0	140	30	48	30	M8 x 9	-	100
462251	4	Duroplast	132.0	160	36	56	36	M8 x 15	-	50
462252	4	Duroplast	132.0	160	36	56	36	M10 x 16	-	50

Plastic Finger Carrying Handle

SR 5586

PA 6

- Carrying handle
- Easy and quick to install
- Supplied with screws and DIN 125 washers
- To be operated with 1, 2 or 3 fingers
- Applications include data/server racks



Type 1



Type 2

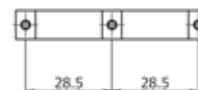
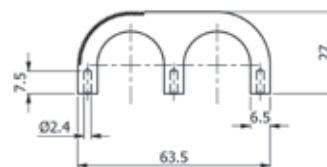
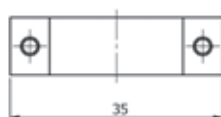
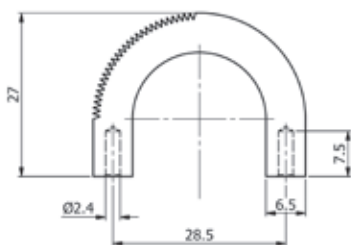

Part Number	Type	Colour	Carrying Capacity N	Standard Pack Quantity
493514	1	Grey	250	2
493515	1	Black	250	2
493516	2	Black	400	2
493517	2	Black	400	2

PULL HANDLES

Ergonomic Curved Handle

SR 5588

Black PA 66

- Ergonomic and stylish handle
- For pulling and lifting actions
- Carrying capacity 750N
- Supplied with M5 screws, washers and nuts

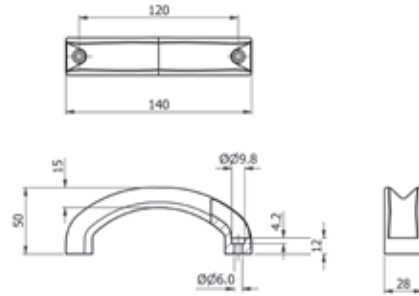

Part Number	Standard Pack Quantity
493522	2

Bow Handle – Concealed Fixing

SR 5587

Black PPN

- Ergonomic handle
- Curved shape with rounded cross section
- Front mounting with snap shut flaps to cover fixing
- Suitable for cheese head screws

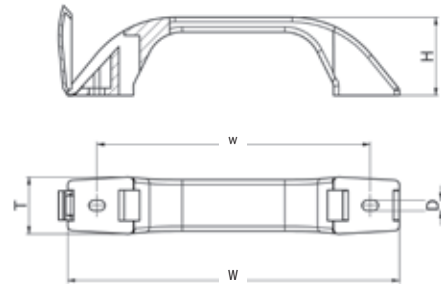

Part Number	Dimensions (mm)					Carrying Capacity N	Standard Pack Quantity
	w	W	H	T	D		
493518	66.5	83.1	19.0	13.7	3.2	50	2
493519	89.9	112.4	25.0	18.6	3.2	80	2
493520	112.0	140.0	32.0	23.2	4.2	150	2
493521	138.0	174.0	39.0	29.0	5.1	250	1

Cover Handle

SR 5581

PA 6 GFR 30

DIN-EN ISO 1043-1

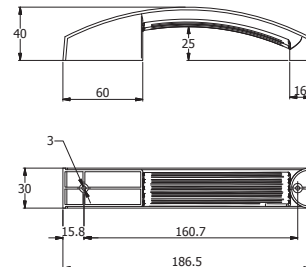

Part Number	Standard Pack Quantity
286	25

Guard Wing Handles

SR 5100

Glass fibre reinforced Polyamide (PA)

- Handles have been especially designed to fit machine guards or automation systems with single-leaf door
- Resistant to solvents, oils, greases and other chemical agents
- Handle Colour - Grey-black, matte finish
- Caps - Available only in orange for Type 1 and black and orange for Type 2. Caps made from Technopolymer in glossy finish. Supplied with the handle, press-fit assembly, removable by a screwdriver
- Type 1: Pass-through holes for cylindrical-head screws with hexagon socket, hexagonal-head screws or standard lock nuts
- Type 2: Pass-through hole for countersunk head screws

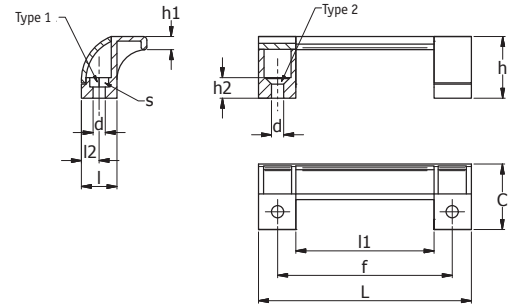

Part Number	Type	Cap Colour	Main Dimensions (mm)									Mounting Holes (mm)			Weight (grams)	Standard Pack Quantity
			L	f	h	C	l	l1	l2	h1	d	h2	s			
1218964	1	Orange	114	93.5±0.5	33	35	19	74	9.5	7	6.5	11	10	26	1	
1218965	2	Black	114	93.5±0.5	33	35	19	74	9.5	7	6.5	11	-	26	1	
1218966	2	Orange	114	93.5±0.5	33	35	19	74	9.5	7	6.5	11	-	26	1	

Angled Bridge Handle

SR 5101

Glass Filled PA

- Tilted at 15° to the vertical for easy holding

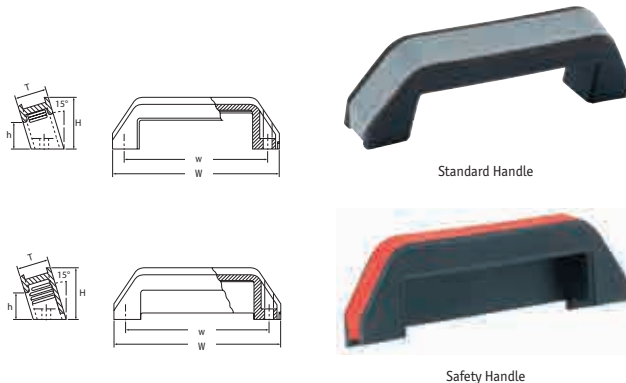

Standard Angled Bridge Handle (Plain Bore)

Part Number	Dimensions (mm)					Thread or Bore	Standard Pack Quantity
	W	H	w	h	T		
465930	126	43	108	24	24	6.5	50

Safety Angled Bridge Handle (Plain Bore)

Part Number	Dimensions (mm)					Thread or Bore	Standard Pack Quantity
	W	H	w	h	T		
465928*	126	43	108	24	24	6.5	100

*Blind on one side to stop fingers from passing through handle

Stand-Off Handles

SR 5105

Black Aluminium Grip Bar

- Modern design with ribbed grip bar

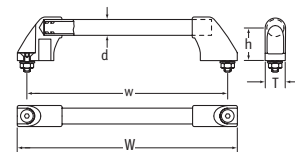

Part Number	Dimensions (mm)					Thread Size	Standard Pack Quantity
	h	d	T	W	w		
463324	42	20	26	204	180	M8 x 20	1
463325	42	20	26	224	200	M8 x 20	1
463326	42	20	26	274	250	M8 x 20	1
463327	42	20	26	324	300	M8 x 20	1
463328	42	20	26	374	350	M8 x 20	1
463329	42	20	26	424	400	M8 x 20	1
463330	42	20	26	524	500	M8 x 20	1
463331	42	20	26	624	600	M8 x 20	1

PULL HANDLES

Machine Handles

SR 5534

- Strong handle suitable for machine applications
- Type 1 & 2 can be ordered as component parts
- Type 3 & 4 – die-cast zinc alloy
- Type 1 - Polyamide with steel bar
- Type 2 - Polyamide with aluminium bar



Type 1 - Polyamide coated steel bar

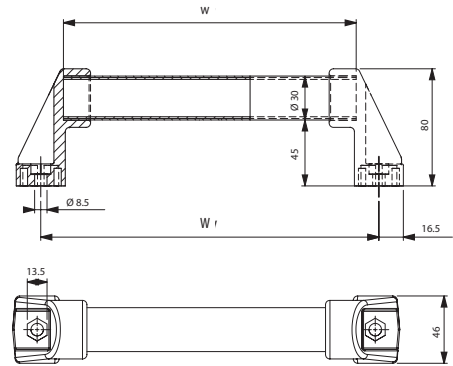

Type 1

Part Number	Dimensions (mm)		Standard Pack Quantity
	W	w	
187300E	300	269	25
187400E	400	369	30
187500E	500	469	20
187600E	600	569	20
187700E	700	669	20
187800E	800	769	10
1871000E	1000	969	10



Type 2 - Aluminium bar

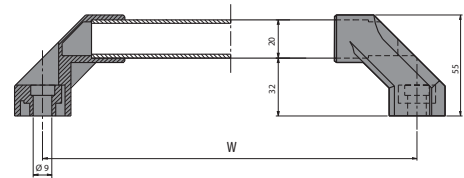

Type 2

Part Number	W (mm)	Standard Pack Quantity
087200E	200	75
087300E	300	50
087400E	400	50
087500E	500	50



Type 1: Middle Holder



Type 1/2 Handle Ends



Type 2: 1m Long Aluminium Bar



Type 1: 1m Long Steel Bar

Type 1&2 Component Parts

Part Number	W (mm)	Standard Pack Quantity
34002501E	Type 1 Middle Holder	25
35002006E	Type 1 Handle Ends	25
35002002E	Type 2 Handle Ends	50
320036001000E	Type 1: 1m Long Steel Bar	10
32006015E	Type 2: 1m Long Aluminium Bar	25

All dimensions in mm

CONTINUED ON NEXT PAGE

Machine Handles CONTINUED

SR 5534

- Strong handle suitable for machine applications
- Type 3 & 4 – die-cast zinc alloy

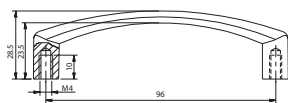

Type 3

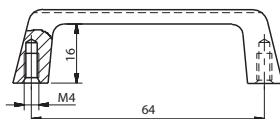

Type 4



Type 3



Type 4

Part Number	Type	Finish	Standard Pack Quantity
08411E	3	Chrome Plated	50
08412E	3	Black Powder Coated	50
08511E	4	Chrome Plated	50
08512E	4	Black Powder Coated	50

All dimensions in mm

Cover Handle

SR 5535

Fixing part: Polyamide DIN-EN ISO, 1043-1 PA 6 GFR 30

Handle: Plastic Coated Steel

- Centre supports should be used for handle lengths of 1000mm or more
- Ideal for machinery covers
- Middle holder should be used see part 35002028

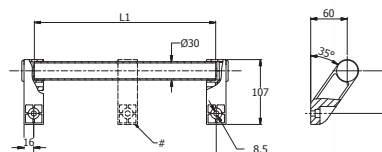

Middle part should be used for lengths greater than 1000mm



Part Number	Dimensions (mm)		Standard Pack Quantity
	L1	L	
387300	298	300	20
387400	398	400	20
387500	498	500	20
387600	598	600	20
387700	698	700	20
387800	798	800	10
3871000	998	1000	10
35002028	-	-	25

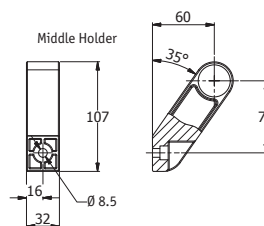

Oval Ergonomic Machine Handle

SR 5563

Polyamide with matt anodised aluminium bar

- Oval design is stylish and ergonomic

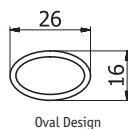
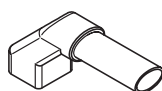

Oval Design

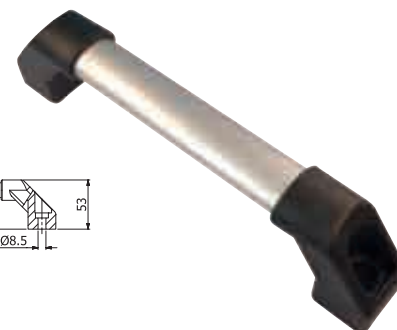
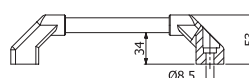
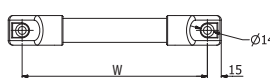

Part Number	W (mm)	Standard Pack Quantity
287200E	200	50
287300E	300	50
287400E	400	50
287500E	500	50

Aluminium Handles

SR 5102

Aluminium



Type 1

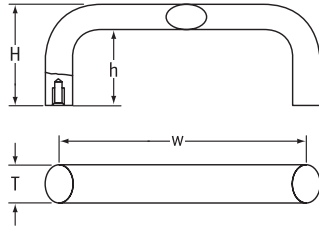

Type 1

Part Number	Colour	Dimensions (mm)				Thread Size	Standard Pack Quantity
		H	h	T	w		
463283	Black	50	37	20	100	M6 x 12	10
463284	Black	50	37	20	112	M6 x 12	10
463286	Black	50	37	20	120	M6 x 12	10
463287	Black	55	38	26	120	M8 x 14	10
463288	Black	50	37	20	128	M6 x 12	10
463289	Black	55	38	26	128	M8 x 14	10
463290	Black	50	37	20	160	M6 x 12	10
463291	Black	55	38	26	160	M8 x 14	10
463292	Black	55	38	26	180	M8 x 14	10
463293	Black	55	38	26	192	M8 x 14	10
463294	Black	55	38	26	350	M8 x 14	10



Type 2

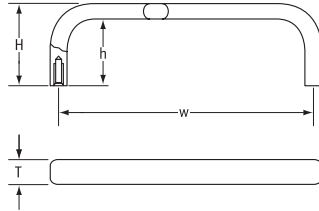

Type 2

Part Number	Colour	Dimensions (mm)				Thread Size	Standard Pack Quantity
		H	h	T	w		
491379	Silver	41	33	12	55	M5	10
491380	Silver	41	33	12	88	M5	10
491381	Silver	41	33	12	100	M5	10
491382	Silver	41	33	12	120	M5	10
491383	Silver	41	33	12	180	M5	5
491384	Silver	41	33	12	235	M5	5
463295	Black	40	32	12	55	M5 x 10	10
463296	Black	40	32	12	88	M5 x 10	10
463297	Black	40	32	12	100	M5 x 10	10
463298	Black	40	32	12	120	M5 x 10	10
463300	Black	40	32	12	200	M5 x 10	10
463302	Black	40	32	12	250	M5 x 10	10



Type 3

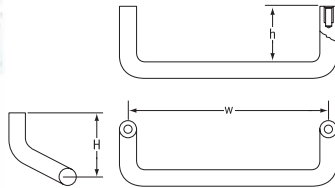

Type 3

Part Number	Colour	Dimensions (mm)				Thread Size	Standard Pack Quantity
		H	h	T	w		
463305	Black	40	30	-	86	M5 x 10	10
463306	Black	40	30	-	120	M5 x 10	10
463307	Black	40	30	-	180	M5 x 10	10



Type 4



Type 4

Part Number	Colour	Dimensions (mm)				Thread Size	Standard Pack Quantity
		H	h	T	w		
491385	Silver	32	25	10.5	100	M6	10
491386	Silver	50	40	14.5	125	M6	10

Aluminium Curved Handle

SR 6505

- Plastic End Bracket – Reinforced polyamide. Oils and grease resistant
- Tube – Painted with Black epoxy powder. Silver in colour RAL 9006 or Marble black code 01
- Hole – Smooth throughout

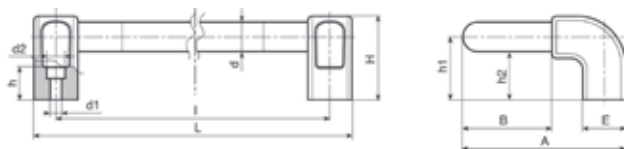

Part Number	Colour	Dimensions (mm)												Standard Pack Quantity
		l	L	d	d2	A	B	E	H	h	h1	h2	D1	
1340310	Silver	200	230	20	14.5	110.5	60.5	29	57	19.5	42.5	32.5	8.5	5
1340311	Black	200	230	20	14.5	110.5	60.5	29	57	19.5	42.5	32.5	8.5	5
1340312	Silver	300	330	20	14.5	110.5	60.5	29	57	19.5	42.5	32.5	8.5	5
1340313	Black	300	330	20	14.5	110.5	60.5	29	57	19.5	42.5	32.5	8.5	5

Bridge Handle with Vertical Ends

SR 6506

- Anodised Aluminium alloy 6060 tube
- Winged snap-fit LDPE tube cap
- This handle is supplied unassembled

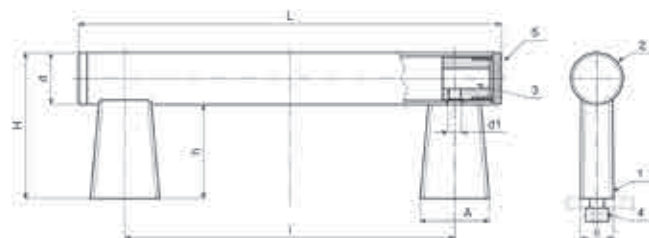

Part Number	Colour	Dimensions (mm)								Standard Pack Quantity
		l	L	D	H	h	A	B	d1	
1340314	Silver	200	256	30	85	55	40	19	M8	5
1340315	Silver	250	306	30	85	55	40	19	M8	5
1340316	Silver	300	356	30	85	55	40	19	M8	5
1340317	Silver	350	406	30	85	55	40	19	M8	5
1340318	Silver	400	456	30	85	55	40	19	M8	5
1340319	Silver	600	656	30	85	55	40	19	M8	5
1340320	Black	200	256	30	85	55	40	19	M8	5
1340321	Black	250	306	30	85	55	40	19	M8	5
1340322	Black	300	356	30	85	55	40	19	M8	5
1340323	Black	350	406	30	85	55	40	19	M8	5
1340324	Black	400	456	30	85	55	40	19	M8	5
1340325	Black	600	656	30	85	55	40	19	M8	5

PULL HANDLES

Cabinet "U" Handle Back Mount

SR 6507

Aluminium

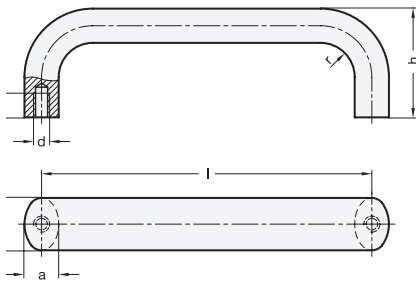

- Handles are made from a bent aluminium profile and have excellent stability and ergonomic design. Due to the production process, special designs can be supplied
- Coated with a highly weather-resistant and UV-protective powder coating system, making this version excellent for outdoor use
- Handle colour - Black, RAL 9005, textured finish
- Standard elements with antimicrobial plastic coating are primarily used in the health care sector and in public buildings, such as airports, railway stations, stadiums, etc.
- Available in a front and back mount

Part Number	Dimensions							Standard Pack Quantity
	Width	length l ± 0.25	a	d	h	r	Thread Height	
1337626	20	100	13	M6	49	13	10	2
1337627	20	112	13	M6	49	13	10	2
1337628	20	117	13	M6	49	13	10	2
1337629	20	120	13	M6	49	13	10	2
1337630	20	128	13	M6	51	13	10	2
1337631	20	160	13	M6	51	13	10	2
1337632	20	180	13	M6	51	13	10	2
1337633	20	200	13	M6	51	13	10	2
1337634	20	235	13	M6	51	13	10	2
1337635	26	112	17	M8	49	17	12	2
1337636	26	117	17	M8	49	17	12	2
1337637	26	120	17	M8	49	17	12	2
1337638	26	125	17	M8	51	17	12	2
1337639	26	128	17	M8	51	17	12	2
1337640	26	160	17	M8	57	17	12	2
1337641	26	179	17	M8	57	17	12	2
1337642	26	192	17	M8	57	17	12	2
1337643	26	300	17	M8	57	17	12	2
1337644	26	400	17	M8	57	17	12	2
1337645	26	50	17	M8	57	17	12	2

Cabinet "U" Handle Front Mount

SR 6508

Aluminium

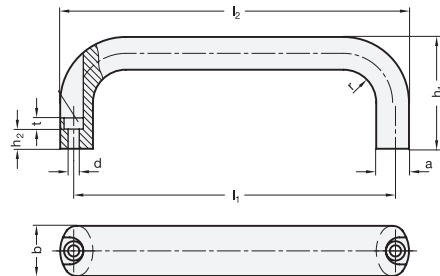

Part Number	Dimensions									Standard Pack Quantity
	b	length l ± 0.25	a	d	h1	h2	l2	r	t	
1337646	20	100	13	5.4	49	13.5	112	13	5.5	2
1337647	20	112	13	5.4	49	13.5	124	13	5.5	2
1337648	20	120	13	5.4	49	13.5	132	13	5.5	2
1337649	20	128	13	5.4	51	13.5	140	13	5.5	2
1337650	20	160	13	5.4	51	13.5	172	13	5.5	2
1337651	26	116	17	6.4	55	11	130	17	6	2
1337652	26	120	17	6.4	55	11	134	17	6	2
1337653	26	132	17	6.4	55	11	146	17	6	2
1337654	26	164	17	6.4	57	11	178	17	6	2
1337655	26	179	17	6.4	57	11	193	17	6	2
1337656	26	196	17	6.4	57	11	210	17	6	2

Inclined Cabinet "U" Handles

SR 6509

Aluminium

- Inclined cabinet "U" Handles are produced from profiled aluminium extrusions
- Black powder coated finish
- Type 1: Mounting from the back (threaded blind bore)
- Type 2: Mounting from the operators side

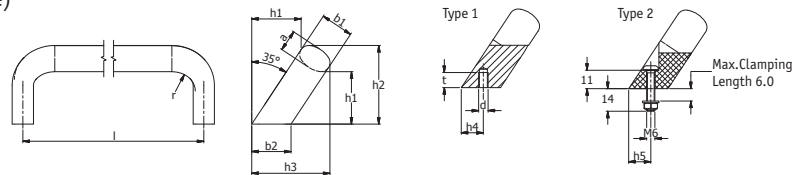

Part Number	Type	Mounting	Dimensions (mm)											Standard Pack Quantity	
			b1	Length l ±0.25	a	b2	d	h1	h2	h3	h4+1	h5+1	r		t (min.)
1220487	1	From the Back	20	112	13	24	M6	32	48	50	13.5	-	13	10	2
1220488	1	From the Back	20	128	13	24	M6	32	48	50	13.5	-	13	10	2
1220489	1	From the Back	26	128	17	32	M8	34	54	57	18	-	17	12	2
1220490	2	From Operator Side	26	128	17	32	M8	34	54	57	18	13	17	-	2
1220491	1	From the Back	26	160	17	32	M8	34	54	57	18	-	17	12	2
1220492	2	From Operator Side	26	160	17	32	M8	34	54	57	18	13	17	-	2

Stainless Steel Cabinet "U" Handles

SR 6510

AISI 303 Stainless Steel with a matt shot-blasted finish

- Location discs included

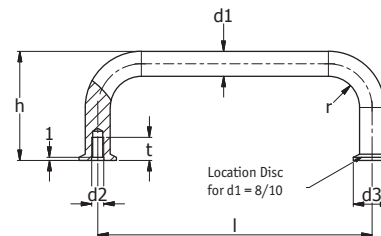
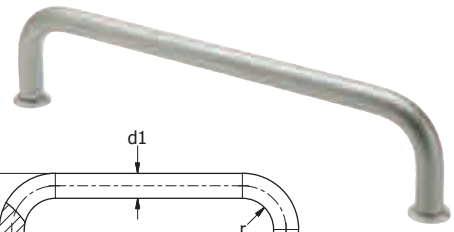

Part Number	Dimensions (mm)							Standard Pack Quantity
	d1	Length l ±0.25	d2	d3	h	r	t (min.)	
1220496	8	64	M4	12	35	10	8	2
1220497	8	88	M4	12	35	10	8	2
1220498	8	96	M4	12	35	10	8	2
1220493	8	100	M4	12	35	10	8	2
1220494	8	120	M4	12	35	10	8	2
1220495	8	128	M4	12	35	10	8	2

Stainless Steel Cabinet "U" Handles

SR 6511

- Type 1: Mounting from the back (threaded blind bore). Made from Stainless Steel AISI 304
- Type 2: Mounting from the operator's side Made from AISI CF-8 stainless steel, fine die casting, shot-blasted

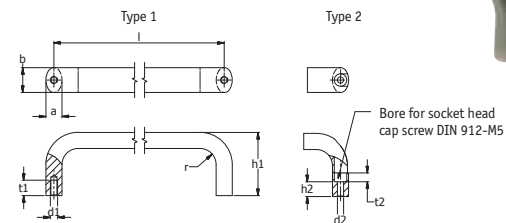
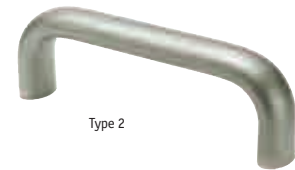

Part Number	Type	Mounting	Dimensions (mm)										Standard Pack Quantity
			b	Length l ±0.25	a	d1	d2	h1	h2	r	t1 (min.)	t2	
1220499	1	From the Back	20	112	13	M6	5.4	49	13.5	13	10	-	2
1220500	2	From Operator Side	20	112	13	M6	5.4	49	13.5	13	-	5.5	2
1220501	1	From the Back	20	128	13	M6	5.4	51	13.5	13	10	-	2
1220502	2	From Operator Side	20	128	13	M6	5.4	51	13.5	13	-	5.5	2
1220503	1	From the Back	20	160	13	M6	5.4	51	13.5	13	10	-	2
1220504	2	From Operator Side	20	160	13	M6	5.4	51	13.5	13	-	5.5	2

PULL HANDLES

Steel Pull Handles

SR 5112

Chrome Plated Steel

Insert Material: Steel

- Each handle comes complete with nickel-plated dress ring, screws and washers

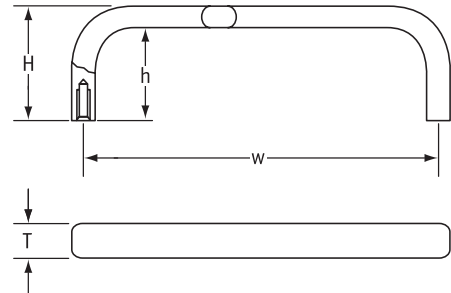

Part Number	Dimensions (mm)				Thread Size	Standard Pack Quantity
	H	h	T	W		
491388	24	19	5	88	M3	10
491389	33	25	8	88	M4	10
491390	33	25	8	96	M4	10
491391	33	25	8	120	M4	10
491392	41	31	10	120	M5	10
491393	41	31	10	180	M5	5
491394	41	31	10	235	M5	5

Hinged Handles

SR 5103

Black Glass-Filled PA or Mild Steel with Plastic Grip

- Type 1: Heavy-duty spring-loaded handle, returns to 'flat' position automatically
- Type 2: Spring arrestment in extended and flush positions

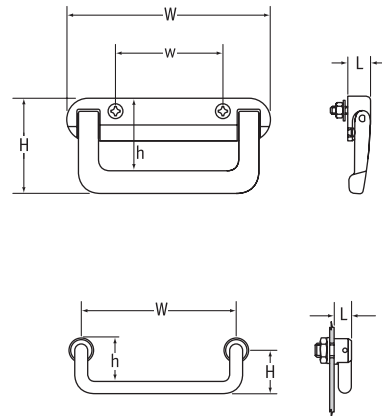
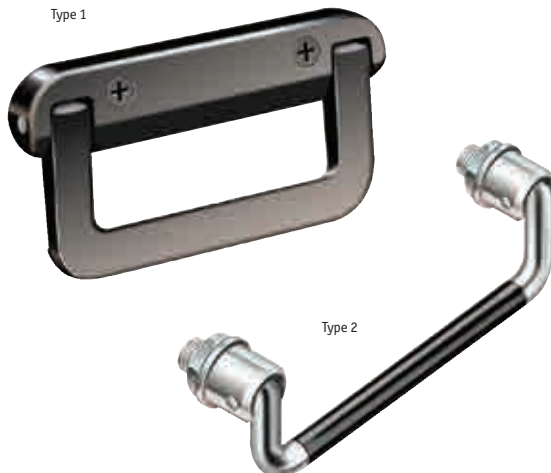

Part Number	Type	Dimensions (mm)					Thread Size	Standard Pack Quantity
		H	h	W	w	L		
463397	1	77	59	154	80	18	M6 x 30	1
463398	2	34	24	100	-	14	M10 x 14	2
463399	2	34	24	120	-	14	M10 x 14	2
463400	2	34	24	180	-	14	M10 x 14	2

Premium Stainless Steel Handles

SR 5104

Semi-Matt Stainless Steel

- High corrosive and chemical resistance
- Blind female thread. Supplied complete with high-grade stainless steel hex head setscrews and washers
- Other mounting options available on request

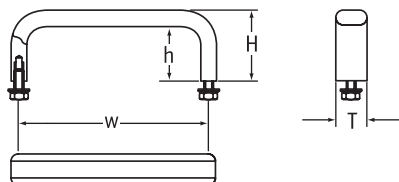

Part Number	Dimensions (mm)				Thread Size	Standard Pack Quantity
	H	h	T	W		
491388	24	19	5	88	M3	10
491389	33	25	8	88	M4	10
491390	33	25	8	96	M4	10
491391	33	25	8	120	M4	10
491392	41	31	10	120	M5	10
491393	41	31	10	180	M5	5
491394	41	31	10	235	M5	5

Standard Stainless Steel Handles

SR 5101

Electro Polished Stainless Steel

- Lightweight large handles

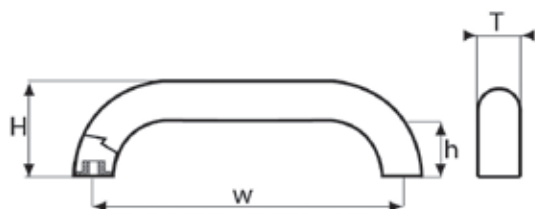

Part Number	Dimensions (mm)				Thread Size	Standard Pack Quantity
	H	h	T	W		
491377	59.0	35.0	25.0	195.0	M6	2
491378	75.0	50.0	25.0	300.0	M6	2

PULL HANDLES

Tubular Handles

SR 6512

- Ideal for double-winged doors
- Type 1: Mounting from the back (threaded blind bore)
- Type 2: Mounting from the operators side
- Three finishes available:
- Finish 1: Tube: anodized, natural colour
Handle shanks: Black powder coated, RAL 9005, textured finish
- Finish 2: Tube: Black powder coated, RAL 9005, textured finish
Handle shanks: Black powder coated, RAL 9005, textured finish
- Finish 3: Tube: anodized, natural colour.
Handle shanks: Silver powder coated, RAL 9006, textured finish

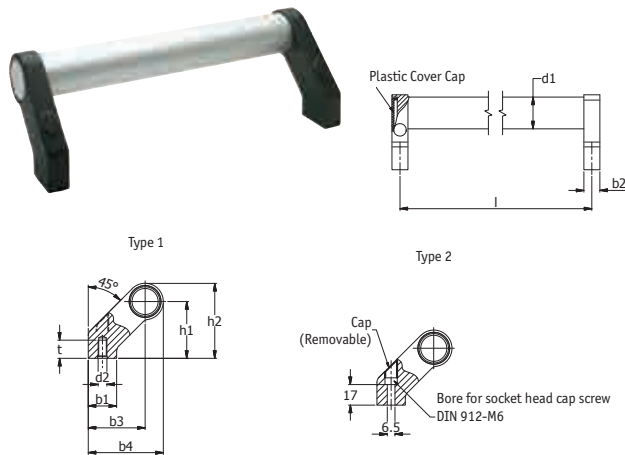

Ledge Handles

SR 6513

- Ideal for swivel or sliding doors and for use as drawer handles
- Type 1: Without lettering block
- Type 2: With lettering block
- End caps are made from Black Polyamide (PA)
- Mount using screw channel for M6 screws
- Two finishes available:
- Finish 1: Plastic coated aluminium, black, RAL 9005, textured finish
- Finish 2: Anodized aluminium, natural colour

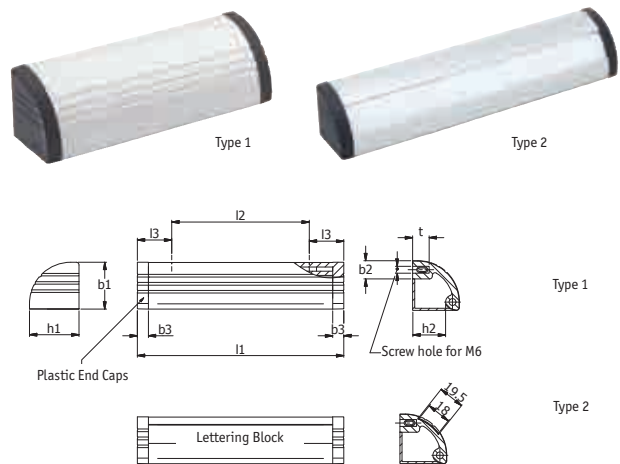

Part Number	Type	Finish	Dimensions (mm)											Standard Pack Quantity
			d1	Length L±0.25	d2	b1	b2	b3	b4	h1	h2	t	(min.)	
1220505	1	1	28	200	M8	25	14	50	66	50	66	15	1	
1220506	1	2	28	200	M8	25	14	50	66	50	66	15	1	
1220507	2	1	28	200	M8	25	14	50	66	50	66	15	1	
1220508	2	2	28	200	M8	25	14	50	66	50	66	15	1	
1220509	1	1	28	250	M8	25	14	50	66	50	66	15	1	
1220510	1	2	28	250	M8	25	14	50	66	50	66	15	1	
1220511	2	1	28	250	M8	25	14	50	66	50	66	15	1	
1220512	2	2	28	250	M8	25	14	50	66	50	66	15	1	
1220513	1	1	28	300	M8	25	14	50	66	50	66	15	1	
1220514	1	2	28	300	M8	25	14	50	66	50	66	15	1	
1220515	2	1	28	300	M8	25	14	50	66	50	66	15	1	
1220516	2	2	28	300	M8	25	14	50	66	50	66	15	1	
1220517	1	1	28	350	M8	25	14	50	66	50	66	15	1	
1220518	1	3	28	350	M8	25	14	50	66	50	66	15	1	
1220519	1	2	28	350	M8	25	14	50	66	50	66	15	1	
1220520	2	1	28	350	M8	25	14	50	66	50	66	15	1	
1220521	2	2	28	350	M8	25	14	50	66	50	66	15	1	
1220522	1	1	28	400	M8	25	14	50	66	50	66	15	1	
1220523	1	2	28	400	M8	25	14	50	66	50	66	15	1	
1220524	2	1	28	400	M8	25	14	50	66	50	66	15	1	
1220525	2	2	28	400	M8	25	14	50	66	50	66	15	1	
1220526	1	1	28	500	M8	25	14	50	66	50	66	15	1	
1220527	1	2	28	500	M8	25	14	50	66	50	66	15	1	
1220528	2	1	28	500	M8	25	14	50	66	50	66	15	1	
1220529	2	2	28	500	M8	25	14	50	66	50	66	15	1	

Part Number	Type	Finish	Dimensions (mm)										Standard Pack Quantity
			l1	b1	b2	b3	h1	h2	L2 Screw Area	l3	t		
1220530	1	2	110	36	13	8	34	24	66	22	12	2	
1220531	1	1	110	36	13	8	34	24	66	22	12	2	
1220532	1	2	150	36	13	8	34	24	106	22	12	2	
1220533	1	1	150	36	13	8	34	24	106	22	12	2	
1220534	1	2	200	36	13	8	34	24	156	22	12	2	
1220535	1	1	200	36	13	8	34	24	156	22	12	2	
1220536	1	2	250	36	13	8	34	24	206	22	12	2	
1220537	1	1	250	36	13	8	34	24	206	22	12	2	
1220538	1	2	300	36	13	8	34	24	256	22	12	2	
1220539	1	1	300	36	13	8	34	24	256	22	12	2	
1220540	1	2	400	36	13	8	34	24	356	22	12	2	
1220541	1	1	400	36	13	8	34	24	356	22	12	2	
1220542	1	2	500	36	13	8	34	24	456	22	12	2	
1220543	1	1	500	36	13	8	34	24	456	22	12	2	
1220544	2	2	110	36	13	8	34	24	66	22	12	2	
1220545	2	1	110	36	13	8	34	24	66	22	12	2	
1220546	2	2	150	36	13	8	34	24	106	22	12	2	
1220547	2	1	150	36	13	8	34	24	106	22	12	2	
1220548	2	2	200	36	13	8	34	24	156	22	12	2	
1220549	2	1	200	36	13	8	34	24	156	22	12	2	
1220550	2	2	250	36	13	8	34	24	206	22	12	2	
1220551	2	1	250	36	13	8	34	24	206	22	12	2	
1220552	2	2	300	36	13	8	34	24	256	22	12	2	
1220553	2	1	300	36	13	8	34	24	256	22	12	2	
1220554	2	2	400	36	13	8	34	24	356	22	12	2	
1220555	2	1	400	36	13	8	34	24	356	22	12	2	
1220556	2	2	500	36	13	8	34	24	456	22	12	2	
1220557	2	1	500	36	13	8	34	24	456	22	12	2	

Spring Loaded Hinged Handle

SR 5436

Chrome Plated Steel

- Spring Loaded
- Rubber bumper on handle
- Excellent for pulling or lifting



Part Number	Dimensions (mm)			Standard Pack Quantity
	Upper	Side	Handle	
493604	133	82	98	5

Hinged Recessed Handles

SR 5109

Black Aluminium

- Type 1 snap-lock in both rest and work positions
- Type 2 with pull-back spring handle
- To suit M4 countersunk screws (not supplied)

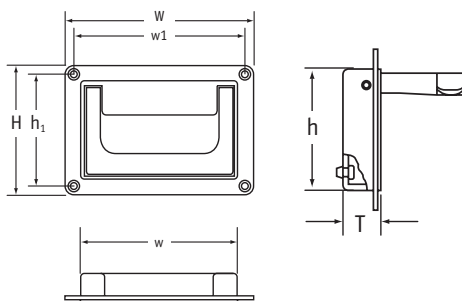

Types 1 and 2



Part Number	Type	Dimensions (mm)							Mounting Cut-out Size (mm)	Standard Pack Quantity
		H	h	h1	W	w	w1	T		
463470	1	91	69	79	130	109	118	20.5	70.5 x 110	1
463471	1	80	50	50	200	170	184	20.5	73.0 x 171	1
463478	2	91	69	79	130	109	118	20.5	70.5 x 110	1
463479	2	80	50	50	200	170	184	20.5	73.0 x 171	1

FLUSH HANDLES

Screw on Flush Handles

SR 5573

Polyamide



- Strong handle
- Fixed using M6 screws (not supplied)
- Can be mounted horizontally or vertically



Part Number	Dimensions (mm)			Standard Pack Quantity
	W	H	D	
1287197	133	60	22	50

Ergonomic Screw on Flush Handle

SR 5575

Black or Grey ABS



- Deep grip handle
- Carrying capacity 500N/Pair
- Compact and ergonomic design
- M3 fixing offers simple and secure installation

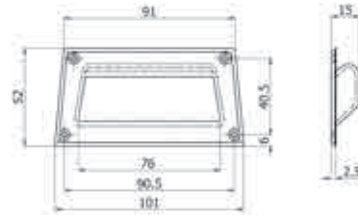

Part Number	Colour	Standard Pack Quantity
493457	Grey RAL 7001	2
493458	Black	2

Flush Pull Handles Snap-In Assembly

SR 6514

Glass-fibre reinforced polyamide based (PA) technopolymer

- The compact shape of the cavity offers a safe, comfortable and ergonomic grip
- Colour – Grey-black colour, matte finish.

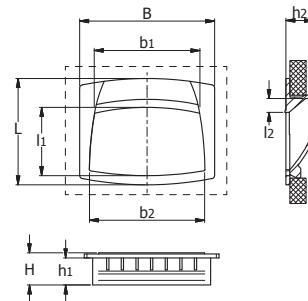

Part Number	Dimensions (mm)									Weight (Grams)	Standard Pack Quantity
	B	L	H	h1	h2	b1	b2	l1	l2		
1218969	90	50	19	17	17.5	76	79	28	7	20	5
1218967	109	73	24	20	21.5	91	96	42	9	45	5
1218968	120	95	28.5	24	26.5	94	103	58	11	58	5

Snap Fit Recessed Pull Handle

SR 5576

Black or grey ABS

- Deep grip handle
- Carrying capacity 750N/Pair
- Compact and ergonomic design
- Installed by pushing handle into mounting hole
- Type 2 & 3 include spring clips for mounting on the internal wall

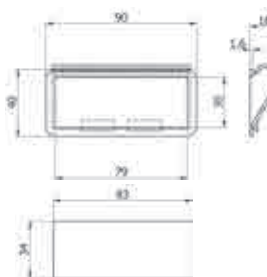

Type 1

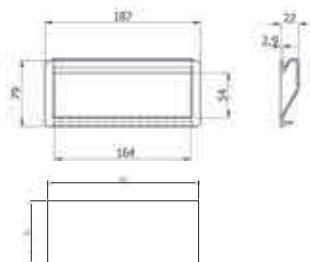

Type 3

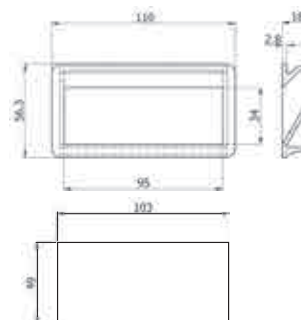

Type 2

Part Number	Colour	Type	Mounting Hole (mm)	Panel Thickness	Standard Pack Quantity
493459	Black	1	83 x 34	0.75 - 1.5 mm	1
493460	Grey	1	83 x 34	0.75 - 1.5 mm	1
493461	Black	2	103 x 49	0.75 - 1.5 mm	1
493462	Grey	2	103 x 49	0.75 - 1.5 mm	1
493463	Black	3	171 x 73	1.5 - 2.0 mm	1

Low Profile Flush Pull Handle

SR 5466

Black ABS UL94 HB

- Snap-in installation
- To suit 1-2.5mm panel thickness

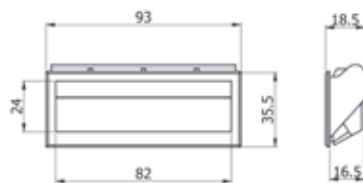

Type 1

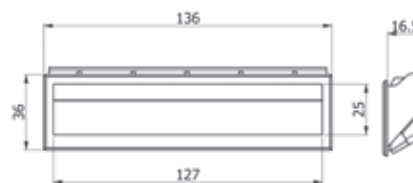

Type 2



Door Cut-Out

Part Number	Type	Dimensions W (mm)	Standard Pack Quantity
1239055	1	87.5	20
1239056	2	132	20

FLUSH HANDLES

Cover Pull (Snap-in)

SR 6515

PA 6 – Black

- Ideal for machinery covers
- Easy assembly by clips
- Flush design

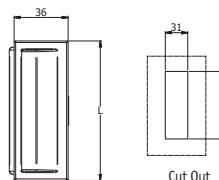

Part Number	Dimensions (mm)			Standard Pack Quantity
	Panel Thickness	L	l1	
274115	0.8 - 1.4	93.0	87.5	50
274122	1.5 - 2.2	93.0	87.5	50
274215	0.8 - 1.4	136.0	132.0	50
274222	1.5 - 2.2	136.0	132.0	50

Stainless Steel Bolt on Flush Handle

SR 5577

Stainless Steel 304



- Satin Finish
- Secured with washers and nuts (supplied)
- Type 2 corners are bevelled for easy cleaning



Type 1



Type 2

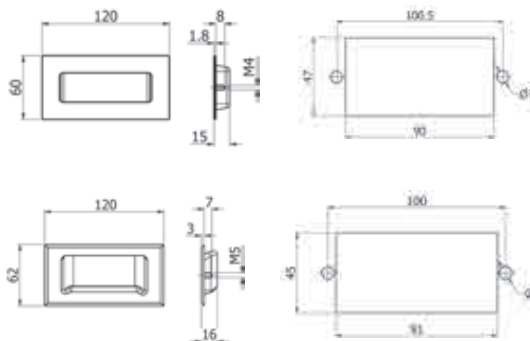

Part Number	Colour	Standard Pack Quantity
493464	1	50
493465	2	50

Palm Handle

SR 6408

Glass fibre

Reinforced polyamide based technopolymer

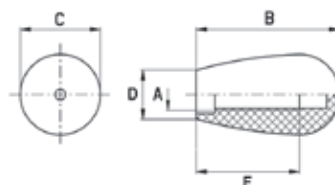

Black glossy finish

Part Number	Dimensions (mm)					Standard Pack Quantity
	A	B	C	D	E	
262062559901	M6	25	16	12	16	10
262083059901	M8	32	20	14	20	10
262084059901	M8	42	26	17	30	10
262105559901	M10	54.5	34	21	35	10

Rectangular Caps/Sleeves

SR 1524

Black Flexible PVC

- Ideal for finishing flat handles
- Excellent electrical insulation properties



Round Ends

Part Number	Dimensions (mm)					Standard Pack Quantity
	l1	l1 (ins)	l2	l2 (ins)	L	
RRWA-91768-060	29.7	-	2.5	-	60	500
RRWA-91616-100	19.0	-	3.0	-	100	500
RRWA-91783-060	17.5	-	3.0	-	60	500
RRWA-91618-100	25.0	-	3.0	-	100	500
RRWA-91620-110	12.7	1/2	3.2	1/8	110	1500
RRWA-91622-110	19.1	3/4	3.2	1/8	110	600
RRWA-91624-110	25.4	1	3.2	1/8	110	250
RRWA-91688-110	19.0	-	6.0	-	110	500
RRWA-91626-110	25.0	-	6.0	-	110	400
RRWA-91689-110	30.0	-	6.0	-	110	400
RRWA-91628-110	25.4	1	6.4	1/4	110	400

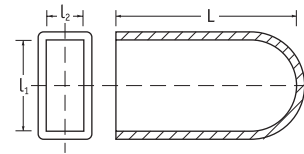

Round End (RR)

Handle Grips

SR 1525

Black PVC

- Broad range
- Ideal for a variety of applications



Type 1

Type 2

Type 3

Type 1-12

Part Number	Dimensions (mm)		Type	Length (mm)	Standard Pack Quantity
	(mm)	(ins)			
10130	19.1	3/4	1	75	800
10131	22.2	7/8	1	75	400
10161	22.2	7/8	2	105	250
10188	19.1	3/4	2	105	250
10189	25.4	1	2	105	100
10126	25.4	1	3	110	250
10156	22.2	7/8	3	110	250
50521*	15.9	5/8	4	75	700
50640	19.1	3/4	4	75	600
15358	13.0	1/2	5	108	600
10186	19.1	3/4	6	110	400
FCWA-0127-110	13.0	1/2	7	110	600
FCWA-0159-110	15.9	5/8	7	110	1000
FCWA-0191-110	19.1	3/4	7	110	800
FCWA-0222-110	22.2	7/8	7	110	250
FCWA-0254-110	25.4	1	7	110	250
NGWA-0191-110	19.1	3/4	8	110	300
NGWA-0222-110	22.2	7/8	8	110	300
NGWA-0254-110	25.4	1	8	110	300
PGWA-0191-400	19.1	3/4	9	400	125
HGWA-0254-150	25.4	1	10	150	250
RGWA-0127-230	13.0	1/2	11	230	400
SGWA-0191-110	19.1	3/4	12	110	300
SGWA-0222-110	22.2	7/8	12	110	300
SGWA-0254-110	25.4	1	12	110	300

*White flexible PVC.



Type 4

Type 5

Type 6

Type 7

Type 8

Type 9

Type 10

Type 11

Type 12

Premium Handwheels

SR 1580

Black Phenolic

- Types 1 and 3 - Male Handwheels with plated steel stud
- Types 1 and 3 - Female Handwheels with plated steel insert
- Types 2 and 4 - Female bush inserted allows male thread to pass through



Type 1 (Male)



Type 3 (Female)



Type 1 (Female)



Type 3 (Male)



Type 2



Type 4

Male

Part Number	Type	Handwheel Diameter (mm)	Thread Size	Stud Length	Standard Pack Quantity
462051	1	32	M6	15	200
462052	1	32	M6	30	200
462053	1	40	M8	20	125
462054	1	40	M8	30	125
460561	1	50	M8	25	100
462055	1	50	M10	30	100
462056	1	50	M10	40	100
460562	1	60	M10	30	100
460563	1	80	M12	40	50
462057	3	32	M6	15	200
462058	3	32	M6	20	200
462059	3	32	M6	30	200
462060	3	40	M8	20	100
462061	3	40	M8	30	100
462062	3	50	M8	30	80
462063	3	50	M10	30	80
462064	3	63	M8	20	50
462065	3	63	M10	30	40
462066	3	63	M12	25	40

Female

Part Number	Type	Handwheel Diameter (mm)	Thread Size	Standard Pack Quantity
1254995	1	32	M6	1000
1254996	1	40	M8	500
460558*	1	50	M8	100
1254997	1	50	M10	250
460559*	1	60	M10	100
462070	1	63	M10	80
1254998	1	63	M12	100
460560*	1	80	M12	100
462072	1	80	M16	35
462073	3	32	M5	250
1254999	3	32	M6	500
462075	3	40	M6	200
1255000	3	40	M8	250
462077	3	50	M8	100
1255001	3	50	M10	250
462079	3	50	M12	100
462080	3	63	M8	50
462081	3	63	M10	50
1255002	3	63	M12	100
462083	3	80	M10	25
462084	3	80	M12	25
1255003	3	80	M16	100

*With aluminium insert.

Threaded all the way through

Part Number	Type	Handwheel Diameter (mm)	Thread Size	Standard Pack Quantity
460564	2	50	M8	100
460565	2	60	M10	100
460566	2	80	M12	100
462086	4	30	M5	50
462087	4	30	M6	50
462088	4	30	M8	50
462089	4	40	M6	50
462090	4	40	M8	50
462091	4	40	M10	50
462092	4	50	M10	25
462093	4	50	M12	25
462094	4	60	M10	20
462095	4	60	M12	20

Handwheels

SR 1580

- Standard Handwheels with moulded in studs and inserts for maximum strength
- Female Lightweight Handwheels applied by inserting an M6 or M8 bolt into the head (not supplied)

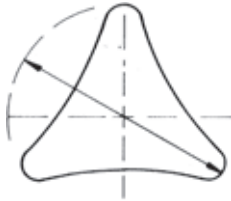

Type 1
Triangular



Type 2
Star

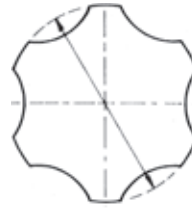

Type 3
Scalloped



Type 4
5 Lobe

Male – Standard (Black PA)

Part Number	Type	Handwheel Diameter (mm)	Thread Size	Stud Length	Standard Pack Quantity
497470	1	40	M6	20.0	500
497483	1	40	M6	35.0	500
497480	1	40	M8	15.0	500
497471	1	40	M8	20.0	500
497481	1	40	M8	25.0	500
497484	1	40	M8	35.0	500
497488	1	60	M8	15.0	500
497473	1	60	M8	20.0	500
497482	1	60	M8	30.0	250
497485	1	60	M8	40.0	250
497489	2	40	M6	20.0	500
497501	2	40	M6	35.0	500
497497	2	40	M8	15.0	500
497491	2	40	M8	20.0	500
497498	2	40	M8	25.0	1000
497502	2	40	M8	35.0	500
497475	2	60	M8	20.0	500
497486	2	60	M8	40.0	500
465426	3	30	M6	12.0	500
465425	3	30	M6	17.0	500
465423	3	30	M6	20.0	500
465429	3	30	M8	20.0	500
497494	3	40	M6	20.0	500
497503	3	40	M6	35.0	500
497499	3	40	M8	15.0	500
497496	3	40	M8	20.0	500
497500	3	40	M8	25.0	1000
497504	3	40	M8	35.0	500
465428	3	50	M10	25.0	150
465427	3	50	M10	30.0	150
462122	3	50	M8	10.0	250
465432	3	50	M8	20.0	250
465431	3	50	M8	30.0	250
497478	3	60	M8	20.0	100
497487	3	60	M8	40.0	250
462104	4	45	M8	22.0	650
462105	4	45	M8	37.5	550

Female – Standard (Black PA)

Part Number	Type	Handwheel Diameter (mm)	Thread Size	Standard Pack Quantity
497493	1	40	M6	500
497472	1	40	M8	500
497474	1	60	M8	250
497490	2	40	M6	500
497492	2	40	M8	500
497476	2	60	M8	500
497495	3	40	M6	500
497477	3	40	M8	500
465422	3	50	M8	150
465424	3	50	M10	150
497479	3	60	M8	250
465430	3	60	M10	150

Female – Lightweight (Black Polypropylene)

Part Number	Type	Handwheel Diameter (mm)	Thread Size	Standard Pack Quantity
10822	1	45	M6	1000
10823	3	50	M6	500
10829	3	50	M8	500

HANDWHEELS AND KNOBS

Lobe Knob with caps

SR 6404

Polypropylene

- Black body with cap in black, orange, grey, red
- Protruding 0.3 mm metal shoulder ensures a metal-to-metal assembly

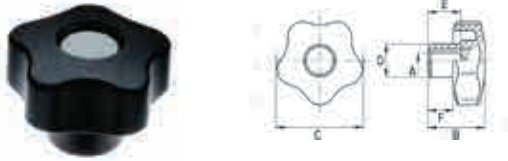

Part Number	Colour	Dimensions (mm)						Standard Pack Quantity
		A	B	C	D	E	F	
264042559911	Black	M4	19	25	13	10	8	10
264052559911	Black	M5	19	25	13	10	8	10
264063259911	Black	M6	23	32	15	12	10	10
264063200911	Orange	M6	23	32	15	12	10	10
264063261311	Grey	M6	23	32	15	12	10	10
264063218211	Red	M6	23	32	15	12	10	10
264084059911	Black	M8	27	40	17	18	12	10
264084000911	Orange	M8	27	40	17	18	12	10
264084061311	Grey	M8	27	40	17	18	12	10
264084018211	Red	M8	27	40	17	18	12	10
264105059911	Black	M10	32	50	19	20	14	10
264105000911	Orange	M10	32	50	19	20	14	10
264105061311	Grey	M10	32	50	19	20	14	10
264105018211	Red	M10	32	50	19	20	14	10
264126359911	Black	M12	37	63	22	26	16	10
264126300911	Orange	M12	37	63	22	26	16	10
264126361311	Grey	M12	37	63	22	26	16	10
264126318211	Red	M12	37	63	22	26	16	10

Soft Touch Lobe Knob

SR 6406

Polypropylene Coated with 'Soft Touch' elastomer

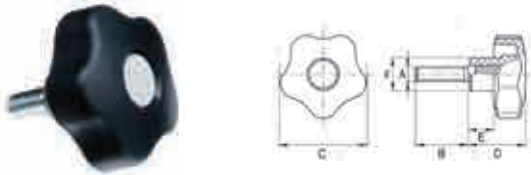

Part Number	Colour	Dimensions (mm)						Standard Pack Quantity
		A	B	C	D	E	F	
268081659939	Black	M8	16	43	29	11	17	1
268081600939	Orange	M8	16	43	29	11	17	1
268081661339	Grey	M8	16	43	29	11	17	1
268081618239	Red	M8	16	43	29	11	17	1
268082059939	Black	M8	20	43	29	11	17	1
268082000939	Orange	M8	20	43	29	11	17	1
268082061339	Grey	M8	20	43	29	11	17	1
268082018239	Red	M8	20	43	29	11	17	1
268102059939	Black	M10	20	53	34	13	19	1
268102000939	Orange	M10	20	53	34	13	19	1
268102061339	Grey	M10	20	53	34	13	19	1
268102018239	Red	M10	20	53	34	13	19	1
268103059939	Black	M10	30	53	34	13	19	1
268103000939	Orange	M10	30	53	34	13	19	1
268103061339	Grey	M10	30	53	34	13	19	1
268103018239	Red	M10	30	53	34	13	19	1

Lobe Knob

SR 6405

Polypropylene

- Black body with cap in black, orange, grey, red
- Zinc plated steel stud

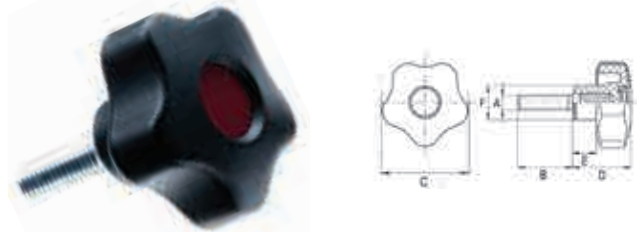

Part Number	Colour	Dimensions (mm)						Standard Pack Quantity
		A	B	C	D	E	F	
266051059911	Black	M5	10	25	19	8	13	10
266051659911	Black	M5	16	25	19	8	13	10
266052059911	Black	M5	20	25	19	8	13	10
266061659911	Black	M6	16	32	23	10	15	10
266061600911	Orange	M6	16	32	23	10	15	10
266061661311	Grey	M6	16	32	23	10	15	10
266061618211	Red	M6	16	32	23	10	15	10
266062059911	Black	M6	20	32	23	10	15	10
266062000911	Orange	M6	20	32	23	10	15	10
266062061311	Grey	M6	20	32	23	10	15	10
266062018211	Red	M6	20	32	23	10	15	10
266063059911	Black	M6	30	32	23	10	15	10
266063000911	Orange	M6	30	32	23	10	15	10
266063061311	Grey	M6	30	32	23	10	15	10
266063018211	Red	M6	30	32	23	10	15	10
266081659911	Black	M8	16	40	27	12	17	10
266081600911	Orange	M8	16	40	27	12	17	10
266081661311	Grey	M8	16	40	27	12	17	10
266081618211	Red	M8	16	40	27	12	17	10
266082559911	Black	M8	25	40	27	12	17	10
266082500911	Orange	M8	25	40	27	12	17	10
266082561311	Grey	M8	25	40	27	12	17	10
266082518211	Red	M8	25	40	27	12	17	10
266083559911	Black	M8	35	40	27	12	17	10
266083500911	Orange	M8	35	40	27	12	17	10
266083561311	Grey	M8	35	40	27	12	17	10
266083518211	Red	M8	35	40	27	12	17	10
266102059911	Black	M10	20	50	32	14	19	10
266102000911	Orange	M10	20	50	32	14	19	10
266102061311	Grey	M10	20	50	32	14	19	10
266102018211	Red	M10	20	50	32	14	19	10
266103059911	Black	M10	30	50	32	14	19	10
266103000911	Orange	M10	30	50	32	14	19	10
266103061311	Grey	M10	30	50	32	14	19	10
266103018211	Red	M10	30	50	32	14	19	10
266104059911	Black	M10	40	50	32	14	19	10
266104000911	Orange	M10	40	50	32	14	19	10
266104061311	Grey	M10	40	50	32	14	19	10
266104018211	Red	M10	40	50	32	14	19	10
266123059911	Black	M12	30	63	37	16	22	10
266123000911	Orange	M12	30	63	37	16	22	10
266123061311	Grey	M12	30	63	37	16	22	10
266123018211	Red	M12	30	63	37	16	22	10

Polypropylene Scalloped Handwheel

SR 5460

Polypropylene

- Lightweight yet strong design
- Available with zinc plated steel or 304 stainless steel threads

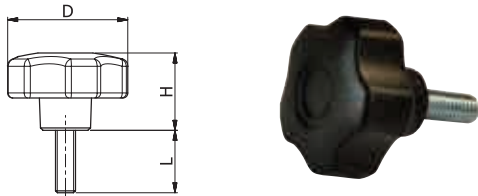

Male

Part Number		Thread Size	Dimensions (mm)			Standard Pack Quantity
Steel	Stainless Steel		L	D	H	
-	493900	M6	15	28	25	10
493901	493902	M6	20	28	25	10
493908	493907	M6	25	40	29	10
493910	493909	M8	20	40	29	10
493912	493911	M8	30	40	29	10
493920	493919	M8	25	50	30	10
493929	493928	M10	25	60	35	10
493931	493930	M12	30	60	35	10

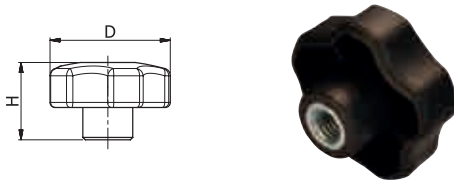

Female

Part Number		Thread Size	Dimensions (mm)		Standard Pack Quantity
Steel	Stainless Steel		D	H	
493899	493898	M6	28	25	10
493906	493905	M8	40	29	10
493918	493917	M8	50	30	10
493916	493915	M10	50	30	10
493925	493924	M10	60	35	10
493927	493926	M12	60	35	10

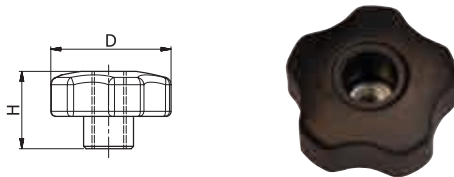

Threaded All The Way Through

Part Number		Thread Size	Dimensions (mm)		Standard Pack Quantity
Steel	Stainless Steel		D	H	
493904	493903	M6	28	25	10
493914	493913	M8	40	29	10
-	493923	M8	50	30	10
493922	493921	M10	50	30	10
493933	493932	M12	60	35	10

Polypropylene Star Handwheel

SR 5460

Polypropylene

- Lightweight yet strong design
- Available with zinc plated steel or 304 stainless steel threads

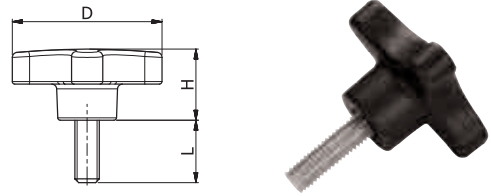

Male

Part Number		Thread Size	Dimensions (mm)			Standard Pack Quantity
Steel	Stainless Steel		L	D	H	
493936	493935	M6	38	25	23	10
493938	493937	M8	38	20	23	10
493940	493939	M8	38	30	23	10
493947	493946	M8	50	25	26	10
493954	493953	M10	60	25	29	10
493955	-	M12	60	30	29	10

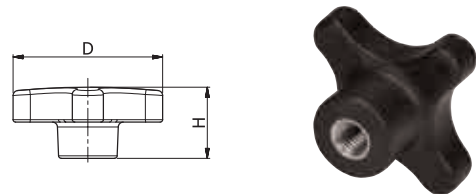

Female

Part Number		Thread Size	Dimensions (mm)		Standard Pack Quantity
Steel	Stainless Steel		D	H	
493934	-	M8	38	23	10
493945	493944	M8	50	26	10
-	493943	M10	50	26	10
493950	-	M10	60	29	10
493952	493951	M12	60	26	10

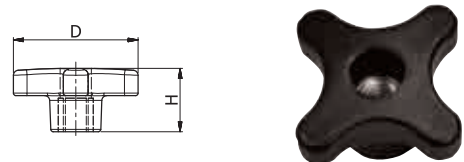

Threaded All The Way Through

Part Number		Thread Size	Dimensions (mm)		Standard Pack Quantity
Steel	Stainless Steel		D	H	
493942	493941	M8	38	23	10
493949	493948	M10	50	26	10

HANDWHEELS AND KNOBS

Lobe Knobs

SR 6516

Glass-fibre reinforced polyamide based (PA) technopolymer

- Resistant to solvents, oils and greases
- The five-lobe shape delivers a very strong grip
- Colour – Black, matte finish
- Type 1: Lobe knob with brass boss, threaded blind hole
- Type 2: Lobe knob with AISI 303 stainless steel boss, threaded blind hole
- Type 3: Lobe knob with zinc-plated steel threaded stud
- Type 4: Lobe Knob with AISI 303 stainless steel threaded stud



Type 1

Type 2

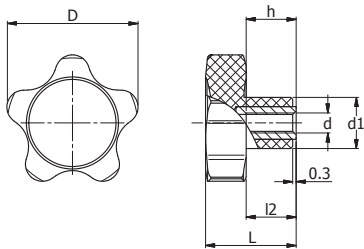

Type 1 & 2



Type 3

Type 4

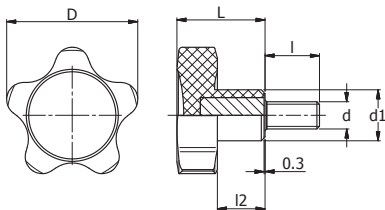

Type 3 & 4

Part Number	Type	Dimensions (mm)				Mounting Hole		Weight (Grams)	Standard Pack Quantity
		D	L	d1	l2	d6H	h		
1218996	1	25	20	12	10	M4	10	7	25
1219009	1	32	22.5	14	12.5	M5	10	15	25
1219010	1	32	22.5	14	12.5	M6	10	14	25
1219023	1	40	26	15	14	M6	12	25	25
1219024	1	40	26	15	14	M8	13	23	25
1219037	1	50	31	18	17	M8	15	44	10
1219036	1	50	31	18	17	M10	17	40	10
1219046	1	60	36.5	21	21	M10	20	63	10
1219047	1	60	36.5	21	21	M12	20	54	10

Part Number	Type	Dimensions (mm)				Mounting Hole		Weight (Grams)	Standard Pack Quantity
		D	L	d1	l2	d6H	h		
1219006	2	25	20	12	10	M5	10	7	25
1219003	2	25	20	12	10	M6	10	7	25
1219014	2	32	22.5	14	12.5	M5	10	15	25
1219016	2	32	22.5	14	12.5	M6	10	15	25
1219031	2	40	26	15	14	M8	13	24	25
1219041	2	50	31	18	17	M8	15	45	10
1219042	2	50	31	18	17	M10	17	42	10
1219051	2	60	36.5	21	21	M10	17	64	10
1219052	2	60	36.5	21	21	M12	20	54	10

Part Number	Type	Dimensions (mm)				Threaded Stud		Weight (Grams)	Standard Pack Quantity
		D	L	d1	l	d6g	l2		
1218997	3	25	20	12	6	M4	10	6	25
1218998	3	25	20	12	10	M5	10	8	25
1218999	3	25	20	12	20	M5	10	10	25
1219000	3	25	20	12	10	M6	10	10	25
1219001	3	25	20	12	16	M6	10	11	25
1219002	3	25	20	12	35	M6	10	15	25
1219011	3	32	22.5	14	16	M6	12.5	15	25
1219012	3	32	22.5	14	20	M6	12.5	16	25
1219013	3	32	22.5	14	30	M6	12.5	19	25
1219015	3	32	22.5	14	30	M8	12.5	18	25
1219025	3	40	26	15	40	M6	14	20	25
1219026	3	40	26	15	16	M8	14	23	25
1219027	3	40	26	15	20	M8	14	28	25
1219028	3	40	26	15	30	M8	14	32	25
1219029	3	40	26	15	40	M8	14	36	25
1219030	3	40	26	15	70	M8	14	42	25
1219038	3	50	31	18	20	M10	17	47	10
1219039	3	50	31	18	30	M10	17	57	10
1219040	3	50	31	18	40	M10	17	66	10
1219048	3	60	36.5	21	30	M12	21	69	10
1219049	3	60	36.5	21	40	M12	21	80	10
1219050	3	60	36.5	21	50	M12	21	91	10

Part Number	Type	Dimensions (mm)				Threaded Stud		Weight (Grams)	Standard Pack Quantity
		D	L	d1	l	d6g	l2		
1219007	4	25	20	12	10	M5	10	8	25
1219008	4	25	20	12	16	M5	10	9	25
1219004	4	25	20	12	16	M6	10	11	25
1219005	4	25	20	12	20	M6	10	12	25
1219017	4	32	22.5	14	10	M6	12.5	17	25
1219018	4	32	22.5	14	16	M6	12.5	15	25
1219019	4	32	22.5	14	20	M6	12.5	16	25
1219020	4	32	22.5	14	30	M6	12.5	19	25
1219022	4	32	22.5	14	25	M8	12.5	21	25
1219032	4	40	26	15	16	M8	14	26	25
1219033	4	40	26	15	20	M8	14	28	25
1219034	4	40	26	15	30	M8	14	32	25
1219035	4	40	26	15	40	M8	14	36	25
1219043	4	50	31	18	20	M10	17	47	10
1219044	4	50	31	18	30	M10	17	57	10
1219045	4	50	31	18	40	M10	17	67	10
1219053	4	60	36.5	21	30	M12	21	70	10
1219054	4	60	36.5	21	40	M12	21	81	10
1219055	4	60	36.5	21	50	M12	21	92	10

Soft Touch Lobe Knobs

SR 6517

PP

- The surface, coated with "soft-touch" elastomer, improves the grip even in the presence of oils, greases and sweat from the hand
- Style - Brass boss, threaded blind hole
- Colour - Black, matte finish

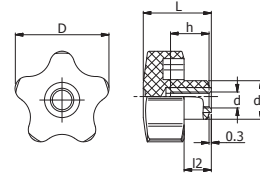

Part Number	Dimensions (mm)				Mounting Hole		Weight (Grams)	Standard Pack Quantity
	D	L	d1	l2	d6H	h		
1218970	43	29	17	11	M8	13	20	25
1218972	53	34	19	13	M8	15	33	10
1218971	53	34	19	13	M10	17	36	10
1218973	66	38.5	21.5	15.5	M10	17	44	10
1218974	77	46	26	21	M12	20	51	10

Round Cap Lobe Knobs

SR 6518

Knob - Glass-fibre reinforced polyamide based (PA) technopolymer

- Resistant to solvents, oils, greases and other chemical agents
- Grey-black, matte finish

Cap - Technopolymer in black, matte finish

- Ultrasonically welded to the body of the knob
- Type 1: Black-oxide steel boss, H9 reamed blind hole
- Type 2: Brass boss, threaded blind hole
- Type 3: Black-oxide steel boss, H7 reamed pass-through hole
- Type 4: Zinc-plated steel threaded stud with chamfered flat end as in UNI 947 : ISO 4753



Type 1 & 2



Type 3



Type 4

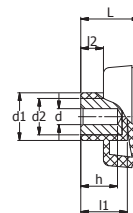

Type 1

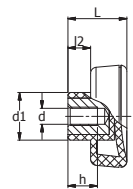

Type 2

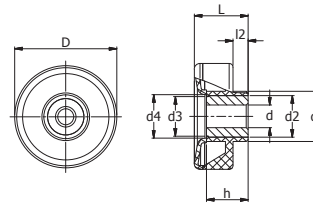

Type 3

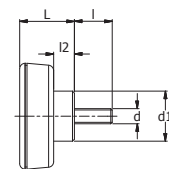

Type 4

Part Number	Type	Dimensions (mm)						Mounting Hole		Weight (Grams)	Standard Pack Quantity
		D	L	d1	d2	l1	l2	dH9	h		
1218975	1	45	26	21	14	19	10	8	14	37	1
1218980	1	56	29	26.5	14	18	11	8	14	53	1
1218990	1	70	35	32.5	22	25	13	10	21	112	1

Part Number	Type	Dimensions (mm)						Mounting Hole		Weight (Grams)	Standard Pack Quantity
		D	L	d1	l2	d6H	h				
1218976	2	45	26	21	10	M6	12	29		1	
1218977	2	45	26	21	10	M8	13	30		1	
1218982	2	56	29	26.5	11	M8	13	41		1	
1218981	2	56	29	26.5	11	M10	13	39		1	
1218991	2	70	35	32.5	13	M10	18	68		1	
1218992	2	70	35	32.5	13	M12	17	66		1	

Part Number	Type	Dimensions (mm)						Mounting Hole		Weight (Grams)	Standard Pack Quantity	
		D	L	d1	d2	d3	d4	l2	dH7			h
1218983	3	56	29	26.5	22	20.5	23	11	10	22	80	1
1218993	3	70	35	32.5	26	24	28	13	12	27	132	1

Part Number	Type	Dimensions (mm)				Threaded Stud		Weight (Grams)	Standard Pack Quantity
		D	L	d1	l2	d6g	l		
1218978	4	45	26	21	10	M8	20	33	1
1218979	4	45	26	21	10	M8	30	36	1
1218987	4	56	29	26.5	11	M8	20	46	1
1218988	4	56	29	26.5	11	M8	30	49	1
1218989	4	56	29	26.5	11	M8	40	52	1
1218984	4	56	29	26.5	11	M10	20	55	1
1218985	4	56	29	26.5	11	M10	30	61	1
1218986	4	56	29	26.5	11	M10	40	67	1
1218994	4	70	35	32.5	13	M10	30	83	1
1218995	4	70	35	32.5	13	M12	50	102	1

Soft Touch Knobs

SR 5414

Inner moulding: Polypropylene

Over moulding: TPE

- Provides extra grip and high touch finish
- Type 1 & 3 Insert material: Brass
- Type 2 Stud material: Zinc Plated Steel

Type 1 & 3

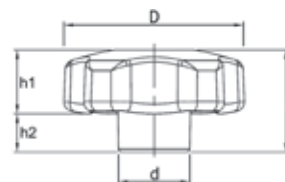

Type 1



Type 2



Type 3



Type 2

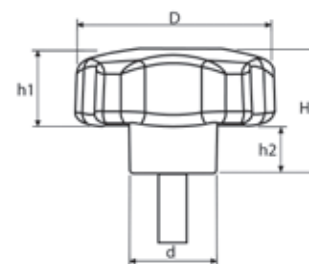

Part Number	Type	Thread Size	Dimensions (mm)					Thread Length (mm)	Standard Pack Quantity
			D	h1	d	h2	H		
491313	1	M5	28.0	16.0	12.0	10.0	26.0	-	10
491315	1	M6	28.0	16.0	12.0	10.0	26.0	-	10
491323	1	M8	40.0	17.0	18.0	12.0	30.0	-	10
491329	1	M6	50.0	19.0	21.0	12.0	31.0	-	10
491331	1	M8	50.0	19.0	21.0	12.0	31.0	-	10
491336	1	M8	60.0	21.0	23.0	13.0	35.0	-	10
491338	1	M10	60.0	21.0	23.0	13.0	35.0	-	10
491317	2	M5	28.0	16.0	12.0	10.0	26.0	10.0	10
491318	2	M5	28.0	16.0	12.0	10.0	26.0	15.0	10
491319	2	M5	28.0	16.0	12.0	10.0	26.0	20.0	10
491320	2	M6	28.0	16.0	12.0	10.0	26.0	15.0	10
491321	2	M6	28.0	16.0	12.0	10.0	26.0	20.0	10
491325	2	M6	40.0	17.0	18.0	12.0	29.0	25.0	10
491326	2	M8	40.0	17.0	18.0	12.0	29.0	16.0	10
491327	2	M8	40.0	17.0	18.0	12.0	29.0	25.0	10
491328	2	M8	40.0	17.0	18.0	12.0	29.0	35.0	10
491333	2	M6	50.0	19.0	21.0	12.0	31.0	35.0	10
491334	2	M8	50.0	19.0	21.0	12.0	31.0	35.0	10
491335	2	M8	50.0	19.0	21.0	12.0	31.0	40.0	10
491340	2	M8	60.0	21.0	23.0	13.0	34.0	20.0	10
491341	2	M8	60.0	21.0	23.0	13.0	34.0	30.0	10
491342	2	M10	60.0	21.0	23.0	13.0	34.0	30.0	10
491314	3	M5	28.0	16.0	12.0	10.0	26.0	-	5
491316	3	M6	28.0	16.0	12.0	10.0	26.0	-	5
491322	3	M6	40.0	17.0	18.0	12.0	30.0	-	5
491324	3	M8	40.0	17.0	18.0	12.0	30.0	-	5
491330	3	M6	50.0	19.0	21.0	12.0	31.0	-	5
491332	3	M8	50.0	19.0	21.0	12.0	31.0	-	5
491337	3	M8	60.0	21.0	23.0	13.0	35.0	-	5
491339	3	M10	60.0	21.0	23.0	13.0	35.0	-	5

Lobe Knobs

SR 6519

PF or PA

- Material - Type 1 & 3 are made from Phenolic based (PF) Duroplast and Type 2 is made from glass reinforced polyamide based (PA) technopolymer. All types are resistant to solvents, oils, greases and other chemical agents.
- Colour - Black, glossy finish
- Type 1: Black-oxide steel hub, pre-drilled blind hole.
- Type 2: Black-oxide steel or brass hub available in different styles
 - Not drilled
 - H7 reamed pass-through hole (black-oxide steel hub)
 - 6H threaded pass-through hole (black-oxide steel hub)
- Type 3: Black-oxide steel hub, not drilled

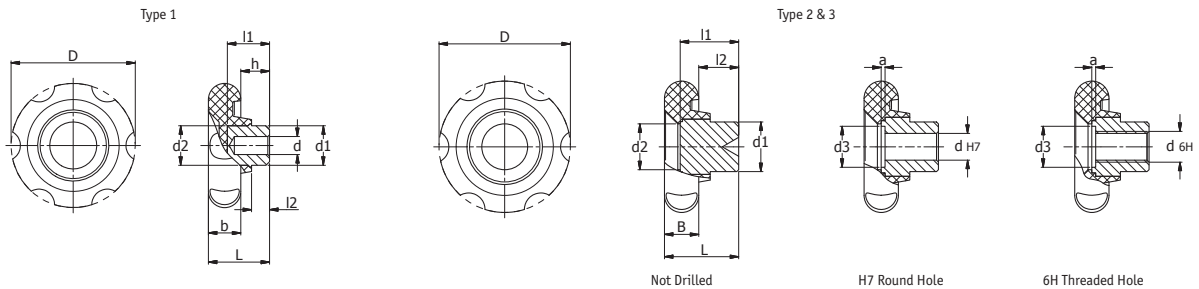

Part Number	Type	Style	Main Dimensions							Hole Dimensions		Weight (Grams)	Standard Pack Quantity
			D	L	B	d1	d2	l1	l2	d-0.1	h		
1219060	1	Pre-drilled blind hole	51	29	13	20	18	20	10	6	15	67	10
1219061	1	Pre-drilled blind hole	61	32	16	20	18	20	10	6	15	87	10
1219062	1	Pre-drilled blind hole	69	36	18	24	20	23	12	6	15	126	10
1219063	1	Pre-drilled blind hole	82	40	19	24	20	23	12	6	15	160	1
1219056	1	Pre-drilled blind hole	99	44	20	36	30	31	14	8	22	325	1
1219058	1	Pre-drilled blind hole	129	47	22	40	40	30	13	8	20	500	1

Part Number	Type	Style	Main Dimensions							Mounting Hole			Weight (Grams)	Standard Pack Quantity	
			D	L	B	d1	d2	l2	d3	a	d6H	dH7			l
1219064	2	Not Drilled (steel hub)	50	29	13	20	18	10	-	-	-	-	21	72	10
1219066	2	H7 reamed pass-through hole	50	29	13	20	18	10	-	-	-	8	21	65	10
1219065	2	H7 reamed pass-through hole	50	29	13	20	18	10	-	-	-	10	21	60	10
1219067	2	6H threaded pass-through hole	50	29	13	20	18	10	-	-	M8	-	21	68	10
1219068	2	Not Drilled (brass hub)	50	29	13	20	18	10	-	-	-	-	21	72	10
1219069	2	Not Drilled (steel hub)	61	30	16	25	24	11	-	-	-	-	23	126	10
1219070	2	H7 reamed pass-through hole	61	30	16	25	24	11	15.2	0.8	-	10	23	114	10
1219071	2	H7 reamed pass-through hole	61	30	16	25	24	11	18.1	0.8	-	12	23	110	10
1219072	2	6H threaded pass-through hole	61	30	16	25	24	11	18.1	0.8	M10	-	23	117	10
1219073	2	Not Drilled (brass hub)	61	30	16	25	24	11	-	-	-	-	23	126	10
1219074	2	Not Drilled (steel hub)	70	33	18	30	30	12	-	-	-	-	25	190	10
1219075	2	H7 reamed pass-through hole	70	33	18	30	30	12	18.1	0.8	-	12	25	170	10
1219076	2	6H threaded pass-through hole	70	33	18	30	30	12	18.1	0.8	M12	-	25	175	10
1219077	2	Not Drilled (brass hub)	70	33	18	30	30	12	-	-	-	-	25	190	10
1219078	2	Not Drilled (steel hub)	80	40	19	35	34	15	-	-	-	-	30	300	1
1219079	2	H7 reamed pass-through hole	80	40	19	35	34	15	21.4	1.5	-	16	30	255	1
1219080	2	Not Drilled (steel hub)	80	40	19	35	34	15	18.1	0.8	M16	-	30	260	1
1219081	2	Not Drilled (brass hub)	80	40	19	35	34	15	-	-	-	-	30	300	1

Part Number	Type	Style	Main Dimensions							Mounting Hole			Weight (Grams)	Standard Pack Quantity	
			D	L	B	d1	d2	l2	d3	a	d6H	dH7			l
1219057	3	Not Drilled	99	44	20	36	34	14	-	-	-	-	34	405	1
1219059	3	Not Drilled	129	47	22	40	36	13	-	-	-	-	34	560	1

Grip Knobs

SR 1538

Black PA 6 or Black Phenolic

- Knurled matt finish provides easy grip
- High-impact resistant durable knob
- Resistant to oils, fuels and greases



Type 1

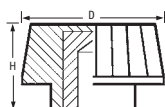

Type 2

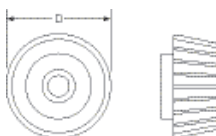

Type 3



Type 1 – Matt Finish – High-Impact Resistant Nylon 6 – Male

Part Number	Dimensions (mm)		Thread Size	Stud Length (mm)	Standard Pack Quantity
	D	H			
466346	15	11	M4	10	500
466347	15	11	M5	10	500
466348	22	16	M6	15	500
466349	22	16	M8	15	500

Type 1 – Matt Finish – High-Impact Resistant Nylon 6 – Female

Part Number	Dimensions (mm)		Thread Size	Standard Pack Quantity
	D	H		
466342	15	11	M4	500
466343	15	11	M5	500
466344	22	16	M6	500
466345	22	16	M8	500

Type 2 – Black Nylon – Male

Part Number	Thread Size	D (mm)	Stud Length (mm)	Standard Pack Quantity
KTSR-15M04M10	M4	15	10	500
KTSR-15M04M15	M4	15	15	500
KTSR-15M04M25	M4	15	25	500
KTSR-23M05M10	M5	23	10	500
KTSR-23M05M15	M5	23	15	500
KTSR-23M05M25	M5	23	25	500
KTSR-23M06M10	M6	23	10	500
KTSR-23M06M15	M6	23	15	500
KTSR-23M06M25	M6	23	25	500
KTSR-23M06M30	M6	23	30	500
KTSR-23M06M40	M6	23	40	500
KTSR-28M08M25	M8	28	25	500
KTSR-28M08M30	M8	28	30	500
KTSR-28M08M50	M8	28	50	500

Type 2 – Black Nylon – Female

Part Number	Thread Size	D (mm)	Standard Pack Quantity
KTSR-15M04F	M4	15	500
KTSR-23M05F	M5	23	500
KTSR-23M06F	M6	23	500
KTSR-28M08F	M8	28	500

Type 3 – Gloss Finish – Phenolic – Male

Part Number	Dimensions (mm)		Thread Size	Stud Length (mm)	Standard Pack Quantity
	D	H			
460585	14	16	M4	10	500
460588	20	26	M6	15	500

Type 3 – Gloss Finish – Phenolic – Female

Part Number	Dimensions (mm)		Thread Size	Standard Pack Quantity
	D	H		
460582	14	16	M5	500
460583	20	26	M5	500
460584	20	26	M6	500

Push-Pull Knobs

SR 1538

Black PA 6



- Female: brass thread insert
- Male: plated steel threaded stud
- Resistant to oils, fuels and greases

Male

Part Number	Dimensions (mm)		Thread Size	Stud Length (mm)	Standard Pack Quantity
	D	H			
466359	20	20	M5	16	500
466360	25	25	M6	20	250
466361	30	30	M8	30	250

Female

Part Number	Dimensions (mm)		Thread Size	Standard Pack Quantity
	D	H		
466356	20	20	M5	500
466357	25	25	M6	500
466358	30	30	M8	500

Knurled Knob

SR 6127

Black or Orange POM

- Easy assembly on bolts and nuts with 1 hammer-stroke
- Suitable for M4, M5, M6, M8 and M10 hexagon bolts and nuts
- In compliance with DIN 555, 601, 934, 558, 571, 931 and 7976

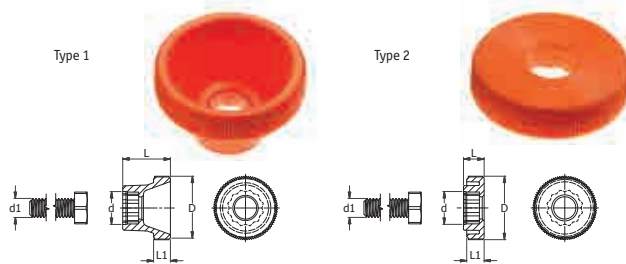

Part Number		Type	Dimensions					Standard Pack Quantity
Black	Orange		d1	d	D	L	L1	
037040159905	037040100905	1	M4	7	13	9.5	3.5	100
037040359905	037040300905	1	M4	7	17	11.5	4.5	100
037050159905	037050100905	1	M5	8	17	11.5	4.5	100
037050359905	037050300905	1	M5	8	20	15	5	100
037060159905	037060100905	1	M6	10	20	15	5	100
037060359905	037060300905	1	M6	10	25	18	6	100
037080159905	037080100905	1	M8	13	25	18	6	100
037080359905	037080300905	1	M8	13	36	23	8	100
037100159905	037100100905	1	M10	17	36	23	8	100
03710059905	037100000905	2	M10	17	36	10	8	100
037040059905	037040000905	2	M4	7	13	4.5	3.5	100
037040259905	037040200905	2	M4	7	17	5.5	4.5	100
037050059905	037050000905	2	M5	8	17	5.5	4.5	100
037050259905	037050200905	2	M5	8	20	6.5	5	100
037060059905	037060000905	2	M6	10	20	6.5	5	100
037060259905	037060200905	2	M6	10	25	8	6	100
037080059905	037080000905	2	M8	13	25	8	6	100
037080259905	037080200905	2	M8	13	36	10	8	100

Thumbs Screw Knobs - Round Acetal

SR 6520

- Can be used as a thumb screw or a knob
- Caps available for use with any length screw
- Multiple colour available

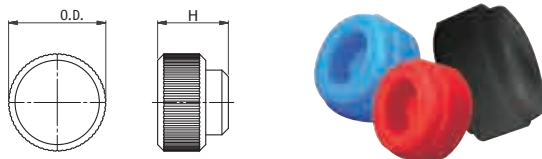

Part Number			Screw Size	OD (mm)	Knob Height (mm)	Standard Pack Quantity
Black	Blue	Red				
TSK390A	TSK405A	TSK420A	M4	12.7	5.6	100
TSK395A	TSK410A	TSK425A	M5	16.6	6.4	100
TSK400A	TSK415A	TSK430A	M6	25.4	9.3	100

Knurled Knob

SR 6127

Black or Orange POM

- Easy assembly on socket head screws with 1 hammer-stroke
- Available for inside hexagon bolts M3 upto M10
- DIN 912, 6912, 7984

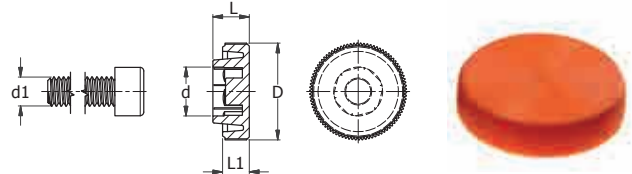

Part Number		Dimensions					Standard Pack Quantity
Black	Orange	d1	d	D	L	L1	
038030059905	038030000905	M3	5.5	11	4.5	3	100
038040059905	038040000905	M4	7	13	5.5	3.5	100
038040159905	038040100905	M4	7	17	5.5	4.5	100
038050059905	038050000905	M5	8.5	17	6.5	4.5	100
038050159905	038050100905	M5	8.5	20	6.5	5	100
038060059905	038060000905	M6	10	20	7.5	5	100
038060159905	038060100905	M6	10	25	7.5	6	100
038080059905	038080000905	M8	13	25	9.5	6	100
038080159905	038080100905	M8	13	36	9.5	8	100
038100059905	038100000905	M10	16	36	12	8	100

Front Plate Knob

SR 6400

PA 6

- Easy mounting of screws by hand or screw driver
- Renders a neat finish
- May serve as buffer, prevents damage

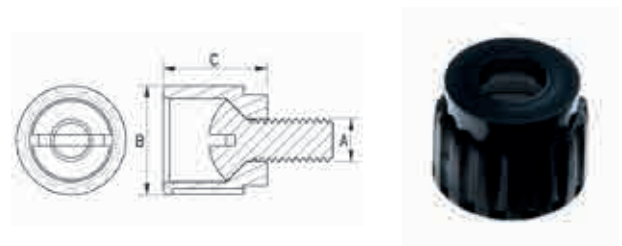

Part Number	Dimensions (mm)			Standard Pack Quantity
	A	B	C	
08400259901	M2.5	7	9	250
084003059901	M3	8.5	10	250
084004059901	M4	10.5	11	250
084005059901	M5	12.5	12	250
084006059901	M6	14.5	13	250

Diamond Cut Knurled Knob with Threaded Blind Hole or Threaded Stud

SR 6521

- Material of the main knob is high-resilience polypropylene based (PP) technopolymer resistant to solvents, oils, greases and other chemical agents. Material of the centre cap is technopolymer with a matte finish
- Type 1: Brass boss, threaded blind hole
- Type 2: Zinc-plated steel threaded stud with chamfered flat end as in UNI 947:ISO 4753

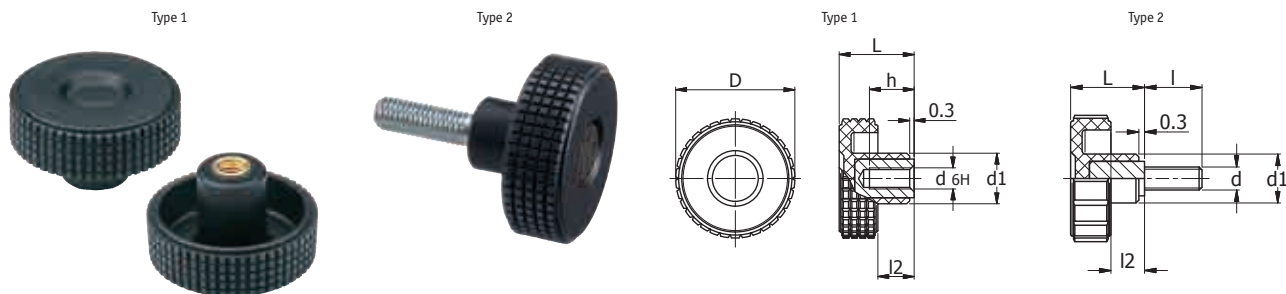

Part Number	Type	Dimensions (mm)				Mounting Hole		Weight (Grams)	Standard Pack Quantity
		D	L	d1	l2	d6H	h		
1219108	1	31	24	15	11.5	M5	10	12	1
1219109	1	31	24	15	11.5	M6	12	17	1
1219118	1	39.5	26.5	17	12.5	M6	12	22	1
1219119	1	39.5	26.5	17	12.5	M8	13	23	1
1219128	1	50	33	20	16	M8	20	32	1
1219127	1	50	33	20	16	M10	18	34	1
1219135	1	61	39	23	18.5	M10	20	50	1
1219136	1	61	39	23	18.5	M12	20	58	1
1219141	1	70	42	24	20.5	M14	20	78	1

Part Number	Type	Dimensions (mm)				Threaded Stud		Weight (Grams)	Standard Pack Quantity
		D	L	d1	l2	d6g	l		
1219110	2	31	24	15	11.5	M5	10	13	1
1219111	2	31	24	15	11.5	M5	20	14	1
1219112	2	31	24	15	11.5	M5	40	16	1
1219113	2	31	24	15	11.5	M6	10	14	1
1219114	2	31	24	15	11.5	M6	16	14	1
1219115	2	31	24	15	11.5	M6	20	15	1
1219116	2	31	24	15	11.5	M6	25	16	1
1219117	2	31	24	15	11.5	M6	30	17	1
1219120	2	39.5	26.5	17	12.5	M6	10	18	1
1219121	2	39.5	26.5	17	12.5	M6	20	20	1
1219122	2	39.5	26.5	17	12.5	M6	40	24	1
1219123	2	39.5	26.5	17	12.5	M8	16	26	1
1219124	2	39.5	26.5	17	12.5	M8	30	30	1
1219125	2	39.5	26.5	17	12.5	M8	40	33	1
1219126	2	39.5	26.5	17	12.5	M8	50	36	1
1219132	2	50	33	20	16	M8	16	36	1
1219133	2	50	33	20	16	M8	30	38	1
1219134	2	50	33	20	16	M8	50	44	1
1219129	2	50	33	20	16	M10	20	42	1
1219130	2	50	33	20	16	M10	30	47	1
1219131	2	50	33	20	16	M10	50	57	1
1219137	2	61	39	23	18.5	M10	20	58	1
1219138	2	61	39	23	18.5	M10	50	73	1
1219139	2	61	39	23	18.5	M12	20	70	1
1219140	2	61	39	23	18.5	M12	30	78	1
1219142	2	70	42	24	20.5	M12	50	105	1

Fluted Grip Knobs with Insert

SR 6402

Polyamide based technopolymer

- Brass female insert with pass-through hole
- Resistant to solvents, oils, greases and other chemicals

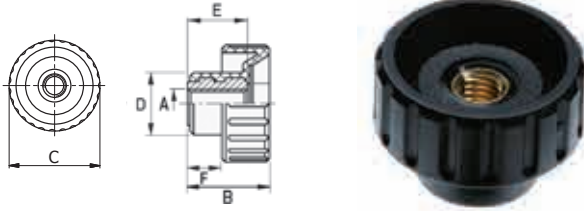

Part Number	Dimensions (mm)						Standard Pack Quantity
	A	B	C	D	E	F	
258041659935	M4	13	16	11	10	5	10
258051659935	M5	13	16	11	10	5	10
258062559935	M6	19	25	16	14	8	10
258083259935	M8	22	32	17	16	9	10

Fluted Grip Knob with Zinc-Plated Steel Threaded Stud

SR 6522

Polyamide based (PA) technopolymer

- Fluted Grip Knob with zinc-plated steel threaded stud, chamfered flat end according to UNI 947 : ISO 4753
- Resistant to solvents, oils, greases and other chemical agents
- Colour - Black, matte finish

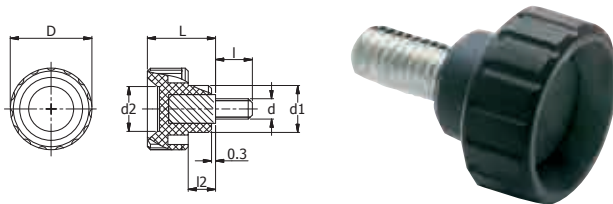

Part Number	Dimensions (mm)					Threaded Stud		Weight (Grams)	Standard Pack Quantity
	D	L	d1	d2	l2	d6g	l		
1219082	16	13	11	9	5	M5	10	6	25
1219083	16	13	11	9	5	M5	16	7	25
1219084	20	16	11.5	11	6	M5	25	9	25
1219085	20	16	11.5	11	6	M6	10	9	25
1219086	20	16	11.5	11	6	M6	16	11	25
1219087	20	16	11.5	11	6	M6	25	13	25
1219088	25	19	16	15	8	M8	16	15	25
1219089	25	19	16	15	8	M8	25	18	25
1219092	32	22	17	21	9	M8	40	25	25
1219090	32	22	17	21	9	M10	20	25	25
1219091	32	22	17	21	9	M10	30	28	25
1219093	40	27	19	25	13	M10	30	37	25

Soft Touch Fluted Grip Knob with Blind Hole or Threaded Stud

SR 6523

- Type 1 – Brass boss, threaded hole
- Type 2 – Zinc-plated steel threaded stud, chamfered flat end according to UNI 947 : ISO 4753
- ‘Soft-touch’ elastomer, improves the grip even in the presence of oils, greases and sweat from the hand
- Material – High-resilience polypropylene based (PP) technopolymer
- Colour – Black, matte finish and other chemicals
- Soft touch elastomer material is certified according to FDA (US Food and Drug administration)

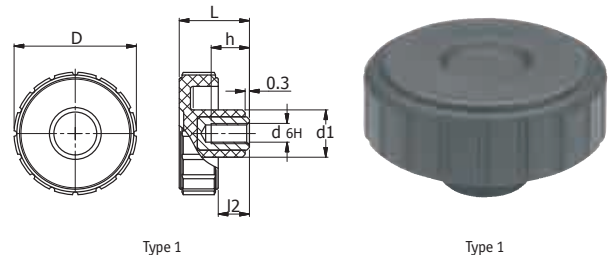

Type 1

Type 1

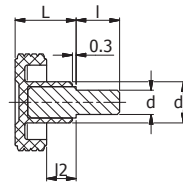

Type 2

Type 2

Part Number	Type	Dimensions (mm)				Mounting Hole		Weight (Grams)	Standard Pack Quantity
		D	L	d1	l2	d6H	h		
1219094	1	44	24	17	10	M6	12	31	10
1219095	1	44	24	17	10	M8	13	30	10
1219101	1	54	30	20	12.5	M10	18	44	10

Part Number	Type	Dimensions (mm)				Threaded Stud		Weight (Grams)	Standard Pack Quantity
		D	L	d1	l2	d6g	l		
1219096	2	44	24	17	10	M6	10	25	10
1219097	2	44	24	17	10	M6	20	30	10
1219098	2	44	24	17	10	M8	16	33	10
1219099	2	44	24	17	10	M8	30	37	10
1219100	2	44	24	17	10	M8	50	47	10
1219105	2	54	30	20	12.5	M8	16	40	10
1219106	2	54	30	20	12.5	M8	30	50	10
1219107	2	54	30	20	12.5	M8	50	64	10
1219102	2	54	30	20	12.5	M10	20	52	10
1219103	2	54	30	20	12.5	M10	30	57	10
1219104	2	54	30	20	12.5	M10	50	73	10

HANDWHEELS AND KNOBS

Knurled Screws

SR 6524

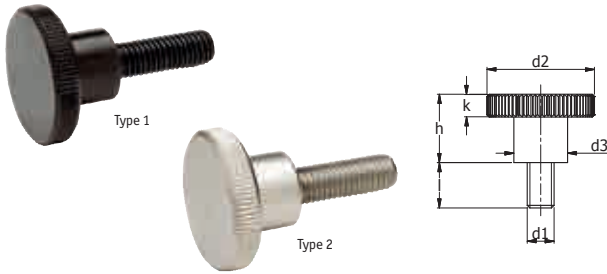

- All Knurled Screws are produced from one piece and threaded over in full length
- Type 1: Made from Steel with a tensile strength class of 5.8 (500 N/mm²) Visible face fine turned and blackened
- Type 2: Made from Stainless Steel AISI 303. Visible face fine turned with a matte shot-blasted finish

Part Number	Dimensions (mm)								Standard Pack Quantity
	Type	d1	Length l	d2	d3	h	k		
1220558	1	M3	6	12	6	7.5	2.5	10	
1220559	2	M3	6	12	6	7.5	3	10	
1220560	1	M3	10	12	6	7.5	2.5	10	
1220561	2	M3	10	12	6	7.5	3	10	
1220562	1	M3	12	12	6	7.5	2.5	10	
1220563	2	M3	12	12	6	7.5	3	10	
1220564	1	M3	16	12	6	7.5	2.5	10	
1220565	2	M3	16	12	6	7.5	3	10	
1220566	1	M4	8	16	8	9.5	3.5	10	
1220567	2	M4	8	16	8	9.5	3.5	10	
1220568	1	M4	10	16	8	9.5	3.5	10	
1220569	2	M4	10	16	8	9.5	3.5	10	
1220570	1	M4	12	16	8	9.5	3.5	10	
1220571	2	M4	12	16	8	9.5	3.5	10	
1220572	1	M4	16	16	8	9.5	3.5	10	
1220573	2	M4	16	16	8	9.5	3.5	10	
1220574	1	M4	20	16	8	9.5	3.5	10	
1220575	2	M4	20	16	8	9.5	3.5	10	
1220576	1	M4	25	16	8	9.5	3.5	10	
1220577	2	M4	25	16	8	9.5	3.5	10	
1220578	1	M5	10	20	10	11.5	4	10	
1220579	2	M5	10	20	10	11.5	4	10	
1220580	1	M5	12	20	10	11.5	4	10	

Part Number	Dimensions (mm)								Standard Pack Quantity
	Type	d1	Length l	d2	d3	h	k		
1220581	2	M5	12	20	10	11.5	4	10	
1220582	1	M5	16	20	10	11.5	4	10	
1220583	2	M5	16	20	10	11.5	4	10	
1220584	1	M5	20	20	10	11.5	4	10	
1220585	2	M5	20	20	10	11.5	4	10	
1220586	1	M5	25	20	10	11.5	4	10	
1220587	2	M5	25	20	10	11.5	4	10	
1220588	1	M5	30	20	10	11.5	4	10	
1220589	2	M5	30	20	10	11.5	4	10	
1220590	1	M6	12	24	12	15	5	10	
1220591	2	M6	12	24	12	15	5	10	
1220592	1	M6	16	24	12	15	5	10	
1220593	2	M6	16	24	12	15	5	10	
1220594	1	M6	20	24	12	15	5	10	
1220595	2	M6	20	24	12	15	5	10	
1220596	1	M6	25	24	12	15	5	10	
1220597	2	M6	25	24	12	15	5	10	
1220598	1	M6	30	24	12	15	5	10	
1220599	2	M6	30	24	12	15	5	10	
1220600	1	M6	35	24	12	15	5	10	
1220601	2	M6	35	24	12	15	5	10	
1220602	1	M8	16	30	16	18	6	10	
1220603	2	M8	16	30	16	18	6	10	
1220604	1	M8	20	30	16	18	6	10	
1220605	2	M8	20	30	16	18	6	10	
1220606	1	M8	25	30	16	18	6	10	
1220607	2	M8	25	30	16	18	6	10	
1220608	1	M8	30	30	16	18	6	10	
1220609	2	M8	30	30	16	18	6	10	
1220610	1	M8	35	30	16	18	6	10	
1220611	2	M8	35	30	16	18	6	10	

Knurled Nuts

SR 6525

- All Knurled Nuts are produced from one piece
- Type 1: Made from Steel with a tensile strength class of 5.8 (500 N/mm²). Visible face fine turned and blackened
- Type 2: Made from Stainless Steel AISI 303. Visible face fine turned with a matt shot-blasted finish

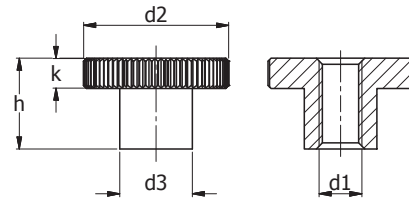

Part Number	Dimensions (mm)							Standard Pack Quantity
	Type	d1	d2	d3	h	k		
1220612	1	M4	16	8	9.5	3.5	10	
1220613	2	M4	16	8	9.5	3.5	10	
1220614	1	M5	20	10	11.5	4	10	
1220615	2	M5	20	10	11.5	4	10	
1220616	1	M6	24	12	15	5	10	
1220617	2	M6	24	12	15	5	10	
1220618	1	M8	30	16	18	6	10	
1220619	2	M8	30	16	18	6	10	
1220620	1	M10	36	20	23	8	10	
1220621	2	M10	36	20	23	8	10	

Stainless Steel Knobs

SR 5415

Stainless Steel 304

- Female Thread
- Type 2: Tapped right through



Type 1: Solid



Type 2: Through Hole

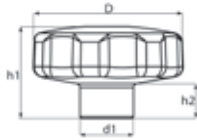

Type 1 & 2

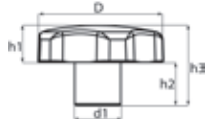

Type 3

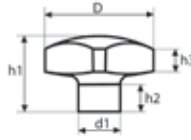

Type 4



Type 3: Pressed



Type 4: Solid Star

Part Number	Type	Dimensions (mm)					Thread Size	Thread Type	Standard Pack Quantity
		D	h1	d1	h2	h3			
491343	1	40.0	24.0	14.0	8.0	-	M6	Matt	5
491344	1	40.0	24.2	14.0	8.0	-	M8	Matt	5
491345	1	50.0	31.2	18.0	10.0	-	M8	Matt	5
491346	1	50.0	31.2	18.0	10.0	-	M10	Matt	5
491347	1	60.0	39.0	20.0	14.3	-	M10	Matt	2
491348	1	60.0	39.0	20.0	15.0	-	M12	Matt	2
491349	2	40.0	24.0	14.0	8.2	-	M8	Matt	5
491350	2	50.0	30.9	18.0	10.0	-	M10	Matt	5
491351	2	60.0	38.6	20.0	14.3	-	M12	Matt	2
491352	3	40.0	12.2	14.0	12.0	24.2	M8	Matt	5
491353	3	50.0	13.7	18.0	18.0	31.2	M10	Matt	5
491354	3	60.0	18.0	20.0	22.0	29.0	M12	Matt	5
491367	4	31.0	21.5	12.0	8.0	6.5	M6	Highly Polished	5

Aluminium Knobs

SR 5416

Aluminium

- Type 1 & 2: female thread
- Highly polished finish

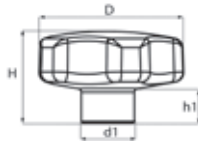

Type 1



Type 2

Part Number	Type	Dimensions (mm)				Thread Size	Thread Type	Standard Pack Quantity
		D	H	d1	h1			
491355	1	40.0	24.0	14.0	8.2	M6	Blind	10
491356	1	40.0	24.0	14.0	8.2	M8	Blind	10
491357	1	50.0	31.0	18.0	9.8	M10	Blind	5
491358	1	50.0	31.0	18.0	9.8	M8	Blind	5
491359	1	60.0	39.0	20.0	14.3	M10	Blind	5
491360	1	60.0	39.0	20.0	14.3	M12	Blind	5
491361	2	40.0	24.0	14.0	8.2	M6	Tapped Through	10
491362	2	40.0	24.0	14.0	8.2	M8	Tapped Through	10
491363	2	50.0	30.0	18.0	9.8	M8	Tapped Through	5
491364	2	50.0	30.0	18.0	9.8	M10	Tapped Through	5
491365	2	60.0	39.0	20.0	14.3	M10	Tapped Through	5
491366	2	60.0	39.0	20.0	14.3	M12	Tapped Through	5

Waist Shaped Knobs

SR 6526

Available in Steel And Stainless Steel

- Both male and female version available
- A compact and timeless design
- High grade stainless steel making it first choice when a high standard of hygiene is critical for application

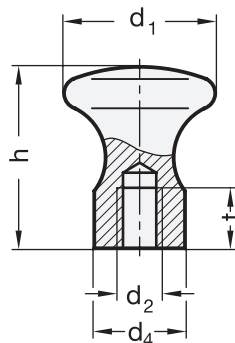

Type 1

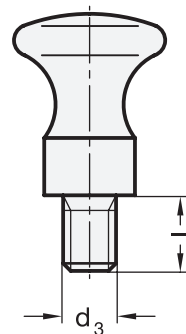

Type 2

Steel, Zinc Plated

Part Number	Type	Finish	Dimensions							Standard Pack Quantity
			h	d1	d2	d3	d4	l	t	
1337504	1	Blackened	18	16	M5	-	10	-	7	1
1337505	2	Blackened	18	16	-	M6	10	10	-	1
1337506	1	Blackened	24	20	M6	-	12	-	9	1
1337507	2	Blackened	24	20	-	M8	12	12	-	1
1337508	1	Blackened	29	25	M6	-	14	-	9	1
1337509	2	Blackened	29	25	-	M8	14	14	-	1
1337510	1	Blackened	37	32	-	M10	18	16	-	1
1337511	2	Blackened	37	32	M8	-	18	-	12	1
1337512	1	Blackened	42	36	M10	-	20	-	15	1
1337513	2	Blackened	42	36	-	M12	20	18	-	1

Stainless Steel

Part Number	Type	Finish	Dimensions							Standard Pack Quantity
			h	d1	d2	d3	d4	l	t	
1337514	1	Matte shot-blasted	18	16	M5	-	10	-	7	5
1337515	2	Matte shot-blasted	18	16	-	M6	10	10	-	5
1337516	1	Matte shot-blasted	24	20	M6	-	12	-	9	5
1337517	2	Matte shot-blasted	24	20	-	M8	12	12	-	5
1337518	1	Matte shot-blasted	29	25	M6	-	14	-	9	5
1337519	2	Matte shot-blasted	29	25	-	M8	14	14	-	5
1337520	1	Matte shot-blasted	37	32	-	M10	18	16	-	5
1337521	2	Matte shot-blasted	37	32	M8	-	18	-	12	5
1337522	1	Matte shot-blasted	42	36	M10	-	20	-	15	5
1337523	2	Matte shot-blasted	42	36	-	M12	20	18	-	5

Ball Knobs

SR 1535

Black LDPE

- Simple knock-on fixing for quick assembly

Part Number	Dimensions (mm)		Standard Pack Quantity
	D	d	
3209BLACK	12	3.2	10000
3212BLACK	12	4.0	10000
3214BLACK	12	4.8	10000
3219BLACK	12	6.0	10000
3220BLACK	12	6.4	10000
3314BLACK	15	4.8	5000
3320BLACK	15	6.4	5000
3614BLACK	25	4.8	1250
3619BLACK	25	6.0	1250
3620BLACK	25	6.4	1250
3624BLACK	25	7.9	1250
3628BLACK	25	9.5	1250
3720BLACK	30	6.4	625
3724BLACK	30	7.9	625
3728BLACK	30	9.5	625
3731BLACK	30	12.7	625
3732BLACK	30	15.9	625
3828BLACK	36	9.5	325
3831BLACK	36	12.7	700
3832BLACK	36	15.9	350
3835BLACK	36	19.1	350

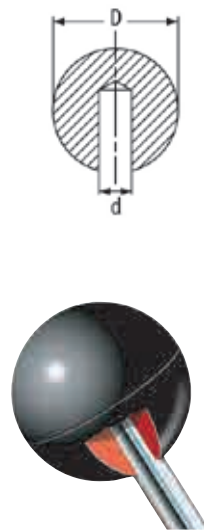

Phenolic Ball Knobs

SR 1535

Black Phenolic

- Durable, attractive gloss finish
- Type 1 – threaded to accept threaded stud
- Type 2 – simple knock-on assembly, reducing application time

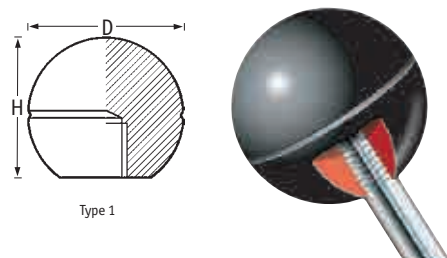

Type 1

Threaded Insert (Type 1)

Part Number	Dimensions (mm)		Thread Size	Standard Pack Quantity
	D	H		
462096	20	20	M8	500
107062569915	25	23	M6	250
462097	25	25	M10	250
462098	32	32	M6	200
462099	32	32	M10	200
462100	32	32	M12	200
462101	40	36	M8	100
1255004	40	40	M10	250
462103	40	40	M12	100
460606	44	43	M16	125

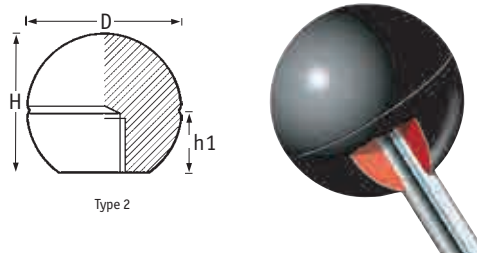

Type 2

Knock-On Assembly (Type 2)

Part Number	Dimensions (mm)			To fit shaft diameter (mm)	Standard Pack Quantity
	D	H	h1		
460607	19	17	13	5	250
460608	25	23	16	6	250
460609	32	30	15	8	250

HANDWHEELS AND KNOBS

Balls Knobs

SR 6528

Black Phenolic

Brass Insert



Part Number	Diameter (mm)	Thread Size	Thread Depth (mm)	Standard Pack Quantity
MBK-3	25.0	M8 x 1.25	11.0	1
MBK-1	25.0	M5 x 0.8	10.0	1
MBK-2	25.0	M6 x 1.00	11.0	1
MBK-7	35.0	M10 x 1.50	15.0	1
MBK-8	35.0	M12 x 1.75	17.0	1
MBK-5	35.0	M6 x 1.00	11.0	1
MBK-6	35.0	M8 x 1.25	11.0	1
MBK-10	48.0	M12 x 1.75	17.0	1
MBK-11	48.0	M16 x 2.0	18.0	1
MBK-9	48.0	M10 x 1.50	15.0	1

Balls Knobs

SR 6529

Black Thermoplastic



Part Number	Type	Diameter (mm)	Thread Size	Thread Depth (mm)	Standard Pack Quantity
RST-1	Molded Thread	16.0	M4	6.0	1
RST-2	Molded Thread	20.0	M5	8.0	1
RST-4	Molded Thread	30.0	M8	14.0	1
RST-5	Molded Thread	35.0	M10	16.0	1
RST-6	Molded Thread	40.0	M10	16.0	1
RST-7	Molded Thread	45.0	M12	9.0	1
RST-8	Molded Thread	50.0	M12	18.0	1
RST-9	Brass Insert	16.0	M4	6.0	1
RST-10	Brass Insert	20.0	M5	9.0	1
RST-11	Brass Insert	25.0	M6	10.0	1
RST-12	Brass Insert	30.0	M8	14.0	1
RST-13	Brass Insert	35.0	M10	17.0	1
RST-14	Brass Insert	40.0	M10	17.0	1

Mushroom Knobs

SR 6530

Black Phenolic

Brass Insert

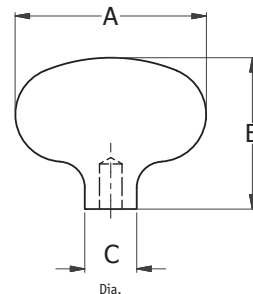

Part Number	Dimensions (mm)			Thread Size	Standard Pack Quantity
	A	B	C		
MLO-1	51.6	38.1	19.05	M6 x 1.0 x 11	1
MLO-2	51.6	38.1	19.05	M8 x 1.25 x 11	1
MLO-3	51.6	38.1	19.05	M10 x 1.5 x 13	1
MLO-4	51.6	38.1	19.05	M12 x 1.75 x 17	1

Aluminium Ball Knobs

SR 5485

Aluminium

- Polished Aluminium - DIN 319
- Type 1 - threaded to accept threaded stud
- Type 2 - simple knock-on assembly, reducing application time

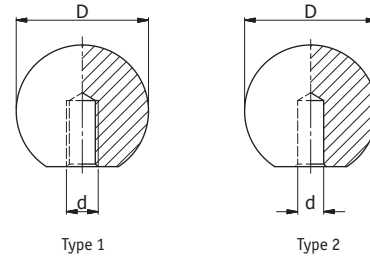

Part Number	Type	Dimensions (mm) D	Thread Size d	Standard Pack Quantity
498448	1	16	M4	10
498449	1	16	M5	10
498450	1	16	M6	10
498451	1	20	M4	10
498452	1	20	M5	10
498453	1	20	M6	10
498454	1	25	M6	10
498455	1	25	M8	10
498456	1	25	M10	10
498457	1	32	M6	10
498458	1	32	M8	10
498459	1	32	M10	10
498460	1	38	M6	10

Part Number	Type	Dimensions (mm) D	Thread Size d	Standard Pack Quantity
498461	1	38	M8	10
498462	1	38	M10	10
498463	1	44	M10	10
498464	1	50	M10	10
498477	2	16	4mm H7	10
498479	2	20	5mm H7	10
498483	2	32	6mm H7	10

Stainless Steel Ball Knobs

SR 5484

Stainless Steel

- Ideal for corrosion-free applications
- Highly polished with a flash chrome finish
- Type 1 - threaded to accept threaded stud
- Type 2 - simple knock-on assembly, reducing application time

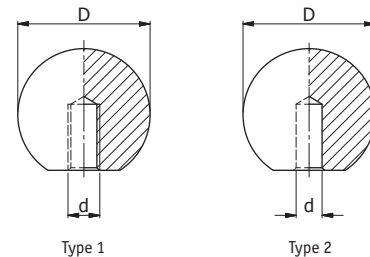

Part Number	Type	Dimensions (mm) D	Thread Size d	Standard Pack Quantity
498431	1	16	M4	10
498432	1	16	M5	10
498433	1	16	M6	10
498434	1	20	M4	10
498435	1	20	M5	10
498436	1	20	M6	10
498437	1	25	M6	10
498438	1	25	M8	10
498439	1	25	M10	10
498440	1	32	M6	10
498441	1	32	M8	10
498442	1	32	M10	10
498443	1	38	M6	10
498444	1	38	M8	10
498445	1	38	M10	10

Part Number	Type	Dimensions (mm) D	Thread Size d	Standard Pack Quantity
498446	1	44	M10	10
498447	1	50	M10	10
498465	2	16	4mm H7	10
498470	2	25	8mm H7	10
498476	2	44	10mm H7	10

Wingnut with Threaded Through Insert

SR 6531

Reinforced Polyamide

- Black RAL 9011
- Alternative caps available on custom request

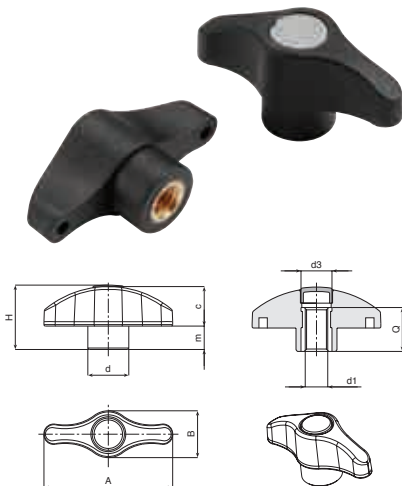

Part Number	Dimensions (mm)										Cap Colour	Standard Pack Quantity
	A	B	H	m	c	d	d3	d1	6H	Q		
1340362	44	16	22	8	14	14	10	M6	15	Grey	5	
1340363	52	19	26	9.5	16.5	17	13	M8	18	Grey	5	
1340364	52	19	26	9.5	16.5	17	13	M10	18	Grey	5	

Wingnut with Threaded Stud

SR 6532

Reinforced Polyamide

- Black RAL 9011
- Zinc Plated Steel Threaded Stud

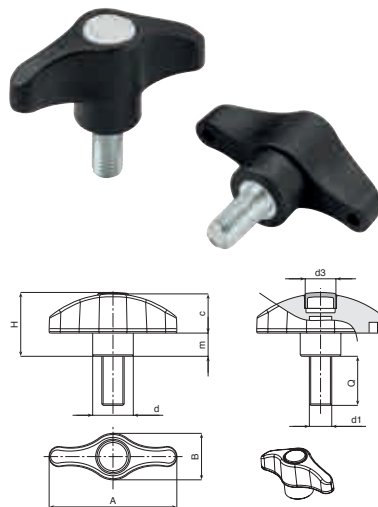

Part Number	Dimensions (mm)										Cap Colour	Standard Pack Quantity
	A	B	H	m	c	d	d3	d1	6H	Q		
1340359	44	16	22	8	14	14	10	M6	20	Grey	5	
1340360	52	19	26	9.5	16.5	17	13	M8	20	Grey	5	
1340361	67	24	32.5	11	21.5	21	16	M10	30	Grey	5	

Mushroom Knob with Threaded Insert

SR 6533

Reinforced Polyamide

- Black RAL 9011
- Brass Insert



Part Number	Dimensions (mm)						Standard Pack Quantity
	D	H	d	d1	Q		
1340365	22	17	11	M5	8	5	
1340366	22	17	11	M6	13	5	
1340367	32	24	15	M6	8	5	
1340368	32	24	15	M8	13	5	

Mushroom Knob with Threaded Stud

SR 6534

Reinforced Polyamide

- Black RAL 9011
- Zinc plated steel threaded stud



Part Number	Dimensions (mm)							Standard Pack Quantity
	D	H	d	LM	d1	6g	Q	
1340369	22	17	11	56	M5	30	1	
1340370	22	17	11	65	M6	30	1	
1340371	32	24	15	70	M6	30	1	
1340372	32	24	15	70	M8	40	1	

Stainless Steel Wing Nuts

SR 6535

Stainless Steel AISI CF-8 shot-blasted finish

- Stainless Steel Wing Nuts are manufactured by precision casting and therefore made out of one piece. Drilling and threading is processed subsequently
- Type 1: With threaded blind bore
- Type 2: With threaded through bore

Part Number	Type	Dimensions (mm)										Standard Pack Quantity
		d1	d2	d3	d4	b	h1	h2	t1(min.)	t2		
1220622	2	46	M6	13	6.5	6	22.5	6	12	10	10	
1220623	1	46	M6	13	6.5	6	22.5	6	12	10	10	
1220624	2	46	M8	13	8.5	6	22.5	6	15	13	10	
1220625	1	46	M8	13	8.5	6	22.5	6	15	13	10	
1220628	2	58	M8	16	8.5	7	26.5	7	15	13	10	
1220629	1	58	M8	16	8.5	7	26.5	7	15	13	10	
1220626	2	58	M10	16	10.5	7	26.5	7	18	16	10	
1220627	1	58	M10	16	10.5	7	26.5	7	18	16	10	

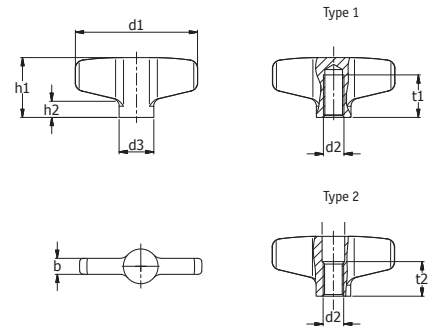

Stainless Steel Wing Screws

SR 6536

Stainless Steel AISI CF-8 shot-blasted finish

- Stainless Steel Wing Screws are manufactured by precision casting and therefore made out of one piece. The thread is being processed subsequently

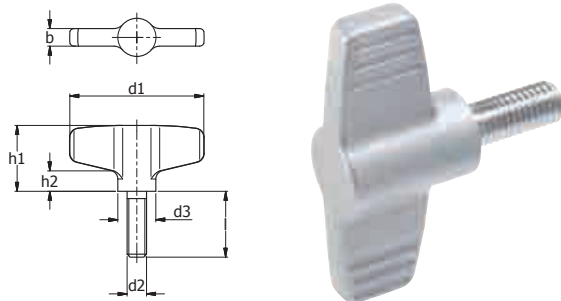

Part Number	Dimensions (mm)							Standard Pack Quantity
	d1	d2	Length l	d3	b	h1	h2	
1220630	46	M6	16	13	6	22.5	6	10
1220631	46	M6	20	13	6	22.5	6	10
1220632	46	M6	25	13	6	22.5	6	10
1220633	46	M8	16	13	6	22.5	6	10
1220634	46	M8	20	13	6	22.5	6	10
1220635	46	M8	25	13	6	22.5	6	10
1220639	58	M8	20	16	7	26.5	7	10
1220640	58	M8	25	16	7	26.5	7	10
1220641	58	M8	30	16	7	26.5	7	10
1220636	58	M10	20	16	7	26.5	7	10
1220637	58	M10	25	16	7	26.5	7	10
1220638	58	M10	30	16	7	26.5	7	10

Stainless Steel Wing Knobs

SR 5417

Stainless Steel – Matte Finish

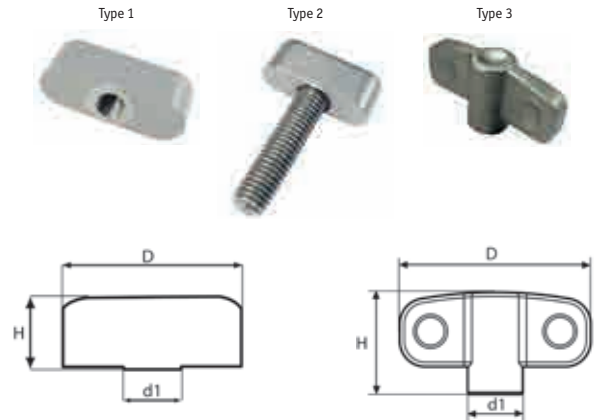

Part Number	Type	Dimensions (mm)			Thread Size	Thread Length (mm)	Thread Type	Standard Pack Quantity
		D	H	d1				
491368	1	25.0	10.0	8.0	M6	-	Female	10
491369	1	36.0	14.5	12.0	M8	-	Female	20
491370	2	25.0	10.0	8.0	M6	20	Male	10
491371	2	36.0	14.5	12.0	M8	32	Male	20
491372	2	36.0	14.5	12.0	M10	40	Male	20
491373	3	45.0	24.0	13.0	M6	-	Female	10
491374	3	45.0	24.0	13.0	M8	-	Female	10
491375	3	57.0	28.0	16.0	M8	-	Female	20
491376	3	57.0	28.0	16.0	M10	-	Female	20

HANDWHEELS AND KNOBS

Tapered Knobs

SR 1538

Black PA 6



- Durable with high impact resistance
- Type 1: simple knock-on assembly
- Type 2: moulded inner thread
- Resistant to oils, fuels and greases

Part Number		Dimensions			Thread or Bore	Standard Pack Quantity
Type 1	Type 2	D	H	d		
466377	466372	15	20	10	ø5, M5	500
466378	466373	18	25	12	ø6, M6	500
466379	466374	24	33	16	ø8, M8	500
466380	466375	28	38	18	ø10, M10	500
466381	466376	31	43	21	ø12, M12	500

Long Tapered Knobs

SR 1533

Black PA 6

- Male version: plated steel threaded stud for increased fixing security
- Female version: simple knock-on assembly onto plain shaft

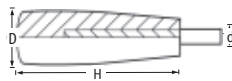

Male Version

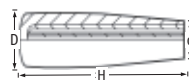

Female Version

Male

Part Number	Dimensions			Thread	Stud Length	Standard Pack Quantity
	D	H	d			
466332	18	40.1	15	M6	10	100
466333	21	50.0	17	M8	12	100
466334	23	65.0	19	M10	15	100
466336	28	90.0	22	M12	20	100

Female

Part Number	Dimensions				Bore Diameter	Standard Pack Quantity
	D	H	d	h		
466337	18	40	15	37	8	100
466338	21	50	17	46	10	100
466339	23	65	19	61	10	100
466340	26	80	21	75	12	100
466341	28	90	22	85	16	100

Tapered Handle with Threaded Hole or Threaded Stud

SR 6537

- Material - Phenolic based (PF) Duroplast Resistant to solvents, oils, greases and other chemical agents
- Colour - Black, glossy finish
- Type 1 - Tapered handle with threaded blind hole
- Type 2 - Tapered handle with zinc-plated steel threaded stud, chamfered flat end UNI 947 : ISO 4753



Type 1

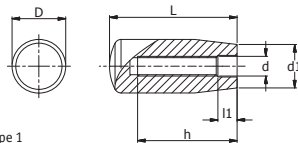

Type 2

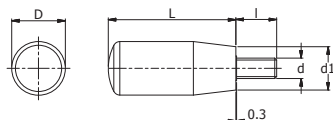

Part Number	Type	Dimensions (mm)				Mounting Hole		Weight (Grams)	Standard Pack Quantity
		L	D	d1	d	h	l1		
1219160	1	28	14	11	M5	12	1.5	5	50
1219162	1	40	18	15	M6	25	3.5	12	50
1219163	1	40	18	15	M8	25	3.5	12	50
1219165	1	50	21	17	M6	25	3.5	21	50
1219166	1	50	21	17	M8	35	7.5	20	50
1219171	1	65	23	19	M8	30	7.5	33	25
1219169	1	65	23	19	M10	40	7.5	30	25
1219170	1	65	23	19	M12	40	7.5	28	25
1219175	1	80	26	21	M8	45	8	45	10
1219173	1	80	26	21	M10	55	7	47	10
1219174	1	80	26	21	M12	55	10	45	10
1219177	1	90	28	22	M10	55	7	64	10
1219178	1	90	28	22	M12	58	8	62	10
1219157	1	102	31	25	M12	58	8	90	10
1219158	1	102	31	25	M14	65	5	85	10
1219159	1	116	29	23	M12	58	8	88	10

Part Number	Type	Dimensions (mm)				Threaded Stud		Weight (Grams)	Standard Pack Quantity
		L	D	d1	d6g	l			
1219161	2	40	18	15	M6	16	18	25	
1219164	2	50	21	17	M8	16	38	1	
1219167	2	65	23	19	M10	16	60	1	
1219168	2	65	23	19	M10	30	67	1	
1219172	2	80	26	21	M10	16	80	1	
1219176	2	90	28	22	M12	16	113	1	
1219156	2	102	31	25	M12	16	142	1	

Conical Handle with Threaded Hole

SR 6538

Black RAL 9011 PA

- Female threaded blind hole

Part Number	Dimensions					Standard Pack Quantity
	H	D	d	d1	Q	
1340344	50	20	15	M6	23	1
1340345	50	20	15	M8	23	1
1340346	50	20	15	M10	23	1
1340347	60	23	18	M8	30	1
1340348	60	23	18	M10	30	1
1340349	70	25	19	M8	30	1
1340350	70	25	19	M10	30	1
1340351	80	26	21	M12	31	1
1340352	80	26	21	M12	31	1

With Grey Cap

Part Number	Dimensions					Standard Pack Quantity
	H	D	d	h1	d1	
1340353	89.5	27	22	32	M8	1
1340354	89.5	27	22	32	M10	1



Conical Handle with Threaded Stud

SR 6539

Black RAL 9011 Reinforced polyamide

- Zinc plated Threaded Steel Stud
- Inserts available in different materials and lengths available through custom solution

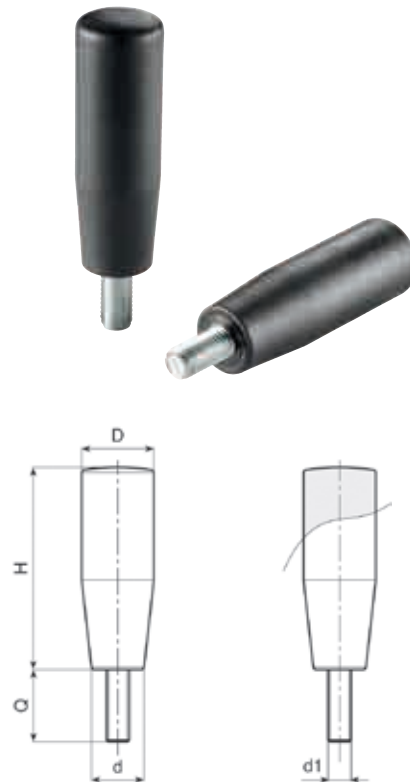

Part Number	Dimensions					Standard Pack Quantity
	H	D	d	d1	Q	
1340355	50	20	15	M 6	10	20
1340356	50	20	15	M 8	10	20
1340357	70	25	18	M 8	10	20
1340358	80	26	21	M 8	10	20

Tee Knobs

SR 1539

Black PA 6

- Male version: plated steel threaded stud
- Female version: brass insert



Male: Plated Steel Stud

Part Number	Dimensions (mm)					Thread	Stud Length (mm)	Standard Pack Quantity
	L	H	d	h1	W			
466367	40	30	13	20	13	M5	20	100
466368	50	25	14	16	16	M5	20	100
466369	60	32	16	23	18	M6	25	100
466370	71	34	18	19	19	M8	30	100
466371	80	40	26	26	27	M10	40	100

Female: Brass Insert

Part Number	Dimensions (mm)					Thread	Standard Pack Quantity
	L	H	d	h1	W		
466362	40	30	13	20	13	M5	100
466363	50	25	14	16	16	M5	100
466364	60	32	16	23	18	M6	100
466365	71	34	18	19	19	M8	100
466366	80	40	26	26	27	M10	100

Tee Handles

SR 6540

- Material - Glass-fibre reinforced polyamide based (PA) technopolymer. Resistant to solvents, oils, greases and other chemical agents
- Colour - Black colour, matte finish
- Type 1 - Brass boss, threaded blind hole
- Type 2 - Zinc-plated steel threaded stud, chamfered flat end
UNI 947: ISO 4753



Type 1

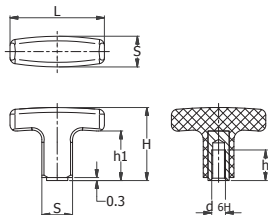

Type 2

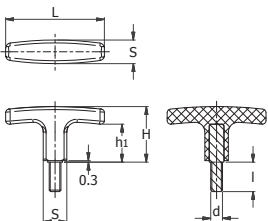

Part Number	Type	Dimensions (mm)				Mounting Hole		Weight (Grams)	Standard Pack Quantity
		L	S	H	h1	d6H	h		
1219179	1	40	13	30	20	M6	16	10	
1219181	1	55	15	33	22	M6	18	10	
1219182	1	55	15	33	22	M8	20	10	
1219184	1	67	16.5	37	25	M8	20	10	
1219188	1	80	20	41	26	M8	25	10	
1219186	1	80	20	41	26	M10	25	10	
1219187	1	80	20	41	26	M12	18	10	
1219191	1	94	21	46	28.5	M10	25	1	
1219192	1	94	21	46	28.5	M12	18	1	

Part Number	Type	Dimensions (mm)				Threaded Stud		Weight (Grams)	Standard Pack Quantity
		L	S	H	h1	d6g	l		
1219180	2	40	13	30	20	M6	20	17	1
1219183	2	55	14	33	22	M8	20	28	1
1219185	2	67	16	37	25	M8	25	38	1
1219189	2	80	20	41	26	M10	20	52	1
1219190	2	80	20	41	26	M10	30	58	1
1219193	2	94	21	46	28.5	M12	30	68	1

Knobs for Socket Head Cap Screw

SR 1537

Black PA 6

- Easy assembly of socket head cap screw into base of knob
- No special tools or glue necessary
- Type 1: T-head provides extra leverage
- Type 2: Knurled edge for increased grip



Type 1



Type 2

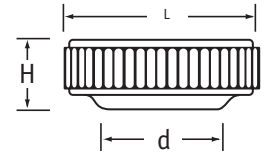
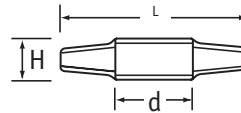

Tee Knob (Type 1)

Part Number	Dimensions (mm)			To fit socket head cap screw	Standard Pack Quantity
	L	H	d		
466354	30	8	13	M6	500
466355	38	10	17	M8	500

Knurled Knob (Type 2)

Part Number	Dimensions (mm)			To fit socket head cap screw	Standard Pack Quantity
	L	H	d		
466350	13	5	10	M4	500
466351	16	6	12	M5	500
466352	19	8	14	M6	500

Wing Knobs

SR 1579

Black PA

- Zinc-plated steel threaded studs for strength
- Provide a simple means of adjusting and fixing
- Ideal for use in shopfitting and point-of-sale applications

Part Number	Dimensions (mm)		Thread Size	Standard Pack Quantity
	Wing	Stud Length		
KTSW-28M05M15	28	15	M5	500
KTSW-28M05M25	28	25	M5	500
KTSW-28M06M10	28	10	M6	500
KTSW-28M06M25	28	25	M6	500
KTSW-33M08M25	33	25	M8	300



Wing Knob

SR 6123

Black Polyamide

- Glass-fibre reinforced polyamide based technopolymer
- Brass female insert or zinc plated steel stud
- Protruding 0.3 mm metal shoulder ensures a metal-to-metal assembly
- Resistant to solvents, oils, greases and other chemical agents



Part Number	Dimensions (mm)						Standard Pack Quantity
	Thread (A)	B	C	D	E	F	
259052559935	M5	6	11	26	13	F1	10
259063059935	M6	8	13	32	15	F1	10
259084059935	M8	8	15.5	40	17	F1	10
259040659935	M4	6	9.5	20	11	F2	10
259041059935	M4	10	9.5	20	11	F2	10
259051059935	M5	10	11	26	13	F2	10
259051659935	M5	16	11	26	13	F2	10
259061059935	M6	10	13	32	15	F2	10
259061659935	M6	16	13	32	15	F2	10
259062059935	M6	20	13	32	15	F2	10

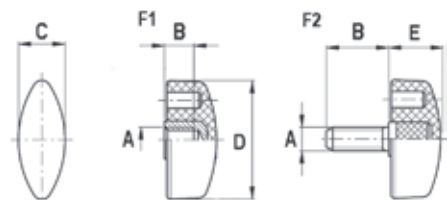

HANDWHEELS AND KNOBS

Fixed Level with Threaded Insert

SR 6541
PA 6

- Special high resistant glass fiber reinforced technopolymer
- Black RAL 9011 - Central cap Grey polyamide RAL 7035
- A various offer of colour caps available on custom request

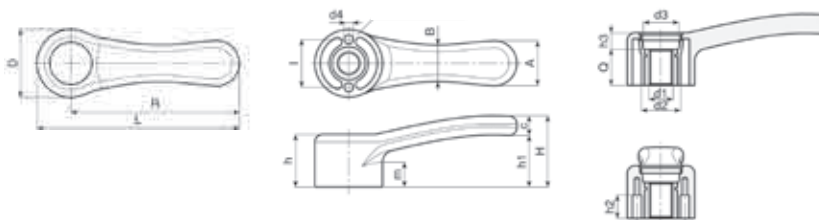

Part Number	Colour	Cap	Dimensions																	Standard Pack Quantity	
			L	R	D	H	h	h1	h2	h3	m	l	A	b	c	d2	d3	d4	d1 6H		Q
1340331	Black	Grey	84.5	68	33	37	25	27	11.5	9	12	24	20	17	10	20	16	4	M 8	16	10
1340332	Black	Grey	84.5	68	33	37	25	27	11.5	9	12	24	20	17	10	20	16	4	M 20	16	10
1340333	Black	Grey	104	89	36	40	28	29	14	12	13	26	24	19	11	22	18	5	M 8	16	10
1340334	Black	Grey	104	86	36	40	28	29	14	12	13	26	24	19	11	22	18	5	M 10	16	10
1340335	Black	Grey	112	45	47	36	35	14.5	12	16	32	30	24	13	13	26	23.5	6	m 12	24	10

Fixed Level with smooth Insert

SR 6542
PA 6

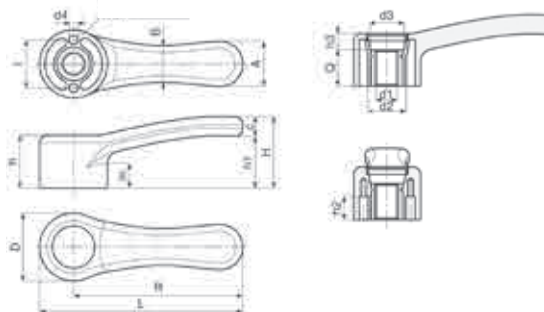

Part Number	Colour	Cap	Dimensions																	Standard Pack Quantity		
			L	R	D	H	h	h1	h2	h3	m	l	A	b	c	d2	d3	d4	dm		d1 6H	Q
1340336	Black	Grey	84.5	68	33	37	25	27	11.5	9	12	24	20	17	10	20	16	4	10	05	16	10
1340337	Black	Grey	84.5	68	33	37	25	27	11.5	9	12	24	20	17	10	20	16	4	10	10	16	10
1340338	Black	Grey	104	86	36	40	28	29	14	12	13	26	24	19	11	22	18	5	12	05	16	10
1340339	Black	Grey	104	86	36	40	28	29	14	12	13	26	24	19	11	22	18	5	12	10	16	10
1340340	Black	Grey	112	86	36	40	28	29	14	12	13	26	24	19	11	22	18	5	12	05	16	10
1340341	Black	Grey	112	86	36	40	28	29	14	12	13	26	24	19	11	22	18	5	12	10	16	10

Revolving folding hand with stainless steel base

SR 6543
Stainless Steel

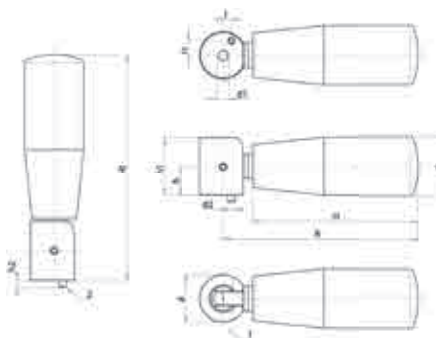

Part Number	Dimensions												Standard Pack Quantity
	H	D	d	R	Ht	h	h1	h2	d1	d2	l	l1	
1340342	70	25	20	82.5	96	12.5	25	3	M 5	3	3.5	6.1	5
1340343	80	25	20	82.5	96	12.5	25	3	M 5	3	3.5	6.1	5

Three Arm Handwheel

SR 6544

PA

- Reinforced and stabilised polyamide. Oils and grease resistant
- Black RAL 9011 - Central cap Grey polyamide RAL 7035
- A range of colour caps available on custom request

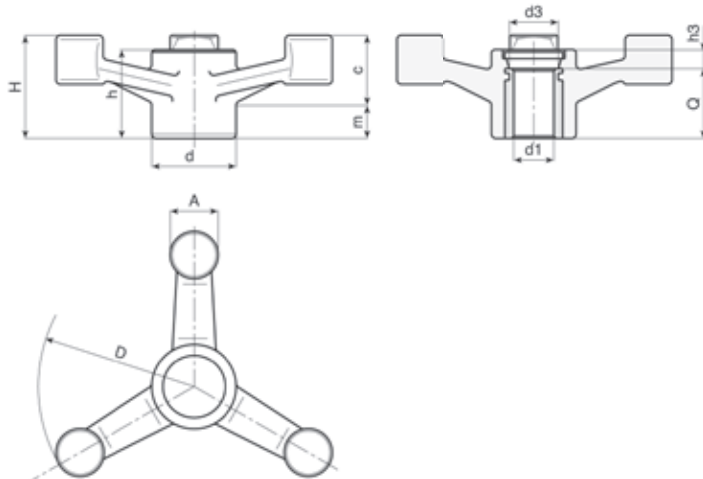

Part Number	Colour	Cap	Dimensions												Standard Pack Quantity
			D	H	h	d	m	c	A	h3	d3	d1 H10	Q		
1340326	Black	Grey	137	45	39.5	38	19	26	22	7.5	26	8	32	1	
1340327	Black	Grey	177	56	42.5	38	20	35	23	10.5	26	8	32	1	
1340328	Black	Grey	137	45	39.5	38	19	26	22	7.5	26	M 12	32	1	
1340329	Black	Grey	177	56	42.5	38	20	35	23	10.5	26	M 16	8.5	1	

Four Arm Handwheel

SR 6545

PA

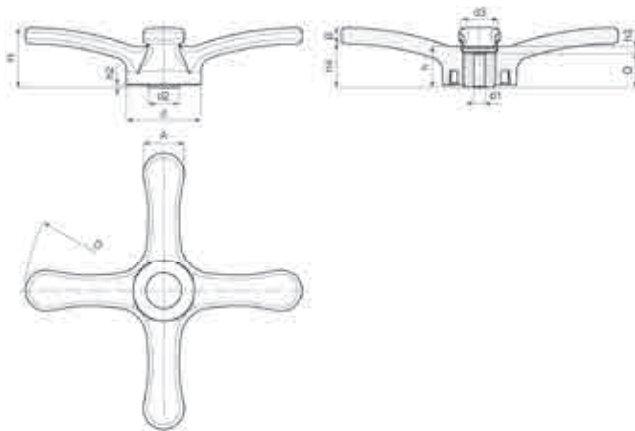

Part Number	Colour	Cap	Dimensions													Standard Pack Quantity	
			D	H	h	d	d2	A	B	h2	h3	h4	d3	Dm	d1H10		Q
1340330	Black	Grey	308	66	45.5	83	35.5	45.5	20	3	7.5	46	34	26	8	38	1

CONTROL WHEELS

Shaft with Ball Knob

SR N-0000

Steel

- Shafts are ground and polished with black oxide finish
- Knobs are black plastic with brass inserts

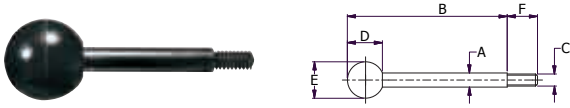

Part Number	Dimensions (mm)						Standard Pack Quantity
	A	B	C	D	E	F	
WGL-0	0.32	2.48	M6 x 1.0	0.71	0.79	0.35	10
WGL-5	0.32	3.15	M6 x 1.0	0.71	0.79	0.35	10
WGL-10	0.32	3.94	M6 x 1.0	0.71	0.79	0.35	10
WGL-15	0.39	3.15	M8 x 1.25	0.89	0.98	0.43	10
WGL-20	0.39	3.94	M8 x 1.25	0.89	0.98	0.43	10
WGL-25	0.39	4.92	M8 x 1.25	0.89	0.98	0.43	10
WGL-30	0.47	3.94	M10 x 1.5	1.14	1.26	0.55	10
WGL-35	0.47	4.92	M10 x 1.5	1.14	1.26	0.55	10
WGL-40	0.47	6.30	M10 x 1.5	1.14	1.26	0.55	10
WGL-45	0.55	4.92	M12 x 1.75	1.28	1.38	0.63	10
WGL-50	0.55	6.30	M12 x 1.75	1.28	1.38	0.63	10
WGL-55	0.55	7.87	M12 x 1.75	1.28	1.38	0.63	10
WGL-60	0.63	6.30	M14 x 2.0	1.46	1.57	0.71	10
WGL-70	0.63	9.84	M14 x 2.0	1.46	1.57	0.71	10

Shaft with Handle

SR N-0001

Steel

- Shafts are ground and polished with black oxide finish
- Knobs are black plastic with brass inserts

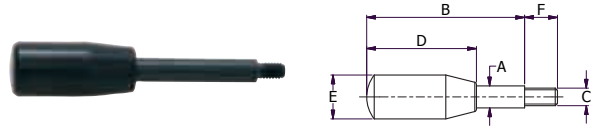

Part Number	Dimensions (mm)						Standard Pack Quantity
	A	B	C	D	E	F	
WGL-150	0.32	2.48	M6 x 1.0	1.57	0.71	0.35	10
WGL-155	0.32	3.15	M6 x 1.0	1.57	0.71	0.35	10
WGL-160	0.32	3.94	M6 x 1.0	1.57	0.71	0.35	10
WGL-165	0.39	3.15	M8 x 1.25	1.97	0.83	0.43	10
WGL-170	0.39	3.94	M8 x 1.25	1.97	0.83	0.43	10
WGL-175	0.39	4.92	M8 x 1.25	1.97	0.83	0.43	10
WGL-180	0.47	3.94	M10 x 1.5	2.56	0.91	0.55	10
WGL-185	0.47	4.92	M10 x 1.5	2.56	0.91	0.55	10
WGL-190	0.47	6.30	M10 x 1.5	2.56	0.91	0.55	10
WGL-195	0.55	4.92	M12 x 1.75	3.15	1.02	0.63	10
WGL-200	0.55	6.30	M12 x 1.75	3.15	1.02	0.63	10
WGL-205	0.55	7.87	M12 x 1.75	3.15	1.02	0.63	10
WGL-210	0.63	6.30	M14 x 2.0	3.54	1.10	0.71	10
WGL-220	0.63	9.84	M14 x 2.0	3.54	1.10	0.71	10

Shaft with Tapered Knob

SR N-0002

Steel

- Shafts are ground and polished with black oxide finish
- Knobs are black plastic with brass inserts

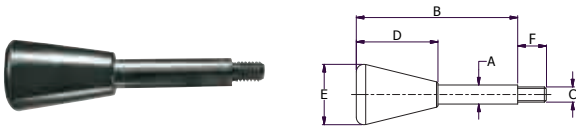

Part Number	Dimensions (mm)						Standard Pack Quantity
	A	B	C	D	E	F	
WGL-75	0.32	2.48	M6 x 1.0	1.18	0.79	0.35	10
WGL-80	0.32	3.15	M6 x 1.0	1.18	0.79	0.35	10
WGL-85	0.32	3.94	M6 x 1.0	1.18	0.79	0.35	10
WGL-90	0.39	3.15	M8 x 1.25	1.50	0.98	0.43	10
WGL-95	0.39	3.94	M8 x 1.25	1.50	0.98	0.43	10
WGL-100	0.39	4.92	M8 x 1.25	1.50	0.98	0.43	10
WGL-105	0.47	3.94	M10 x 1.5	1.81	1.18	0.55	10
WGL-115	0.47	6.30	M10 x 1.5	1.81	1.18	0.55	10
WGL-120	0.55	4.92	M12 x 1.75	2.09	1.38	0.63	10
WGL-125	0.55	6.30	M12 x 1.75	2.09	1.38	0.63	10
WGL-130	0.55	7.87	M12 x 1.75	2.09	1.38	0.63	10
WGL-145	0.63	9.84	M14 x 2.0	2.09	1.38	0.71	10

Shaft

SR N-0003

Steel

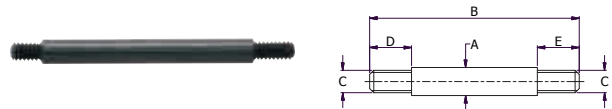

Part Number	Dimensions (mm)					Standard Pack Quantity
	A	B	C	D	E	
GLS-130	0.312	2.5	M6 x 1.0	0.50	0.375	50
GLS-135	0.312	3.5	M6 x 1.0	0.50	0.375	50
GLS-140	0.312	5.0	M6 x 1.0	0.50	0.375	50
GLS-145	0.375	2.5	M8 x 1.25	0.50	0.375	50
GLS-155	0.375	5.0	M8 x 1.25	0.50	0.375	50
GLS-160	0.438	3.0	M10 x 1.5	0.50	0.375	50
GLS-170	0.438	6.0	M10 x 1.5	0.75	0.375	50
GLS-180	0.563	6.0	M12 x 1.75	0.75	0.500	50
GLS-185	0.563	8.0	M12 x 1.75	1.00	0.500	50

Control Knobs

SR 6546

Anodized Black

- Made from an aluminium extrusion
- Cover cap with indicator, or logo available on custom design
- Stainless Steel - Grub Screw DIN 916 with internal hexagon and serrated point

Part Number	Dimensions									Standard Pack Quantity
	d1	d2 H8 Bore	d4	d5	d6	h1	h2	h3	t	
1337433	22	B5	16	14	M4	15	9	4.3	-	1
1337434	27	B5	20	18	M4	17	11	4.3	14	1
1337435	34	B8	65	23	M5	20	14	4.2	17	1
1337436	42	B10	32	30	M5	23	17	4	20	1

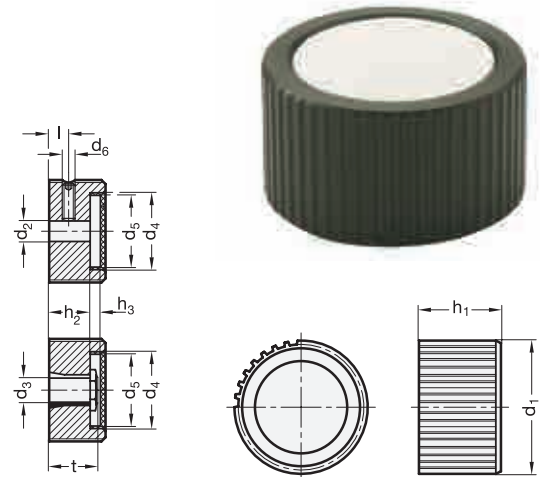

2-Spoked Plastic Handwheels

SR 5412

Black High Impact Resistant PA

- Plated steel insert
- Matte black finished
- Resistant to oils and greases

Part Number	Type	Pilot Bore Size (mm)	Maximum Bore Size (mm)	Dimensions					Standard Pack Quantity	
				D	d1	h1	h2	h3		h4
491297	1	5	16	100	28	44	16	33	-	2
491298	1	5	16	130	32	50	20	35	-	2
491299	1	5	20	160	40	56	24	40	-	1
491300	1	5	20	200	50	61	28	40	-	1
491302	2	5	16	100	28	44	56	16	33	2
491303	2	5	16	130	32	50	66	20	35	2
491304	2	5	20	160	40	56	76	24	40	1
491305	2	5	20	200	50	61	76	28	40	1



Type 1: Without Handle



Type 2: With Handle

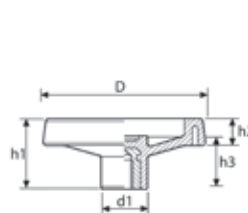

Type 1: Without Handle

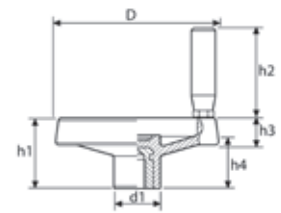

Type 2: With Handle

Solid Plastic Handwheels

SR 5413

Black High Impact Resistant PA

- Plated steel insert
- Matte black finished
- Resistant to oils and greases

Part Number	Type	Pilot Bore Size (mm)	Maximum Bore Size (mm)	Dimensions					Standard Pack Quantity	
				D	d1	h1	h2	h3		h4
491287	1	8	16	100	30	39	54	21	34	2
491289	1	8	20	150	38	53	76	29	44	2
491291	1	8	20	200	44	61	86	35	51	1
491292	2	8	16	100	30	39	54	21	34	2
491294	2	8	20	150	38	53	98	29	44	2
491296	2	8	20	200	44	61	98	35	51	1



Type 1: With Upright Handle



Type 2: With Folding Handle

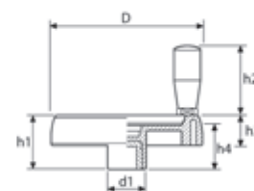

CONTROL WHEELS

Metal Control Handwheels

SR 5411

Stainless Steel, Aluminium or Black Coated Steel

- Suited to heavier industrial purposes and outdoor use
- Type 2 & 3: Pressed steel construction
- Supplied for keyway fitting



Type 1

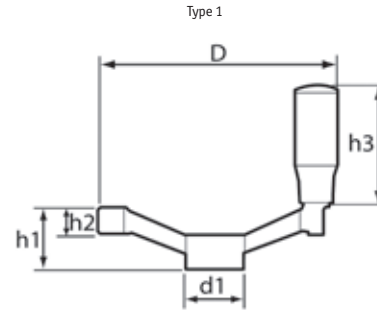

Type 2

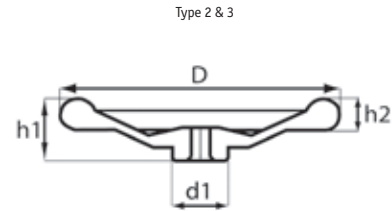

Type 2 & 3



Type 3

Part Number	Type	Dimensions (mm)						Material	Standard Pack Quantity
		Bore Diameter	D	h1	d1	h2	h3		
491276	1	12	125	33	31	15.0	65	Aluminium	2
491277	1	14	140	36	36	16.5	65	Aluminium	2
491278	1	14	160	39	36	18.0	96	Aluminium	1
491279	1	18	200	45	42	20.5	96	Aluminium	1
491280	2	11	125	31	30	16.0	-	Black Coated Steel	2
491282	2	14	200	42	40	26.0	-	Black Coated Steel	1
491283	2	17	250	47	45	30.0	-	Black Coated Steel	1
491285	3	14	200	41	40	25.0	-	Stainless Steel	1
491286	3	17	250	48	45	30.0	-	Stainless Steel	1

Two Spoked Technopolymer Handwheels

SR 6547

Black PP

- All Types are Spoked Handwheel with Black-oxide steel boss, H7 reamed hole
- Type 1 - Spoked Handwheel without handle
- Type 2 - Spoked Handwheel with revolving handle
- Type 3 - Spoked Handwheel with fold-away handle

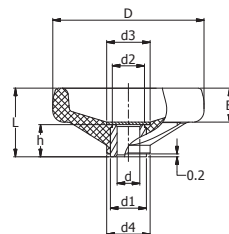

Type 1

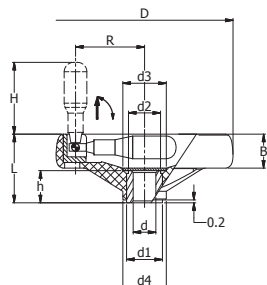

Type 3

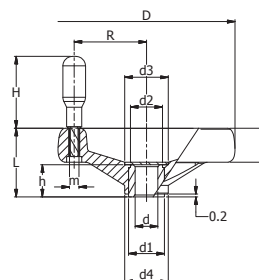

Type 2



Part Number	Type	Dimensions (mm)							Bore		Weight (Grams)	Standard Pack Quantity
		D	L	B	d1	d2	d3	d4	dH7	h		
1219228	1	80	35	18	18	16	20.5	25	8	17	74	1
1219227	1	80	35	18	18	16	20.5	25	10	17	70	1
1219197	1	99	37	20	18	16	20.5	25.5	12	17	95	1
1219202	1	125	44	22	22	20	26	31	12	22	160	1
1219203	1	125	44	22	22	20	26	31	14	22	155	1
1219207	1	160	51	25	26	24	31	40	14	27	275	1
1219208	1	160	51	25	26	24	31	40	16	27	263	1
1219212	1	200	61	28	30	28	36	50	20	34	430	1
1219216	1	250	69	32	35	33	44	57	24	38	710	1
1219219	1	300	78	35.5	40	37	55	66	20	43	940	1
1219220	1	300	78	35.5	40	37	55	66	26	43	970	1
1219223	1	375	87	39	35	33	70	81	26	43	1350	1

Part Number	Type	Dimensions (mm)							Bore		Handle			Weight (Grams)	Standard Pack Quantity
		D	L	B	d1	d2	d3	d4	dH7	h	H	m	R		
1219224	2	80	35	18	18	16	20.5	23.5	8	17	45	M6	29	104	1
1219194	2	99	37	20	18	16	20.5	25.5	10	17	60	M6	37	145	1
1219198	2	125	44	22	22	20	26	31	12	22	65	M8	48	245	1
1219199	2	125	44	22	22	20	26	31	14	22	65	M8	48	240	1
1219204	2	160	51	25	26	24	31	40	16	27	80	M8	65	339	1
1219209	2	200	61	28	30	28	36	50	20	34	80	M8	84	525	1
1219213	2	250	69	32	35	33	44	57	20	38	90	M10	105	904	1
1219214	2	250	69	32	35	33	44	57	24	38	90	M10	105	888	1
1219217	2	300	78	35.5	40	37	55	66	26	43	90	M10	123	1111	1
1219221	2	375	87	39	35	33	70	81	26	43	90	M10	160	1240	1

Part Number	Type	Dimensions (mm)							Bore		Handle		Weight (Grams)	Standard Pack Quantity
		D	L	B	d1	d2	d3	d4	dH7	h	H	R		
1219226	3	80	35	18	18	16	20.5	25	8	17	45	29	102	1
1219225	3	80	35	18	18	16	20.5	25	10	17	45	29	98	1
1219195	3	99	37	20	18	16	20.5	25.5	10	17	60	37	163	1
1219196	3	99	37	20	18	16	20.5	25.5	12	17	60	37	155	1
1219200	3	125	44	22	22	20	26	31	12	22	65	48	230	1
1219201	3	125	44	22	22	20	26	31	14	22	65	48	225	1
1219205	3	160	51	25	26	24	31	40	14	27	80	65	388	1
1219206	3	160	51	25	26	24	31	40	16	27	80	65	380	1
1219211	3	200	61	28	30	28	36	50	8	34	80	84	625	1
1219210	3	200	61	28	30	28	36	50	20	34	80	84	560	1
1219215	3	250	69	32	35	33	44	57	24	38	90	105	892	1
1219218	3	300	78	35.5	40	37	55	66	26	43	90	123	1210	1
1219222	3	375	87	39	35	33	70	81	26	43	90	160	1350	1

CONTROL WHEEL ACCESSORIES

Revolving – Wrench Flats

SR 6552

Black Thermoplastic

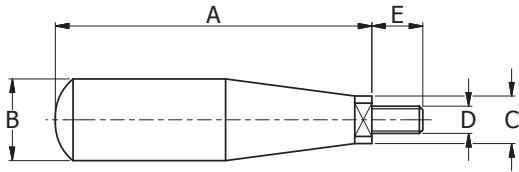

Part Number	Dimensions (mm)					Standard Pack Quantity
	A	B	C	D	E	
JCL-850	55.0	20.0	12.0	M6 x 1	12.0	10
JCL-855	67.0	23.0	18.0	M8 x 1.25	15.0	10
JCL-860	77.0	25.0	18.0	M8 x 1.25	15.0	10
JCL-865	77.0	25.0	18.0	M10 x 1.5	15.0	10
JCL-870	87.0	27.0	20.0	M10 x 1.5	15.0	10
JCL-875	87.0	27.0	20.0	M12 x 1.75	15.0	10
JCL-880	97.0	29.0	20.0	M10 x 1.5	15.0	10
JCL-885	97.0	29.0	20.0	M12 x 1.75	15.0	10

Revolving and Folding – Straight

SR 6553

Black Thermoplastic

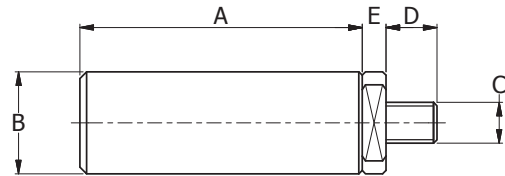

Part Number	Dimensions (mm)					Standard Pack Quantity
	A	B	C	D	E	
JCL-900	82.0	25.0	M10 x 1.5	17.0	7.5	10
JCL-905	90.0	25.0	M10 x 1.5	17.0	7.5	10

Revolving – Internal Hex

SR 6554

Black Thermoplastic

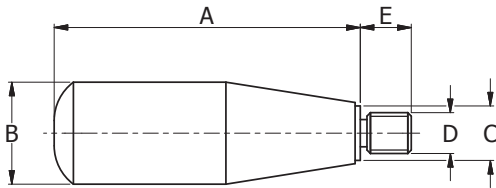

Part Number	Dimensions (mm)						Standard Pack Quantity
	A	B	C	D	E	Hex	
JCL-930	52.0	20.0	11.0	M6 x 1	12.0	3.0	10
JCL-935	62.0	23.0	14.0	M6 x 1	15.0	4.0	10
JCL-940	62.0	23.0	14.0	M8 x 1.25	15.0	4.0	10
JCL-945	72.0	25.0	14.0	M8 x 1.25	15.0	4.5	10
JCL-950	72.0	25.0	14.0	M10 x 1.5	15.0	4.5	10
JCL-955	82.0	26.0	14.0	M10 x 1.5	15.0	5.0	10
JCL-960	82.0	26.0	14.0	M12 x 1.75	15.0	5.0	10
JCL-965	92.0	28.0	14.0	M10 x 1.5	15.0	6.0	10
JCL-970	92.0	28.0	14.0	M12 x 1.75	15.0	6.0	10

Revolving and Folding – Conical

SR 6555

Black Thermoplastic

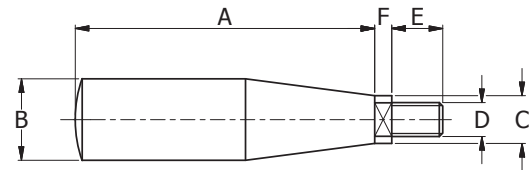

Part Number	Dimensions (mm)						Standard Pack Quantity
	A	B	C	D	E	F	
JCL-890	50.0	20.0	14.0	M6 x 1	9.0	6.0	10
JCL-895	70.0	25.0	20.0	M8 x 1.25	16.0	6.5	10

Crank Handles with Revolving and Folding Handles

SR 6556

Black PA, matte finish

- Type 1 - Crank handle with revolving handle. Black-oxide steel hub, H9 blind hole or H7 reamed pass-through hole
- Type 2 - Crank handle with fold-away handle. Black-oxide steel hub, H9 blind hole or H7 reamed pass-through hole
- Type 3 - Crank handle with revolving handle. Not removable. Black-oxide steel hub, H9 blind hole
- Type 4 - Crank handle with fold-away handle. Not removable. Black-oxide steel hub, H9 blind hole

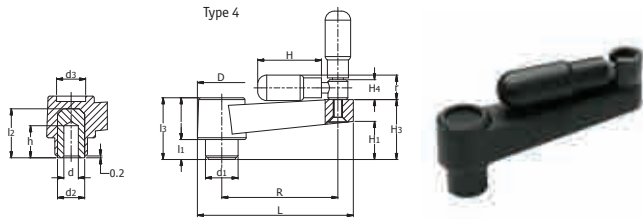
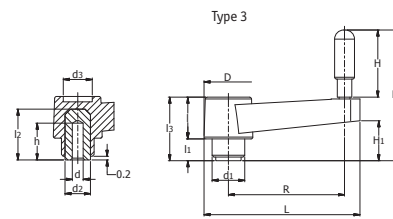
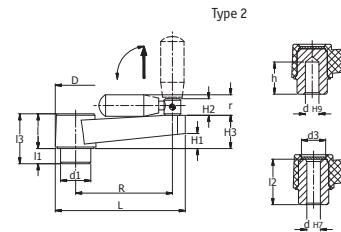
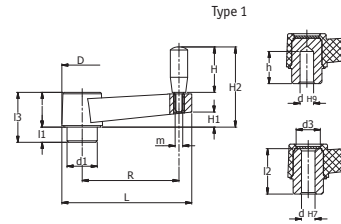

Part Number	Type	Dimensions (mm)										Mounting Hole (mm)				Handle		Weight (Grams)	Standard Pack Quantity
		R	L	D	d1	d3	l	l1	l3	H1	H2	dH7	dH9	l2	h	H	m		
1219315	1	50	69	23	16	13	21	10	31	10	49	6	-	28	-	28	-	65	1
1219316	1	64	86	27	18	16	23	10	33	10	63	-	6	29	18	40	M6	100	1
1219317	1	64	86	27	18	16	23	10	33	10	63	8	-	29	-	40	M6	95	1
1219319	1	80	105	30	22	17	26	10	36	13	76	-	6	32	26	50	M6	145	1
1219322	1	80	105	30	22	17	26	10	36	13	76	10	-	32	-	50	M6	130	1
1219297	1	100	128	34	24	21	30	10	40	15	96	-	8	37	28	65	M8	240	1
1219300	1	100	128	34	24	21	30	10	40	15	96	12	-	37	-	65	M8	225	1
1219302	1	130	162	40	28	25	35	14	49	20	115	-	10	44	30	80	M8	345	1
1219305	1	130	162	40	28	25	35	14	49	20	115	14	-	44	-	80	M8	310	1
1219308	1	160	198	45	34	27	40	15	55	23	130	-	10	49	30	90	M10	495	1
1219311	1	160	198	45	34	27	40	15	55	23	130	16	-	49	-	90	M10	435	1
1219313	1	212	252	50	40	31	45	15	60	26	136	-	12	53	30	90	M10	705	1

Part Number	Type	Dimensions (mm)										Mounting Hole (mm)				Handle		Weight (Grams)	Standard Pack Quantity	
		R	L	D	d1	d3	l	l1	l3	H1	H3	r	dH7	dH9	l2	h	H			H2
1219320	2	80	105	30	22	17	26	10	36	13	27	19	-	6	32	26	56	15	177	1
1219321	2	80	105	30	22	17	26	10	36	13	27	19	10	-	32	-	56	15	163	1
1219298	2	100	128	34	24	21	30	10	40	15	31	22	-	8	37	28	65	20	285	1
1219299	2	100	128	34	24	21	30	10	40	15	31	22	12	-	37	-	65	20	265	1
1219303	2	130	162	40	28	25	35	14	49	20	35	22	-	10	44	30	65	20	385	1
1219304	2	130	162	40	28	25	35	14	49	20	35	22	14	-	44	-	65	20	340	1
1219309	2	160	198	45	34	27	40	15	55	23	40	24	-	10	49	30	80	20	525	1
1219310	2	160	198	45	34	27	40	15	55	23	40	24	16	-	49	-	80	20	473	1
1219314	2	212	252	50	40	31	45	15	60	26	46	27	-	12	53	30	90	23	840	1

Part Number	Type	Dimensions (mm)										Mounting Hole (mm)		Handle		Weight (Grams)	Standard Pack Quantity	
		R	L	D	d1	d3	l	l1	l3	d2	l2	H1	H2	dH9	h			H
1219323	3	80	106	30	24	17	26	11	37	18	31	23.5	99	10	25	60	118	1
1219301	3	100	128	33.5	24	21	30.5	10	40.5	18	31	25	106	12	24	65	190	1
1219306	3	130	162	39	34	25	35	14	49	26	43	32.5	113	14	30	65	335	1
1219312	3	160	197	44	34.5	27	39.5	15	54.5	26	43	36	136	16	30	80	375	1

Part Number	Type	Dimensions (mm)										Mounting Hole (mm)		Handle			Weight (Grams)	Standard Pack Quantity		
		R	L	D	d1	d3	l	l1	l3	d2	l2	H1	H3	dH9	h	H			H4	r
1219318	4	64	86	26.5	20	16	22.5	9	31.5	15	25	17.5	31	8	20	45	14	16	89	1
1219307	4	130	162	39	34	25	35	14	49	26	43	34	49	14	30	65	18.5	20.5	330	1

CLAMPING HANDLES

Cranked Handle

SR 6557

Black powder coated Aluminium

- The handle is revolving
- Type 1: Tolerance class H7 for Bore
- Type 2: Tolerance class H11 for Square Hole

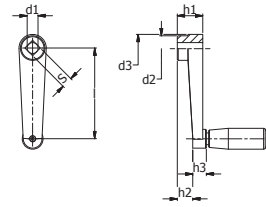

Part Number	Type	Dimensions (mm)									Standard Pack Quantity
		d1 H7 Bore	sH 11 Square	Length L	d2	d3	h1	h2~	h3	Ø Handle	
1220666	1	B10	-	80	23	26	24	14	14	21	1
1220667	2	-	V10	80	23	26	24	14	14	21	1
1220668	1	B12	-	100	27	30	28	17	15	23	1
1220669	2	-	V12	100	27	30	28	17	15	23	1
1220670	1	B14	-	125	32	35	34	22	18	26	1
1220671	2	-	V14	125	32	35	34	22	18	26	1
1220672	1	B17	-	160	35	39	38	26	18	26	1
1220673	2	-	V17	160	35	39	38	26	18	26	1

Clamp Nuts

SR 6558

- The shaft is butt-welded to the nut
- Type 1: Zinc Plated blue passivated steel
- Type 2: Matte shot-blasted stainless steel AISI 304

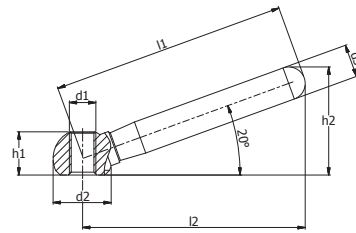

Part Number	Type	Dimensions (mm)								Standard Pack Quantity
		l1	d1	d2	d3	h1	h2 ≈	l2 ≈		
1220674	1	63	M8	16	10	12.5	30.5	60	5	
1220675	1	80	M10	20	12	15	37	76	5	
1220676	1	100	M12	25	14	19	46	95	5	
1220677	1	125	M16	32	18	25	58.5	119	5	
1220678	1	160	M20	40	20	31	73	152	5	
1220679	2	63	M8	16	10	12.5	30.5	60	5	
1220680	2	80	M10	20	12	15	37	76	5	
1220681	2	100	M12	25	14	19	46	95	5	
1220682	2	125	M16	32	18	25	58.5	119	5	
1220683	2	160	M20	40	20	31	73	152	5	

Clamp Nuts with Double Lever

SR 6559

- Two levers allow the clamping operation to be realized with both hands to achieve a higher clamping force
- The shaft is butt-welded to the nut
- Type 1: Zinc Plated blue passivated steel
- Type 2: Matte shot-blasted stainless steel AISI 304

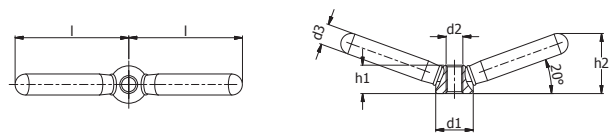
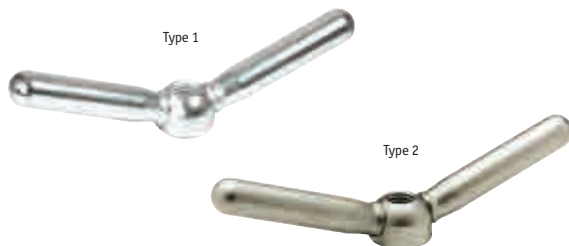

Part Number	Type	Dimensions (mm)						Standard Pack Quantity
		d1	d2	d3	h1	h2 ≈	Length l ≈	
1220684	1	16	M8	10	12.5	26	47.5	5
1220685	1	20	M10	12	15	32	59.5	5
1220686	1	25	M12	14	19	40	75.5	5
1220687	1	32	M16	18	25	52	94.5	5
1220688	1	40	M20	20	31	62	118	5
1220689	2	16	M8	10	12.5	26	47.5	5
1220690	2	20	M10	12	15	32	59.5	5
1220691	2	25	M12	14	19	40	75.5	5
1220692	2	32	M16	18	25	52	94.5	5
1220693	2	40	M20	20	31	62	118	5

Indexed Clamping Handles

SR 1536

Glass Filled PA 6

- Operate by simple lift and rotate action
- Include ratchet for use in tight spaces
- Easy handle adjustment to safe position

Female –Black

Part Number	Dimensions (mm)				Thread	Standard Pack Quantity
	L	h	d	H		
466295	43	26	12	32	M5	10
466296	43	26	12	32	M6	10
466297	65	37	15	46	M6	10
466298	65	37	15	46	M8	10
466299	83	46	19	57	M10	10
466300	104	51	24	68	M12	10

Male –Black

Part Number	Dimensions (mm)				Thread	Thread Length (mm)	Standard Pack Quantity
	L	h	d	H			
466672	43	26	12	32	M5	10	10
466673	43	26	12	32	M5	15	10
466301	43	26	12	32	M5	20	10
466674	43	26	12	32	M5	25	10
466675	43	26	12	32	M6	10	10
466676	43	26	12 <td 32	M6	15	10	
466302	43	26	12	32	M6	20	10
466677	43	26	12	32	M6	25	10
466420	65	37	15	46	M8	10	10
466421	65	37	15	46	M8	16	10
466303	65	37	15	46	M8	30	10
466304	65	37	15	46	M8	40	10
466422	65	37	15	46	M8	45	10
466680	83	46	19	57	M10	20	10
466305	83	46	19	57	M10	30	10
466306	83	46	19	57	M10	40	10
466682	83	46	19	57	M10	50	10
466423	104	51	24	68	M12	20	10
466307	104	51	24	68	M12	35	10
466424	104	51	24	68	M12	50	10

Female –High Visibility Orange

Part Number	Dimensions (mm)				Thread	Standard Pack Quantity
	L	h	d	H		
465999	43	26	12	32	M5	10
466000	43	26	12	32	M6	10
466001	65	37	15	46	M6	10
466002	65	37	15	46	M8	10
466003	83	46	19	57	M10	10
466004	104	51	24	68	M12	10

Male –Black

Part Number	Dimensions (mm)				Thread	Thread Length (mm)	Standard Pack Quantity
	L	h	d	H			
466005	43	26	12	32	M5	20	10
466006	43	26	12	32	M6	20	10
466007	65	37	15	46	M8	30	10
466008	65	37	15	46	M8	40	10
466009	83	46	19	57	M10	30	10
466010	83	46	19	57	M10	40	10
466011	104	51	24	68	M12	35	10

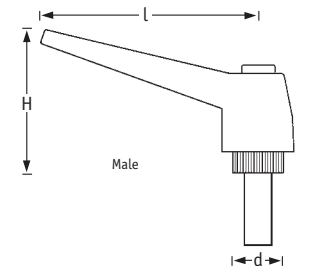
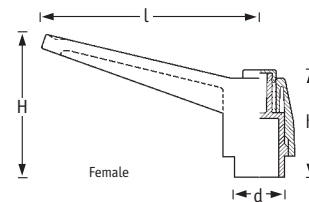

CLAMPING HANDLES

Heavy Duty Clamping Handles

SR 1536

Die-Cast Zinc

- Handle made from pressure die-cast zinc
- Plastic coated handle
- Operate by simple lift and rotate action
- Available with zinc plated or 304 stainless steel thread

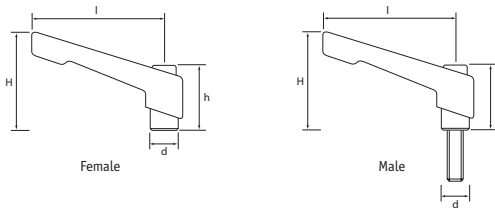

Female

Part Number	Stainless Steel Thread	Dimensions (mm)				Thread Size	Standard Pack Quantity
		L	h	d	H		
490918	-	42	25.0	9.7	37	M5	10
490919	493877	42	25.0	9.7	37	M6	10
490920	493878	65	31.5	13.5	50	M6	10
490921	493879	65	31.5	13.5	50	M8	10
490922	493880	78	36.0	15.7	58	M8	10
490923	493881	78	36.0	15.7	58	M10	10
490924	493882	92	43.0	18.5	69	M10	10
490925	493883	92	43.0	18.5	69	M12	10
490926	-	108	51.0	22.7	79	M12	10
490927	-	108	51.0	22.7	79	M16	10

Male

Part Number	Stainless Steel Thread	Dimensions (mm)				Thread Size	Thread Length (mm)	Standard Pack Quantity
		L	h	d	H			
490928	493884	42	25.0	9.7	37	M6	20	10
490929	493885	42	25.0	9.7	37	M6	32	10
490930	-	42	25.0	9.7	37	M6	40	10
490931	-	65	31.5	13.5	50	M8	16	10
490932	493886	65	31.5	13.5	50	M8	20	10
490933	493887	65	31.5	13.5	50	M8	25	10
490934	493888	65	31.5	13.5	50	M8	32	10
490935	-	65	31.5	13.5	50	M8	40	10
490936	493890	65	31.5	13.5	50	M8	50	10
490937	493891	78	36.0	15.7	58	M10	20	10
490938	493892	78	36.0	15.7	58	M10	32	10
490939	493893	78	36.0	15.7	58	M10	40	10
490940	-	78	36.0	15.7	58	M10	50	10
490941	-	78	36.0	15.7	58	M10	63	10
490942	-	92	43.0	18.5	69	M12	25	10
490943	493894	92	43.0	18.5	69	M12	32	10
490944	493895	92	43.0	18.5	69	M12	40	10
-	493896	92	43.0	18.5	69	M12	50	10
490945	-	92	43.0	18.5	69	M12	63	10
-	493897	108	51.0	22.7	79	M12	63	10
490946	-	108	51.0	22.7	79	M16	40	10

Heavy Duty Clamping Handles – Stainless Steel

SR 5486

Stainless Steel

- Entire component made from stainless steel
- Operate by simple lift and rotate action
- Ideal for the medical, pharmaceutical and food preparation industries
- For heavy duty applications

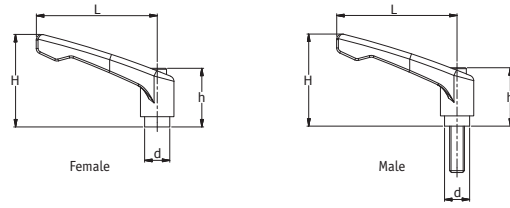

Female

Part Number	Dimensions (mm)				Thread Size	Standard Pack Quantity
	L	h	d	H		
498489	42	25.0	9.7	37	M5	10
498490	42	25.0	9.7	37	M6	10
498491	65	31.5	13.5	50	M6	10
498492	65	31.5	13.5	50	M8	10
498493	78	36.0	15.7	58	M8	10
498494	78	36.0	15.7	58	M10	10
498495	92	43.0	18.5	69	M10	10
498496	92	43.0	18.5	69	M12	10
498497	108	51.0	22.7	79	M12	10
498498	108	51.0	22.7	79	M16	10

Male

Part Number	Thread Size	Dimensions (mm)				Standard Pack Quantity	
		Thread Length	L	h	d		H
498499	M6	42	25.0	9.7	37	20	10
498500	M6	42	25.0	9.7	37	32	10
498501	M6	42	25.0	9.7	37	40	10
498502	M8	65	31.5	13.5	50	16	10
498504	M8	65	31.5	13.5	50	25	10
498505	M8	65	31.5	13.5	50	32	10
498506	M8	65	31.5	13.5	50	40	10
498507	M8	65	31.5	13.5	50	50	10
498508	M10	78	36.0	15.7	58	20	10
498509	M10	78	36.0	15.7	58	32	10
498510	M10	78	36.0	15.7	58	40	10
498511	M10	78	36.0	15.7	58	50	10
498514	M12	92	43.0	18.5	69	32	10
498515	M12	92	43.0	18.5	69	40	10
498519	M16	108	51.0	22.7	79	40	10

Adjustable Handles with Threaded Hole or Threaded Stud

SR 6561

- Material - Lever body is made from Glass-fibre reinforced polyamide based (PA) technopolymer. The push button is made from Technopolymer in Ergostyle colours, glossy finish
- Handle Colour - Grey-black, matte finish
- Both Types have a glass-fibre reinforced technopolymer clamping element with retaining pin, black colour, with knurling on the protruding part to make initial tightening easier. AISI 302 stainless steel return spring
- Type 1 - Adjustable Handle with brass boss, threaded blind hole
- Type 2 - Adjustable Handle with zinc-plated steel threaded stud, chamfered flat end UNI 947: ISO 4753

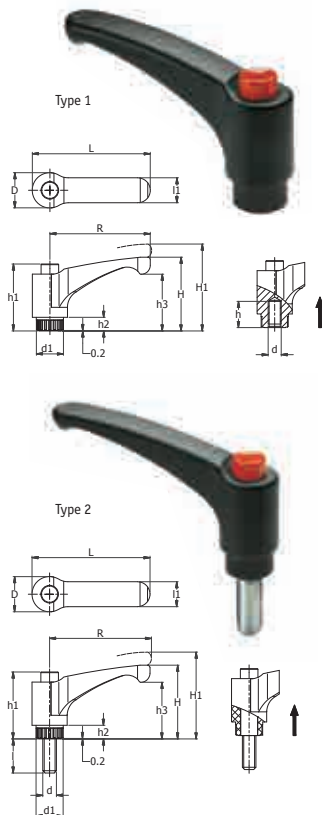

Part Number	Type	Colour of Push Button	Dimensions (mm)										Mounting Hole		Teeth No.	Weight (Grams)	Standard Pack Quantity
			R	L	D	H	H1	h1	h2	h3	d1	l1	d6H	h			
1219229	1	Black	30	37.5	15.5	30	33.5	29.5	6	23	12	9	M3	10	18	8	10
1219230	1	Orange	30	37.5	15.5	30	33.5	29.5	6	23	12	9	M3	10	18	8	10
1219231	1	Grey	30	37.5	15.5	30	33.5	29.5	6	23	12	9	M3	10	18	8	10
1219232	1	Red	30	37.5	15.5	30	33.5	29.5	6	23	12	9	M3	10	18	8	10
1219233	1	Black	30	37.5	15.5	30	33.5	29.5	6	23	12	9	M4	10	18	8	10
1219234	1	Orange	30	37.5	15.5	30	33.5	29.5	6	23	12	9	M4	10	18	8	10
1219235	1	Grey	30	37.5	15.5	30	33.5	29.5	6	23	12	9	M4	10	18	8	10
1219236	1	Red	30	37.5	15.5	30	33.5	29.5	6	23	12	9	M4	10	18	8	10
1219249	1	Black	44	52	15.5	32.5	36	29.5	6	25	12	11	M5	10	18	10	10
1219250	1	Orange	44	52	15.5	32.5	36	29.5	6	25	12	11	M5	10	18	10	10
1219251	1	Grey	44	52	15.5	32.5	36	29.5	6	25	12	11	M5	10	18	10	10
1219252	1	Red	44	52	15.5	32.5	36	29.5	6	25	12	11	M5	10	18	10	10
1219253	1	Black	44	52	15.5	32.5	36	29.5	6	25	12	11	M6	10	18	10	10
1219254	1	Orange	44	52	15.5	32.5	36	29.5	6	25	12	11	M6	10	18	10	10
1219255	1	Grey	44	52	15.5	32.5	36	29.5	6	25	12	11	M6	10	18	10	10
1219256	1	Red	44	52	15.5	32.5	36	29.5	6	25	12	11	M6	10	18	10	10
1219273	1	Black	63	73.5	19	43	47	37.5	8	34.5	15	13.5	M8	13	20	20	10
1219274	1	Orange	63	73.5	19	43	47	37.5	8	34.5	15	13.5	M8	13	20	20	10
1219275	1	Grey	63	73.5	19	43	47	37.5	8	34.5	15	13.5	M8	13	20	20	10
1219276	1	Red	63	73.5	19	43	47	37.5	8	34.5	15	13.5	M8	13	20	20	10

Part Number	Type	Colour of Push Button	Dimensions (mm)										Threaded Stud		Teeth No.	Weight (Grams)	Standard Pack Quantity
			R	L	D	H	H1	h1	h2	h3	d1	l1	d6g	l			
1219237	2	Black	30	37.5	15.5	30	33.5	29.5	6	23	12	9	M5	10	18	6	10
1219238	2	Orange	30	37.5	15.5	30	33.5	29.5	6	23	12	9	M5	10	18	6	10
1219239	2	Grey	30	37.5	15.5	30	33.5	29.5	6	23	12	9	M5	10	18	6	10
1219240	2	Red	30	37.5	15.5	30	33.5	29.5	6	23	12	9	M5	10	18	6	10
1219241	2	Black	30	37.5	15.5	30	33.5	29.5	6	23	12	9	M5	16	18	6	10
1219242	2	Orange	30	37.5	15.5	30	33.5	29.5	6	23	12	9	M5	16	18	6	10
1219243	2	Grey	30	37.5	15.5	30	33.5	29.5	6	23	12	9	M5	16	18	6	10
1219244	2	Red	30	37.5	15.5	30	33.5	29.5	6	23	12	9	M5	16	18	6	10
1219245	2	Black	30	37.5	15.5	30	33.5	29.5	6	23	12	9	M5	20	18	7	10
1219246	2	Orange	30	37.5	15.5	30	33.5	29.5	6	23	12	9	M5	20	18	7	10
1219247	2	Grey	30	37.5	15.5	30	33.5	29.5	6	23	12	9	M5	20	18	7	10
1219248	2	Red	30	37.5	15.5	30	33.5	29.5	6	23	12	9	M5	20	18	7	10
1219257	2	Black	44	52	15.5	32.5	36	29.5	6	25	12	11	M6	10	18	13	10
1219258	2	Orange	44	52	15.5	32.5	36	29.5	6	25	12	11	M6	10	18	13	10
1219259	2	Grey	44	52	15.5	32.5	36	29.5	6	25	12	11	M6	10	18	13	10
1219260	2	Red	44	52	15.5	32.5	36	29.5	6	25	12	11	M6	10	18	13	10
1219261	2	Black	44	52	15.5	32.5	36	29.5	6	25	12	11	M6	16	18	14	10
1219262	2	Orange	44	52	15.5	32.5	36	29.5	6	25	12	11	M6	16	18	14	10
1219263	2	Grey	44	52	15.5	32.5	36	29.5	6	25	12	11	M6	16	18	14	10
1219264	2	Red	44	52	15.5	32.5	36	29.5	6	25	12	11	M6	16	18	14	10
1219265	2	Black	44	52	15.5	32.5	36	29.5	6	25	12	11	M6	20	18	15	10
1219266	2	Orange	44	52	15.5	32.5	36	29.5	6	25	12	11	M6	20	18	15	10
1219267	2	Grey	44	52	15.5	32.5	36	29.5	6	25	12	11	M6	20	18	15	10
1219268	2	Red	44	52	15.5	32.5	36	29.5	6	25	12	11	M6	20	18	15	10
1219269	2	Black	44	52	15.5	32.5	36	29.5	6	25	12	11	M6	30	18	17	10
1219270	2	Orange	44	52	15.5	32.5	36	29.5	6	25	12	11	M6	30	18	17	10
1219271	2	Grey	44	52	15.5	32.5	36	29.5	6	25	12	11	M6	30	18	17	10
1219272	2	Red	44	52	15.5	32.5	36	29.5	6	25	12	11	M6	30	18	17	10
1219277	2	Black	63	73.5	19	43	47	37.5	8	34.5	15	13.5	M8	16	20	32	10
1219278	2	Orange	63	73.5	19	43	47	37.5	8	34.5	15	13.5	M8	16	20	32	10
1219279	2	Grey	63	73.5	19	43	47	37.5	8	34.5	15	13.5	M8	16	20	32	10
1219280	2	Red	63	73.5	19	43	47	37.5	8	34.5	15	13.5	M8	16	20	32	10
1219281	2	Black	63	73.5	19	43	47	37.5	8	34.5	15	13.5	M8	20	20	32	10
1219282	2	Orange	63	73.5	19	43	47	37.5	8	34.5	15	13.5	M8	20	20	32	10
1219283	2	Grey	63	73.5	19	43	47	37.5	8	34.5	15	13.5	M8	20	20	32	10
1219284	2	Red	63	73.5	19	43	47	37.5	8	34.5	15	13.5	M8	20	20	32	10
1219285	2	Black	63	73.5	19	43	47	37.5	8	34.5	15	13.5	M8	25	20	34	10
1219286	2	Orange	63	73.5	19	43	47	37.5	8	34.5	15	13.5	M8	25	20	34	10
1219287	2	Grey	63	73.5	19	43	47	37.5	8	34.5	15	13.5	M8	25	20	34	10
1219288	2	Red	63	73.5	19	43	47	37.5	8	34.5	15	13.5	M8	25	20	34	10
1219289	2	Black	63	73.5	19	43	47	37.5	8	34.5	15	13.5	M8	30	20	36	10
1219290	2	Orange	63	73.5	19	43	47	37.5	8	34.5	15	13.5	M8	30	20	36	10
1219291	2	Grey	63	73.5	19	43	47	37.5	8	34.5	15	13.5	M8	30	20	36	10
1219292	2	Red	63	73.5	19	43	47	37.5	8	34.5	15	13.5	M8	30	20	36	10
1219293	2	Black	63	73.5	19	43	47	37.5	8	34.5	15	13.5	M8	40	20	40	10
1219294	2	Orange	63	73.5	19	43	47	37.5	8	34.5	15	13.5	M8	40	20	40	10
1219295	2	Grey	63	73.5	19	43	47	37.5	8	34.5	15	13.5	M8	40	20	40	10
1219296	2	Red	63	73.5	19	43	47	37.5	8	34.5	15	13.5	M8	40	20	40	10

CLAMPING HANDLES

Cam Clamp Levers with and without Adjustable Ring-Nut

SR 6562



Type 1 - 3



Type 4 - 6

- Cam lever body - Glass-fibre reinforced polyamide based (PA) technopolymer, black colour, matte finish
- Type 1: Positioning without adjustable ring-nut, rotating pin with zinc-plated steel threaded hole
- Type 2: Positioning without adjustable ring-nut, rotating pin with AISI 303 stainless steel threaded hole
- Type 3: Positioning without adjustable ring-nut, rotating pin with zinc-plated steel threaded stud, chamfered flat end UNI 947: ISO 4753
- Type 4: Positioning with adjustable ring-nut, rotating pin with zinc-plated steel threaded hole
- Type 5: Positioning with adjustable ring-nut, rotating pin with AISI 303 stainless steel threaded hole
- Type 6: Positioning with adjustable ring-nut, rotating pin with threaded stud in zinc-plated steel, chamfered flat end UNI 947: ISO 4753

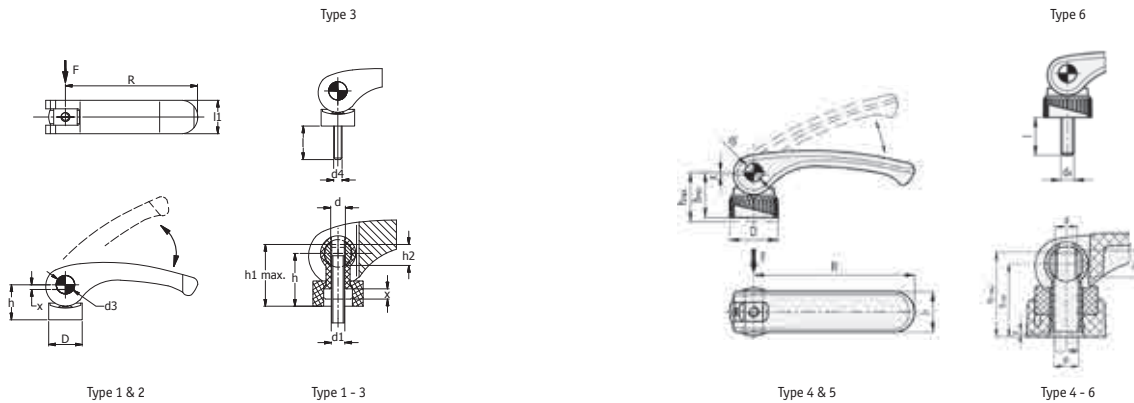

Type 1 & 2

Type 1 - 3

Type 4 & 5

Type 4 - 6

Part Number	Type	Dimensions (mm)													Pull Force		Weight (Grams)	Standard Pack Quantity
		R	l1	D	d	h	x	h1max	h2	d1	d3	d4	l	Fmax [N]				
1219324	1	63	18	18	M6	18	0.75	20	4	6.1	9	-	-	4000	23	1		
1219328	1	79	20	20	M8	21	1	25.5	7	8.1	11	-	-	7000	32	1		
1219327	2	63	18	18	M6	18	0.75	20	4	6.1	9	-	-	4000	23	1		
1219331	2	79	20	20	M8	21	1	25.5	7	8.1	11	-	-	7000	32	1		
1219325	3	63	18	18	M6	18	0.75	-	-	6.1	9	M6	25	4000	33	1		
1219326	3	63	18	18	M6	18	0.75	-	-	6.1	9	M6	50	4000	42	1		
1219329	3	79	20	20	M8	21	1	-	-	8.1	11	M8	25	7000	46	1		
1219330	3	79	20	20	M8	21	1	-	-	8.1	11	M8	50	7000	55	1		

Part Number	Type	Dimensions (mm)													Pull Force		Weight (Grams)	Standard Pack Quantity
		R	l1	D	d	hmin	hmax	x	h1max	h2	d1	d3	d4	l	Fmax [N]			
1219332	4	63	18	21	M6	22.5	24	0.75	26	4	6.1	9	-	-	4000	25	1	
1219338	4	79	20	25	M8	26.5	28	1	32.5	7	8.1	11	-	-	7000	39	1	
1219335	5	63	18	21	M6	22.5	24	0.75	26	4	6.1	9	-	-	4000	25	1	
1219339	5	79	20	25	M8	26.5	28	1	32.5	7	8.1	11	-	-	7000	39	1	
1219333	6	63	18	21	M6	22.5	24	0.75	-	-	6.1	9	M6	25	4000	35	1	
1219334	6	63	18	21	M6	22.5	24	0.75	-	-	6.1	9	M6	50	4000	44	1	
1219336	6	79	20	25	M8	26.5	28	1	-	-	8.1	11	M8	25	7000	53	1	
1219337	6	79	20	25	M8	26.5	28	1	-	-	8.1	11	M8	50	7000	62	1	

Open Handled Clamp Lever

SR 1536

Black Glass Filled PA

- Open handle design to stop dust collection
- Low profile handle for use in limited space applications

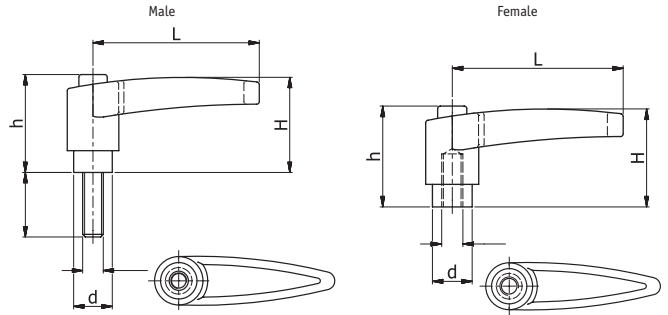

Male

Part Number	Dimensions (mm)				Thread Size	Thread Length (mm)	Standard Pack Quantity
	L	h	d	H			
496352	43	29	12	28	M4	10	10
496353	43	29	12	28	M5	20	10
496355	43	29	12	28	M6	10	10
496356	43	29	12	28	M6	20	10
496357	43	29	12	28	M6	30	10
496360	64.5	38	15	37	M8	15	10
496361	64.5	38	15	37	M8	20	10
496362	64.5	38	15	37	M8	25	10
496363	64.5	38	15	37	M8	30	10
496364	64.5	38	15	37	M8	40	10
496367	79.5	47	18.5	45	M10	20	10
496368	79.5	47	18.5	45	M10	30	10
496369	79.5	47	18.5	45	M10	40	10
496370	79.5	47	18.5	45	M10	50	10
496372	79.5	47	18.5	45	M12	30	10
496373	79.5	47	18.5	45	M12	50	10

Female

Part Number	Dimensions (mm)				Thread Size	Standard Pack Quantity
	L	h	d	H		
496354	43	29	12	28	M5	10
496358	43	29	12	28	M6	10
496359	64.5	38	15	37	M6	10
496365	64.5	38	15	37	M8	10
496366	79.5	47	18.5	45	M8	10
496371	79.5	47	18.5	45	M10	10

Reinforced Clamping Handles

SR 1536

Black 6 Glass Filled

- Zinc Teeth Insert
- Indexing Parts & Thread from Steel

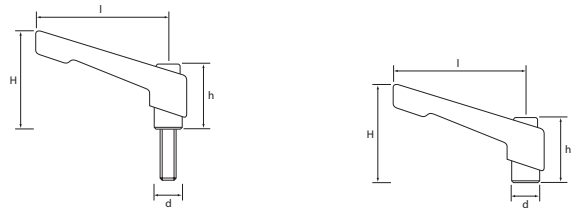

Male

Part Number	Dimensions (mm)				Thread Size	Thread Length (mm)	Standard Pack Quantity
	L	h	d	H			
490954	42	25.0	9.7	37	M4	12	10
490955	42	25.0	9.7	37	M5	20	10
490956	42	25.0	9.7	37	M6	16	10
490957	42	25.0	9.7	37	M6	20	10
490958	42	25.0	9.7	37	M6	32	10
490959	65	31.5	13.5	50	M8	16	10
490960	65	31.5	13.5	50	M8	20	10
490961	65	31.5	13.5	50	M8	25	10
490962	65	31.5	13.5	50	M8	32	10
490963	65	31.5	13.5	50	M8	40	10
490964	84	36.0	15.7	61	M10	20	10
490965	84	36.0	15.7	61	M10	32	10
490966	84	36.0	15.7	61	M10	40	10
490967	84	36.0	15.7	61	M10	50	10
490968	84	36.0	15.7	61	M12	50	10

Female

Part Number	Dimensions (mm)				Thread Size	Standard Pack Quantity
	L	h	d	H		
490947	42	25.0	9.7	37	M5	10
490948	42	25.0	9.7	37	M6	10
490949	65	31.5	13.5	50	M6	10
490950	65	31.5	13.5	50	M8	10
490951	84	36.0	15.7	61	M8	10
490952	84	36.0	15.7	61	M10	10
490953	84	36.0	15.7	61	M12	10

CLAMPING HANDLES

Clamping Levers with Eccentric Cam

SR 6563

Black powder coated Die Cast Zinc

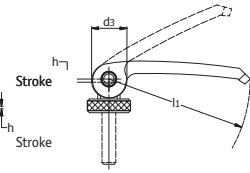
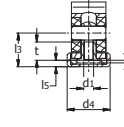
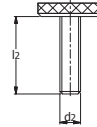
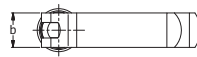

- Clamping Levers with Eccentric Cam with Stainless Steel threaded stud are used for rapid clamping and releasing
- The lever has been designed to ensure that its movement cannot exceed the maximum clamping force
- The distance between the lever cam and the clamping surface is adjustable via a fine pitch thread, allowing the clamping position to be set easily with maximum clamping force

Part Number	Dimensions (mm)											Standard Pack Quantity
	l1	d2	l2 in clamping position	b	d3	d4	h stroke at 90° lever movement	l3 in clamping position min.	max.	l5 in clamping position	t useable thread length	
1220710	63	M5	16	16	16	19	0.75	16.3	18.8	16.3	10	2
1220711	63	M5	20	16	16	19	0.75	16.3	18.8	16.3	10	2
1220712	63	M5	25	16	16	19	0.75	16.3	18.8	16.3	10	2
1220713	63	M5	30	16	16	19	0.75	16.3	18.8	16.3	10	2
1220714	63	M5	35	16	16	19	0.75	16.3	18.8	16.3	10	2
1220715	63	M5	40	16	16	19	0.75	16.3	18.8	16.3	10	2
1220716	63	M5	50	16	16	19	0.75	16.3	18.8	16.3	10	2
1220717	63	M5 - female	-	16	16	19	0.75	16.3	18.8	16.3	10	2
1220718	63	M6	16	16	16	19	0.75	16.3	18.8	16.3	10	2
1220719	63	M6	20	16	16	19	0.75	16.3	18.8	16.3	10	2
1220720	63	M6	25	16	16	19	0.75	16.3	18.8	16.3	10	2
1220721	63	M6	30	16	16	19	0.75	16.3	18.8	16.3	10	2
1220722	63	M6	35	16	16	19	0.75	16.3	18.8	16.3	10	2
1220723	63	M6	40	16	16	19	0.75	16.3	18.8	16.3	10	2
1220724	63	M6	50	16	16	19	0.75	16.3	18.8	16.3	10	2
1220725	63	M6 - female	-	16	16	19	0.75	16.3	18.8	16.3	10	2
1220726	82	M6	20	20	20	25	1	19.5	22.5	19.5	12	2
1220727	82	M6	25	20	20	25	1	19.5	22.5	19.5	12	2
1220728	82	M6	30	20	20	25	1	19.5	22.5	19.5	12	2
1220729	82	M6	35	20	20	25	1	19.5	22.5	19.5	12	2
1220730	82	M6	40	20	20	25	1	19.5	22.5	19.5	12	2
1220731	82	M6	50	20	20	25	1	19.5	22.5	19.5	12	2
1220732	82	M6	60	20	20	25	1	19.5	22.5	19.5	12	2
1220733	82	M6 - female	-	20	20	25	1	19.5	22.5	19.5	12	2
1220734	82	M8	20	20	20	25	1	19.5	22.5	19.5	12	2
1220735	82	M8	25	20	20	25	1	19.5	22.5	19.5	12	2
1220736	82	M8	30	20	20	25	1	19.5	22.5	19.5	12	2
1220737	82	M8	35	20	20	25	1	19.5	22.5	19.5	12	2
1220738	82	M8	40	20	20	25	1	19.5	22.5	19.5	12	2
1220739	82	M8	50	20	20	25	1	19.5	22.5	19.5	12	2
1220740	82	M8	60	20	20	25	1	19.5	22.5	19.5	12	2
1220741	82	M8 - female	-	20	20	25	1	19.5	22.5	19.5	12	2
1220702	101	M8	20	25	26	30	1.5	25.3	29.3	25.3	15	2
1220703	101	M8	25	25	26	30	1.5	25.3	29.3	25.3	15	2
1220704	101	M8	30	25	26	30	1.5	25.3	29.3	25.3	15	2
1220705	101	M8	35	25	26	30	1.5	25.3	29.3	25.3	15	2
1220706	101	M8	40	25	26	30	1.5	25.3	29.3	25.3	15	2
1220707	101	M8	50	25	26	30	1.5	25.3	29.3	25.3	15	2
1220708	101	M8	60	25	26	30	1.5	25.3	29.3	25.3	15	2
1220709	101	M8 - female	-	25	26	30	1.5	25.3	29.3	25.3	15	2
1220694	101	M10	20	25	26	30	1.5	25.3	29.3	25.3	15	2
1220695	101	M10	25	25	26	30	1.5	25.3	29.3	25.3	15	2
1220696	101	M10	30	25	26	30	1.5	25.3	29.3	25.3	15	2
1220697	101	M10	35	25	26	30	1.5	25.3	29.3	25.3	15	2
1220698	101	M10	40	25	26	30	1.5	25.3	29.3	25.3	15	2
1220699	101	M10	50	25	26	30	1.5	25.3	29.3	25.3	15	2
1220700	101	M10	60	25	26	30	1.5	25.3	29.3	25.3	15	2
1220701	101	M10 - female	-	25	26	30	1.5	25.3	29.3	25.3	15	2

Aluminium Cam Levers

SR 5493

Aluminium

Part Number	Type	Dimensions (mm)					Std Pack Qty
		Thread Size	L	H	h1	D	
KCL-14	Female	M5 x 0.80	70.4	22.0	-	18.0	10
KCL-16	Female	M6 x 1.00	70.4	22.0	-	18.0	10
KCL-18	Female	M8 x 1.25	96.0	28.5	-	27.0	10
KCL-90	Male	M5 x 0.80	70.4	22.0	20.0	18.0	10
KCL-94	Male	M5 x 0.80	70.4	22.0	40.0	18.0	10
KCL-98	Male	M6 x 1.00	70.4	22.0	20.0	18.0	10
KCL-100	Male	M6 x 1.00	70.4	22.0	30.0	18.0	10
KCL-102	Male	M6 x 1.00	70.4	22.0	40.0	18.0	10
KCL-104	Male	M6 x 1.00	70.4	22.0	50.0	18.0	10
KCL-106	Male	M8 x 1.25	96.0	28.5	25.0	27.0	10
KCL-108	Male	M8 x 1.25	96.0	28.5	30.0	27.0	10
KCL-110	Male	M8 x 1.25	96.0	28.5	40.0	27.0	10
KCL-112	Male	M8 x 1.25	96.0	28.5	50.0	27.0	10
KCL-114	Male	M10 x 1.50	96.0	28.5	25.0	27.0	10
KCL-116	Male	M10 x 1.50	96.0	28.5	30.0	27.0	10
KCL-118	Male	M10 x 1.50	96.0	28.5	40.0	27.0	10
KCL-120	Male	M10 x 1.50	96.0	28.5	50.0	27.0	10

- Cast aluminium cam handle with a fibreglass reinforced plastic washer
- Cam Lever handles allow for quick fastening and unfastening without the use of tools
- Threaded internally

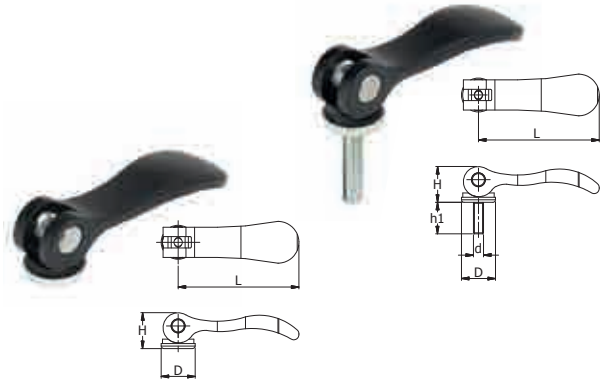

Index Plunger – with or without 90° Locking Rest Position

SR 5405

Knob: High Impact Resistant Thermoplastic

Insert: Burnished or Stainless Steel



- Matte Finish
- Used for locating, positioning, indexing and securing
- Allow for rapid adjustments on a variety of platforms, fixtures and tables
- Suitable for gym equipment, medical aids, catering equipment, conveyors etc.



Part Number	Thread Size	Type	Locking Rest Position	Insert Material	Dimensions (mm)					Plunger Diameter	Standard Pack Quantity
					D	H	h1	h2	h3		
491224	M10 x 1.0	1	Yes	Burnished Steel	21	51.0	5	17	5	5.0	5
491225	M12 x 1.5	1	Yes	Burnished Steel	25	61.0	6	20	6	6.0	5
491226	M16 x 1.5	1	Yes	Burnished Steel	31	77.0	8	26	7	8.0	5
491227	M10 x 1.0	2	Yes	Stainless Steel	21	51.0	5	17	5	5.0	2
491228	M12 x 1.5	2	Yes	Stainless Steel	25	61.0	6	20	6	6.0	2
491229	M16 x 1.5	2	Yes	Stainless Steel	31	77.0	8	26	7	8.0	2
491234	M10 x 1.0	3	No	Burnished Steel	21	45.0	5	17	5	5.0	5
491235	M10 x 1.0	3	No	Burnished Steel	21	51.0	5	17	5	5.0	5
491232	M12 x 1.5	3	No	Burnished Steel	25	45.0	5	10	6	6.0	5
491236	M12 x 1.5	3	No	Burnished Steel	25	61.0	6	20	6	6.0	5
491233	M16 x 1.5	3	No	Burnished Steel	31	55.0	6	12	8	8.0	5
491237	M16 x 1.5	3	No	Burnished Steel	31	77.0	8	26	7	8.0	5
491230	M12 x 1.5	4	Yes	Burnished Steel	25	45.0	5	10	6	6.0	5
491231	M16 x 1.5	4	Yes	Burnished Steel	31	55.0	6	12	8	8.0	5

INDEX PLUNGERS

Mini Indexing Plunger

SR 6564

- Type 1: Zinc plated steel socket. Stainless Steel AISI 303 plunger and AISI 301 spring
- Type 2: Stainless Steel AISI 303 socket and plunger, AISI 301 spring
- Style 1: Plastic Polyamide, black matt knob without rest position
- Style 2: Plastic Polyamide, black matt knob with rest position

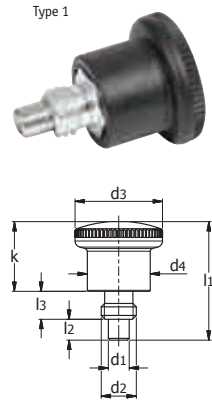

Part Number	Type	Style	Dimensions (mm)										Spring load in N ≈		Standard Pack Quantity
			d1 Plunger h9 Bore+0,03/+0,08	d2 (metric standard thread)	d2 (metric fine thread)	d3	d4	l1	l2 min.	l3	k	initial	end		
1220742	1	1	4	M8	-	21	15	27.5	5	6	16.5	4	12	10	
1220743	1	2	4	M8	-	21	15	27.5	5	6	16.5	4	12	10	
1220744	1	1	4	-	M8 x 1	21	15	27.5	5	6	16.5	4	12	10	
1220745	1	2	4	-	M8 x 1	21	15	27.5	5	6	16.5	4	12	10	
1220746	1	1	5	M10	-	25	18	34	6	8	20	6	16	10	
1220747	1	2	5	M10	-	25	18	34	6	8	20	6	16	10	
1220748	1	1	5	-	M10 x 1	25	18	34	6	8	20	6	16	10	
1220749	1	2	5	-	M10 x 1	25	18	34	6	8	20	6	16	10	
1220750	1	1	6	M10	-	25	18	34	6	8	20	6	16	10	
1220751	1	2	6	M10	-	25	18	34	6	8	20	6	16	10	
1220752	1	1	6	-	M10 x 1	25	18	34	6	8	20	6	16	10	
1220753	1	2	6	-	M10 x 1	25	18	34	6	8	20	6	16	10	
1220754	1	1	6	M12	-	28	20	40.5	7	10	23.5	10	23	10	
1220755	1	2	6	M12	-	28	20	40.5	7	10	23.5	10	23	10	
1220756	1	1	6	-	M12 x 1,5	28	20	40.5	7	10	23.5	10	23	10	
1220757	1	2	6	-	M12 x 1,5	28	20	40.5	7	10	23.5	10	23	10	
1220758	1	1	7	M12	-	28	20	40.5	7	10	23.5	10	23	10	
1220759	1	2	7	M12	-	28	20	40.5	7	10	23.5	10	23	10	
1220760	1	1	7	-	M12 x 1,5	28	20	40.5	7	10	23.5	10	23	10	
1220761	1	2	7	-	M 12 x 1,5	28	20	40.5	7	10	23.5	10	23	10	
1220762	1	1	8	M16	-	33	23	47.5	10	12	25.5	11	35	10	
1220763	1	2	8	M16	-	33	23	47.5	10	12	25.5	11	35	10	
1220764	1	1	8	-	M16 x 1,5	33	23	47.5	10	12	25.5	11	35	10	
1220765	1	2	8	-	M16 x 1,5	33	23	47.5	10	12	25.5	11	35	10	
1220766	1	1	10	M16	-	33	23	47.5	10	12	25.5	11	35	10	
1220767	1	2	10	M16	-	33	23	47.5	10	12	25.5	11	35	10	
1220768	1	1	10	-	M16 x 1,5	33	23	47.5	10	12	25.5	11	35	10	
1220769	1	2	10	-	M 16 x 1,5	33	23	47.5	10	12	25.5	11	35	10	



Part Number	Type	Style	Dimensions (mm)										Spring load in N ≈		Standard Pack Quantity
			d1 Plunger h9 Bore+0,03/+0,08	d2 (metric standard thread)	d2 (metric fine thread)	d3	d4	l1	l2 min.	l3	k	initial	end		
1220770	2	1	4	M8	-	21	15	27.5	5	6	16.5	4	12	10	
1220771	2	2	4	M8	-	21	15	27.5	5	6	16.5	4	12	10	
1220772	2	1	4	-	M8 x 1	21	15	27.5	5	6	16.5	4	12	10	
1220773	2	2	4	-	M8 x 1	21	15	27.5	5	6	16.5	4	12	10	
1220774	2	1	5	M10	-	25	18	34	6	8	20	6	16	10	
1220775	2	2	5	M10	-	25	18	34	6	8	20	6	16	10	
1220776	2	1	5	-	M10 x 1	25	18	34	6	8	20	6	16	10	
1220777	2	2	5	-	M10 x 1	25	18	34	6	8	20	6	16	10	
1220778	2	1	6	M10	-	25	18	34	6	8	20	6	16	10	
1220779	2	2	6	M10	-	25	18	34	6	8	20	6	16	10	
1220780	2	1	6	-	M10 x 1	25	18	34	6	8	20	6	16	10	
1220781	2	2	6	-	M10 x 1	25	18	34	6	8	20	6	16	10	
1220782	2	1	6	M12	-	28	20	40.5	7	10	23.5	10	23	10	
1220783	2	2	6	M12	-	28	20	40.5	7	10	23.5	10	23	10	
1220784	2	1	6	-	M12 x 1,5	28	20	40.5	7	10	23.5	10	23	10	
1220785	2	2	6	-	M12 x 1,5	28	20	40.5	7	10	23.5	10	23	10	
1220786	2	1	7	M12	-	28	20	40.5	7	10	23.5	10	23	10	
1220787	2	2	7	M12	-	28	20	40.5	7	10	23.5	10	23	10	
1220788	2	1	7	-	M12 x 1,5	28	20	40.5	7	10	23.5	10	23	10	
1220789	2	2	7	-	M12 x 1,5	28	20	40.5	7	10	23.5	10	23	10	
1220790	2	1	8	M16	-	33	23	47.5	10	12	25.5	11	35	10	
1220791	2	2	8	M16	-	33	23	47.5	10	12	25.5	11	35	10	
1220792	2	1	8	-	M16 x 1,5	33	23	47.5	10	12	25.5	11	35	10	
1220793	2	2	8	-	M16 x 1,5	33	23	47.5	10	12	25.5	11	35	10	
1220794	2	1	10	M16	-	33	23	47.5	10	12	25.5	11	35	10	
1220795	2	2	10	M16	-	33	23	47.5	10	12	25.5	11	35	10	
1220796	2	1	10	-	M16 x 1,5	33	23	47.5	10	12	25.5	11	35	10	
1220797	2	2	10	-	M16 x 1,5	33	23	47.5	10	12	25.5	11	35	10	

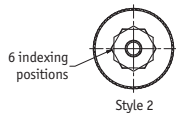

Indexing Plunger with/without Rest Position

SR 6565

- Knob is made from black, matt Polyamide
- Style 1: Without rest position, with locknut
- Style 2: With rest position, with lock nut
- Type 1: Zinc plated steel body and locknut
- Type 2: Stainless Steel body and locknut

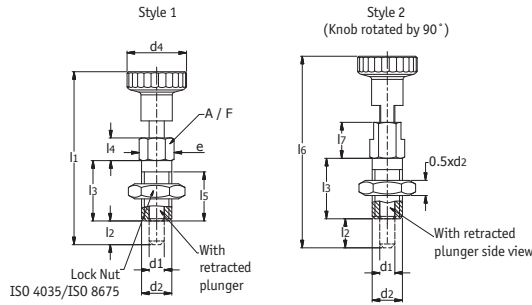

Part Number	Type	Style	Dimensions (mm)													Spring load in N ≈		Standard Pack Quantity
			d1 Plunger h11 Bore +0,03/+0,08	d2	d4	e	l1	l2 min.	l3	l4	l5 min.	l6	l7	A/F	Max. tightening torque in Nm	initial	end	
1220798	1	1	3	M6	12	6.9	30	3.5	12	4.5	10	32.5	7	6	2	3	12	10
1220799	1	1	3	M6 x 0.75	12	6.9	30	3.5	12	4.5	10	32.5	7	6	3	3	12	10
1220800	1	1	4	M6	12	6.9	30.5	4	12	4.5	10	33	7	6	2	3	12	10
1220801	1	1	4	M8 x 1	16	9.2	39.5	4.5	16	6	13.5	43	9.5	8	8	5	24	10
1220803	1	1	5	M8	16	9.2	40	5	16	6	13.5	43.5	9.5	8	7	5	24	10
1220804	1	1	5	M8 x 1	16	9.2	40	5	16	6	13.5	43.5	9.5	8	7	5	24	10
1220802	1	1	5	M10 x 1	18	11.5	42.5	5	16	6	13.5	46	10	10	22	5	24	10
1220805	1	1	6	M10	18	11.5	49	6	20	7.5	17	52	10.5	10	15	5	21	10
1220806	1	1	6	M12 x 1.5	21	13.8	52	6	20	7.5	16.5	55	11	12	38	5	21	10
1220807	1	1	8	M12	21	13.8	59	8	24	9	20.5	63.5	13.5	12	20	6	22	10
1220808	1	1	8	M16 x 1.5	25	19.6	63.5	8	24	9	20.5	68	13.5	17	80	6	22	10
1220809	1	2	3	M6	12	6.9	30	3.5	12	4.5	10	32.5	7	6	2	3	12	10
1220810	1	2	3	M6 x 0.75	12	6.9	30	3.5	12	4.5	10	32.5	7	6	3	3	12	10
1220811	1	2	4	M6	12	6.9	30.5	4	12	4.5	10	33	7	6	2	3	12	10
1220812	1	2	4	M8 x 1	16	9.2	39.5	4.5	16	6	13.5	43	9.5	8	8	5	24	10
1220814	1	2	5	M8	16	9.2	40	5	16	6	13.5	43.5	9.5	8	7	5	24	10
1220815	1	2	5	M8 x 1	16	9.2	40	5	16	6	13.5	43.5	9.5	8	7	5	24	10
1220813	1	2	5	M10 x 1	18	11.5	42.5	5	16	6	13.5	46	10	10	22	5	24	10
1220816	1	2	6	M10	18	11.5	49	6	20	7.5	17	52	10.5	10	15	5	21	10
1220817	1	2	6	M12 x 1.5	21	13.8	52	6	20	7.5	16.5	55	11	12	38	5	21	10
1220818	1	2	8	M12	21	13.8	59	8	24	9	20.5	63.5	13.5	12	20	6	22	10
1220819	1	2	8	M16 x 1.5	25	19.6	63.5	8	24	9	20.5	68	13.5	17	80	6	22	10
1220820	2	1	3	M6	12	6.9	30	3.5	12	4.5	10	32.5	7	6	2	3	12	10
1220821	2	1	3	M6 x 0.75	12	6.9	30	3.5	12	4.5	10	32.5	7	6	3	3	12	10
1220822	2	1	4	M6	12	6.9	30.5	4	12	4.5	10	33	7	6	2	3	12	10
1220823	2	1	4	M8 x 1	16	9.2	39.5	4.5	16	6	13.5	43	9.5	8	8	5	24	10
1220825	2	1	5	M8	16	9.2	40	5	16	6	13.5	43.5	9.5	8	7	5	24	10
1220826	2	1	5	M8 x 1	16	9.2	40	5	16	6	13.5	43.5	9.5	8	7	5	24	10
1220824	2	1	5	M10 x 1	18	11.5	42.5	5	16	6	13.5	46	10	10	22	5	24	10
1220827	2	1	6	M10	18	11.5	49	6	20	7.5	17	52	10.5	10	15	5	21	10
1220828	2	1	6	M12 x 1.5	21	13.8	52	6	20	7.5	16.5	55	11	12	38	5	21	10
1220829	2	1	8	M12	21	13.8	59	8	24	9	20.5	63.5	13.5	12	20	6	22	10
1220830	2	1	8	M16 x 1.5	25	19.6	63.5	8	24	9	20.5	68	13.5	17	80	6	22	10
1220831	2	2	3	M6	12	6.9	30	3.5	12	4.5	10	32.5	7	6	2	3	12	10
1220832	2	2	3	M6 x 0.75	12	6.9	30	3.5	12	4.5	10	32.5	7	6	3	3	12	10
1220833	2	2	4	M6	12	6.9	30.5	4	12	4.5	10	33	7	6	2	3	12	10
1220834	2	2	4	M8 x 1	16	9.2	39.5	4.5	16	6	13.5	43	9.5	8	8	5	24	10
1220836	2	2	5	M8	16	9.2	40	5	16	6	13.5	43.5	9.5	8	7	5	24	10
1220837	2	2	5	M8 x 1	16	9.2	40	5	16	6	13.5	43.5	9.5	8	7	5	24	10
1220835	2	2	5	M10 x 1	18	11.5	42.5	5	16	6	13.5	46	10	10	22	5	24	10
1220838	2	2	6	M10	18	11.5	49	6	20	7.5	17	52	10.5	10	15	5	21	10
1220839	2	2	6	M12 x 1.5	21	13.8	52	6	20	7.5	16.5	55	11	12	38	5	21	10
1220840	2	2	8	M12	21	13.8	59	8	24	9	20.5	63.5	13.5	12	20	6	22	10
1220841	2	2	8	M16 x 1.5	25	19.6	63.5	8	24	9	20.5	68	13.5	17	80	6	22	10

INDEX PLUNGERS

Index Plunger - with fixing plate

SR 5406

Knob: PA 6 - Matt finish

Plate: Zinc Plated Steel C45 grade

Pin: Burnished Steel C45 grade

Spring: 0.65 Carbon Steel

- Ideal for use on thin materials

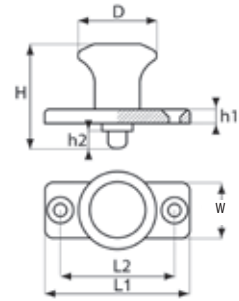

Part Number	Dimensions (mm)							Plunger Diameter	Locking Rest Position	Standard Pack Quantity
	D	H	L1	L2	W	h1	h2			
491266	25	37	40	30	18	4.5	6	6	No	5
491267	31	46	46	34	20	5.5	8	8	No	5
491268	25	37	40	30	18	4.5	6	6	Yes	5
491269	31	46	46	34	20	5.5	8	8	Yes	5

Cam Plungers

SR 5410

Stainless Steel or Burnished Steel

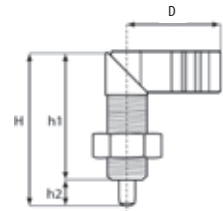

Part Number	Thread Size	Dimensions (mm)				Plunger Diameter	Locking Rest Position	Standard Pack Quantity
		H	D	h1	h2			
491241	M20 x 1.5	69	51	57	12	8	Stainless Steel	2
491242	M20 x 1.5	69	51	57	12	10	Stainless Steel	2
491243	M20 x 1.5	69	51	57	12	12	Stainless Steel	2
491240	M20 x 1.5	69	37	57	12	8	Burnished Steel	2
491238	M20 x 1.5	69	37	57	12	10	Burnished Steel	2
491239	M20 x 1.5	69	37	57	12	12	Burnished Steel	2

Index Plunger – with lift ring

SR 5407

Housing: Nickel Plated Steel

Pin: Stainless Steel

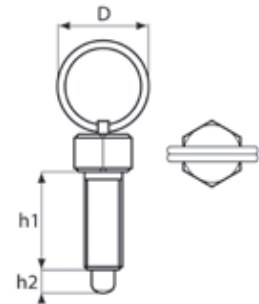

Part Number	Thread Size	Dimensions (mm)			Plunger Diameter	Standard Pack Quantity
		D	h1	h2		
491262	M6	14	12	4	4.0	5
491263	M8	18	16	5	4.5	5
491264	M10	24	20	6	5.5	5
491265	M12	30	24	8	8.0	5

Locking Pins with Axial Lock

SR 6566

Steel Pin, Stainless Steel (AISI 304) pawls, Stainless Steel (AISI 301) Spring

- The two locking pawls can be retracted by pressing the button.
By releasing the button the pawls will be locked again
- The knob, push button and slide are made from plastic

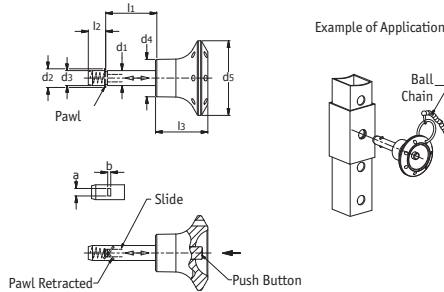

Part Number	Dimensions (mm)										Load in kN ≈ (Double sided shear force)	Standard Pack Quantity
	d1-0,05	l1+0,4 min. size	a	b	d2	d3	d4	d5	l2	l3		
1220885	6	10	2.3	0.5	7.5+0.5	5.9	15	30	7	21	14	5
1220886	6	12	2.3	0.5	7.5+0.5	5.9	15	30	7	21	14	5
1220887	6	16	2.3	0.5	7.5+0.5	5.9	15	30	7	21	14	5
1220888	6	20	2.3	0.5	7.5+0.5	5.9	15	30	7	21	14	5
1220889	6	25	2.3	0.5	7.5+0.5	5.9	15	30	7	21	14	5
1220890	6	30	2.3	0.5	7.5+0.5	5.9	15	30	7	21	14	5
1220891	6	35	2.3	0.5	7.5+0.5	5.9	15	30	7	21	14	5
1220892	6	40	2.3	0.5	7.5+0.5	5.9	15	30	7	21	14	5
1220893	6	45	2.3	0.5	7.5+0.5	5.9	15	30	7	21	14	5
1220894	6	50	2.3	0.5	7.5+0.5	5.9	15	30	7	21	14	5
1220895	8	16	2.8	1	10+0.5	7.9	15	30	8.4	21	28	5
1220896	8	20	2.8	1	10+0.5	7.9	15	30	8.4	21	28	5
1220897	8	25	2.8	1	10+0.5	7.9	15	30	8.4	21	28	5
1220898	8	30	2.8	1	10+0.5	7.9	15	30	8.4	21	28	5
1220899	8	35	2.8	1	10+0.5	7.9	15	30	8.4	21	28	5

Part Number	Dimensions (mm)										Load in kN ≈ (Double sided shear force)	Standard Pack Quantity
	d1-0,05	l1+0,4 minimum size	a	b	d2	d3	d4	d5	l2	l3		
1220900	8	40	2.8	1	10+0.5	7.9	15	30	8.4	21	28	5
1220901	8	45	2.8	1	10+0.5	7.9	15	30	8.4	21	28	5
1220902	8	50	2.8	1	10+0.5	7.9	15	30	8.4	21	28	5
1220903	10	20	3.3	1	12+1	9.9	18	34	9.8	26	38	5
1220904	10	25	3.3	1	12+1	9.9	18	34	9.8	26	38	5
1220905	10	30	3.3	1	12+1	9.9	18	34	9.8	26	38	5
1220906	10	35	3.3	1	12+1	9.9	18	34	9.8	26	38	5
1220907	10	40	3.3	1	12+1	9.9	18	34	9.8	26	38	5
1220908	10	45	3.3	1	12+1	9.9	18	34	9.8	26	38	5
1220909	10	50	3.3	1	12+1	9.9	18	34	9.8	26	38	5
1220910	10	60	3.3	1	12+1	9.9	18	34	9.8	26	38	5
1220911	12	25	3.8	1	14+1	11.9	18	34	11.3	26	61	5
1220912	12	30	3.8	1	14+1	11.9	18	34	11.3	26	61	5
1220913	12	35	3.8	1	14+1	11.9	18	34	11.3	26	61	5
1220914	12	40	3.8	1	14+1	11.9	18	34	11.3	26	61	5
1220915	12	45	3.8	1	14+1	11.9	18	34	11.3	26	61	5
1220916	12	50	3.8	1	14+1	11.9	18	34	11.3	26	61	5
1220917	12	60	3.8	1	14+1	11.9	18	34	11.3	26	61	5
1220918	12	70	3.8	1	14+1	11.9	18	34	11.3	26	61	5
1220919	12	80	3.8	1	14+1	11.9	18	34	11.3	26	61	5
1220920	16	30	4.8	1.2	19+1	15.9	22	40	14.2	32	113	5
1220921	16	35	4.8	1.2	19+1	15.9	22	40	14.2	32	113	5
1220922	16	40	4.8	1.2	19+1	15.9	22	40	14.2	32	113	5
1220923	16	45	4.8	1.2	19+1	15.9	22	40	14.2	32	113	5
1220924	16	50	4.8	1.2	19+1	15.9	22	40	14.2	32	113	5
1220925	16	60	4.8	1.2	19+1	15.9	22	40	14.2	32	113	5
1220926	16	70	4.8	1.2	19+1	15.9	22	40	14.2	32	113	5
1220927	16	80	4.8	1.2	19+1	15.9	22	40	14.2	32	113	5
1220928	20	30	4.8	1.2	23+1	19.8	25	40	14.8	33	187	5
1220929	20	35	4.8	1.2	23+1	19.8	25	40	14.8	33	187	5
1220930	20	40	4.8	1.2	23+1	19.8	25	40	14.8	33	187	5
1220931	20	45	4.8	1.2	23+1	19.8	25	40	14.8	33	187	5
1220932	20	50	4.8	1.2	23+1	19.8	25	40	14.8	33	187	5
1220933	20	60	4.8	1.2	23+1	19.8	25	40	14.8	33	187	5
1220934	20	70	4.8	1.2	23+1	19.8	25	40	14.8	33	187	5
1220935	20	80	4.8	1.2	23+1	19.8	25	40	14.8	33	187	5

Spring Latches Weldable

SR 6567

- A groove will hold the latch in both positions
- The square bar allows the Spring Latch to be welded in any desired position
- Latch and Plunger is made from zinc plated steel

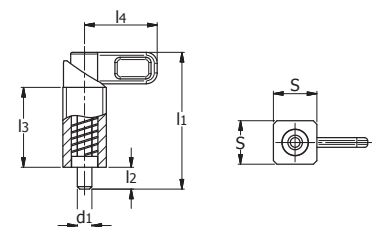

Part Number	d1 Plunger -0,05/-0,25 Bore +0,1/+0,3	Dimensions (mm)				Spring load in N ≈		Standard Pack Quantity	
		s	l1 ≈	l2	l3	l4	Initial		End
1220939	8	20	68	14	35	37	16	55	5
1220936	10	20	68	14	35	37	16	55	5
1220937	12	20	68	14	35	37	16	55	5
1220938	14	20	68	14	35	37	16	55	5

INDEX PLUNGERS

Spring Latches with Horizontal Flange

SR 6568



- A groove will hold the latch in both positions
- The Guide is made from zinc plated steel and has a plastic coated, black, textured finish
- The Latch and Plunger is made from zinc plated steel
- Type 1: The Latch position is right-angled to the fixing holes
- Type 2: The latch position is parallel to the fixing holes

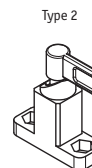
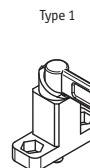
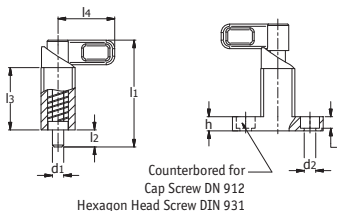
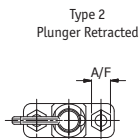
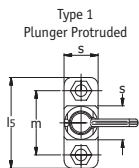

Part Number	Type	d1 Plunger -0,05/-0,25 Bore +0,1/+0,3	Dimensions (mm)											Spring load in N ≈		Standard Pack Quantity
			s	d2+0,2	h	l1 ≈	l2	l3	l4	l5	m	A/F	t	Initial	End	
1220946	1	8	20	6.1	7.5	68	14	35	37	48	34	10	6.1	16	55	5
1220947	2	8	20	6.1	7.5	68	14	35	37	48	34	10	6.1	16	55	5
1220940	1	10	20	6.1	7.5	68	14	35	37	48	34	10	6.1	16	55	5
1220941	2	10	20	6.1	7.5	68	14	35	37	48	34	10	6.1	16	55	5
1220942	1	12	20	6.1	7.5	68	14	35	37	48	34	10	6.1	16	55	5
1220943	2	12	20	6.1	7.5	68	14	35	37	48	34	10	6.1	16	55	5
1220944	1	14	20	6.1	7.5	68	14	35	37	48	34	10	6.1	16	55	5
1220945	2	14	20	6.1	7.5	68	14	35	37	48	34	10	6.1	16	55	5

Spring Latches with Vertical Flange

SR 6569



- A groove will hold the latch in both positions
- The Guide is made from zinc plated steel and has a plastic coated, black, textured finish
- The Latch and Plunger is made from zinc plated steel
- Type 1: The Latch has a left indexing cam
- Type 2: The latch has a right indexing cam

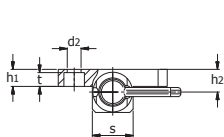

Type 1

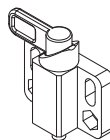
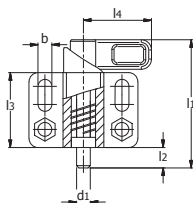

Type 2

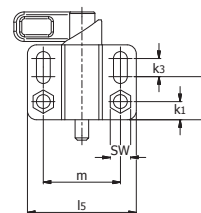

Part Number	Type	d1 Plunger -0,05/-0,25 Bore +0,1/+0,3	Dimensions (mm)														Spring load in N ≈		Standard Pack Quantity		
			s	b +0,3	d2 +0,2	h1	h2	k1	k2	k3	l1 ≈	l2	l3	l4	l5	m	A/F	t		Initial	End
1220954	1	8	20	6.1	6.1	7.5	10	7.5	18	12	68	14	35	37	48	34	10	6.1	16	55	5
1220955	2	8	20	6.1	6.1	7.5	10	7.5	18	12	68	14	35	37	48	34	10	6.1	16	55	5
1220948	1	10	20	6.1	6.1	7.5	10	7.5	18	12	68	14	35	37	48	34	10	6.1	16	55	5
1220949	2	10	20	6.1	6.1	7.5	10	7.5	18	12	68	14	35	37	48	34	10	6.1	16	55	5
1220950	1	12	20	6.1	6.1	7.5	10	7.5	18	12	68	14	35	37	48	34	10	6.1	16	55	5
1220951	2	12	20	6.1	6.1	7.5	10	7.5	18	12	68	14	35	37	48	34	10	6.1	16	55	5
1220952	1	14	20	6.1	6.1	7.5	10	7.5	18	12	68	14	35	37	48	34	10	6.1	16	55	5
1220953	2	14	20	6.1	6.1	7.5	10	7.5	18	12	68	14	35	37	48	34	10	6.1	16	55	5

Positioning Bushings with Ramping Cone

SR 6570

Hardened Steel

- Positioning Bushings with Ramping Cone are for use with bolts of Indexing Plungers and Cam Action Indexing Plungers
- The threads are adapted to fit the Mounting Blocks

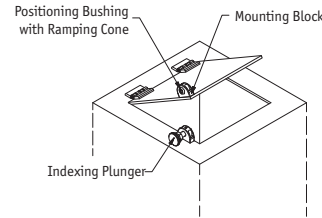
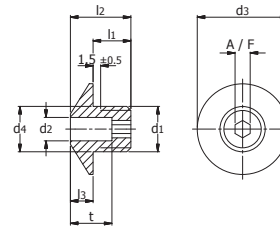

Part Number	Dimensions (mm)										Standard Pack Quantity
	d1	d2+0,1 Bore	d3	d4-0,05	l1	l2	l3	A/F	t		
1220866	M12 x 1.5	B 5.2	24	12	10	16	5	4	11	5	
1220867	M12 x 1.5	B 6.2	24	12	10	16	5	4	11	5	
1220869	M16 x 1.5	B 8.2	32	16	12	20	7	6	13	5	
1220868	M16 x 1.5	B 10.2	32	16	12	20	7	6	13	5	

Indexing Plungers

SR 6571

Stainless Steel

- Type 1: Indexing Plunger without rest position. With lifting ring
- Type 2: Indexing Plunger without rest position. With knob
- Type 3: Indexing Plunger with rest position. With knob
- The guide is made from die casted zinc with a black, plastic coated, textured finish
- The Plunger is made from Stainless Steel AISI 303. Spring and Lifting Ring (if applicable) are made from Stainless Steel AISI 301
- The knob is made from black, matt, Polyamide PA

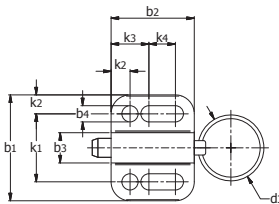

Without Rest Position, with Ring

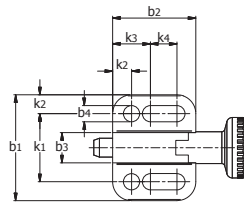

With Rest Position, with Knob

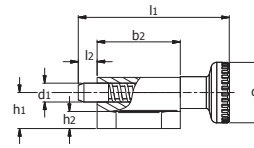

Part Number	Type	Dimensions (mm)															Spring load in N ≈		Standard Pack Quantity
		d1 Plunger h11 Bore +0,03/+0,08	d2	d3	b1	b2	b3	b4-0,2	h1	h2	k1 ±0,05	k2	k3	k4	l1	l2 ±0,5	Initial	End	
1220870	1	4	12	14	22	16.5	6	3.3	7	4	14	4	8	4.5	30.5	4	3	12	10
1220871	2	4	12	14	22	16.5	6	3.3	7	4	14	4	8	4.5	30.5	4	3	12	10
1220872	3	4	12	-	22	19	6	3.3	7	4	14	4	8	7	33	4	3	12	10
1220873	1	5	16	18	28	22	8	4.3	9.5	4.5	18	5	10	7	40	5	5	24	10
1220874	2	5	16	18	28	22	8	4.3	9.5	4.5	18	5	10	7	40	5	5	24	10
1220875	3	5	16	-	28	25.5	8	4.3	9.5	4.5	18	5	10	10.5	43.5	5	5	24	10
1220876	1	6	18	24	32	27.5	10	5.4	10.5	5	21	5.5	12	10	49	6	5	21	10
1220877	2	6	18	24	32	27.5	10	5.4	10.5	5	21	5.5	12	10	49	6	5	21	10
1220878	3	6	18	-	32	30.5	10	5.4	10.5	5	21	5.5	12	13	52	6	5	21	10
1220879	1	8	21	30	34	33	12	5.4	12.5	6	23	5.5	12	15.5	59	8	6	22	10
1220880	2	8	21	30	34	33	12	5.4	12.5	6	23	5.5	12	15.5	59	8	6	22	10
1220881	3	8	21	-	34	37.5	12	5.4	12.5	6	23	5.5	12	20	63.5	8	6	22	10
1220882	1	10	25	30	39	35	14.5	6.5	14.5	6	27	6	15	13.5	67.5	10	4	25	10
1220883	2	10	25	30	39	35	14.5	6.5	14.5	6	27	6	15	13.5	67.5	10	4	25	10
1220884	3	10	25	-	39	40	14.5	6.5	14.5	6	27	6	15	18.5	72.5	10	4	25	10

INDEX PLUNGERS

Cam Action Indexing Plungers

SR 6572

Zinc plated steel, PA lever

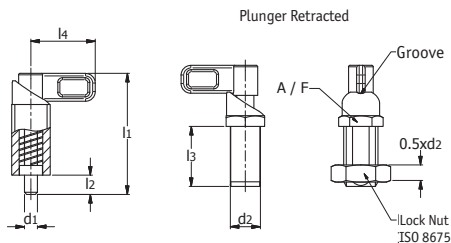

- Cam Action Indexing Plungers are used in applications where the locking pin must not protrude all the time
- The threaded body is made from zinc die casting

Part Number	Dimensions (mm)							Spring load in N \approx		Standard Pack Quantity
	d1 Plunger -0,05 Bore +0,1/+0,05	d2	l1	l2	l3	l4	A/F	Initial	End	
1220845	4	M12 x 1.5	48	8	25	25	13	8	22	5
1220846	5	M12 x 1.5	48	8	25	25	13	8	22	5
1220847	6	M12 x 1.5	48	8	25	25	13	8	22	5
1220848	6	M16 x 1.5	56.5	10	28	30	18	11	30	5
1220849	8	M16 x 1.5	56.5	10	28	30	18	11	30	5
1220850	8	M20 x 1.5	69.5	12	36	37	22	20	56	5
1220842	10	M16 x 1.5	56.5	10	28	30	18	11	30	5
1220843	10	M20 x 1.5	69.5	12	36	37	22	20	56	5
1220844	12	M20 x 1.5	69.5	12	36	37	22	20	56	5

Mounting Blocks

SR 6573

Black powder coated Die cast zinc

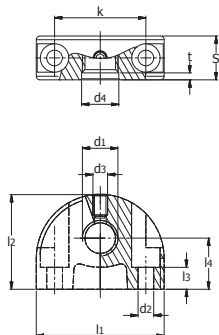
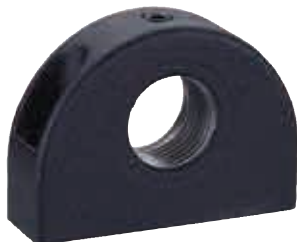

- Mounting Blocks are a fitting aid for Cam Action Indexing Plungers and for setting bolts and buffers
- Made from Zinc Die Casting with a Black Powder Coated, textured finish

Part Number	Dimensions (mm)											Standard Pack Quantity
	l1	d1	d2	d3	d4	k	l2	l3	l4	s	t	
1220855	35	M8	4.3	M4	8.2	25	26	6	14	12	2	5
1220856	35	M8 x 1	4.3	M4	8.2	25	26	6	14	12	2	5
1220851	35	M10	4.3	M4	10.2	25	26	6	14	12	2	5
1220852	35	M10 x 1	4.3	M4	10.2	25	26	6	14	12	2	5
1220853	35	M12	4.3	M4	12.2	25	26	6	14	12	3	5
1220854	35	M12 x 1.5	4.3	M4	12.2	25	26	6	14	12	3	5
1220857	47	M16	5.3	M5	16.2	35	34	10	18	14	3	5
1220858	47	M16 x 1.5	5.3	M5	16.2	35	34	10	18	14	3	5
1220859	47	M20 x 1.5	5.3	M5	20.2	35	34	10	18	14	3	5

Positioning Bushings

SR 6574

Hardened steel

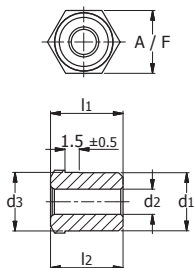

- Positioning Bushings are for use with the bolts of the Cam Action Indexing Plungers and Indexing Plungers
- The threads are adapted to fit the Mounting Blocks
- Made from hardened steel

Part Number	Dimensions (mm)						Standard Pack Quantity
	d1	d2+0,1 Bore	d3-0,05	l1-0,2	l2	A/F	
1220860	M12 x 1.5	B 4.2	12	10	13	13	5
1220861	M12 x 1.5	B 5.2	12	10	13	13	5
1220862	M12 x 1.5	B 6.2	12	10	13	13	5
1220865	M16 x 1.5	B 8.2	16	12	15	17	5
1220863	M16 x 1.5	B 10.2	16	12	15	17	5
1220864	M16 x 1.5	B 12.2	16	12	15	17	5

Index Plunger – Metal Head

SR 5408

Body: Zinc Plated or Stainless Steel

Head: Zinc Plated, Die-Cast Zinc

- Matte Finish

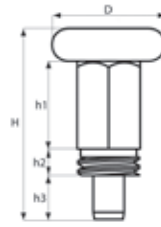

Part Number	Thread Size	Dimensions (mm)					Plunger Diameter	Locking Rest Position	Insert Material	Standard Pack Quantity
		D	H	h1	h2	h3				
497510	M10 x 1.0	18.2	30.4	18.2	4.0	7.0	6.0	No	Zinc Plated	5
497511	M10 x 1.0	18.2	30.4	18.2	4.0	7.0	6.0	Yes	Zinc Plated	5
497512	M12 x 1.75	24.0	39.4	19.2	8.0	7.0	7.0	No	Zinc Plated	5
497513	M12 x 1.75	24.0	39.4	19.2	8.0	7.0	7.0	Yes	Zinc Plated	5
497514	M10 x 1.0	18.2	30.4	18.2	4.0	7.0	6.0	No	Stainless Steel	2
497515	M10 x 1.0	18.2	30.4	18.2	4.0	7.0	6.0	Yes	Stainless Steel	2

Spring Loaded Plunger

SR5515

Aluminium

- Simplified positioning of sliding components
- Quick-release hinge for removable door
- Fast installation and removal of components
- Low carbon steel stud
- Zinc-plated steel shell and stainless steel spring
- Thread-in style

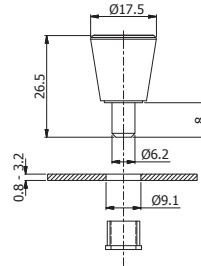

Part Number	Finish	Standard Pack Quantity
497562	Bright Chrome	20
497563	Powder Black	20

THERE'S MORE ONLINE!

- Buy online
- Request free samples
- Easy to find products
- Download 3D CAD files

www.essentracomponents.co.uk



SPRING PLUNGERS

Ball and Spring Index Plunger

SR 5409



Burnished Steel: Ball Bearing - Steel, Spring - Steel,
Outer Casing - SS304

Stainless Steel: Ball - SS304, Spring - SS304, Outer Casing - SS304

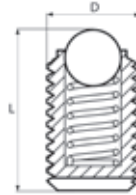

Part Number	Dimensions		Material	Standard Pack Quantity
	D	L		
491244	M3	7.0	Burnished Steel	20
491245	M4	10.0	Burnished Steel	20
491246	M5	13.0	Burnished Steel	20
491247	M6	15.0	Burnished Steel	20
491248	M8	17.5	Burnished Steel	20
491249	M10	21.0	Burnished Steel	20
491250	M12	24.5	Burnished Steel	10
491251	M16	27.5	Burnished Steel	10
491252	M20	34.0	Burnished Steel	10
491253	M3	7.5	Stainless Steel	20
491254	M4	10.0	Stainless Steel	20
491255	M5	13.0	Stainless Steel	20
491256	M6	15.0	Stainless Steel	20
491257	M8	17.5	Stainless Steel	20
491258	M10	21.0	Stainless Steel	20
491259	M12	24.5	Stainless Steel	10
491260	M16	27.5	Stainless Steel	10
491261	M20	34.0	Stainless Steel	10

Spring Plungers

SR 6575

Stainless Steel



- Used as detents as well as for push-on and push-off applications and ejectors
- A tolerance of H7 for the location hole of d1 is recommended
- Due to different production methods, the dimensions l2 and l3 will vary
- Available in type 1 - Stainless Steel Housing and Ball - AISI 305/20c
- Available in type 2 - Plastic Housing and Stainless Steel Ball

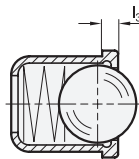
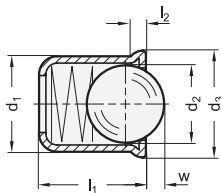

Type 1

Type 2

Part Number	Dimensions						Standard Pack Quantity
	d1 +0,1	d2	d3	l1 ≈	l2 ≈	W	
1337673	3	2.4	3.5	4	0.75	0.7	50
1337674	4	3	4.6	5	0.9	1	50
1337675	5	4	5.6	6	0.9	1.4	50
1337676	6	5	6.5	7	1	1.8	50
1337677	8	6.5	8.5	9	1.1	2.4	50
1337678	10	8.5	11	13	1.6	3.3	25
1337679	12	10	13	16	2.3	4	25

Part Number	Dimensions					Standard Pack Quantity
	d1 +0,1	d2	d3	l1 ≈	l3 ±0,1	
1337680	3	3.5	3.5	4	0.6	50
1337681	4	4.6	4.6	5	1	50
1337682	5	5.6	5.6	6	1.4	50
1337683	6	6.5	6.5	7	1.8	50
1337684	8	8.5	8.5	9	2.4	50
1337685	10	11	11	13.5	3.3	25
1337686	12	13	13	16	4	25

Grub Pins

SR 6576

Steel and Polyacetal POM

- Grub pins are used in applications, where marks and damages on the workpiece are unwanted
- Screw steel with a Tensile Strength class 5.8 (500 N/mm²)
- Thrust pad made from Polyacetal POM (Plastic)



Part Number	Dimensions				Standard Pack Quantity
	d1	l1	d3	A/F	
1337608	M4	6	0.5	2	50
1337609	M4	8	0.5	2	50
1337610	M4	10	0.5	2	50
1337611	M5	8	0.5	2.5	50
1337612	M5	12	0.5	2.5	50
1337613	M5	16	0.5	2.5	50
1337614	M5	20	0.5	2.5	50
1337615	M6	10	1	3	50
1337616	M6	12	1	3	50
1337617	M6	16	1	3	50
1337618	M6	20	1	3	50
1337619	M6	25	1	3	50
1337620	M6	32	1	3	50
1337621	M8	25	1.5	4	50
1337622	M8	32	1.5	4	50
1337623	M8	40	1.5	4	50
1337624	M8	50	1.5	4	50
1337625	M8	63	1.5	4	50

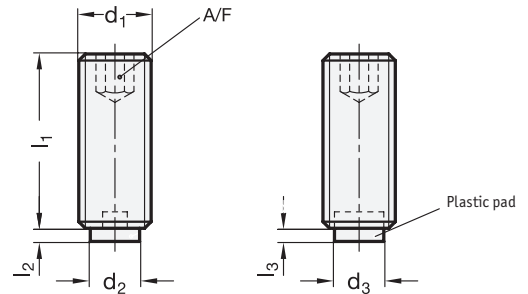

Retaining Cables

SR 6577

Stainless Steel

- Coated with clear plastic PVC

Type A – Two Loop

Part Number	Dimensions			Static load in N ≈	Standard Pack Quantity
	l	d1	d2		
1337524	150	14	1	50	1
1337525	150	24	1.5	100	1
1337526	150	30	1.8	120	1
1337527	200	14	1	50	1
1337528	200	24	1.5	100	1
1337529	200	30	1.8	120	1
1337530	320	14	1	50	1
1337531	320	24	1.5	100	1
1337532	320	30	1.8	120	1
1337533	500	14	1	50	1
1337534	500	24	1.5	100	1
1337535	500	30	1.8	120	1



Type B – Tab and Loop

Part Number	Dimensions			Static load in N ≈	Standard Pack Quantity
	l	d1	d2		
1337536	150	14	1	50	1
1337537	150	24	1.5	100	1
1337538	150	30	1.8	120	1
1337539	200	14	1	50	1
1337540	200	24	1.5	100	1
1337541	200	30	1.8	120	1
1337542	320	14	1	50	1
1337543	320	24	1.5	100	1
1337544	320	30	1.8	120	1
1337545	500	14	1	50	1
1337546	500	24	1.5	100	1
1337547	500	30	1.8	120	1

Example of application

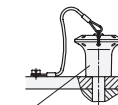

Pin Ball lock pins

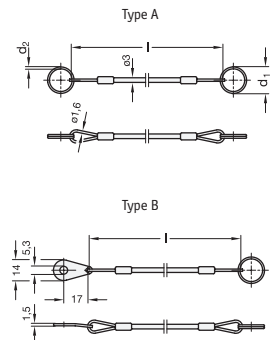

LEVELS AND COLLARS

Bulls Eyes Levels

SR 6579

Aluminium

- Most commonly used to check the horizontal position of jigs, machines, devices, appliances and instruments
- The housing is grooved making it easier to mount
- Mounting flange available in
 - Type 1 for bolting to surface
 - Type 2 for inserting (collar)
- Without bore available in Anodized finish with Colourless/transparent Fluid Colour
- With bore available in both anodized natural Colour, both with a transparent/colour Fluid

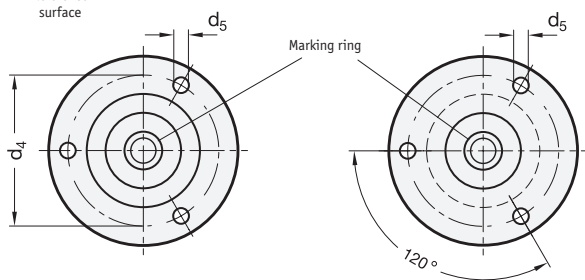
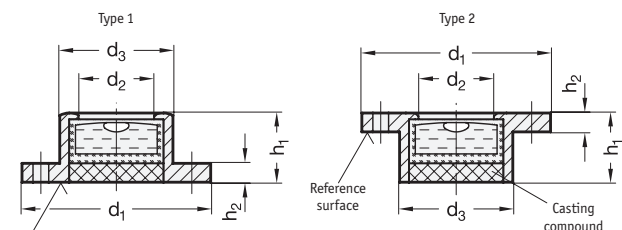

Type 1

Part Number	Dimensions								Standard Pack Quantity
	d1	d2	d3	d4	d5	h1	h2	h3	
1337486	20	10	14	17	1.8	10	1.8		2
1337487	30	12	18	24	3.2	11	3		2
1337488	40	20	28	34.5	3.2	14	4		2
1337489	50	25	34	43	3.2	15	5		2
1337490	20	10	14	17	1.8	10	1.8		2
1337491	30	12	18	24	3.2	11	3		2
1337492	40	20	28	34.5	3.2	14	4		2
1337493	50	25	34	43	3.2	15	5		2

Type 2

Part Number	Material Finish	Dimensions					Standard Pack Quantity
		d1	d2	"d3 -0,05 -0,15"	h1	h2	
1337494	Anodized Natural Color	20	12	18	10	8	2
1337495	Anodized Natural Color	25	14	20	12	9	2
1337496	Anodized Natural Color	30	20	28	13	10	2
1337497	Anodized Black	20	12	18	10	8	2
1337498	Anodized Black	25	14	20	12	9	2
1337499	Anodized Black	30	20	28	13	10	2

Screw on Level

SR 6578

Aluminium

- Available in silver RAL 9006 & Black RAL 9005
- Powder coated, black RAL 9005
- Fluid Colour – Green/Transparent

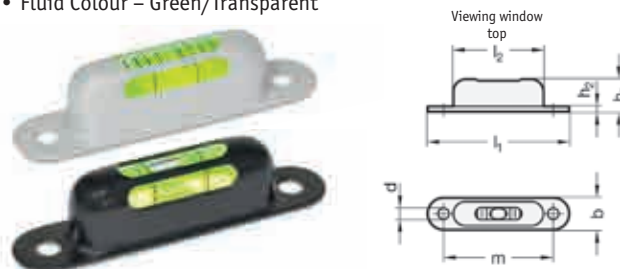

Part Number	Colour	Dimensions							Sensitivity	Standard Pack Quantity
		l1	b	d	h1	h2	l2	m		
1337500	Silver	57	12	4.5	13	1	37	45	50	2
1337501	Silver	57	12	4.5	13	1	37	45	6	2
1337502	Black	57	12	4.5	13	1	37	45	50	2
1337503	Black	57	12	4.5	13	1	37	45	6	2

Oil Sight Glasses

SR 6580

Aluminium – with contrast screen

- Oil level sight glasses offer genuine glass of high stability and scratch proof
- The seal is housed in a groove and it can therefore not be lost. In addition, this groove prevents the seal from being extruded when the sight glass is tightened.

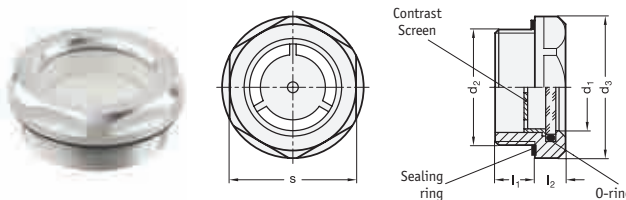

Part Number	Dimensions						Standard Pack Quantity
	d1	d2	d3	l1	l2	s	
1337687	7	M14 x 1.5	20	7.5	6.5	18	1
1337688	11	M16 x 1.5	22	8	7.5	20	1
1337689	14	M20 x 1.5	26	8.5	7.5	23	1
1337690	18	M26 x 1.5	32	9	8	30	1
1337691	18	M27 x 1.5	32	9	8	30	1
1337692	24	M33 x 1.5	40	11	8.5	36	1
1337693	32	M40 x 1.5	50	12	9	46	1
1337694	32	M42 x 1.5	50	13	9	46	1
1337695	7	G 1/4	20	7.5	6.5	18	1
1337696	11	G 3/8	22	8	7.5	20	1
1337697	14	G 1/2	26	8.5	7.5	23	1
1337698	18	G 3/4	32	9	8	30	1
1337699	24	G 1	40	11	8.5	36	1
1337700	32	G 1 1/4	50	12	9	46	1