

DATA SHEET

GAS DISCHARGE TUBES TELEPHONE INTERFACE

3R-6 series

RoHS compliant & free



Product specification—April 26, 2021 V.1



Gas Discharge Tube (GDT) Data Sheet

Features

- Provide ultra-fast response to surge voltage from slow-rising surge of 100V/s to rapid-rising surge of 1KV/μs
- Stable breakdown voltage
- High insulation resistance
- Low capacitance (≤2pF)
- High holdover voltage
- Large absorbing transient current capability
- Micro-Gap Design
- Size: 6.0mm*8.5mm
- Storage and operating temperature: -40°C ~ +85°C
- Meets MSL level 1, per J-STD-020
- Safety certification: UL



Applications

- Repeaters, Modems
- Telephone Interface, Line cards
- Data communication equipment
- Line test equipment

Part Number Code

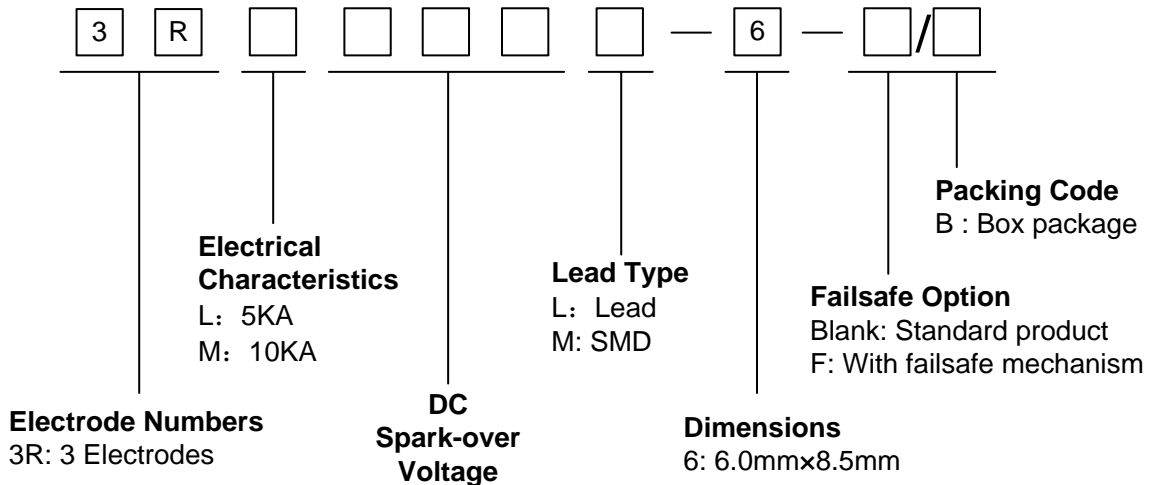

Ordering Code	Lead type	Failsafe option	Package
3RLXXXL-6/B 3RMXXXL-6/B	Lead		Box(Tray)
3RLXXXL-6-F/B 3RMXXXL-6-F/B	Lead	With failsafe mechanism	Box(Tray)
3RLXXXM-6 3RMXXXM-6	SMD		Tape & Reel

Marking

B : BrightKing Logo

3RL090-6 : Device Marking Code

XXXX : Internal Control Code

Dimensions

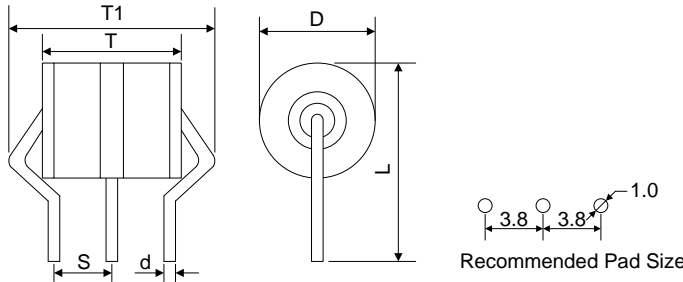
L Type	Symbol	Dimension (mm)	
		Spec.	Tolerance
	D	6.0	+0.2, -0.5
	T	8.5	±0.5
	T1	15.0	Max.
	L	16.0	Max.

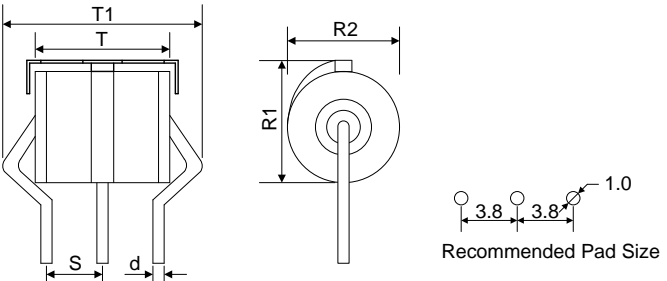
	S	3.8	±0.3
	d	0.8	±0.1
	R1	7.8	±0.4
	R2	6.3	±0.3

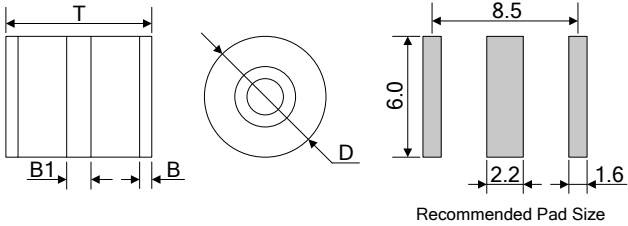
	D	6.0	±0.2
	T	8.5	±0.5
	B	1.0	±0.1
	B1	1.5	±0.2

Electrical Characteristics (3RL-6)

Part Number		DC Spark-over Voltage	Maximum Impulse Spark-over Voltage	Nominal Impulse Discharge Current	Alternating Discharge Current	Impulse Life	Minimum Insulation Resistance		Maximum Capacitance	Device Marking Code
		100V/s	1000V/μs	8/20μs 10times	50Hz, 1sec	10/1000μs 100A	Test Voltage	(GΩ)	1MHz	
		(V)	(V)	(KA)	(A)	(times)	DC(V)		(pF)	
3RL075L-6	3RL075M-6	75±20%	750	5.0	5.0	200	25	1.0	2.0	3RL075-6
3RL090L-6	3RL090M-6	90±20%	750	5.0	5.0	200	50	1.0	2.0	3RL090-6
3RL150L-6	3RL150M-6	150±20%	800	5.0	5.0	200	100	1.0	2.0	3RL150-6
3RL230L-6	3RL230M-6	230±20%	800	5.0	5.0	200	100	1.0	2.0	3RL230-6
3RL250L-6	3RL250M-6	250±20%	800	5.0	5.0	200	100	1.0	2.0	3RL250-6
3RL300L-6	3RL300M-6	300±20%	900	5.0	5.0	200	100	1.0	2.0	3RL300-6
3RL350L-6	3RL350M-6	350±20%	900	5.0	5.0	200	100	1.0	2.0	3RL350-6
3RL470L-6	3RL470M-6	470±20%	950	5.0	5.0	200	250	1.0	2.0	3RL470-6
3RL600L-6	3RL600M-6	600±20%	1300	5.0	5.0	200	250	1.0	2.0	3RL600-6

Electrical Characteristics (3RM-6)

Part Number		DC Spark-over Voltage	Maximum Impulse Spark-over Voltage	Nominal Impulse Discharge Current	Alternating Discharge Current	Impulse Life	Minimum Insulation Resistance		Maximum Capacitance	Device Marking Code
		100V/s	1000V/ μ s	8/20 μ s 10times	50Hz, 1sec	10/1000 μ s 100A	Test Voltage	(G Ω)	1MHz	
		(V)	(V)	(KA)	(A)	(times)	DC(V)		(pF)	
3RM075L-6	3RM075M-6	75 \pm 20%	750	10	10	300	25	1.0	2.0	3RM075-6
3RM090L-6	3RM090M-6	90 \pm 20%	750	10	10	300	50	1.0	2.0	3RM090-6
3RM150L-6	3RM150M-6	150 \pm 20%	800	10	10	300	100	1.0	2.0	3RM150-6
3RM230L-6	3RM230M-6	230 \pm 20%	800	10	10	300	100	1.0	2.0	3RM230-6
3RM250L-6	3RM250M-6	250 \pm 20%	800	10	10	300	100	1.0	2.0	3RM250-6
3RM300L-6	3RM300M-6	300 \pm 20%	900	10	10	300	100	1.0	2.0	3RM300-6
3RM350L-6	3RM350M-6	350 \pm 20%	900	10	10	300	100	1.0	2.0	3RM350-6
3RM470L-6	3RM470M-6	470 \pm 20%	950	10	10	300	250	1.0	2.0	3RM470-6
3RM600L-6	3RM600M-6	600 \pm 20%	1300	10	10	300	250	1.0	2.0	3RM600-6

Electrical Ratings

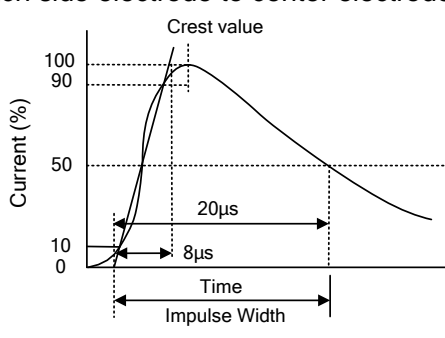
Items	Test Condition/Description	Requirement
DC Spark-over Voltage	The voltage is measured with voltage ramp $dv/dt=100V/s$. Test is between each side electrode and center electrode.	To meet the specified value
Maximum Impulse Spark-over Voltage	The maximum impulse spark-over voltage is measured with voltage ramp $dv/dt=1000V/\mu s$. Test is between each side electrode and center electrode.	
Impulse Discharge Current	Maximum surge current that can be applied through center electrode with 8/20 μs waveform, for 10 times with 3min interval time, which will be equally divided between each side electrode to center electrode. 	
Alternating Discharge Current	Rated RMS value of AC current at 50Hz, 1 sec. for 10 times with interval time 3 min. Test is between each side electrode and center electrode.	
Insulation Resistance	The resistance of gas tube shall be measured between each side electrodes and center electrode.	
Capacitance	The capacitance of gas tube shall be measured between each side electrodes and center electrode. Test frequency: 1MHz	

Recommended Soldering Conditions

Wave Soldering

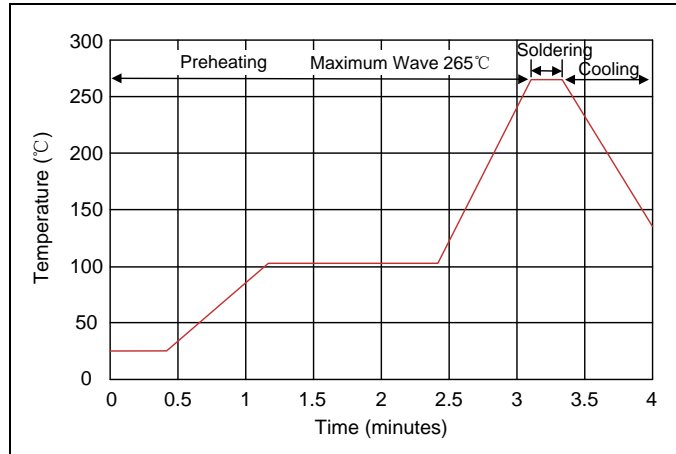

Item	Conditions
Peak Temperature	265°C
Dipping Time	10 seconds
Soldering	1 time

Reflow Soldering

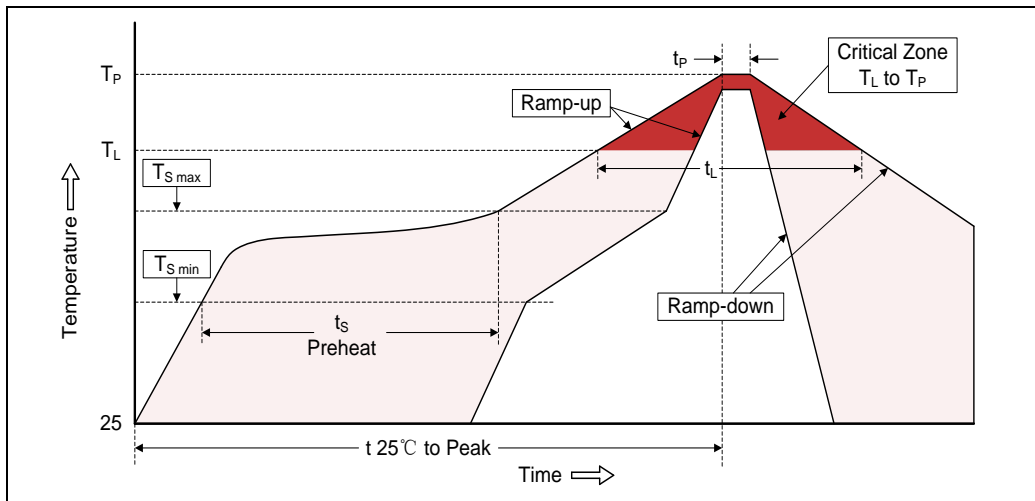

Profile Feature	Pb-Free Assembly
Average ramp-up rate (TL to TP)	3°C/second max.
Preheat -Temperature Min (TSmin) -Temperature Max (TSmax) -Time (min to max) (ts)	150°C 200°C 60-180 seconds
TSmax to TL -Ramp-up Rate	3°C/second max.
Time maintained above: -Temperature (TL) -Time (tL)	217°C 60-150 seconds
Peak Temperature (TP)	260°C
Time within 5°C of actual Peak Temperature (tp)	20-40 seconds
Ramp-down Rate	6°C/second max.
Time 25°C to Peak Temperature	8 minutes max.