

Description

Single pole, miniaturised thermal circuit breaker with trip-free mechanism and push/pull on/off manual actuation (M-type TO CBE to EN 60934). Threadneck panel mounted, temperature-compensated, with optional auxiliary contacts. Fully approved for commercial aircraft and similar requirements.

Various dummies are available without protective function, allowing connection of pre-installed wiring without loads.

Typical applications

Extra low voltage wiring systems on all types of vehicles for land, sea and air.

Ordering information

Type No.

4120 single pole, with temperature compensation

Mounting

G threadneck panel mounting

Threadneck design

1 M12x1x6.3 (aluminium)

2 7/16-32 UNx6.3 (aluminium)

Number of poles

1 1-pole, thermally protected

Hardware for threadneck

0 without hardware

1 hex nut M12x1, corrugated washer 12/15, fitted

3 hex nut M12x1 (aluminium), serrated lock washer 12.1/17.2, bulk shipped

4 hex nut 7/16-32UN (aluminium), serrated lock washer 11.3/14.9, fitted

Terminal design (main terminals)

K1 screw terminals with metric thread K14 (M4)

J1 screw terminals with inch thread J14 (8-32UNC-2B)

J2 screw terminals with inch thread J17 (8-32UNC-2B)

J3 screw terminals with inch thread J25 (6-32UNC-2B)

P1 blade terminals 6.3x0.8, DIN 46244, silver-plated

Characteristic curve

M1 thermal, 1.15 - 1.4 I_N

Terminal screws

A Phillips screw M4x6, fitted

B Phillips screw 8-32UNC-2Ax6, fitted

C Phillips screw 6-32UNC-2Ax6 (MS 51957-26)

K hex screw with Phillips head 8-32UNC-3Ax7.6, fitted

M hex screw with Phillips head 8-32UNC-3Ax7.6, bulk shipped

Z without terminal hardware

Terminal washers

0 without lock washer

1 wave washer A4, fitted

2 lock washer 4.3, fitted

4 lock washer 3.7 (MS 35338-136)

5 lock washer 4.3/9, fitted

6 lock washer 4.3/9, bulk shipped

Auxiliary contact

S0 without auxiliary contact

S1 with auxiliary contact (connector EN 3155-016M2018) (NC)

S5 with polarized auxiliary contact (NC)

Barrier

Z without barrier

Colour of the push button

G green to EN (e. g. 2 1/2)

N black to EN (e. g. 2 1/2)

Current ratings

1...25 A

4120 - G 1 1 1 - K1 M1 - A 1 S0 Z N - 10 A ordering example

Please be informed that we have minimum ordering quantities to be observed.



4120-...

Technical data

For further details please see: www.e-t-a.de/ti_e

Voltage rating	AC 115 V (300 Hz to 800 Hz); DC 28 V	
Current rating range	1...25 A	
Auxiliary circuit	1 A, DC 28 V	
Typical life	20,000 operations mechanical, or 5,000 operations at 1 x I _N	
Ambient temperature	-55°C ...+125°C (-67...+257 °F)	
Insulation co-ordination (IEC 60664 and 60664A)	rated impulse withstand voltage	pollution degree
	1.5 kV	3
Dielectric strength (IEC 60664 and 60664A)	test voltage	
	AC 1,500 V	
	operating area	
	main to aux. circuit	AC 1,500 V
Insulation resistance	> 100 MΩ (DC 500 V)	
Interrupting capacity I _{cn}	AC 115 V (400 Hz):	1,000 A
		5...25 A
	DC 28 V:	2,000 A
		1...25 A
		6,000 A
Degree of protection (IEC 60529/DIN 40050)	operating area	IP40
	terminal area	IP00
Vibration (sinusoidal)	10 g (57-2000 Hz), ± 0.76 mm (5-57 Hz) to ISO 7137, EN 2350 para. 5.3.1	
Vibration	1...2.5 A: 0.04 g ² /Hz ± 1.5 dB; 7.3 g eff 3...20 A: 0.06 g ² /Hz ± 1.5 dB; 9 g eff to ISO 7137, EN 2350 para. 5.3.1	
Acceleration	17 g, to ISO 2669, EN 2350 para. 5.3.3	
Shock	50 g (11 ms), to ISO 7137, EN 2350 para. 5.3.2	
Corrosion	48 hours at 5 % salt mist to ISO 7137, EN 2350 para. 5.4.2	
Humidity	240 hours at 95 % RH, to ISO 7137, EN 2350 para. 5.4.3	
Explosion	to VG 95210, sheet 10	
Altitude	≤ 22,000 m above sea level	
Mass	approx. 20.6 g with terminal screws, without -Si approx. 24.6 g with terminal screws, with -Si	

Preferred types

Preferred types	Standard current ratings (A)								
	1	2	3	5	7.5	10	15	20	25
4120-G214-J1M1-B2S0ZN (MS3320)	x	x	x	x	x	x	x	x	x
4120-G111-K1M1-A1S0ZN (EN 2495/VG93345 T06)	x	x	x	x	x	x	x	x	x

Mounting holes

4120-G2...

mounting holes S0

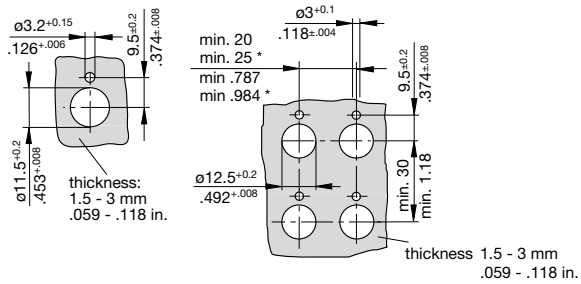

4120-G1...

mounting holes S1 or S5

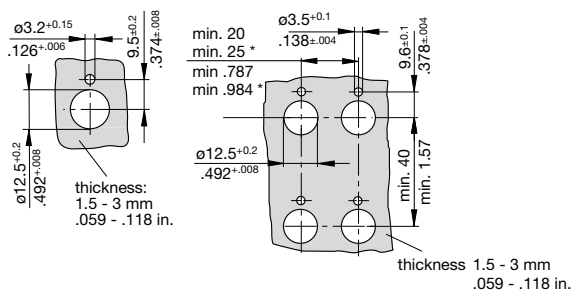

* min. 25 mm / .984 in. when fitted with splash cover

Internal connection diagram

with auxiliary contact VG 95345 T06

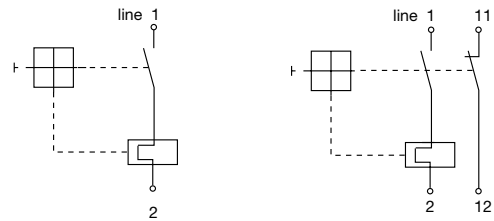

with auxiliary contact EN 2995-004

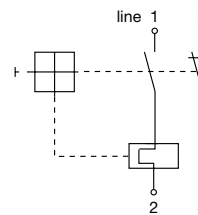

with polarized auxiliary contact EN 2995-005

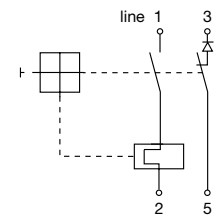

Other terminal designs

Terminal design -J2

Terminal distances to:
MS 14 105 (a, b)
MS 14 153 (a, b)
MS 22 073 (a)
MS 22 074 (a)
MS 25 244 (a)
MS 25 373 (a, b)

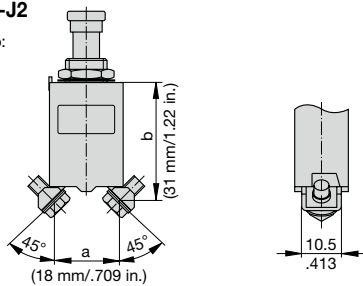

Terminal design -J3

Terminal distances to:
MS 26 574 (a, b)

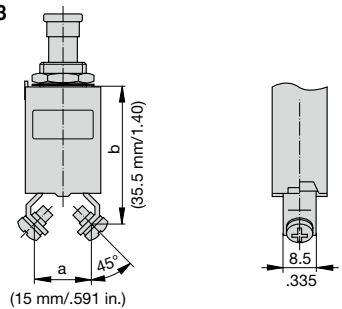

Terminal design -P1

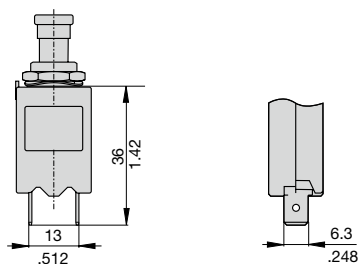

Typical time/current characteristics

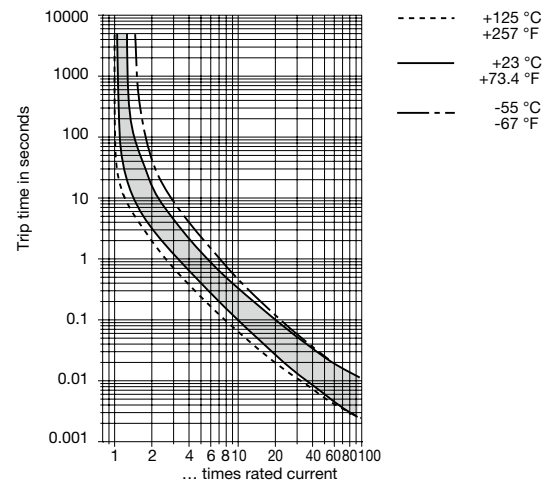

This is a metric design and millimeter dimensions take precedence ($\frac{\text{mm}}{\text{inch}}$)