

Description

Single pole high performance thermal circuit breaker with tease-free, trip-free, snap action mechanism and push/pull on/off manual actuation (M-type TO CBE to EN 60934). An indicator band on the push button clearly shows the tripped/off position. Threadneck panel mounted and available in tracked vehicle, aircraft and general purpose versions.

Typical applications

Extra low voltage wiring systems on all types of vehicles for land, sea and air; defence equipment; battery powered machines.

Ordering information

| | |
|---|---|
| Type No. | |
| 413 | threadneck panel mounting |
| Terminal design | |
| K14 | screw terminals M6 (to aircraft specs.) |
| K54 | reinforced screw terminals M6, housing sealed |
| Version | |
| FN2 | vehicle application, nickel-plated |
| LN2 | aircraft application, black finish |
| N2 | general application, nickel-plated |
| Current ratings | |
| 30...55 A (-FN2) | |
| 30...90 A (-LN2/N2) | |
| 413 - K14 - LN2 - 40 A ordering example | |

Please be informed that we have minimum ordering quantities to be observed.

Preferred types

| Preferred types | Standard current ratings (A) | | | | | | | | |
|-----------------|------------------------------|----|----|----|----|----|----|----|----|
| | 30 | 35 | 40 | 45 | 50 | 60 | 70 | 80 | 90 |
| 413-K54-FN2- | x | x | x | x | x | | | | |
| 413-K14-LN2- | x | x | x | x | x | x | x | x | x |

Standard current ratings and typical voltage drop values

| Current rating (A) | Voltage drop (mV) | | Current rating (A) | Voltage drop (mV) | |
|--------------------|-------------------|-------|--------------------|-------------------|-------|
| | -LN/N | -FN | | -LN/N | -FN |
| 30 | ≤ 250 | ≤ 250 | 55 | - | ≤ 200 |
| 35 | ≤ 250 | ≤ 250 | 60 | ≤ 200 | - |
| 40 | ≤ 200 | ≤ 200 | 70 | ≤ 200 | - |
| 45 | ≤ 200 | ≤ 200 | 80 | ≤ 200 | - |
| 50 | ≤ 200 | ≤ 200 | 90 | ≤ 200 | - |



413-...

Technical data

For further details please see: www.e-t-a.de/ti_e

| | | |
|---|--|-----------------------|
| Voltage rating | DC 28 V AC 115 V (400 Hz) upon request | |
| Current rating range | 30...55 A (-FN2) 30...90 A (-LN2/-N2), | |
| Typical life | 2,000 operations at 1 x I _N | |
| Ambient temperature | -55...+75 °C (-67...+167 °F) | |
| Insulation co-ordination (IEC 60664 and 60664A) | rated impulse withstand voltage 1.5 kV | pollution degree 3 |
| Dielectric strength (IEC 60664 and 60664A) operating area | test voltage AC 1,500 V | |
| Insulation resistance | > 100 MΩ (DC 500 V) | |
| Interrupting capacity I _{cn} | 6,000 A | |
| Interrupting capacity (UL 1077) | 6,000 A | |
| Degree of protection (IEC 60529/DIN 40050) | operating area IP40 terminal area IP00 | |
| Vibration | 10 g (56-500 Hz), ± 0.76 mm (10-55 Hz) to VG 95210, sheet 19, MIL-STD-202, meth. 204, IEC 60068-2-6, test Fc | |
| Shock | 50 g (11 ms) to VG 95210, sheet 28, MIL-STD-202, meth. 213, IEC 60068-2-27, test Ea | |
| Corrosion | 96 hours at 5 % salt mist, to VG 95210, sheet 2, MIL-STD-202, meth. 101, IEC 60068-2-11, test Ka | |
| Humidity | 240 hours at 95 % RH to VG 95210, sheet 7, MIL-STD-202, meth. 106, IEC 60068-2-3, test Ca | |
| Mass | approx. 65 g | |

Dimensions

413-K14-...

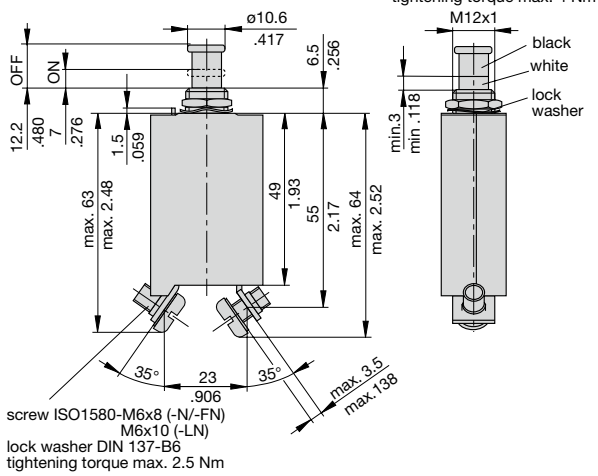

413-K14-LN2

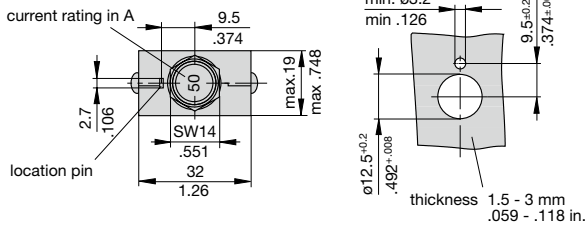

413-K54-...

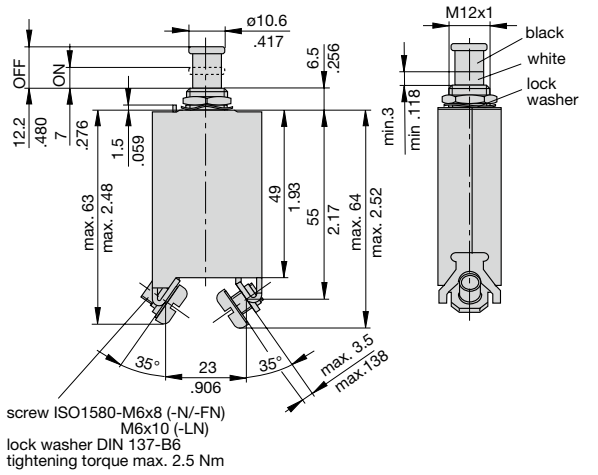

413-K54-FN2/-N2

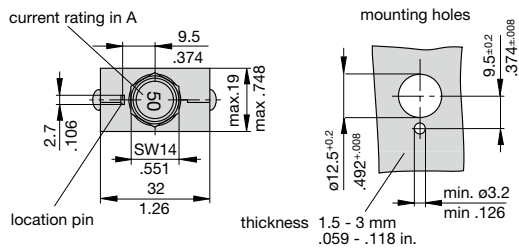

Internal connection diagram

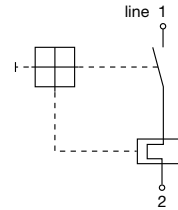

Typical time/current characteristics

413-...-FN2 30...55 A

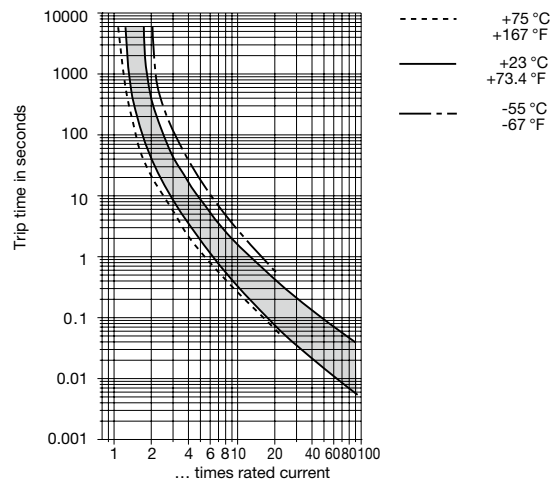

413-...-LN2/-N2 30...90 A

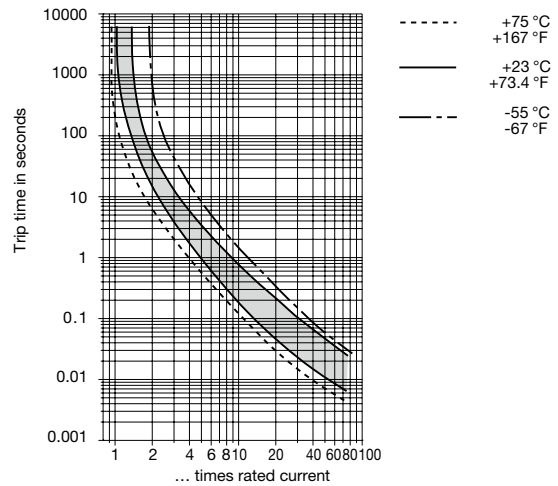

This is a metric design and millimeter dimensions take precedence ($\frac{\text{mm}}{\text{inch}}$)

Accessories (approved to VG 95345, part 23)

Splash cover /hex nut assembly with O ring (IP66 and IP67)
X 200 801 08 nickel plated nut M12x1, transparent cover
X 200 801 03 matt black finish nut M12x1, black cover
X 200 801 12 with blackened nut and transparent cover

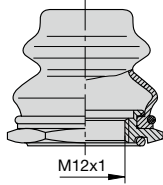

Splash cover black /hex nut assembly with O ring (IP54)
X 200 802 01 nickel plated nut M12x1
X 200 802 02 matt black finish nut M12x1

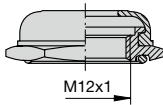

Actuator extension (black)
 to be fitted on the push button
X 200 803 01

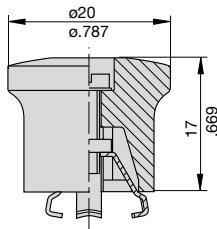

Accessories

Identification collar to be snapped on the push button
Y 307 004 01 black
Y 307 004 02 white
Y 307 004 03 red
Y 307 004 04 green
Y 307 004 05 blue

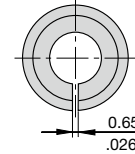
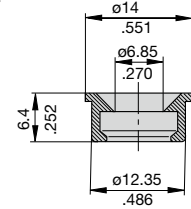

Lock out ring to block the push button in OFF position
Y 307 005 01 red
Y 307 005 02 black

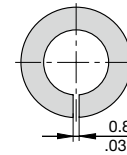
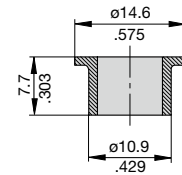

Approvals

| Authority | Standard | Rated voltage | Current ratings |
|---|--------------|---------------|-----------------|
| UL | UL1077 | DC 28 V | 30 A...90 A |
| CSA | C22.2 No 235 | DC 28 V | 30 A...90 A |
| QPL Sweden Defence Material Admin. | TL 5925-001 | DC 28 V | 30 A...50 A |

This is a metric design and millimeter dimensions take precedence ($\frac{\text{mm}}{\text{inch}}$)

All dimensions without tolerances are for reference only. In the interest of improved design, performance and cost effectiveness the right to make changes in these specifications without notice is reserved. Product markings may not be exactly as the ordering codes. Errors and omissions excepted.