



Conforms to IEC947-5-1, IEC947-5-5, EN418, UL508, BS5304
UL and C-UL listed



ER1022

Rope Pull Emergency Stop Switch

- Long rope spans up to 125 m (410 ft.) makes this switch ideal for applications where long rope spans are required
- Heavy-duty housing—the die-cast housing and stainless steel eye nut make the ER1022 suitable for demanding industrial applications
- IP67 (NEMA 6) enclosure enables the ER1022 switch to withstand water washdown cleaning
- Integral E-stop—the E-stop button provides emergency stopping capability at the extreme end of the installation and is field serviceable
- Tension indicator—the tension indicator makes the system easy to set up and to maintain the proper rope tension
- 4 N/C safety contacts and 2 N/O auxiliary contacts satisfy the most demanding applications
- Vibration tolerant—the snap-acting switch contacts protect against nuisance tripping due to vibration
- Long life—the ER1022 switch is designed for a minimum of one million actuations
- Indicator beacon—the indicator beacon can be wired to flash red to indicate a tripped switch or glow a constant green to indicate a properly reset switch

■ Operation



Blue Reset Knob

A blue reset button is provided to easily return the unit back to its machine-run position after actuation.

Installation Hardware Available



RK Rope Tension Kit

The RK Rope Tension Kit comes with all of the required hardware for most installations. A spring is required as shown in the installation example below.

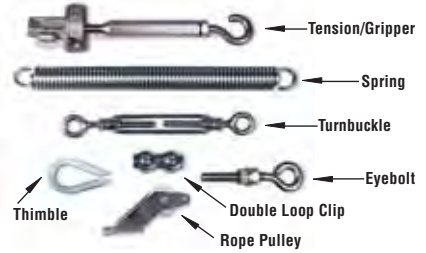

Installation Hardware

Individual hardware items may be purchased for specific installation requirements.

G

safety interlock switches

Contact Arrangements

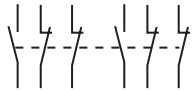

	0 mm 0 in	4.0 0.16	15.0 0.59	17.0 0.67
4NC + 2NO	Rope Slack	Tension Range		Rope Pulled
11/12				
21/22				
33/34				
41/42				
51/52				
63/64				

Contact Open Contact Closed

Mounting Specification

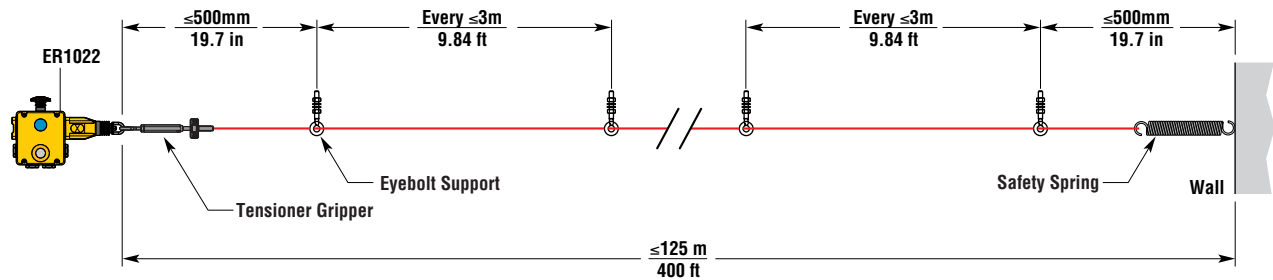
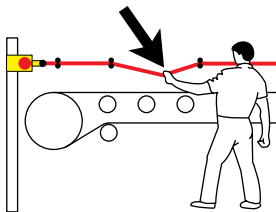

Note: Some installations may require a ER1022 on each end.

For a guide to installing, see "Proper Installation of Rope or Wire Pull Switches" in the Engineering Section of this catalog.



USA Tel. 1/888/510-4357
 Canada Tel. 1/800/221-7060

UK Tel. +44 (0) 1395-273-209
 Europe Tel. +49 (0) 5258-938-776

Japan Tel. +81-466-22-1132
 China Tel. +86-21-5836-7708
 Singapore Tel. +65-648-44-001



For the Latest Information
 On the Internet: www.sti.com
 E-mail: sales@sti.com

■ Applications

Typical applications are on conveyor systems and across rotating machinery, and around hazardous areas.

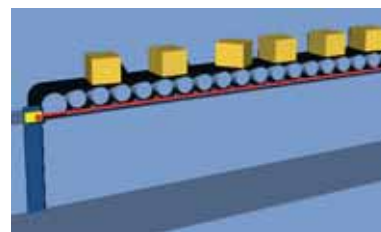
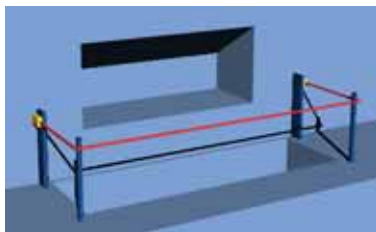

■ Specifications

Electrical	All Models
Contact Configurations:	4 N/C + 2 N/O
Safety Contacts:	4 N/C
Switching Ability	
AC:	240 V–3 A, 120 V–6 A, Inductive
DC:	24 V–2.5 A, Inductive
Auxiliary Contacts:	2 N/O
Max Switching Current/Volt/Amp:	240 V/720 VA
Minimum Current:	5 V 5 mA DC
Electrical Life:	1 x 10 ⁶ minimum
Mechanical	
Mounting:	Any position
Mounting Hardware:	4 x M5 screws
Actuator Travel for Positive Opening:	See diagrams on previous page
Max Rope Span:	125 m (410 ft.)
Operation Force:	< 125 N (28 lb.)
Tensioning Force to Run Position:	130 N (23 lb.) typical
Case Material:	Die-cast aluminum alloy
Eye Nut Material:	Stainless steel
Wiring Entry:	4 x M20 or 3 x 0.5 in. NPT
Weight:	1100 g (39 oz.)
Color:	Yellow
Mechanical Life:	1 x 10 ⁶ minimum
Environmental	
Protection:	IP67 (NEMA 6)
Operating Temperature:	-25 to 80°C (-13 to 176°F)
Cleaning:	Water washdown

Specifications are subject to change without notice.

Note: The safety contacts of the STI switches are described as normally closed (N/C)—i.e., with the rope properly tensioned and the machine able to be started.

■ Dimensions — mm/in.

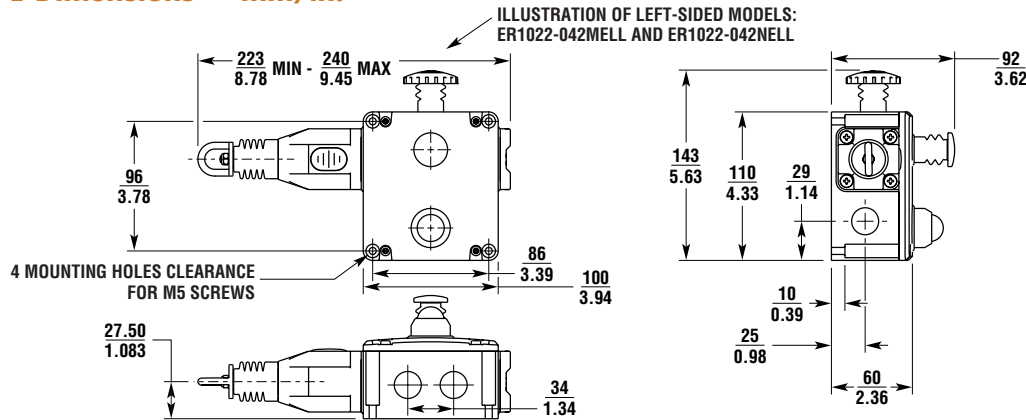

■ Ordering

Model	E-Stop	Indicator Beacon	Contacts	Wiring Entry	Part No.
ER1022-042MELL	Included	Included	4 N/C + 2 N/O	4 x M20	44506-6410
ER1022-042NELL	Included	Included	4 N/C + 2 N/O	4 x 1/2 in. NPT	44506-6420
ER1022-042MELR	Included	Included	4 N/C + 2 N/O	4 x M20	44506-6510
ER1022-042NELR	Included	Included	4 N/C + 2 N/O	4 x 1/2 in. NPT	44506-6520
SM06-SL710, Replacement Lid/LED					44506-6710
RK5, 5 m Rope Kit, Stainless Steel					44506-2705
RK10, 10 m Rope Kit, Stainless Steel					44506-2710
RK15, 15 m Rope Kit, Stainless Steel					44506-2715
RK20, 20 m Rope Kit, Stainless Steel					44506-2720
RK30, 30 m Rope Kit, Stainless Steel					44506-2730
RK50, 50 m Rope Kit, Stainless Steel					44506-2750
RK80, 80 m Rope Kit, Stainless Steel					44506-2780
RK100, 100 m Rope Kit, Stainless Steel					44506-2711
RK126, 126 m Rope Kit, Stainless Steel					44505-2726
R5M, 5 m Rope Only					44506-3705
R10M, 10 m Rope Only					44506-3710
R20M, 20 m Rope Only					44506-3720
R30M, 30 m Rope Only					44506-3730
R50M, 50 m Rope Only					44506-3750
R80M, 80 m Rope Only					44506-3780
R100M, 100 m Rope Only					44506-3711
R126M, 126 m Rope Only					44506-3726
SM06-TG00, Tensioner Gripper, Stainless Steel					44506-4700
SM06-EB10, Eye Bolt Stainless Steel, 8 per pack					44506-4710
SM06-DL20, Double Loop Clip, Stainless Steel, 4 per pack					44506-4720
SM06-DL21, Double Loop Clip, Galvanized, 4 per pack					44506-4721
SM06-THSS, Thimble Stainless Steel, 4 per pack					44506-4770
SM06-THGV, Thimble Galvanized, 4 per pack					44506-4771
SM06-TB30, Turnbuckle, Stainless Steel					44506-4730
SM06-TB31, Turnbuckle, Galvanized					44506-4731
SM06-SP50, Spring, Stainless Steel					44506-4750
SM06-RPSS, Rope Pulley, Stainless Steel					44506-4780
SM06-ES60, E-Stop Mechanism					44506-4760

G

safety interlock switches



Conforms to IEC947-5-1, IEC947-5-5, EN418, UL508, BS5304
UL and C-UL listed



ER1032

Rope Pull Emergency Stop Switch

- Long rope spans up to 200 m (656 ft.) makes this switch ideal for applications where long rope spans are required
- Heavy-duty housing—the die-cast housing and stainless steel eye nut make the ER1032 suitable for demanding industrial applications
- IP67 (NEMA 6) enclosure enables the ER1032 switch to withstand water washdown cleaning
- Integral E-stop—the E-stop button provides emergency stopping capability at the extreme end of the installation and is field serviceable
- Tension indicator—the tension indicator makes the system easy to set up and to maintain the proper rope tension
- 4 N/C safety contacts and 2 N/O auxiliary contacts satisfy the most demanding applications
- Vibration tolerant—the snap-acting switch contacts protect against nuisance tripping due to vibration
- Long life—the ER1032 switch is designed for a minimum of one million actuations
- Indicator beacon—the indicator beacon can be wired to flash red to indicate a tripped switch or glow a constant green to indicate a properly reset switch

G

safety interlock switches

■ Operation



Blue Reset Knob

A blue reset button is provided to easily return the unit back to its machine-run position after actuation.

Installation Hardware Available



RK Rope Tension Kit

The RK Rope Tension Kit comes with all of the required hardware for most installations. A spring is required as shown in the installation example below.

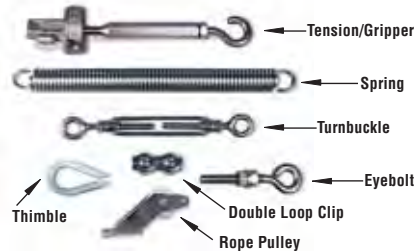

Installation Hardware

Individual hardware items may be purchased for specific installation requirements.

G

safety interlock switches

Contact Arrangements

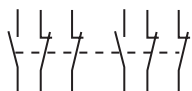

	0 mm 0 in	4.0 0.16	15.0 0.59	17.0 0.67
4NC + 2NO	Rope Slack	Tension Range		Rope Pulled
11/12				
21/22				
33/34				
41/42				
51/52				
63/64				

□ Contact Open ■ Contact Closed

Mounting Specification

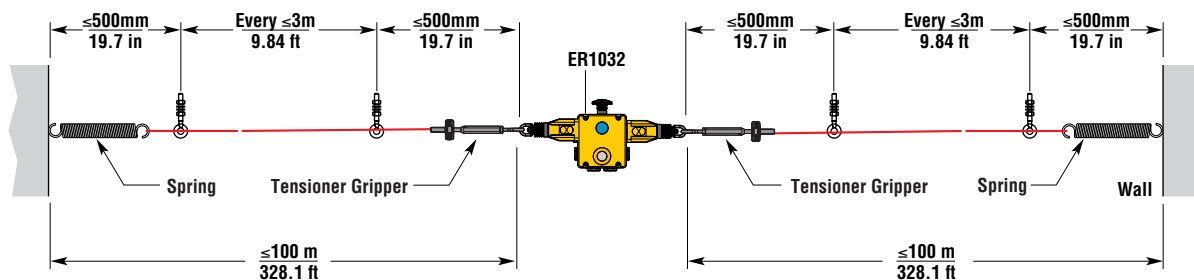
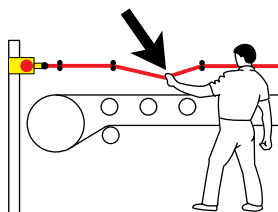

Note: Some installations may require a ER1022 on each end.



For a guide to installing, see "Proper Installation of Rope or Wire Pull Switches" in the Engineering Section of this catalog.



Go to the Engineering Guide
For in-depth information on safety standards and use.



USA Tel. 1/888/510-4357
Canada Tel. 1/800/221-7060

UK Tel. +44 (0) 1395-273-209
Europe Tel. +49 (0) 5258-938-776

Japan Tel. +81-466-22-1132
China Tel. +86-21-5836-7708
Singapore Tel. +65-648-44-001



For the Latest Information
On the Internet: www.sti.com
E-mail: sales@sti.com

■ Applications

Typical applications are on conveyor systems and across rotating machinery, and around hazardous areas.

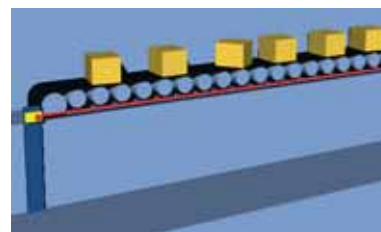
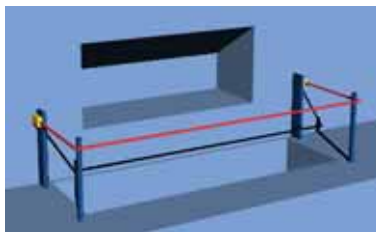

■ Specifications

Electrical	All Models
Contact Configurations:	4 N/C + 2 N/O
Safety Contacts:	4 N/C
Switching Ability	
AC:	240 V–3 A, 120 V–6 A, Inductive
DC:	24 V–2.5 A, Inductive
Auxiliary Contacts:	2 N/O
Max Switching Current/Volt/Amp:	240 V/720 VA
Minimum Current:	5 V 5 mA DC
Electrical Life:	1 x 10 ⁶ minimum
Mechanical	
Mounting:	Any position
Mounting Hardware:	4 x M5 screws
Actuator Travel for Positive Opening:	See diagrams on previous page
Max Rope Span:	125 m (410 ft.)
Operation Force:	< 125 N (28 lb.)
Tensioning Force to Run Position:	130 N (23 lb.) typical
Case Material:	Die-cast aluminum alloy
Eye Nut Material:	Stainless steel
Wiring Entry:	4 x M20 or 4 x 0.5 in. NPT
Weight:	1320 g (42 oz.)
Color:	Yellow
Mechanical Life:	1 x 10 ⁶ minimum
Environmental	
Protection:	IP67 (NEMA 6)
Operating Temperature:	-25 to 80°C (-13 to 176°F)
Cleaning:	Water washdown

Specifications are subject to change without notice.

Note: The safety contacts of the STI switches are described as normally closed (N/C)—i.e., with the rope properly tensioned and the machine able to be started.

■ Dimensions — mm/in.

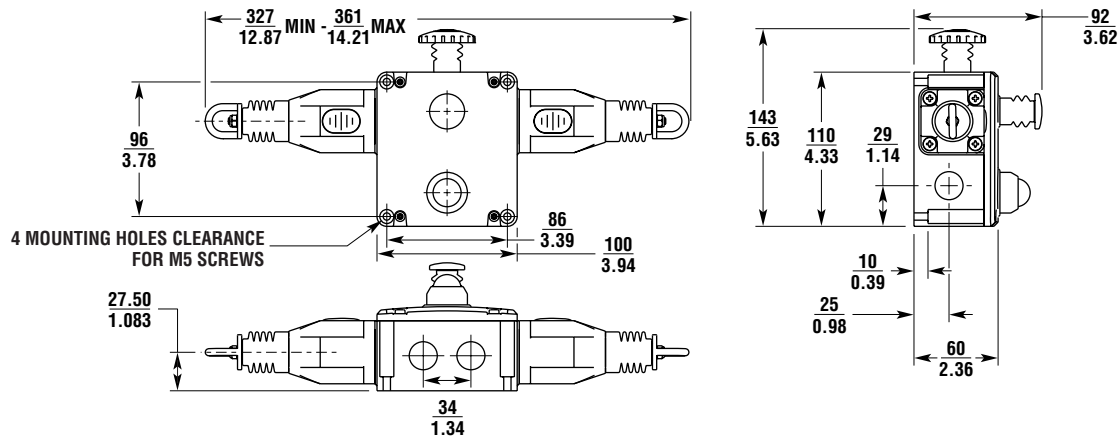

G

safety interlock switches

■ Ordering

Model	E-Stop	Indicator Beacon	Contacts	Wiring Entry	Part No.
ER1032-042MEL	Included	Included	4 N/C + 2 N/O	4 x M20	44506-7410
ER1032-042NEL	Included	Included	4 N/C + 2 N/O	4 x 1/2 in. NPT	44506-7420
SM06-SL711, Replacement Lid/LED					44506-7710
RK5, 5 m Rope Kit, Stainless Steel					44506-2705
RK10, 10 m Rope Kit, Stainless Steel					44506-2710
RK15, 15 m Rope Kit, Stainless Steel					44506-2715
RK20, 20 m Rope Kit, Stainless Steel					44506-2720
RK30, 30 m Rope Kit, Stainless Steel					44506-2730
RK50, 50 m Rope Kit, Stainless Steel					44506-2750
RK80, 80 m Rope Kit, Stainless Steel					44506-2780
RK100, 100 m Rope Kit, Stainless Steel					44506-2711
RK126, 126 m Rope Kit, Stainless Steel					44505-2726
R5M, 5 m Rope Only					44506-3705
R10M, 10 m Rope Only					44506-3710
R20M, 20 m Rope Only					44506-3720
R30M, 30 m Rope Only					44506-3730
R50M, 50 m Rope Only					44506-3750
R80M, 80 m Rope Only					44506-3780
R100M, 100 m Rope Only					44506-3711
R126M, 126 m Rope Only					44506-3726
SM06-TG00, Tensioner Gripper, Stainless Steel					44506-4700
SM06-EB10, Eye Bolt Stainless Steel, 8 per pack					44506-4710
SM06-DL20, Double Loop Clip, Stainless Steel, 4 per pack					44506-4720
SM06-DL21, Double Loop Clip, Galvanized, 4 per pack					44506-4721
SM06-THSS, Thimble Stainless Steel, 4 per pack					44506-4770
SM06-THGV, Thimble Galvanized, 4 per pack					44506-4771
SM06-TB30, Turnbuckle, Stainless Steel					44506-4730
SM06-TB31, Turnbuckle, Galvanized					44506-4731
SM06-SP50, Spring, Stainless Steel					44506-4750
SM06-RPSS, Rope Pulley, Stainless Steel					44506-4780
SM06-ES60, E-Stop Mechanism					44506-4760



Conforms to IEC947-5-1, IEC947-5-5, EN418, UL508, BS5304
UL and C-UL listed



G

safety interlock switches

ER5018

Compact Rope Pull Emergency Stop Switch

- Compact size allows this switch to be used on smaller machines with a mounting width of 40 mm (1.57 in.) and covering rope spans up to 40 m (131 ft.)
- Tension indicator—the tension indicator makes the system easy to set up and to maintain the proper rope tension
- Contact arrangements of 2 N/C + 1 N/O or 3 N/C
- IP67 (NEMA 6) enclosure enables the ER5018 switch to withstand water washdown cleaning
- Heavy-duty housing—the die-cast housing and stainless steel eye nut makes the ER5018 suitable for demanding industrial applications
- Integral E-Stop—the optional E-stop provides emergency stopping at the extreme end of the installation
- Reset button—the blue reset button must be pushed in order to return to “machine run” condition following switch actuation by a pulled or slacked rope
- Long life—the ER5018 switch is designed for a minimum of one million actuations
- Vibration tolerant—the snap-acting switch contacts protect against nuisance tripping due to vibration



For the Latest Information
On the Internet: www.sti.com
E-mail: sales@sti.com

USA Tel. 1/888/510-4357
Canada Tel. 1/800/221-7060

UK Tel. +44 (0) 1395-273-209
Europe Tel. +49 (0) 5258-938-776

Japan Tel. +81-466-22-1132
China Tel. +86-21-5836-7708
Singapore Tel. +65-648-44-001



■ Operation



Blue Reset Knob

A blue reset button is provided to easily return the unit back to its machine-run position after actuation.

Installation Hardware Available



RK Rope Tension Kit

The RK Rope Tension Kit comes with all of the required hardware for most installations. A spring is required as shown in the installation example below.

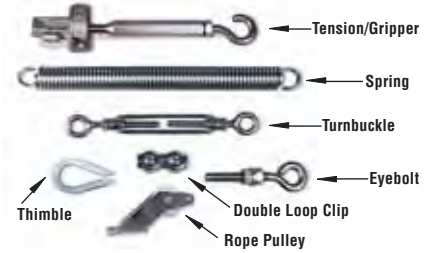

Installation Hardware

Individual hardware items may be purchased for specific installation requirements.

G

safety interlock switches



Emergency Push Button

The emergency push button may be installed or repositioned in the field. The ER5018 has two possible mounting positions for the emergency stop button.

Contact Arrangements

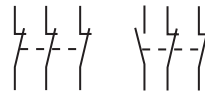

	0 mm 0 in	3.5 0.14	14.5 0.57	17.0 0.67
2NC + 1NO Versions	Rope Slack	Tension Range	Rope Pulled	
11/12				
21/22				
33/34				
3NC Versions	Rope Slack	Tension Range	Rope Pulled	
11/12				
21/22				
31/32				

Contact Open Contact Closed

Mounting Specification

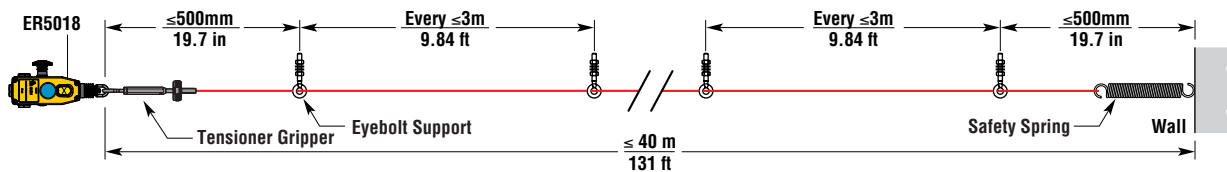
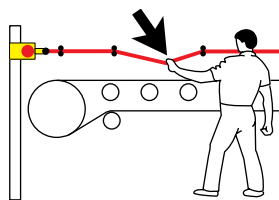

Note: Some installations may require a ER5018 on each end.



For a guide to installing, see "Proper Installation of Rope or Wire Pull Switches" in the Engineering Section of this catalog.

■ Applications

Typical applications are on conveyor systems and across rotating machinery, and around hazardous areas.

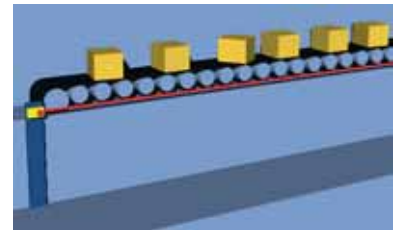
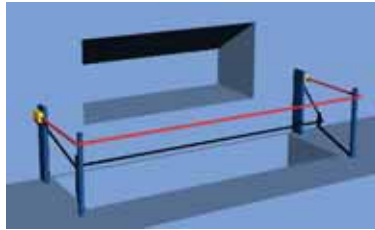

■ Specifications

Electrical	All Models
Contact Configurations:	2 N/C + 1 N/O, 3 N/C
Safety Contacts:	2 N/C, 3 N/C
Switching Ability	
AC:	120 V–6 A, 240 V–3 A, Inductive
DC:	24 V–2.5 A, Inductive
Auxiliary Contacts:	1 N/O
Max Switching Current/Volt/Amp:	240 V/720 VA
Minimum Current:	5 V 5 mA DC
Electrical Life:	1 x 10 ⁶ minimum
Mechanical	
Mounting:	Any position
Mounting Hardware:	2 x M5 screws
Actuator Travel for Positive Opening:	See diagrams on previous page
Max Rope Span:	40 m (131 ft.)
Operation Force:	< 125 N (28 lb.)
Tensioning Force to Run Position:	130 N (23 lb.) typical
Case Material:	Die-cast aluminum alloy
Eye Nut Material:	Stainless steel
Wiring Entry:	3 x M20 or 3 x 0.5 in. NPT
Weight:	675 g (23.8 oz.)
Color:	Yellow
Mechanical Life:	1 x 10 ⁶ minimum
Environmental	
Protection:	IP67 (NEMA 6)
Operating Temperature:	-25 to 80°C (-13 to 176°F)
Cleaning:	Water washdown

Specifications are subject to change without notice.

Note: The safety contacts of the STI switches are described as normally closed (N/C)—i.e., with the rope properly tensioned and the machine able to be started.

■ Dimensions — mm/in.

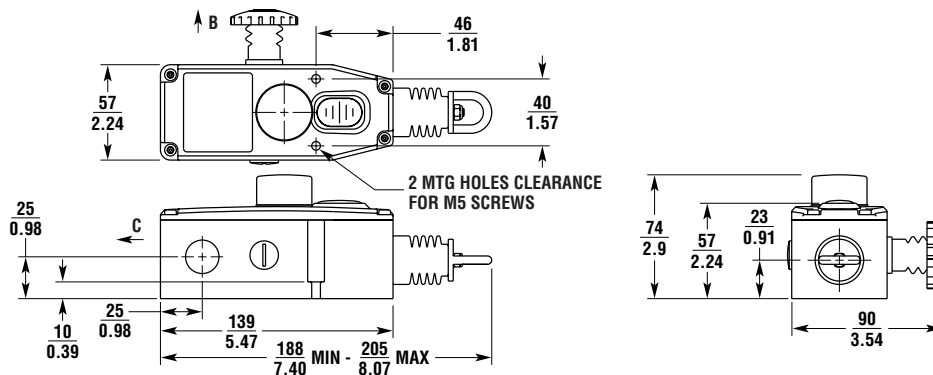

■ Ordering

Model	E-Stop	Contacts	Wiring Entry	Part No.
ER5018-021M	Not included	2 N/C + 1 N/O	3 x M20	44506-4010
ER5018-021N	Not included	2 N/C + 1 N/O	3 x 1/2 in. NPT	44506-4020
ER5018-030M	Not included	3 N/C	3 x M20	44506-4030
ER5018-030N	Not included	3 N/C	3 x 1/2 in. NPT	44506-4040
ER5018-021ME	Included	2 N/C + 1 N/O	3 x M20	44506-4110
ER5018-021NE	Included	2 N/C + 1 N/O	3 x 1/2 in. NPT	44506-4120
ER5018-030ME	Included	3 N/C	3 x M20	44506-4130
ER5018-030NE	Included	3 N/C	3 x 1/2 in. NPT	44506-4140
SM06-SL400, Replacement Lid				44506-3700
RK5, 5 m Rope Kit, Stainless Steel				44506-2705
RK10, 10 m Rope Kit, Stainless Steel				44506-2710
RK15, 15 m Rope Kit, Stainless Steel				44506-2715
RK20, 20 m Rope Kit, Stainless Steel				44506-2720
RK30, 30 m Rope Kit, Stainless Steel				44506-2730
RK50, 50 m Rope Kit, Stainless Steel				44506-2750
R5M, 5 m Rope Only				44506-3705
R10M, 10 m Rope Only				44506-3710
R20M, 20 m Rope Only				44506-3720
R30M, 30 m Rope Only				44506-3730
R50M, 50 m Rope Only				44506-3750
R80M, 80 m Rope Only				44506-3780
R100M, 100 m Rope Only				44506-3711
R126M, 126 m Rope Only				44506-3726
SM06-TG00, Tensioner Gripper, Stainless Steel				44506-4700
SM06-EB10, Eye Bolt Stainless Steel, 8 per pack				44506-4710
SM06-DL20, Double Loop Clip, Stainless Steel, 4 per pack				44506-4720
SM06-DL21, Double Loop Clip, Galvanized, 4 per pack				44506-4721
SM06-THSS, Thimble Stainless Steel, 4 per pack				44506-4770
SM06-THGV, Thimble Galvanized, 4 per pack				44506-4771
SM06-TB30, Turnbuckle, Stainless Steel				44506-4730
SM06-TB31, Turnbuckle, Galvanized				44506-4731
SM06-SP50, Spring, Stainless Steel				44506-4750
SM06-RPSS, Rope Pulley, Stainless Steel				44506-4780
SM06-ES60, E-Stop Mechanism				44506-4760



Conforms to IEC947-5-1, IEC947-5-5, EN418, UL508, BS5304
UL and C-UL listed



G

safety interlock switches

ER6022

Rope Pull Emergency Stop Switch

- Long rope spans up to 80 m (262 ft.) means fewer number of switches required per application
- Tension indicator—the tension indicator makes the system easy to set up and to maintain the proper rope tension
- Contact arrangements of 2 N/C + 1 N/O or 3 N/C
- IP67 (NEMA 6) enclosure enables the ER6022 switch to withstand water washdown cleaning
- Heavy-duty housing—the die-cast housing and stainless steel eye nut makes the ER6022 suitable for demanding industrial applications
- Reset button—the blue reset button must be pushed in order to return to “machine run” condition following switch actuation by a pulled or slacked rope
- Long life—the ER6022 switch is designed for a minimum of one million actuations
- Vibration tolerant—the snap-acting switch contacts protect against nuisance tripping due to vibration
- Indicator beacon—the optional dual indicator beacon, available in 24 VDC, can be wired to flash red to indicate a tripped switch or glow a constant green to indicate a properly reset switch
- E-stop button—the ER6022 has two mounting positions where the optional E-stop button may be installed; the E-stop button may be added or replaced in the field

A **Go to the Engineering Guide**
For in-depth information on safety standards and use.

■ Operation



Blue Reset Knob

A blue reset button is provided to easily return the unit back to its machine-run position after actuation.



Emergency Push Button

The emergency push button may be installed or repositioned in the field. The ER6022 has two possible mounting positions for the emergency stop button.

Installation Hardware Available



RK Rope Tension Kit

The RK Rope Tension Kit comes with all of the required hardware for most installations. A spring is required as shown in the installation example below.

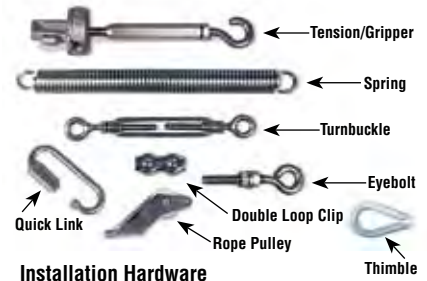

Installation Hardware

Individual hardware items may be purchased for specific installation requirements.

Contact Arrangements

	0 mm 0 in	3.5 0.14	14.5 0.57	17.0 0.67
2NC + 1NO Versions	Rope Slack	Tension Range		Rope Pulled
11/12				
21/22				
33/34				
3NC Versions	Rope Slack	Tension Range		Rope Pulled
11/12				
21/22				
31/32				

Contact Open Contact Closed

Mounting Specification

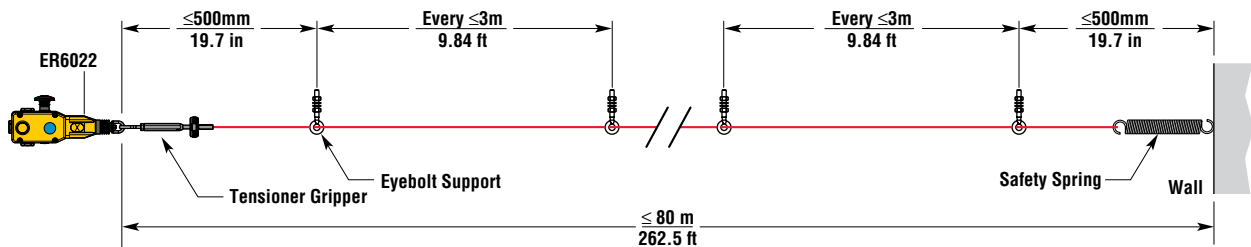
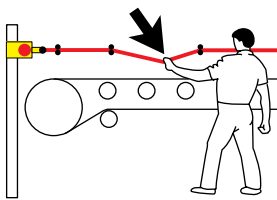

Note: Some installations may require a ER6022 on each end.

For a guide to installing, see "Proper Installation of Rope or Wire Pull Switches" in the Engineering Section of this catalog.

G safety interlock switches



OMRON SCIENTIFIC TECHNOLOGIES, INC.
USA Tel. 1/888/510-4357 Canada Tel. 1/866/986-6766



For the Latest Information
On the Internet: www.sti.com or www.omron.ca



■ Specifications

Electrical	All Models
Contact Configurations:	2 N/C + 1 N/O, 3 N/C
Safety Contacts:	2 N/C, 3 N/C
Switching Ability	AC: 240 V–3 A, 120 V–6 A, Inductive, DC: 24 V–2.5 A, Inductive
Auxiliary Contacts:	1 N/O
Max Switching Current/Volt/Amp:	240 V/720 VA
Minimum Current:	5 V 5 mA DC
Electrical Life:	1 x 10 ⁶ minimum
LED Indicator Beacon:	24 VDC
Mechanical	
Mounting:	Any position
Mounting Hardware:	4 x M5 screws
Actuator Travel for Positive Opening:	See diagrams on previous page
Max Rope Span:	80 m (262 ft.)
Operation Force:	< 125 N (28 lb.)
Tensioning Force to Run Position:	130 N (23 lb.) typical
Case Material:	Die-cast aluminum alloy
Eye Nut Material:	Stainless steel
Wiring Entry:	3 x M20 or 3 x 0.5 in. NPT
Weight:	880 g (31 oz.)
Color:	Yellow
Mechanical Life:	1 x 10 ⁶ minimum
Environmental	
Protection:	IP67 (NEMA 6)
Operating Temperature:	-25 to 80°C (-13 to 176°F)
Cleaning:	Water washdown
Compliance	
Standards:	IEC947-5-1, IEC947-5-5, EN418, UL508, BS5304
Approvals/Listings:	CE marked for all applicable directives, UL and C-UL

Specifications are subject to change without notice.

Note: The safety contacts of the Omron STI switches are described as normally closed (N/C)—i.e., with the rope properly tensioned and the machine able to be started.

■ Dimensions — mm/in.

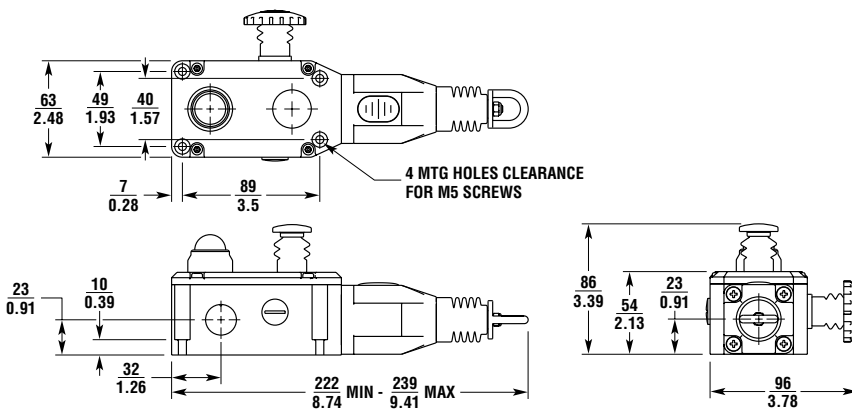

■ Applications

Typical applications are on conveyor systems and across rotating machinery, and around hazardous areas.

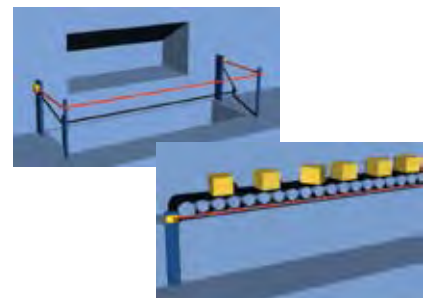

■ Ordering

Model	E-Stop	Indicator Beacon	Contacts	Wiring Entry	Part No.
ER6022-021M	Not included	Not included	2 N/C + 1 N/O	3 x M20	44506-5010
ER6022-021N	Not included	Not included	2 N/C + 1 N/O	3 x 1/2 in. NPT	44506-5020
ER6022-030M	Not included	Not included	3 N/C	3 x M20	44506-5030
ER6022-030N	Not included	Not included	3 N/C	3 x 1/2 in. NPT	44506-5040
ER6022-021ML	Not included	Included (24 VDC)	2 N/C + 1 N/O	3 x M20	44506-5110
ER6022-021NL	Not included	Included (24 VDC)	2 N/C + 1 N/O	3 x 1/2 in. NPT	44506-5120
ER6022-030ML	Not included	Included (24 VDC)	3 N/C	3 x M20	44506-5130
ER6022-030NL	Not included	Included (24 VDC)	3 N/C	3 x 1/2 in. NPT	44506-5140
ER6022-021ME	Included	Not included	2 N/C + 1 N/O	3 x M20	44506-5210
ER6022-021NE	Included	Not included	2 N/C + 1 N/O	3 x 1/2 in. NPT	44506-5220
ER6022-030ME	Included	Not included	3 N/C	3 x M20	44506-5230
ER6022-030NE	Included	Not included	3 N/C	3 x 1/2 in. NPT	44506-5240
ER6022-021MEL	Included	Included (24 VDC)	2 N/C + 1 N/O	3 x M20	44506-5410
ER6022-021NEL	Included	Included (24 VDC)	2 N/C + 1 N/O	3 x 1/2 in. NPT	44506-5420
ER6022-030MEL	Included	Included (24 VDC)	3 N/C	3 x M20	44506-5430
ER6022-030NEL	Included	Included (24 VDC)	3 N/C	3 x 1/2 in. NPT	44506-5440

	Part No.
SM06-SL500, Replacement Lid 24 VDC	44506-5700
SM06-SL510, Replacement Lid/LED	44506-5710
SM06-SL510AC, Replacement Lid/LED 120 VAC (consult factory for complete switch with 120 VAC beacon)	44506-5711
RK5, 5 m Rope Kit, Stainless Steel	44506-2705
RK10, 10 m Rope Kit, Stainless Steel	44506-2710
RK15, 15 m Rope Kit, Stainless Steel	44506-2715
RK20, 20 m Rope Kit, Stainless Steel	44506-2720
RK30, 30 m Rope Kit, Stainless Steel	44506-2730
RK50, 50 m Rope Kit, Stainless Steel	44506-2750
RK80, 80 m Rope Kit, Stainless Steel	44506-2780
R5M, 5 m Rope Only	44506-3705
R10M, 10 m Rope Only	44506-3710
R20M, 20 m Rope Only	44506-3720
R30M, 30 m Rope Only	44506-3730
R50M, 50 m Rope Only	44506-3750
R80M, 80 m Rope Only	44506-3780
R100M, 100 m Rope Only	44506-3711
R126M, 126 m Rope Only	44506-3726

	Part No.
SM06-TG00, Tensioner Gripper, Stainless Steel	44506-4700
SM06-EB10, Eye Bolt Stainless Steel, 8 per pack	44506-4710
SM06-DL20, Double Loop Clip, Stainless Steel, 4 per pack	44506-4720
SM06-DL21, Double Loop Clip, Galvanized, 4 per pack	44506-4721
SM06-THSS, Thimble Stainless Steel, 4 per pack	44506-4770
SM06-THGV, Thimble Galvanized, 4 per pack	44506-4771
SM06-QLSS, Quick Link Stainless Steel	44506-4772
SM06-TB30, Turnbuckle, Stainless Steel	44506-4730
SM06-TB31, Turnbuckle, Galvanized	44506-4731
SM06-SP50, Spring, Stainless Steel	44506-4750
SM06-RPSS, Rope Pulley, Stainless Steel	44506-4780
SM06-ES60, E-Stop Mechanism	44506-4760
SM06-LF40, Replacement LED Indicator Beacon, 24 VDC	44506-4740
SM06-LF41, Replacement LED Indicator Beacon, 120 VAC	44506-4741

G

safety interlock switches



Conforms to IEC947-5-1, IEC947-5-5, EN418, UL508, BS5304



G

safety interlock switches

ER6022-SS and XER6022-SS

Stainless Steel Rope Pull Emergency Stop Switch

- Long rope spans up to 100 m (328 ft.) means fewer number of switches required per application
- Tension indicator—the tension indicator makes the system easy to set up and to maintain the proper rope tension
- Contact arrangements of 3 N/C + 1 N/O or 2 N/C + 2 N/O available for ER6022-SS models; Contact arrangement of 1 N/C + 1 N/O or 2 N/C available for XER6022-SS models
- IP67 (NEMA 6) enclosure enables these switches to withstand water washdown cleaning
- Heavy-duty housing—the 316 stainless steel cast housing and stainless steel hardware make the ER6022-SS and XER6022-SS suitable for demanding industrial applications
- Reset button—the blue reset button must be pushed in order to return to “machine run” condition following switch actuation by a pulled or slacked rope
- Long life—the ER6022-SS and XER6022-SS switches are designed for a minimum of one million actuations
- Vibration tolerant—the snap-acting switch contacts protect against nuisance tripping due to vibration
- Indicator beacon—the dual indicator beacon is optional on the ER6022-SS; the indicator beacon can be wired to flash red to indicate a tripped switch or glow a constant green to indicate a properly reset switch
- E-stop button—the ER6022-SS and XER6022-SS have two mounting positions where the optional E-stop button may be installed; the E-stop button may be added or replaced in the field



Operation



Blue Reset Knob

A blue reset button is provided to easily return the unit back to its machine-run position after actuation.



Emergency Push Button

The emergency push button may be installed or repositioned in the field. The ER6022-SS and XER6022-SS have two possible mounting positions for the emergency stop button. To assure compliance with all applicable European and Canadian standards, the supplied yellow background label must be applied.

Mounting Specification

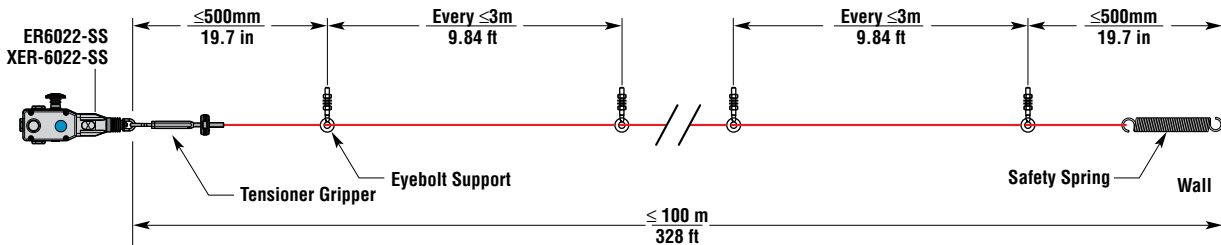
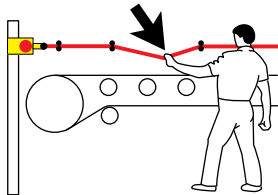

Note: Some installations may require a ER6022-SS/XER6022-SS on each end.

For a guide to installing, see "Proper Installation of Rope or Wire Pull Switches" in the Engineering Section of this catalog.

Installation Hardware Available



RK Rope Tension Kit

The RK Rope Tension Kit comes with all of the required hardware for most installations. A spring is required as shown in the installation example below.

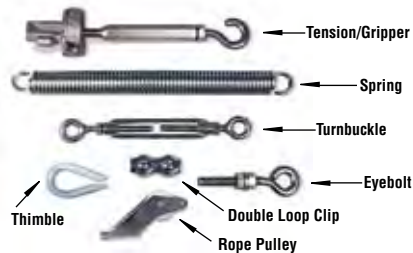

Installation Hardware

Individual hardware items may be purchased for specific installation requirements.

Contact Arrangements



ER6022-SS	0 mm 0 in	3.5 0.14	14.5 0.57	17.0 0.67
3NC + 1NO Versions	Rope Slack	Tension Range		Rope Pulled
11/12				
21/22				
33/34				
43/44				
2NC + 2NO Versions	Rope Slack	Tension Range		Rope Pulled
11/12				
21/22				
33/34				
43/44				
XER6022-SS	0 mm 0 in	3.5 0.14	14.5 0.57	17.0 0.67
2NC Versions	Rope Slack	Tension Range		Rope Pulled
Brown/Blue				
Black/Black				
1NC + 1 NO Versions	Rope Slack	Tension Range		Rope Pulled
Brown/Blue				
Black/Black				

Contact Open Contact Closed

■ Specifications

Electrical	ER6022-SS	XER6022-SS
Ex Classification:		II 2 G EEx d II C T6
Certification:		PTB 00 ATEX 1093X IBExU 01 ATEX 1007X
Contact Configurations:	3 N/C + 1 N/O, 2 N/C + 2 N/O	1 N/C + 1 N/O, 2 N/C
Safety Contacts:	2 N/C, 3 N/C	1 N/C, 2 N/C
Switching Ability	AC: 240 V—3 A, 120 V—6 A, Inductive DC: 24 V—2.5 A, Inductive	250 V—3 A, 125 V—3A, Inductive 30 V—5 A, Inductive
Auxiliary Contacts:	1 N/O, 2 N/O	1 N/O
Max Switching Current/Volt/Amp:	240 V/720 VA	240 V/720 VA
Minimum Current:	5 V 5 mA DC	5 V 5 mA DC
Electrical Life:	1 x 10 ⁶ minimum	1 x 10 ⁶ minimum
LED Indicator Beacon:	24 VDC	N/A
Mechanical		
Mounting:	Any position	Any position
Mounting Hardware:	4 x M5 screws	4 x M5 screws
Actuator Travel for Positive Opening:	See diagrams on previous page	See diagrams on previous page
Max Rope Span:	100 m (328 ft.)	100 m (328 ft.)
Operation Force:	< 125 N (28 lb.)	< 125 N (28 lb.)
Tensioning Force to Run Position:	130 N (23 lb.) typical	130 N (23 lb.) typical
Case Material:	Die-cast aluminum alloy	316 stainless steel casting
Eye Nut Material:	Stainless steel	Stainless steel
Wiring Entry:	3 x M20 or 3 x 0.5 in. NPT	3 m cable
Weight:	880 g (31 oz.)	1750 g (62 oz.)
Color:	Natural	Natural
Mechanical Life:	1 x 10 ⁶ minimum	1 x 10 ⁶ minimum
Environmental		
Protection:	IP67 (NEMA 6)	IP67 (NEMA 6)
Operating Temperature:	-25 to 80°C (-13 to 176°F)	-25 to 80°C (-13 to 176°F)
Cleaning:	Water washdown	Water washdown
Compliance		
Standards:	IEC947-5-1, IEC947-5-5, EN418, UL508, BS5304	
Approvals/Listings:	CE marked for all applicable directives (UL and C-UL pending, TUV pending)	

Specifications are subject to change without notice. Note: The safety contacts of the Omron STI switches are described as normally closed (N/C)—i.e., with the rope properly tensioned and the machine able to be started.

■ Dimensions — mm/in.

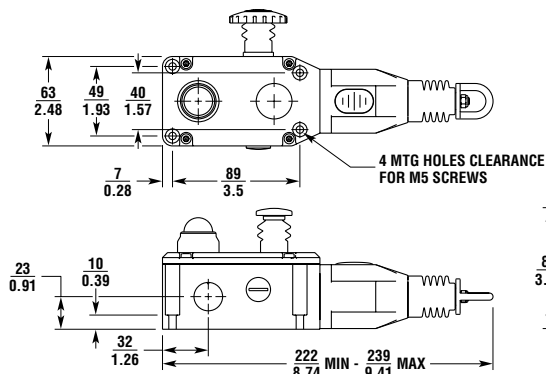

■ Applications

Typical applications are on conveyor systems and across rotating machinery, and around hazardous areas.

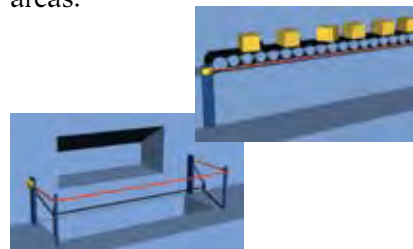

■ Ordering

Model	E-Stop	Indicator Beacon	Contacts	Wiring Entry	Part No.
ER6022-SS					
ER6022-022MSS	Not included	Not included	2 N/C + 2 N/O	3 x M20	44506-5810
ER6022-022NSS	Not included	Not included	2 N/C + 2 N/O	3 x 1/2 in. NPT	44506-5820
ER6022-031MSS	Not included	Not included	3 N/C + 1 N/O	3 x M20	44506-5830
ER6022-031NSS	Not included	Not included	3 N/C + 1 N/O	3 x 1/2 in. NPT	44506-5840
ER6022-022MESS	Included	Not included	2 N/C + 2 N/O	3 x M20	44506-5850
ER6022-022NESS	Included	Not included	2 N/C + 2 N/O	3 x 1/2 in. NPT	44506-5860
ER6022-031MESS	Included	Not included	3 N/C + 1 N/O	3 x M20	44506-5870
ER6022-031NESS	Included	Not included	3 N/C + 1 N/O	3 x 1/2 in. NPT	44506-5880
ER6022-022MLSS	Not included	Included (24 VDC)	2 N/C + 2 N/O	3 x M20	44506-5910
ER6022-022NLSS	Not included	Included (24 VDC)	2 N/C + 2 N/O	3 x 1/2 in. NPT	44506-5920
ER6022-031MLSS	Not included	Included (24 VDC)	3 N/C + 1 N/O	3 x M20	44506-5930
ER6022-031NLSS	Not included	Included (24 VDC)	3 N/C + 1 N/O	3 x 1/2 in. NPT	44506-5940
ER6022-022MELSS	Included	Included (24 VDC)	2 N/C + 1 N/O	3 x M20	44506-5950
ER6022-022NELSS	Included	Included (24 VDC)	2 N/C + 1 N/O	3 x 1/2 in. NPT	44506-5960
ER6022-031MELSS	Included	Included (24 VDC)	3 N/C + 1 N/O	3 x M20	44506-5970
ER6022-031NELSS	Included	Included (24 VDC)	3 N/C + 1 N/O	3 x 1/2 in. NPT	44506-5980
XER6022-SS					
ER6022-011C3SS	Not included	N/A	1 N/C + 1 N/O	3 m cable	44506-5610
ER6022-020C3SS	Not included	N/A	2 N/C	3 m cable	44506-5620

	Part No.
SM06-SLXER6022SS, Replacement Lid for ER6022-SS and XER6022-SS without LED	44506-5730
SM06-SLER6022LSS, Replacement Lid for ER6022-SS with LED 24 VDC	44506-5740
SM06-SLER6022LSSAC, Replacement Lid for ER6022-SS with LED 120 VAC (consult factory for complete switch with 120 VAC beacon)	44506-5741
RK5, 5 m Rope Kit, Stainless Steel	44506-2705
RK10, 10 m Rope Kit, Stainless Steel	44506-2710
RK15, 15 m Rope Kit, Stainless Steel	44506-2715
RK20, 20 m Rope Kit, Stainless Steel	44506-2720
RK30, 30 m Rope Kit, Stainless Steel	44506-2730
RK50, 50 m Rope Kit, Stainless Steel	44506-2750
RK80, 80 m Rope Kit, Stainless Steel	44506-2780
R5M, 5 m Rope Only	44506-3705
R10M, 10 m Rope Only	44506-3710
R20M, 20 m Rope Only	44506-3720
R30M, 30 m Rope Only	44506-3730
R50M, 50 m Rope Only	44506-3750
R80M, 80 m Rope Only	44506-3780
R100M, 100 m Rope Only	44506-3711
R126M, 126 m Rope Only	44506-3726

	Part No.
SM06-TG00, Tensioner Gripper, Stainless Steel	44506-4700
SM06-EB10, Eye Bolt Stainless Steel, 8 per pack	44506-4710
SM06-DL20, Double Loop Clip, Stainless Steel, 4 per pack	44506-4720
SM06-DL21, Double Loop Clip, Galvanized, 4 per pack	44506-4721
SM06-THSS, Thimble Stainless Steel, 4 per pack	44506-4770
SM06-THGV, Thimble Galvanized, 4 per pack	44506-4771
SM06-TB30, Turnbuckle, Stainless Steel	44506-4730
SM06-TB31, Turnbuckle, Galvanized	44506-4731
SM06-SP50, Spring, Stainless Steel	44506-4750
SM06-RPSS, Rope Pulley, Stainless Steel	44506-4780
SM06-ES60, E-Stop Mechanism	44506-4760
SM06-LF40, Replacement LED Indicator Beacon, 24 VDC	44506-4740
SM06-LF41, Replacement LED Indicator Beacon, 120 VAC	44506-4741

G

safety interlock switches

ER-Series

Operating Instructions for ER5018, ER6022, ER1022 & ER1032

Installation must be in accordance with the following steps and stated specifications and should be carried out by suitably competent personnel. Adherence to the recommended maintenance instructions forms part of the warranty.

⚠ WARNING: Do not defeat, tamper, remove or bypass this unit. Severe injury to personnel could result.

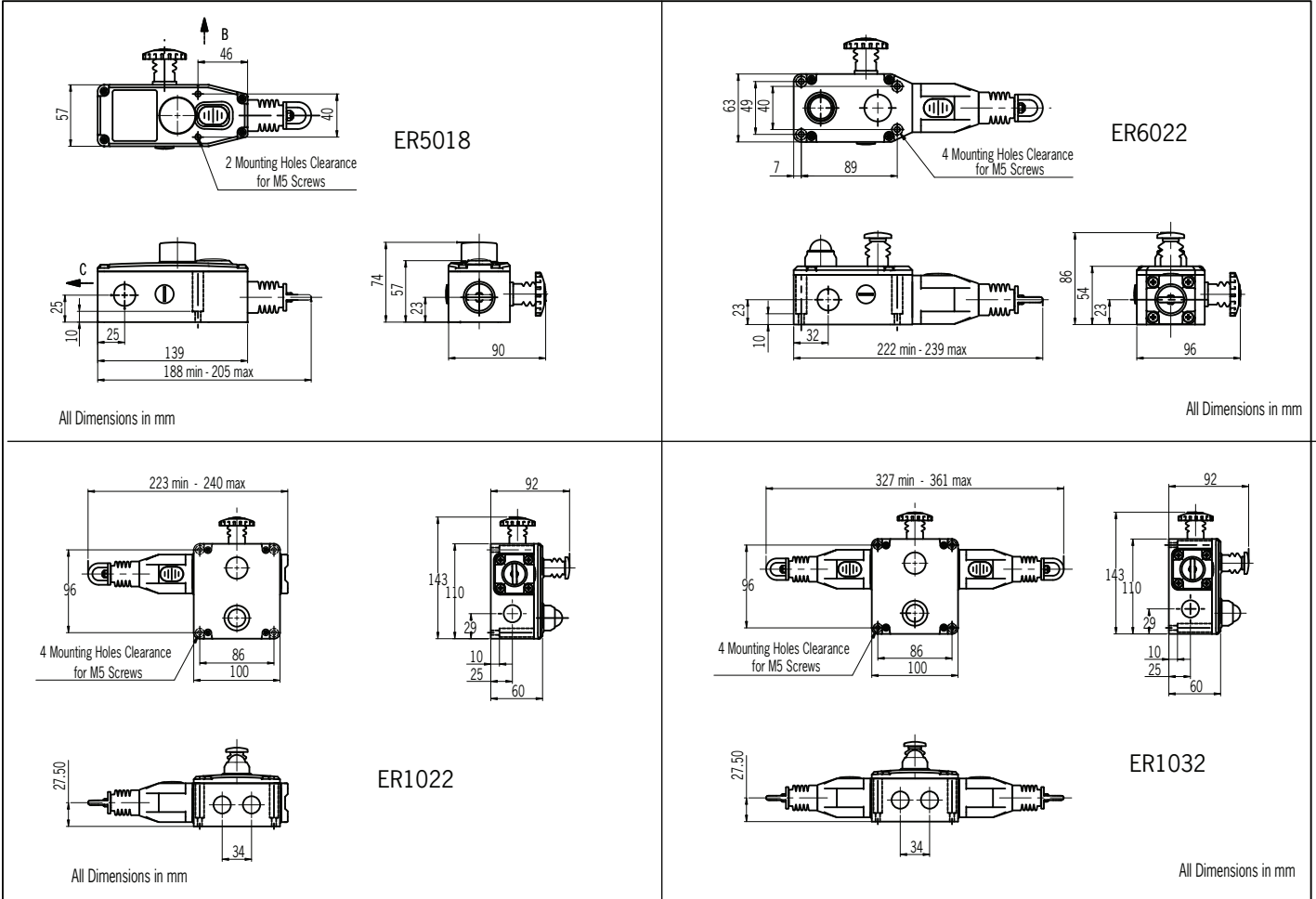

ER5018

0mm	3.5mm	14.5mm	17.0mm
2NC 1NO versions	Rope Slack	Tension Range	Rope Pulled
11/12			
21/22			
33/34			

3NC versions	Rope Slack	Tension Range	Rope Pulled
11/12			
21/22			
31/32			

ER6022

0mm	4.0mm	14.5mm	17.0mm
2NC 1NO versions	Rope Slack	Tension Range	Rope Pulled
11/12			
21/22			
33/34			

3NC versions	Rope Slack	Tension Range	Rope Pulled
11/12			
21/22			
31/32			

ER1022 & ER1032

0mm	4.0mm	15.0mm	17.0mm
4NC 2NO	Rope Slack	Tension Range	Rope Pulled
11/12 41/42			
21/22 51/52			
32/34 63/64			

Contact open
Contact closed

ER5018

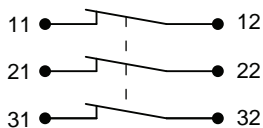
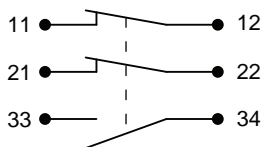

ER6022

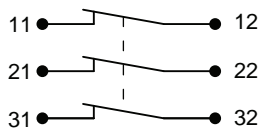
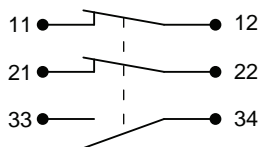

ER1022 & ER1032

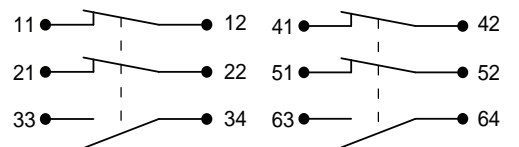

ER Series

Operating Instructions for ER5018, ER6022, ER1022 & ER1032

Optional Indicator Beacon

When +24VDC is applied to the **red** wire, the beacon will illuminate red and flash.

When +24 VDC is applied to the **green** wire, the beacon will illuminate green.

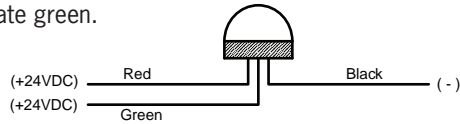

Tension Indicator

Indicator shown with steel rope properly adjusted.

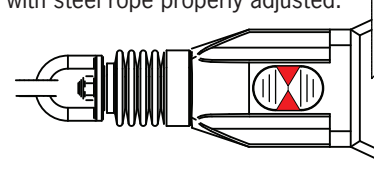

1. Installation of all Safety Rope Switch systems must be in accordance with a risk assessment for the individual application. Installation must only be carried out by competent personnel and in accordance with these instructions.

2. Rope support eyebolts must be fitted at 2.5m. min. to 3m. max. intervals along all rope lengths between switches. The rope must be supported no more than 500mm from the switch eyebolt or Safety Spring (if used). It is important that this first 500mm is not used as part of the active protection coverage.

3. M5 mounting bolts must be used to fix the switches. Tightening torque for mounting bolts to ensure reliable fixing is 4Nm. Tightening torque for the lid screws, conduit entry plugs and cable glands must be 1.5Nm to ensure IP seal. Only use correct sizing glands for conduit entry and cable outside diameter.

4. Tensioning of rope is achieved by use of tensioner / gripper assemblies. Upon installation, tension to mid-position as indicated by the red arrows in the viewing window of each switch. Check operation for all switches and the control circuits by pulling the rope at various locations along the active protection area and resetting each switch by depressing the Blue Reset button. Ensure each time that the switches latch off and require manual resetting by depressing the Blue Reset button. Increase the system tension further, if required, depending upon the checks along the active length of coverage. If fitted with a Mushroom type E-Stop button (Red) then test and reset each switch to ensure function of control circuits. Typical operational conditions for successful operation of system is less than 75N. pulling force and less than 150mm deflection of rope between eyebolt supports. If the optional LED is fitted but is not used, ensure that the conductors remain coiled and tied to the tie hole in the LED flange.

5. Every week: Check correct operation of system at locations along all coverage length. Check for nominal tension setting, re-tension rope if necessary. Every 6 months: Isolate power and remove cover. Check screw terminal tightness and check for signs of moisture ingress. Never attempt to repair any switch.

Standards IEC 947-5-1, IEC947-5-5, EN 418, UL508, BS 5304

Approvals cULus, TUV, some pending

Mechanical Features

Enclosure / Cover	Die-Cast – Painted Yellow
External Parts	Steel
IP Rating	IP67
Rope Spans Max	ER1022, ER1032 (Heavy Duty), Dual Head 200m., Single Head 125m. ER6022 (Standard Duty) = 80m. ER5018 (Mini Duty) = 40m.
Mounting	4 x M5 or 2 x M5 (ER5018)
Mounting position	Any
Conduit entries	ER1022, ER1032 (Heavy Duty) = 4 x M20 or 4 x ½" NPT ER6022 (Standard Duty) = 3 x M20 or 3 x ½" NPT ER5018 (Mini Duty) = 3 x M20 or 3 x ½" NPT
Torque settings	Mounting = M5 4.0 Nm Lid = Torx M4 1.5 Nm Terminals = 1.0 Nm
Ambient Operating Temperature	-25C. to 80 C.
Vibration resistance	10-500Hz 0.35mm
Shock resistance	15g 11ms
Tension Force (typical mid setting)	ER1022, ER1032 (Heavy Duty) 130N. ER6022 (Standard Duty) 130N. ER5018 (Mini Duty) 100N.
Typical Operating Force (Rope pulled)	< 125N. < 300mm Deflection
Mechanical Life	1,000,000 operations
Weight	ER1022, ER1032 (Heavy Duty) Dual 1320 g. Single 1100 g. ER6022 (Standard Duty) 880 g. ER5018 (Mini Duty) 675 g.

Electrical

Contact type	IEC 947-5-1 Double break Type Zb Snap Action up to 4NC (Safety positive break) 2NO (Auxiliary)
Contact Material	Silver
Termination	Clamp up to 2.5 sq. mm conductors
Switching Ability	AC = 240V 3A, 120V 6A, Inductive DC = 24V 2.5A, Inductive
Max Switching Current / Volt / Amp	240V / 720 VA Break
Information with regard to UL 508	Use polymeric conduit only. Use copper conductors only. Electrical rating: A300. Type 1 enclosures



Headquarters

Scientific Technologies Inc.

6550 Dumbarton Circle, Fremont CA 94555-3605 USA

Tel: 1/510/608-3400 (Int. +510/608-3400)

Fax: 1/510/744-1442

24 hour fax back system: 1/916/431-6544

E-mail: sales@sti.com

www.sti.com

European Tech Support

Tel: +49 (0) 52 58 93 87 76

Fax: +49 (0) 52 58 93 56 90

UK Sales Office

Tel: +44 (0) 1395-273-209

Fax: +44 (0) 1395-276-183

RK-Series Rope Tension Kits and Accessories

Operating Instructions for Rope Tension Kits and Accessories

RK-Series Rope Kit Hardware Contents

PN 44506-4710
Eye Bolt SS

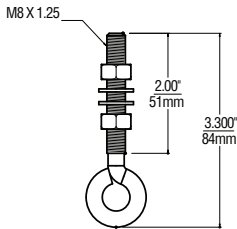

Quick Link
(only available with the
RK-Series Rope Kit)

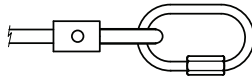

4mm Allen Wrench
(only available with
RK-Series Rope Kit)

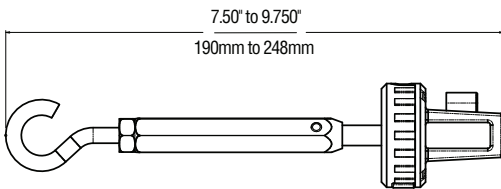

Tensioner Gripper SS
PN 44506-4700

Note: The quantity of Eye Bolts and Tension Grippers depends on the length of the RK-Rope Kit purchased.

Available Optional Hardware (can be ordered individually)

Thimble
Galv: PN 44506-4771
SS: PN 44506-4770

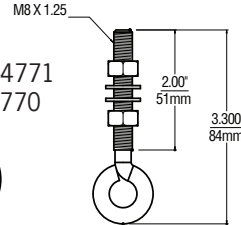

Double Loop Clip
Galv: PN 44506-4721
SS: PN 44506-4720



Turnbuckle
Galv: PN44506-4731
SS: PN 44506-4730

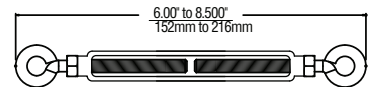

Spring SS
PN 44506-4750

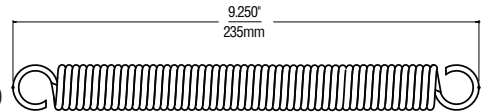

Rope Pulley SS
PN 44506-4780

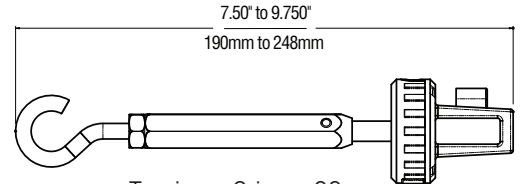
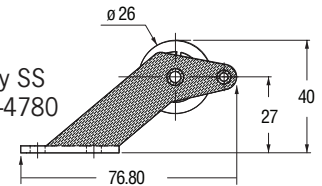

Tensioner Gripper SS
PN 44506-4700

The Double Loop Clip is used to connect to tensioning hardware or to terminate rope span.

Follow steps 1 through 5 in the illustration below to attach the wire rope to the Tensioner Gripper Assembly.

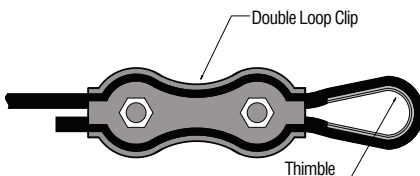

- Step 1: wire rope enters Tensioner/Gripper hole 1.
- Step 2: pass wire rope through hole 2.
- Step 3: bring wire rope back through hole 3.
- Step 4: loop wire rope and terminate into hole 4.
- Step 5: Tighten Allen head screw with M4 allen key.

