

## Description

Single pole high performance thermal-magnetic circuit breaker, with tease-free, trip-free, snap action mechanism and push/pull on/off actuation (M-type TM CBE to EN 60934). An indicator band on the push button clearly shows the tripped/off position. Threadneck panel mounted in tracked vehicle and aircraft/general purpose versions.

## Typical applications

Extra low voltage wiring systems on all types of vehicle for land, sea and air; defence equipment; battery powered machines.

## Ordering information

### Type No.

452 standard delay curve

### Terminal design

K34 screw terminals M6, reinforced

### Version

FN2 vehicle application

LN2 aircraft/general application

### Current ratings

50...100 A

452 - K34 - LN2 - 80 A ordering example

Please be informed that we have minimum ordering quantities to be observed.

## Standard current ratings and typical volt drop values

Current rating (A)	Volt drop (mV)*	Current rating (A)	Volt drop (mV)*
50	90	80	92
60	85	90	100
70	85	100	100
75	90		

\* Max. values are within the relevant standards.

## Approvals (without auxiliary contacts)

Authority	Standard	Rated voltage	Current ratings
UL	UL 1077	DC 28 V DC 72 V	50 A...125 A 50 A...125 A
CSA	C22.2 No 235	DC 28 V DC 72 V	50 A...100 A 50 A...125 A
Bw	VG 95345, part 17	DC 28 V	60 A...100 A
Bw	LN 29808	AC 115 V, 400 Hz DC 28 V	80 A, 100 A 80 A, 100 A
QPL Canada Dep. of National Defence	VG 95345, part 17	DC 28 V	60 A...100 A
QPL Sweden Defence Material Admin.	TL 5925-001	DC 28 V	60 A...100 A



452-...

## Technical data

For further details please see: [www.e-t-a.de/ti\\_e](http://www.e-t-a.de/ti_e)

Voltage rating	DC 28 V	
Current rating range	50...100 A	
Auxiliary circuit	0.5 A, DC 28 V	
Typical life	2,500 operations at I <sub>N</sub>	
Ambient temperature	-55...+75 °C (-67...+167 °F)	
Insulation co-ordination (IEC 60664 and 60664A)	rated impulse withstand voltage 1.5 kV	pollution degree 3
Dielectric strength (IEC 60664 and 60664A) operating area	test voltage AC 1,500 V	
Insulation resistance	> 100 MΩ (DC 500 V)	
Interrupting capacity I <sub>cn</sub>	6,000 A	
Degree of protection (IEC 60529/DIN 40050)	operating area IP40 terminal area IP00	
Vibration	10 g (55-2000 Hz), ± 0.76 mm (10-55 Hz) to VG 95210, sheet 19, IEC 60068-2-6, test Fc	
Shock	50 g (11 ms) to VG 95210, sheet 28, IEC 60068-2-27, test Ea	
Corrosion	96 hours at 5 % salt mist to VG 95210, sheet 2, IEC 60068-2-11, test Ka	
Humidity	240 hours at 95 % RH to VG 95210, sheet 7, IEC 60068-2-3, test C	
Explosion	to VG 95210, sheet 10, MIL-STD-202, meth. 109	
Mass	approx. 122 g	

All dimensions without tolerances are for reference only. In the interest of improved design, performance and cost effectiveness the right to make changes in these specifications without notice is reserved. Product markings may not be exactly as the ordering codes. Errors and omissions excepted.

**Dimensions 452-K...-...**

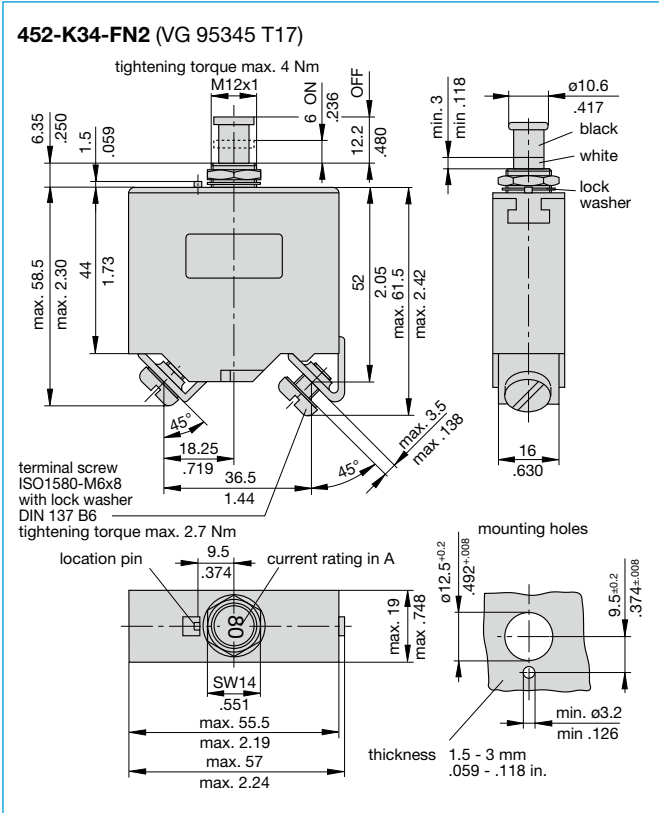

**Internal connection diagram**

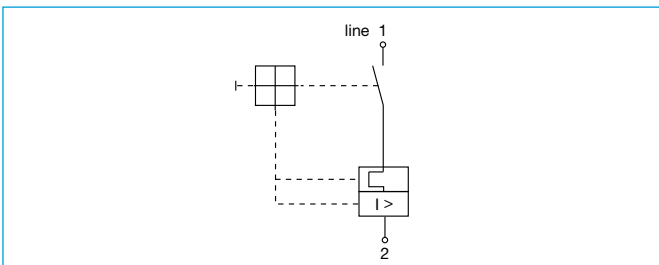

**Typical time/current characteristics**

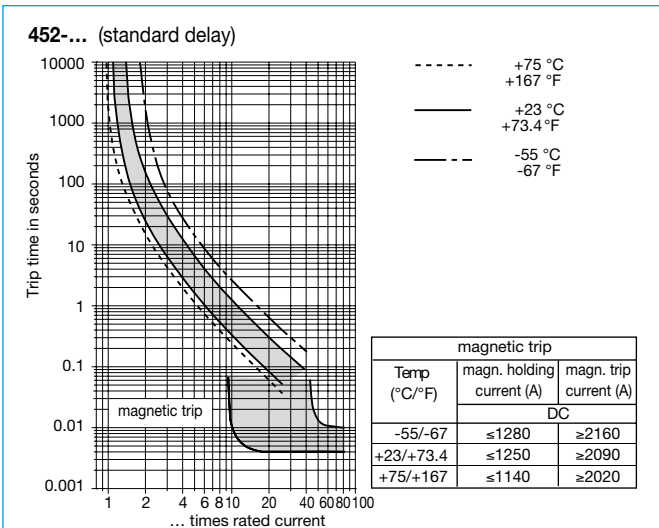

This is a metric design and millimeter dimensions take precedence (mm/inch)

**Accessories (approved to VG 95345, part 23)**

- Splash cover/hex nut assembly with O ring (IP66 and IP67)
- X 200 801 08 nickel plated nut, transparent cover
- X 200 801 03 matt black finish nut, black cover
- X 200 801 12 with blackened nut and transparent cover

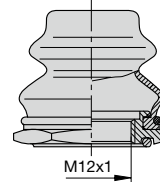

- Splash cover/hex nut assembly with O ring (IP54)
- X 200 802 01 nickel plated nut
- X 200 802 02 matt black finish nut

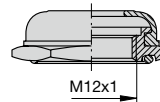

- Actuator extension (black) to be fitted on the push button
- X 200 803 01

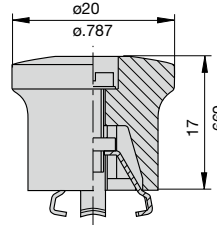

**Accessories**

- Identification collar to be snapped on the push button

- Y 307 004 01 black
- Y 307 004 02 white
- Y 307 004 03 red
- Y 307 004 04 green
- Y 307 004 05 blue

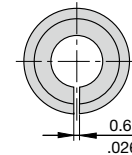
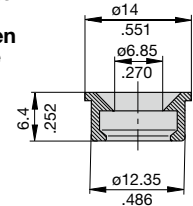

- Lock out ring to block the push button in OFF position

- Y 307 005 01 red
- Y 307 005 02 black

