

# User Guide

## Sentrius<sup>™</sup> RS1xx Multi-Sensor External Open/Closed and Integrated Temperature/Humidity Sensor

*Version 1.1*

---

## REVISION HISTORY

Version	Date	Notes	Contributors	Approver
1.0	02 Apr 2020	Initial Release	Greg Leach & Robert Gosewehr	Chris Boorman
1.1	04 June 2020	Cayenne format update	Greg Leach	Chris Boorman

## CONTENTS

1	Introduction.....	4
2	Descriptions and Ordering Information.....	4
3	Installation.....	5
3.1	Illustrations.....	6
3.1.1	Open/Closed Sensor with RJ45 Cable Assembly.....	6
3.1.2	RJ45 Cable Gland.....	7
4	Configuration.....	8
4.1	Open Dwell Time.....	8
4.2	Closed Dwell Time.....	8
4.3	Resend Interval.....	8
4.4	Notification Options.....	8
5	Connection Status.....	9
6	Data Configuration and Visualization.....	10
6.1	Sentrius Sensor Mobile App.....	10
6.1.1	Open/Closed Sensor Configuration.....	10
6.1.2	Temperature/Humidity Configuration.....	11
7	Battery Consumption.....	13
8	Appendix A – Cayenne Packet Format.....	14
9	Appendix B – Open/Closed State Machine.....	15

## 1 INTRODUCTION

This user guide explains how to properly install the Laird Connectivity Sentries™ RS1xx Multi-Sensor – External Open/Closed cable assembly and view sampled data using the Sentries Sensor mobile app.

This variant of the Sentries RS1xx series of LoRaWAN/Bluetooth LE sensors enables use of an external Open/Closed sensor. The kit includes an IP67-rated Open/Closed sensor (dimensions defined below) and a cabled connection to the enclosure (cable length defined below).

The external Open/Closed sensor has a typical operating range of 25 ~ 35 millimeters at ambient temperature – actual range may vary depending on environment.

The cabled sensor connects into the main body of the Sentries Sensor via a CAT5 IP67-rated RJ45 connector.

---

**Note:** This guide serves as a brief walkthrough. Refer to the RS1xx Guide for further details on sensor functionality and the mobile app capabilities. The RS1xx User Guide is in the documentation section of the [RS1xx product page](#).

---

## 2 DESCRIPTIONS AND ORDERING INFORMATION



*Figure 1: IP67-rated, CAT5, RJ45 connector, 1830 mm cable length, 29 mm (L) x 19 mm (W) x 7 mm (H) Open/Closed sensor housing*



*Figure 2: Sentries™ RS1xx LoRaWAN Ext. Port sensor*

---

**Note:** The external Open/Closed cable assembly is ordered separately from the sensor body, in single units or bulk cartons.

---

See the [RS1xx product page](#) for ordering information.

### 3 INSTALLATION

To install the external Open/Closed cable assembly, refer to *Figure 3* and follow these steps:

1. Unscrew the Ethernet cap (1) from the Sentries sensor.
2. Connect the RJ45 connector from the cable assembly into the external port of the Sentries Sensor.
3. Screw on (by hand) the top portion of the cable gland – the screw nut (3) – until tight.
4. Visually check to ensure the lower portion of the cable gland – the pressing screw (2) – is also tight.



**Figure 3: Installing the external Open/Closed sensor**

---

**Note:** Ensure that references (2) and (3) in *Figure 3* are tight when installing the external Open/Closed cabled assembly into the Sentries sensor. If these areas are not sufficiently tightened, this could lead to a potential leak and cause damage to the sensor's external port connector or to the Open/Closed sensor itself.

---

### 3.1 Illustrations

#### 3.1.1 Open/Closed Sensor with RJ45 Cable Assembly

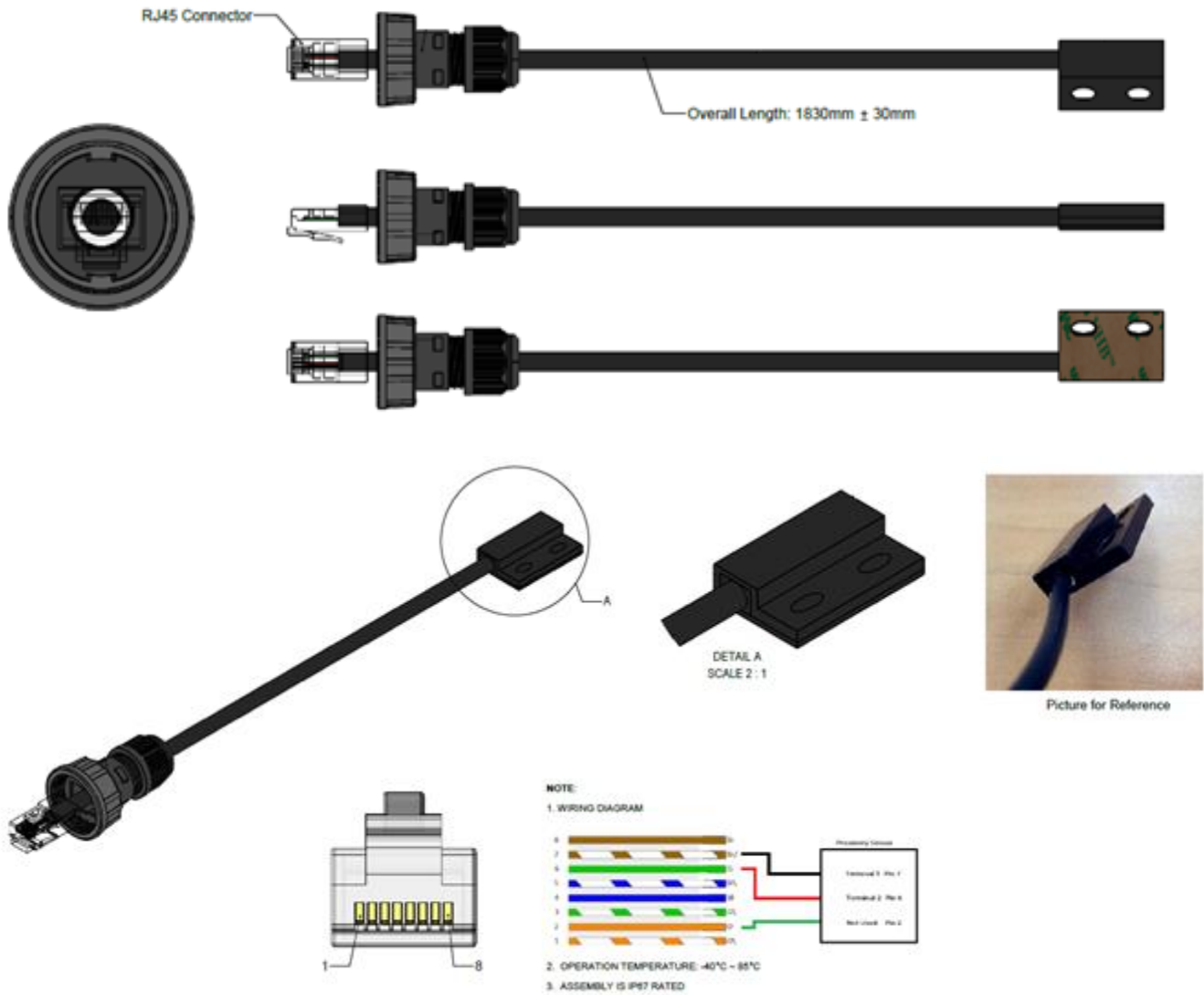
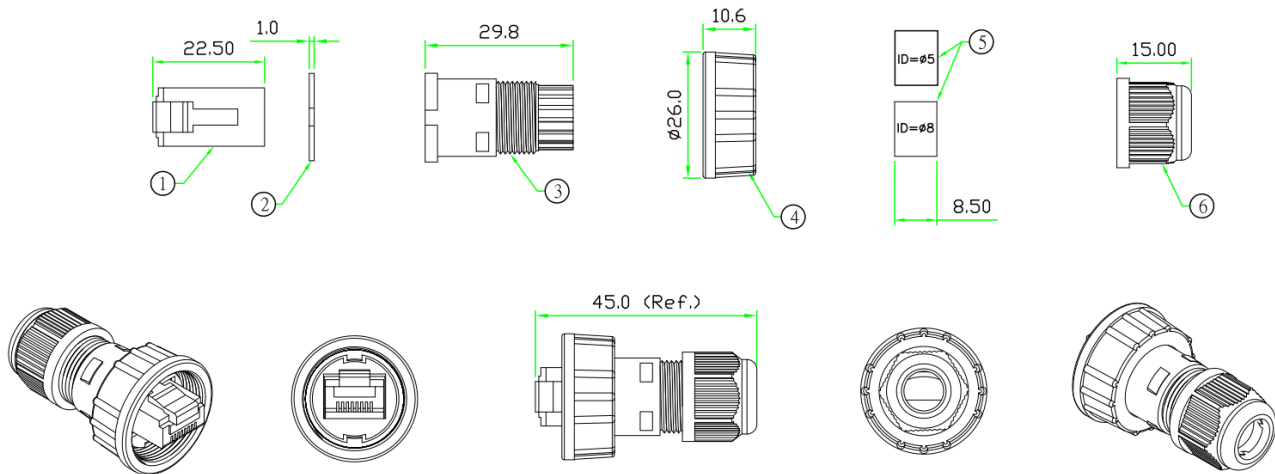

Figure 4: Open/Closed sensor with wiring diagram and RJ45 cable assembly

### 3.1.2 RJ45 Cable Gland

(dimensions in millimeters)



6	SCREW	PRESSING SCREW, NYLON.	BLACK	1
5	SEAL	SANTOPRENE. for cable OD: 3~5mm & 5~8mm.	BLACK	2
4	SCREW NUT	SCREW NUT, NYLON+GF.	BLACK	1
3	SLEEVE	CABLE SLEEVE, NYLON.	BLACK	1
2	GASKET	RUBBER	BLACK	1
1	RJ-45 PLUG	RJ-45 8P8C SHIELDED PLUG.		1

Figure 5: RJ45 cable gland

## 4 CONFIGURATION

The following parameters can be configured to determine the operation of the Open/Closed Sentrius Sensor variant.

### 4.1 Open Dwell Time

This is the length of time in seconds that an Open/Closed sensor must remain in a consistent Open state before an Open Alert message is sent by the sensor. Refer to [Section 9](#) for further details.

---

**Note:** Alert messages for an Open sensor state will not be transmitted if the Open Notification Option is not set.

---

### 4.2 Closed Dwell Time

This is the length of time in seconds that an Open/Closed sensor must remain in a consistent Closed state before a Closed Alert message is sent by the sensor. Refer to [Section 9](#) for further details.

---

**Note:** Alert messages for a Closed sensor state will not be transmitted if the Closed Notification Option is not set.

---

### 4.3 Resend Interval

Upon an Open/Closed sensor sending an Alert message, the Resend Interval determines the time in minutes after which the Alert message is resent. Refer to [Section 9](#) for further details.

---

**Note:** Alert messages for Open and Closed sensor states will not be re-sent if the Resend Notification Option is not set.

---

### 4.4 Notification Options

Notification Options determine what messages are sent over the LoRa network by the sensor. These are described in [Error! Reference source not found.](#)

**Table 1: Open/Closed sensor LoRa notification options**

Value	Notification Option	Purpose
1	Open	When set, Alert messages are sent to indicate an Open sensor status.
2	Closed	When set, Alert messages are sent to indicate a Closed sensor status.
4	Resend	When set, Alert messages according to the current sensor state are sent after the interval defined by the Resend Interval parameter.
8	Cancel	When set, Cancel messages are sent when a change in the sensor state is initially detected.

---

**Note:** Cancel messages indicate when a change in the sensor state has been detected. An Open or Closed alert will not be sent until the appropriate Dwell Time has been exceeded. Cancel messages can be used to determine when the initial change of sensor state was detected.

---



## 5 CONNECTION STATUS

When the external Open/Closed cable assembly is connected properly to the sensor, the sensor operates normally once powered up. Normal operation of the sensor is indicated by the left LED flashing either an orange or green color to indicate the connection status to a network.

If there is a connection problem at power up, both LEDs on the front panel remain constantly illuminated. This is a visual indicator to the user that there is a communication issue between the sensor enclosure and the external sensor assembly. If the sensor cannot detect the external Open/Closed sensor, it does not function properly.

To remedy this, follow these steps:

1. Retry the steps from the [Installation](#) section. Make sure the sensor has the latest firmware installed to ensure all the latest capabilities. The firmware can be updated using the Sentries Connect mobile app. Reference the RS1xx guide on the [RS1xx product page](#) for more details on this process.
2. The sensor monitors the status of the external sensor on each Open/Closed status update. If the Open/Closed sensor electronics are damaged, the LoRa and BLE status LEDs are held permanently on. The LoRa status LED flashes at the heartbeat interval to indicate a network connection.
3. If you continue to experience an issue, contact [Laird Connectivity Support](#). There could be damage to the Sentries sensor or the Open/Closed cable assembly.



**Figure 6: Front panel LEDs are lit**

## 6 DATA CONFIGURATION AND VISUALIZATION

### 6.1 Sentries Sensor Mobile App

The Sentries mobile application allows a user to configure a device, troubleshoot a device, see real-time sensor data, and update firmware. Search the appropriate app store ([Google Play Store](#) or [Apple Store](#)) for the Sentries Sensor App and install it on your device.

**Note:** This guide only contains a brief walkthrough. Refer to the RS1xx Guide for further details on sensor functionality, setup and the mobile app capabilities. The RS1xx User Guide is located in the documentation section of the [RS1xx product page](#).

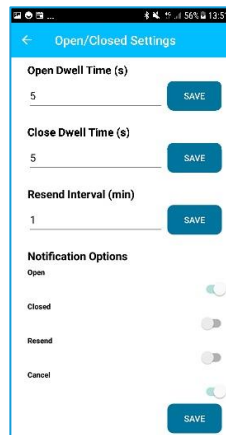
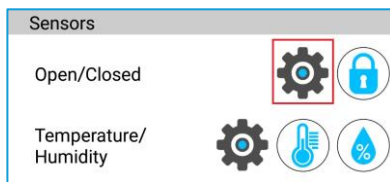

#### 6.1.1 Open/Closed Sensor Configuration



The Open Dwell Time, Close Dwell Time, Resend Interval and Notification Options can be configured. See [Configuration](#) section for more information.

The Sentries sensor mobile app displays real-time sensor data from the external Open/Closed sensor once a good cable connection is established.

To view real-time sensor data, follow these steps:

1. Press and briefly hold the BLE button  on the front panel of the sensor to start BLE advertising on the device.
2. Select the corresponding DEV EUI on the connection screen of the mobile app. This will match the DEV EUI printed on the back label of the sensor.
3. Once connected to the mobile app, click the Open/Closed status icon  under the 'Sensors' section to see real-time sensor data from the Open/Closed sensor.

From this screen, validate the Open/Closed state by checking its reported state in the app. Move the magnet against and away from the sensor, leaving it connected for long enough so the status updates (aligned with the dwell time configured), to observe the Open/Closed status change.

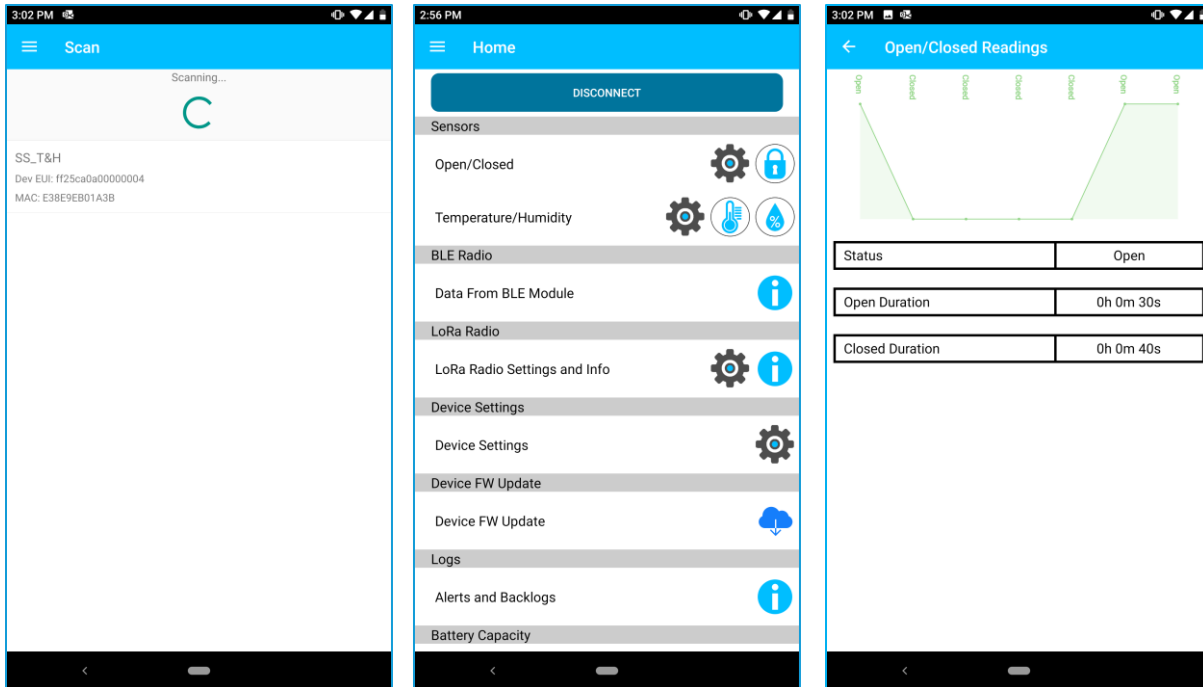
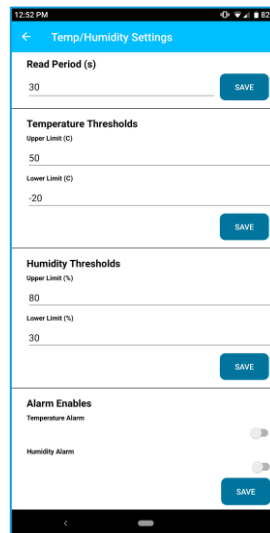

Figure 7: Sentrius sensor mobile app displays – Open/Closed



## 6.1.2 Temperature/Humidity Configuration



The Read Period, Aggregate Count, Temperature/Humidity Thresholds and Alarm enabling can be configured. See the main RS1xx Guide available on the [RS1xx product page](#) for more information.

The Sentries sensor mobile app displays real-time sensor data from the internal temp/humidity sensor.

To view real-time sensor data, follow these steps:

1. Press and briefly hold the BLE button  on the front panel of the sensor to start BLE advertising on the device.
2. Select the corresponding DEV EUI on the connection screen of the mobile app. This matches the DEV EUI printed on the back label of the sensor.
3. Once connected to the mobile app, click either the Temperature or Humidity status icons  under the Sensors section to see real-time sensor data from the temperature/humidity sensors respectively.

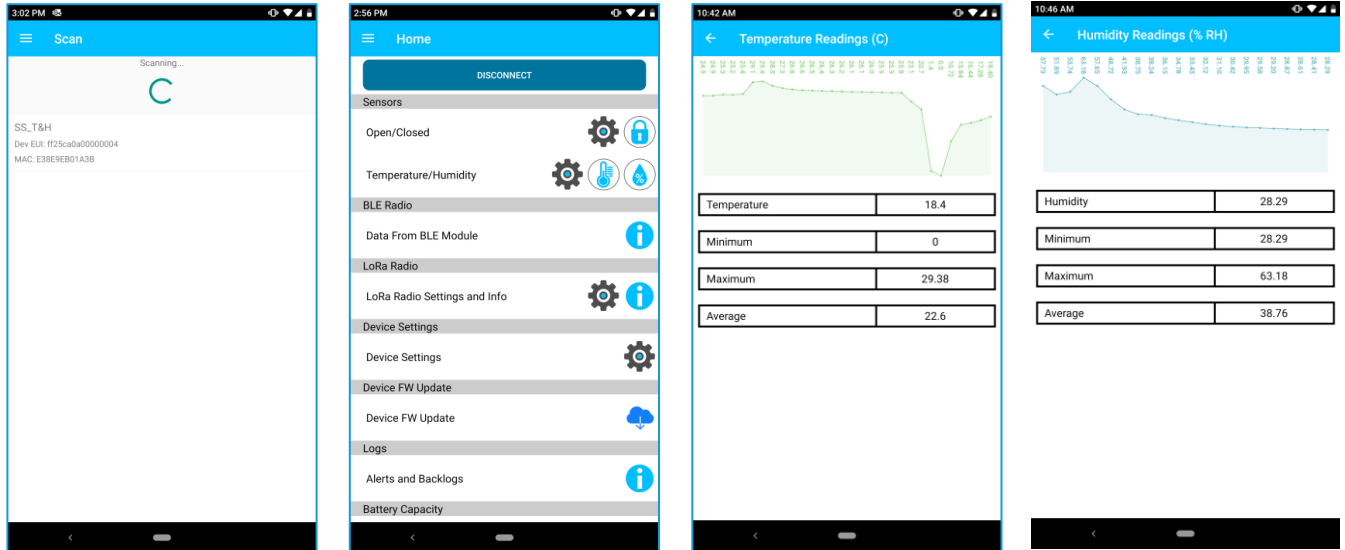

Figure 8 - Sentries sensor mobile app displays – Temp/Humidity

## 7 BATTERY CONSUMPTION

To measure average power consumption, we configured an RS186 for a read period of 300 seconds with an aggregate of three. We performed a power analysis for 32 minutes to ensure two LoRa transmit events were captured.



**Figure 9: RS186 power consumption**

The average current consumption was 91 μA over 32 minutes. The data rate that the RS186 transmitted at was SF7BW125.

## 8 APPENDIX A – CAYENNE PACKET FORMAT

A full description of the Cayenne system can be found at:  
<https://github.com/myDevicesIoT/cayenne-docs/blob/master/docs/LORA.md>.

For the Open/Closed sensor variant, packets are sent to indicate the condition of the sensor. The format of the packets is shown in **Error! Reference source not found.**

Table 2: Cayenne Open/Closed sensor packet format

Index	Value	Description
0	0x04	Data Channel
1	0x66	Presence Data Header
2	0xXX	Open/Closed sensor status, 0 = Closed, 1 = Open