

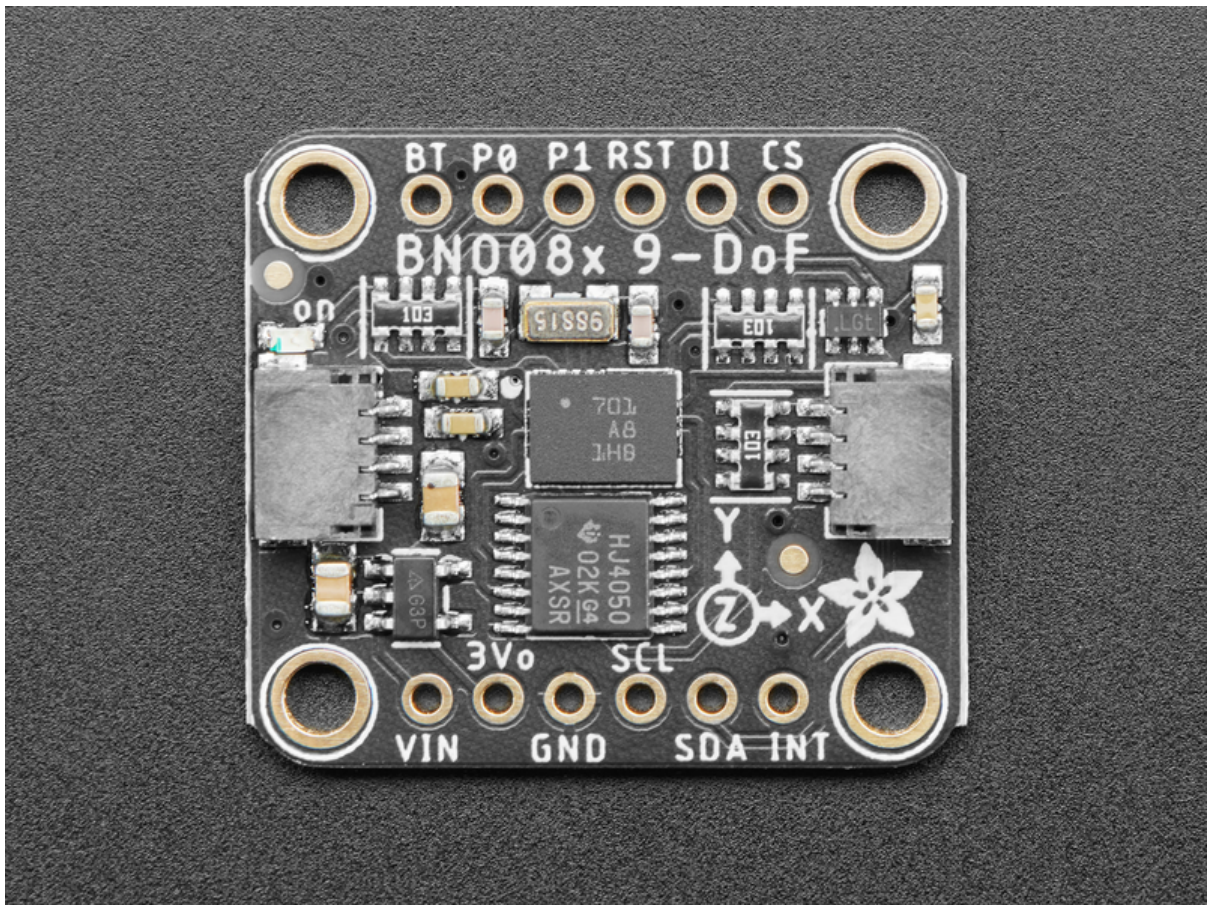

Adafruit 9-DOF Orientation IMU Fusion Breakout - BNO085

Created by Bryan Siepert



<https://learn.adafruit.com/adafruit-9-dof-orientation-imu-fusion-breakout-bno085>

Last updated on 2021-11-15 08:09:53 PM EST

Table of Contents

Overview	5
• A firehose of information in a human-friendly package	7
Pinouts	9
• Power Pins	9
• I2C Logic Pins	9
• UART Logic Pins	10
• SPI Logic pins:	10
• Other Pins	11
Arduino	11
• I2C Wiring	12
• UART Wiring	13
• SPI Wiring	13
• Library Installation	14
• Load Example	14
• Example Code	15
UART-RVC for Arduino	16
• Library Installation	16
• UART RVC Wiring	17
• Load Example - Serial Console	17
• Load Example - Serial Plotter	18
Arduino Docs	20
Arduino UART RVC Docs	20
Python & CircuitPython	20
• CircuitPython I2C Wiring	20
• CircuitPython UART Wiring	21
• Python Computer Wiring	22
• Python UART Wiring	23
• CircuitPython Installation of BNO08x Library	23
• Python Installation of BNO08x Library	24
• CircuitPython & Python Usage	24
• Example Code	26
UART-RVC for Python & CircuitPython	27
• Hardware Setup	27
• CircuitPython Installation of BNO08x_RVC Library	28
• Python Installation of BNO08x RVC Library	29
• CircuitPython & Python Usage	29
• UART Initialization - CircuitPython	29
• UART Initialization - Python	30
• BNO08x_RVC creation and usage	30
• Example Code	30
Python Docs	31
Python UART RVC Docs	31

Report Types	31
• Motion Vectors	32
• Rotation Vectors	33
• Classification Reports	33
• Other Motion Reports	34
• Additional Reports	35
Downloads	35
• Files	35
• Schematic	35
• Fab Print	36

Overview

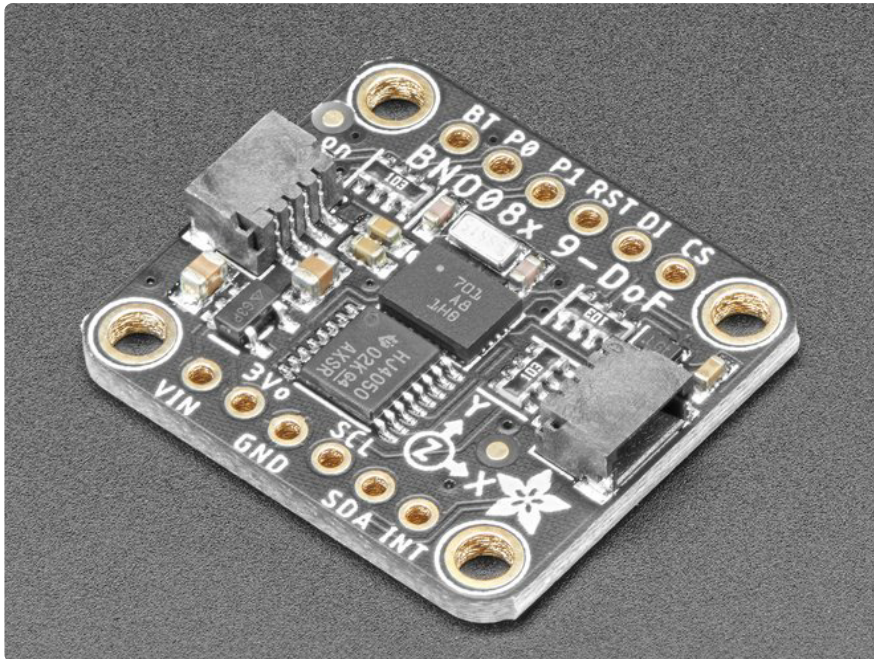

Here it is, the motion sensor you were looking for: the one that just gives you the directly usable information without requiring you to first consult with a PhD to learn the arcane arts of Sensor Fusion. The BNO085 takes the life's work of multiple people who have spent their entire career focused on how to get useful information from direct motion sensor measurements and then squeezes that information down into a 5.2x3.8mm box, along with the sensors to go along with it.

The BNO085 by the motion sensing experts at Hillcrest Laboratories takes the familiar 3-axis accelerometers, gyroscopes, and magnetometers and packages them alongside an Arm Cortex M0 processor running Hillcrest's SH-2 firmware that handles the work of reading the sensors, fusing the measurements into data that you can use directly, and packaging that data and delivering it to you. If the name and description of the BNO085 sounds strikingly similar to those of the BNO055 by Bosch Sensortec, there is a good reason why: they're the same thing, but also they're not. Thanks to a unique agreement between Bosch and Hillcrest, the BNO085 uses the same hardware as the BNO055 but very different firmware running on it.

"How different?" you might ask. Well my friend, pull up a chair and grab a box of popcorn because it's quite a list. First let's list the similarities. The BNO055 and

BNO085 can both deliver the following types of sensor data and sensor fusion products:

- Acceleration Vector / Accelerometer
Three axes of acceleration (gravity + linear motion) in m/s^2
- Angular Velocity Vector / Gyro
Three axes of 'rotation speed' in rad/s
- Magnetic Field Strength Vector / Magnetometer
Three axes of magnetic field sensing in micro Tesla (μT)
- Linear Acceleration Vector
Three axes of linear acceleration data (acceleration minus gravity) in m/s^2
- Gravity Vector
Three axes of gravitational acceleration (minus any movement) in m/s^2
- Absolute Orientation / Rotation Vector
Four-point quaternion output for accurate data manipulation

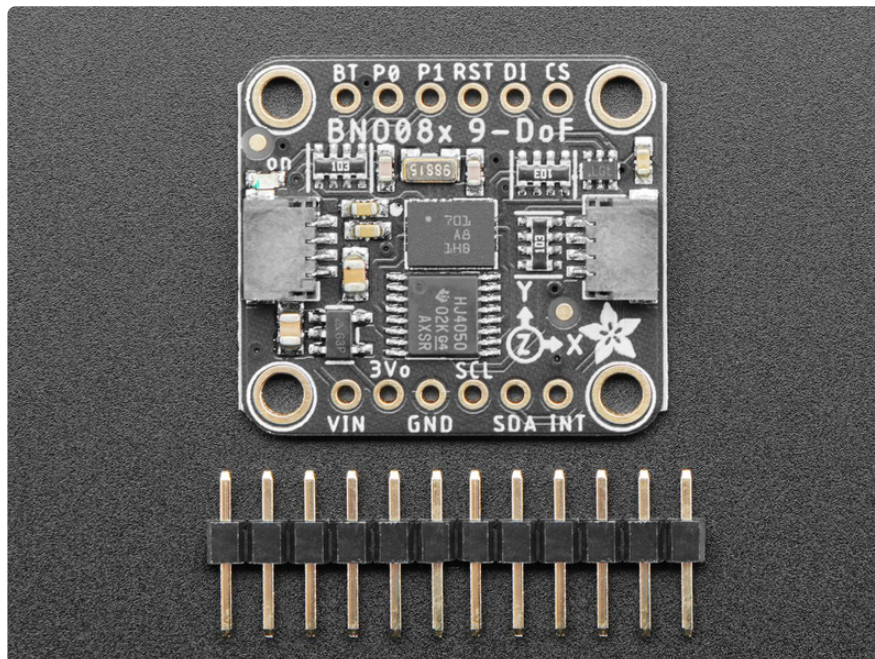

Thanks to the sensor fusion and signal processing wizards from Hillcrest, with the BNO085 you also get:

- Application Optimized Rotation Vectors
For AR/VR, low latency, and low power consumption
- Additional Base Sensor Reports
Separate and simultaneous outputs of Calibrated, Uncalibrated + Correction, and Raw ADC outputs for the Accelerometer, Gyro, and Magnetometer
- Detection and Classification reports:
 - Stability Detection and Classification

- Significant Motion Detector
- Tap, Step, and Shake Detectors
- Activity Classification

As if the above wasn't enough, the BNO085 also provides an impressive suite of detection and classification products by further analyzing the measured motion:

- Stability Detection and Classification
- Tap Detector
- Step Detector
- Step Counter
- Activity Classification
- Significant Motion Detector
- Shake Detector

More information about the various report types is available on the [Report Types \(https://adafru.it/N-A\)](https://adafru.it/N-A) page

A firehose of information in a human-friendly package

The BNO085 is a supremely capable sensor, practically overflowing with useful information. It is also very small. As the [Ideal Gas Law \(https://adafru.it/N-B\)](https://adafru.it/N-B) tells us, when you shove a lot of stuff into a small space, things are going to get a bit spicy. Worry not fellow scientist, we here at Adafruit have done our part to make the BNO085 as approachable as possible. It's a pretty familiar recipe:

Take the following and mix in Eagle CAD:

- One part raw unprocessed Hillcrest Labs brand BNO085
- One voltage regulator for flexible input voltage
- One part Level shifting circuitry for use with 3.3V (RPi/Feather) or 5V(Arduino) logic levels
- Two handy dandy Stemma QT connectors for solderless connection
- One, 32.768kHz crystal to provide a stable reference oscillation
- One breakout PCB with breadboard friendly headers

Prepare in the pick and place and bake in a reflow oven on High for about 5 minutes

and you get the Adafruit BNO085 IMU breakout.

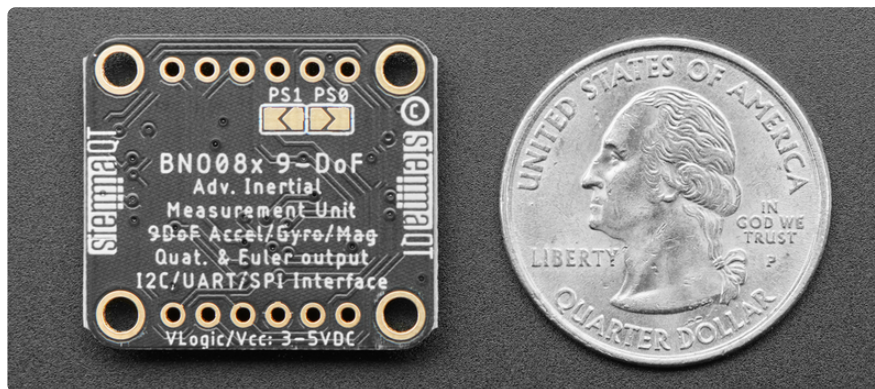

With the physical hardware tamed and made approachable, that leaves the software. If it wasn't already very obvious, the BNO085 can generate a wide selection of data and as a result, it has a slightly complex and unique way of delivering that information. To save you the effort of figuring out how to decode and organize all those measurements, we've written libraries for you to use with CircuitPython and Arduino. Just plug in the sensor to your favorite device using our wiring examples, and install the library for your chosen platform and you're ready to start building your very own Robot Friend.

As an alternative to the cornucopia of vectors and classifications that the standard sensor hub modes provide, the BNO085 also provides a simple but useful and well executed UART-based mode that provides calibrated heading and acceleration measurements. The UART-RVC mode takes its acronym from one of its potential applications: Robot Vacuum Cleaners. This mode is exceedingly simple to interface with, and based on my limited testing, it performs astoundingly well. The ease of use to utility ratio here is off the charts.

We've written libraries for the UART RVC mode for both Arduino and CircuitPython/Python. Check out the UART RVC pages for [Arduino \(https://adafru.it/N-C\)](https://adafru.it/N-C) and [Python \(https://adafru.it/N-D\)](https://adafru.it/N-D) for wiring diagrams and example code

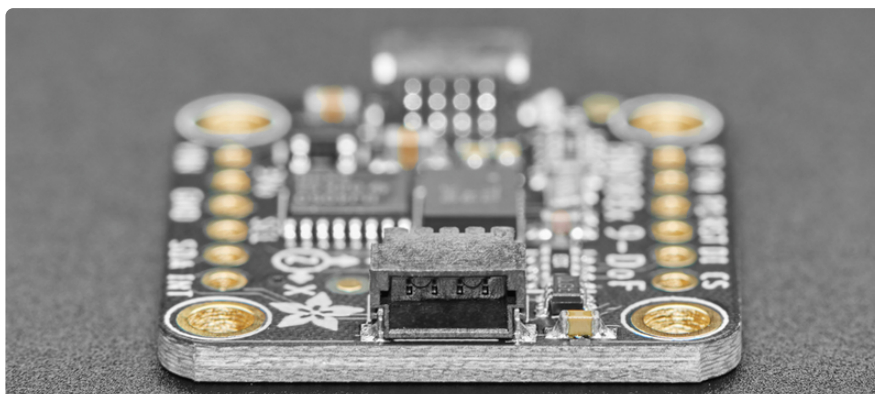

Pinouts

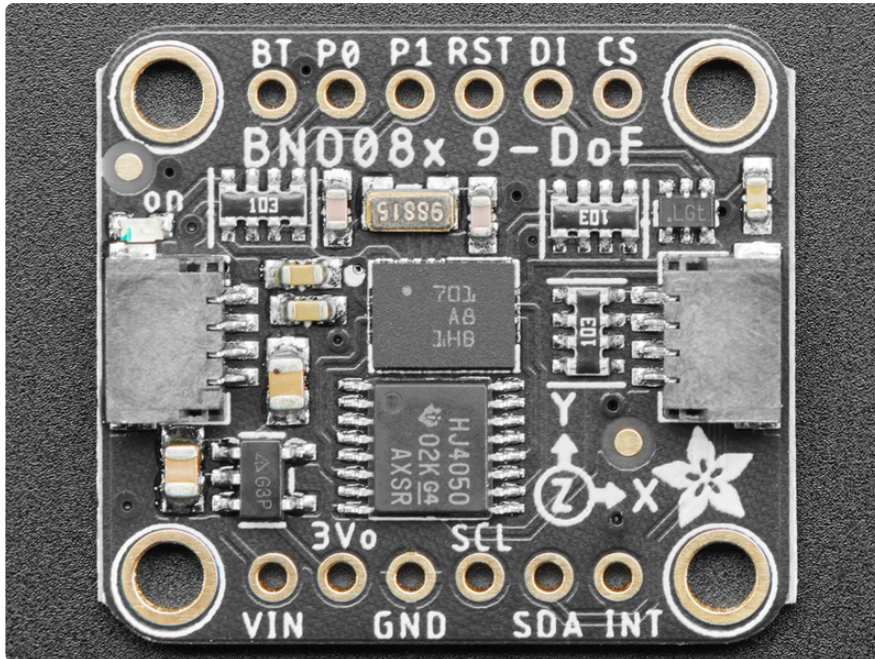

Power Pins

- VIN - this is the power pin. Since the sensor chip uses 3 VDC, we have included a voltage regulator on board that will take 3-5VDC and safely convert it down. To power the board, give it the same power as the logic level of your microcontroller - e.g. for a 5V microcontroller like Arduino, use 5V
- 3Vo - this is the 3.3V output from the voltage regulator, you can grab up to 100mA from this if you like
- GND - common ground for power and logic

I2C Logic Pins

- SCL - I2C clock pin, connect to your microcontroller I2C clock line. This pin is level shifted so you can use 3-5V logic, and there's a 10K pullup on this pin.
- SDA - I2C data pin, connect to your microcontroller I2C data line. This pin is level shifted so you can use 3-5V logic, and there's a 10K pullup on this pin.

Optional:

- [STEMMA QT \(https://adafru.it/Ft4\)](https://adafru.it/Ft4) - A solderless alternative to the Vin, GND, SCL, and SDA pins. These connectors allow you to connect to dev boards

with STEMMA QT connectors and [various associated accessories \(https://adafru.it/Ft6\)](https://adafru.it/Ft6)

- DI - I2C Address pin. Pulling this pin high will change the I2C address from 0x4A to 0x4B

UART Logic Pins

- SCL - UART TX- Connect to your microcontroller RX pin
- SDA - UART RX- Connect to your microcontroller TX pin

SPI Logic pins:

- SCL - This is also the SPI Clock pin / SCK, it's an input to the chip
- SDA - Doubles as the Data Out / Microcontroller In Sensor Out / MISO pin, for data sent from the BNO08x
- DI - Data In / Microcontroller Out Sensor In / MOSI pin, for data sent from your processor to the BNO08x
- CS - this is the Chip Select pin, pull it low to start an SPI transaction. It's an input to the chip
- INT - Interrupt- Active Low. Indicates that the BNO085 needs the host's attention. Required for stable SPI operation
- RST- Reset- Active Low - Pull low to GND to reset the sensor. Required for stable SPI operation

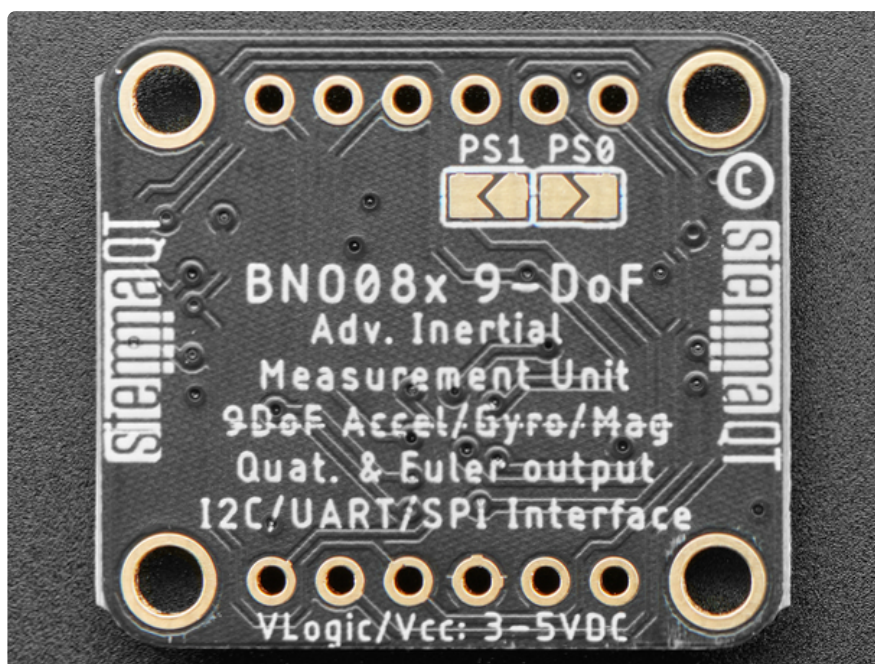

Other Pins

- P0/P1 Pins and Solder Jumpers - Mode select. Use these pins to set the BNO085's operating mode according to the table below. Both pins are pulled low by default, defaulting to I2C
- RST- Reset, Active Low. Pull low to GND to reset the sensor
- INT - Interrupt/Data Ready-Active Low pin. Indicates that the BNO085 needs the host's attention
- BT- Bootloader pin used to put the sensor in bootloader. EXPERT USERS should consult the datasheet for more information. If you don't know what this you probably want to just leave it be or risk damaging your sensor

PS1	PS0	Mode
Low	Low	I2C
Low	High	UART-RVC
High	Low	UART
High	High	SPI

Arduino

Using the BNO08x with Arduino is a simple matter of wiring up the sensor to your Arduino-compatible microcontroller, installing the [Adafruit BNO08x \(https://adafru.it/N-E\)](https://adafru.it/N-E) library, and running the provided example code.

Because of the size and complexity of the BNO08x library, you will have to use an Arduino-compatible with a larger amount of memory such as the SAMD21, SAMD51, nRF52, ESP, Mega, etc. Arduino Uno or Leonardo will not work due to minimal RAM

The examples below show Metro and Feather M4s, and reference their 3.3V logic level for power connections. If using a board with a 5V logic level, connect the BNO085 Vin to 5V instead

I2C Wiring

Use this wiring if you want to connect via I2C interface. The default I2C address for the BNO08x is 0x4A but it can be switched to 0x4B by pulling the DI pin high to VCC.

Here is how to wire up the sensor using one of the [STEMMA QT](https://adafru.it/Ft4) connectors. The examples show a Metro but wiring will work the same for an Arduino or other compatible board.

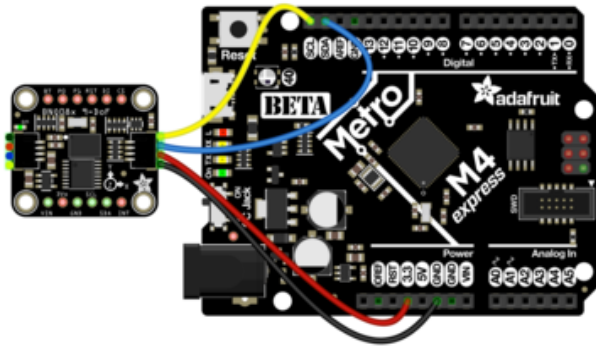

- Connect board VIN (red wire) to Board 3V
- Connect board GND (black wire) to Board GND
- Connect board SCL (yellow wire) to Board SCL
- Connect board SDA (blue wire) to Board SDA

Here is how to wire the sensor to a board using a solderless breadboard:

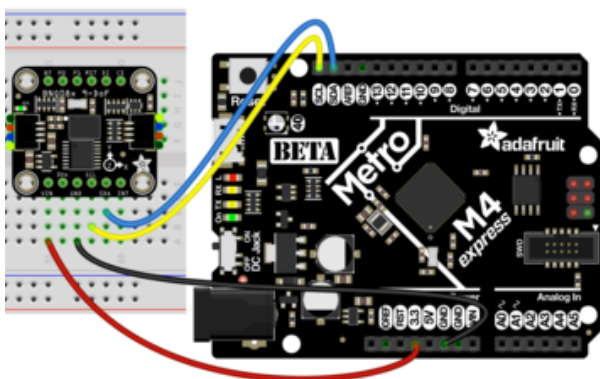

- Connect board VIN (red wire) to Board 3V
- Connect board GND (black wire) to Board GND
- Connect board SCL (yellow wire) to Board SCL
- Connect board SDA (blue wire) to Board SDA

UART Wiring

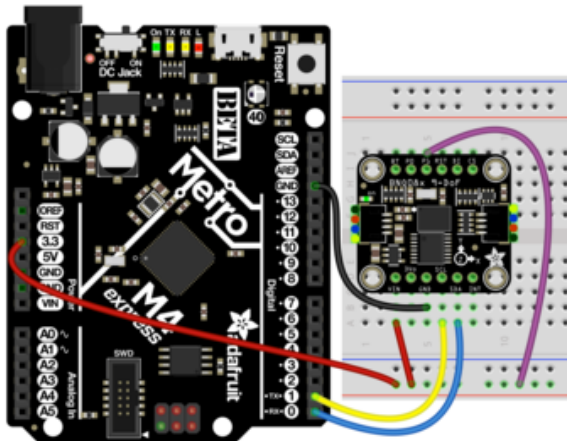

- BNO085 Vin to the power supply, using the same logic level as your microcontroller. For the Metro M4 shown that is 3.3V, however check your board's documentation to be sure
- BNO085 GND to board GND
- BNO085 SCL to board TX
- BNO085 SDA to board RX
- BNO085 P1 to Board Power supply

SPI Wiring

Finally for SPI we are using a Feather M4 for the wiring diagram to make it easier to read. If using an Arduino compatible or other different shaped board, you will still connect to the same pin names to ensure that you use hardware SPI

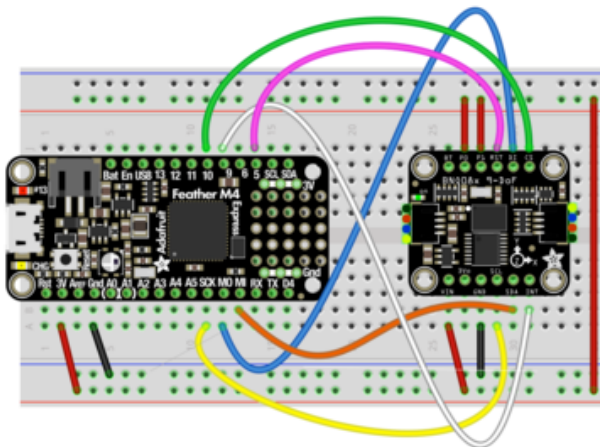

- BNO085 Vin to 3V on the Feather M4
- BNO085 GND to common power/data ground
- BNO085 SCL to the SPI SCK pin on the Feather M4
- BNO085 SDA pin to the SPI MISO pin on the Feather M4
- BNO085 DI to the SPI MOSI pin on the Feather M4
- BNO085 CS to pin #10 on the Feather M4
- BNO085 INT to pin #9 on the Feather M4
- BNO085 RST to pin #5 on the Feather M4
- BNO085 P0 and P1 to 3V on the Feather M4

This is a lot of wires! You may be tempted to omit the INT and RST pin connections but do not! They are required for a good SPI connection

Library Installation

You can install the Adafruit BNO08x library for Arduino using the Library Manager in the Arduino IDE.

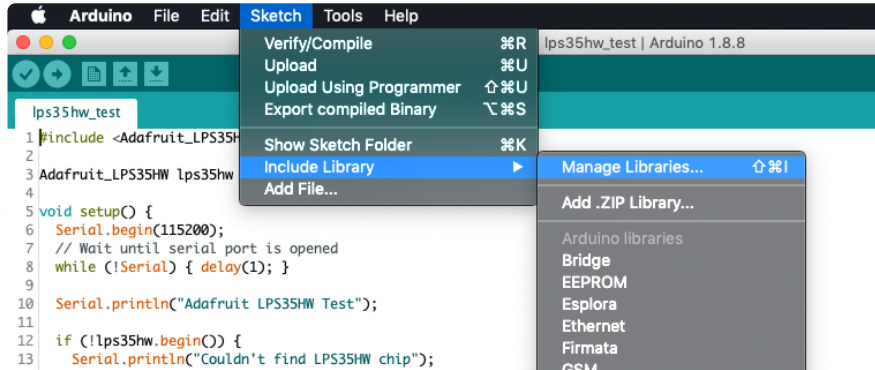

Click the Manage Libraries ... menu item, search for Adafruit BNO08x, and select the Adafruit BNO08x library:

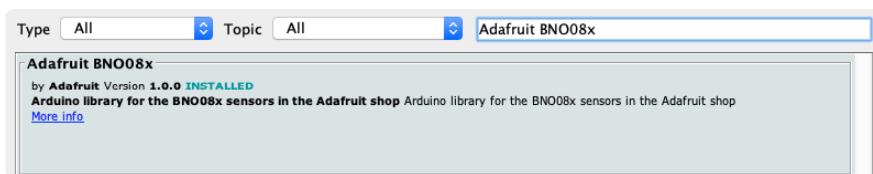

Follow the same process for the Adafruit BusIO library.

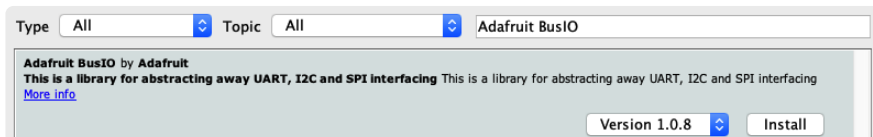

Load Example

This example shows the Rotation Vector report however there are *many* more. See the Report Types page for more information

Open up File -> Examples -> Adafruit BNO08x -> rotation_vector

After opening the demo file, upload the compiled code to your Arduino wired up to the sensor. Once you upload the code, you will see the rotation vector quaternion values being printed when you open the Serial Monitor (Tools->Serial Monitor) at 115200 baud, similar to this:

Example Code

```
Adafruit BN008x test!
BN008x Found!
Part 10004148: Version :3.2.13 Build 6
Part 10003606: Version :1.2.4 Build 230
Part 10003254: Version :4.4.3 Build 485
Part 10003171: Version :4.2.10 Build 548
Setting desired reports
Reading events
Setting desired reports
Game Rotation Vector - r: 1.00 i: -0.08 j: -0.02 k: 0.00
Game Rotation Vector - r: 1.00 i: -0.08 j: -0.02 k: 0.00
Game Rotation Vector - r: 1.00 i: -0.08 j: -0.02 k: 0.00
```

```
// Basic demo for readings from Adafruit BN008x
#include <Adafruit_BN008x.h>

// For SPI mode, we need a CS pin
#define BN008X_CS 10
#define BN008X_INT 9

// For SPI mode, we also need a RESET
// #define BN008X_RESET 5
// but not for I2C or UART
#define BN008X_RESET -1

Adafruit_BN008x bno08x(BN008X_RESET);
sh2_SensorValue_t sensorValue;

void setup(void) {
  Serial.begin(115200);
  while (!Serial) delay(10); // will pause Zero, Leonardo, etc until serial
  console opens

  Serial.println("Adafruit BN008x test!");

  // Try to initialize!
  if (!bno08x.begin_I2C()) {
    //if (!bno08x.begin_UART(&Serial1)) { // Requires a device with > 300 byte UART
    buffer!
    //if (!bno08x.begin_SPI(BN008X_CS, BN008X_INT)) {
      Serial.println("Failed to find BN008x chip");
      while (1) { delay(10); }
    }
    Serial.println("BN008x Found!");

    for (int n = 0; n < bno08x.prodIds.numEntries; n++) {
      Serial.print("Part ");
      Serial.print(bno08x.prodIds.entry[n].swPartNumber);
      Serial.print(" : Version :");
      Serial.print(bno08x.prodIds.entry[n].swVersionMajor);
      Serial.print(".");
      Serial.print(bno08x.prodIds.entry[n].swVersionMinor);
      Serial.print(".");
      Serial.print(bno08x.prodIds.entry[n].swVersionPatch);
      Serial.print(" Build ");
      Serial.println(bno08x.prodIds.entry[n].swBuildNumber);
    }

    setReports();

    Serial.println("Reading events");
    delay(100);
  }

  // Here is where you define the sensor outputs you want to receive
```

```

void setReports(void) {
  Serial.println("Setting desired reports");
  if (! bno08x.enableReport(SH2_GAME_ROTATION_VECTOR)) {
    Serial.println("Could not enable game vector");
  }
}

void loop() {
  delay(10);

  if (bno08x.wasReset()) {
    Serial.print("sensor was reset ");
    setReports();
  }

  if (! bno08x.getSensorEvent(&sensorValue)) {
    return;
  }

  switch (sensorValue.sensorId) {

    case SH2_GAME_ROTATION_VECTOR:
      Serial.print("Game Rotation Vector - r: ");
      Serial.print(sensorValue.un.gameRotationVector.real);
      Serial.print(" i: ");
      Serial.print(sensorValue.un.gameRotationVector.i);
      Serial.print(" j: ");
      Serial.print(sensorValue.un.gameRotationVector.j);
      Serial.print(" k: ");
      Serial.println(sensorValue.un.gameRotationVector.k);
      break;
  }
}

```

UART-RVC for Arduino

Library Installation

You can install the Adafruit BNO08x RVC library for Arduino using the Library Manager in the Arduino IDE.

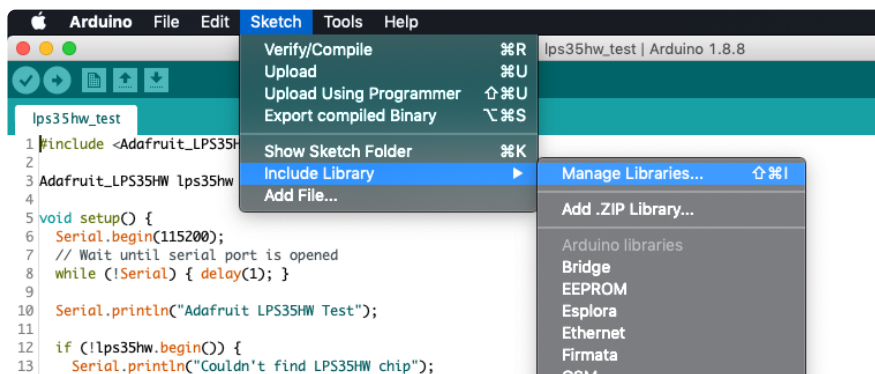

Click the Manage Libraries ... menu item, search for Adafruit BNO08x RVC, and select the Adafruit BNO08x RVC library:

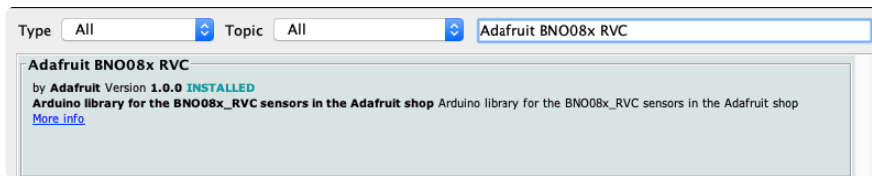

UART RVC Wiring

Wiring up the BNO085 in UART RVC is similar to UART, but with one less wire!

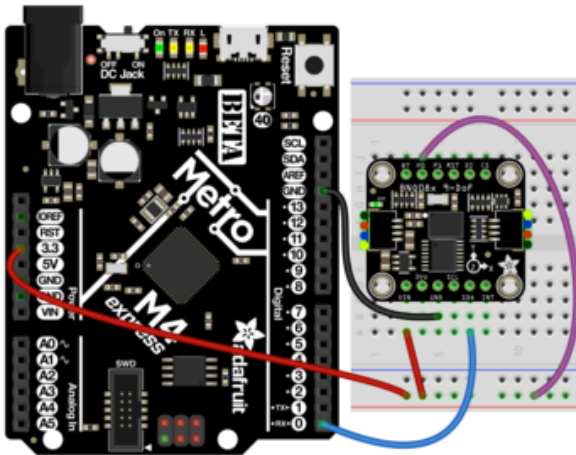

- Board 3V to BNO085 Vin (Red Wire).
- Board GND to BNO085 GND (Black Wire)
- Board RX to BNO085 SDA (Blue Wire)
- Board 3V to BNO085 P0 (Purple Wire)

For an even simpler hardware setup, bridge the P0 solder jumper on the back of the board to keep it configured in UART RVC. mode. You can always remove the solder to use other modes!

Load Example - Serial Console

Open up File -> Examples -> Adafruit BNO08x RVC-> uart_rvc

After opening the demo file, upload to your Arduino wired up to the sensor. Once you upload the code, you will see the heading principal axes and acceleration values being printed when you open the Serial Monitor (Tools->Serial Monitor) at 115200 baud, similar to this:

```

Adafruit BNO08x IMU - UART-RVC mode
BNO08x found!

-----
Principal Axes:
-----
Yaw: 23.70    Pitch: -3.76    Roll: 6.17
-----
Acceleration
-----
X: -0.82    Y: -0.51    Z: 7.50
-----

-----
Principal Axes:
-----
Yaw: 23.70    Pitch: -3.76    Roll: 6.17
-----
Acceleration
-----
X: -0.82    Y: -0.47    Z: 7.53
-----

```

Load Example - Serial Plotter

In addition to the text based example code shown above, we have also included a version that is formatted to display nicely in the Arduino Serial Plotter.

Open up File -> Examples -> Adafruit BNO08x RVC-> uart_rvc_plotter

After opening the demo file, upload to your Arduino wired up to the sensor. Once you upload the code, open the Serial Plotter (Tools->Serial Plotter) at 115200 baud and you will see graphs of the heading and acceleration like these:

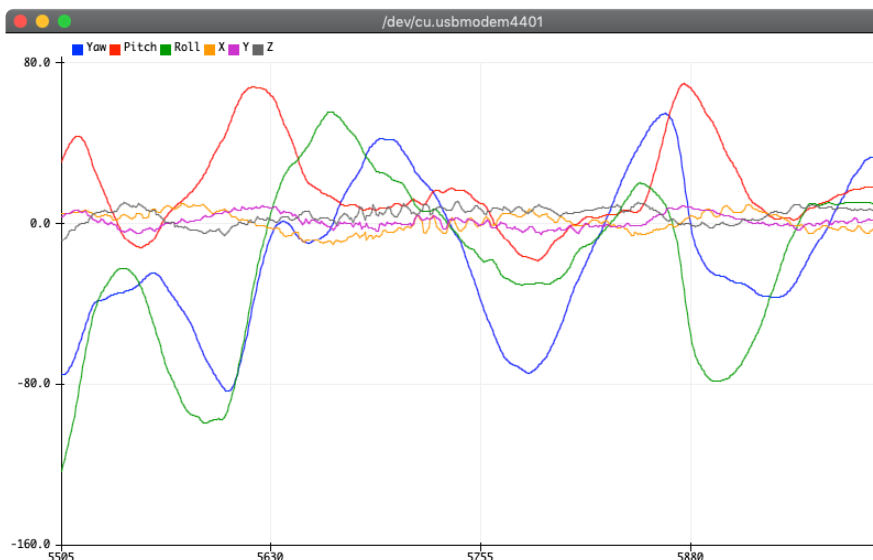

Play around with it! Move the sensor around and see how rolling back and forth, front to back, and twisting change the graphs. I think you'll be pleasantly surprised!

```

/* Test sketch for Adafruit BN008x sensor in UART-RVC mode */
#include "Adafruit_BN008x_RVC.h"

Adafruit_BN008x_RVC rvc = Adafruit_BN008x_RVC();

void setup() {
  // Wait for serial monitor to open
  Serial.begin(115200);
  while (!Serial)
    delay(10);

  Serial.println("Adafruit BN008x IMU - UART-RVC mode");

  Serial1.begin(115200); // This is the baud rate specified by the datasheet
  while (!Serial1)
    delay(10);

  if (!rvc.begin(&Serial1)) { // connect to the sensor over hardware serial
    Serial.println("Could not find BN008x!");
    while (1)
      delay(10);
  }

  Serial.println("BN008x found!");
}

void loop() {
  BN008x_RVC_Data heading;

  if (!rvc.read(&heading)) {
    return;
  }

  Serial.println();
  Serial.println(F("-----"));
  Serial.println(F("Principal Axes:"));
  Serial.println(F("-----"));
  Serial.print(F("Yaw: "));
  Serial.print(heading.yaw);
  Serial.print(F("\tPitch: "));
  Serial.print(heading.pitch);
  Serial.print(F("\tRoll: "));
  Serial.println(heading.roll);
  Serial.println(F("-----"));
  Serial.println(F("Acceleration"));
  Serial.println(F("-----"));
  Serial.print(F("X: "));
  Serial.print(heading.x_accel);
  Serial.print(F("\tY: "));
  Serial.print(heading.y_accel);
  Serial.print(F("\tZ: "));
  Serial.println(heading.z_accel);
  Serial.println(F("-----"));

  // delay(200);
}

```

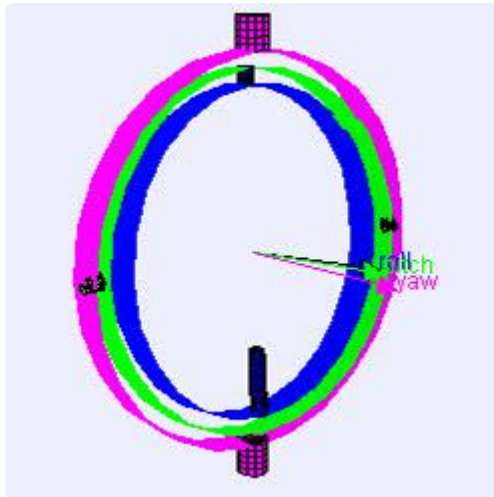

Arduino Docs

[Arduino Docs \(https://adafru.it/Nxf\)](https://adafru.it/Nxf)

Arduino UART RVC Docs

[Arduino UART RVC Docs \(https://adafru.it/NxD\)](https://adafru.it/NxD)

Python & CircuitPython

It's easy to use the BNO08x with Python or CircuitPython, and the [Adafruit CircuitPython BNO08x \(https://adafru.it/N-F\)](https://adafru.it/N-F) module. This module allows you to easily write Python code that reads humidity and temperature from the BNO08x sensor.

You can use this sensor with any CircuitPython microcontroller board or with a computer that has GPIO and Python [thanks to Adafruit_Blinka, our CircuitPython-for-Python compatibility library \(https://adafru.it/BSN\)](https://adafru.it/BSN).

CircuitPython I2C Wiring

First wire up a BNO08x to your board exactly as shown below. Here's an example of wiring a Feather M4 to the sensor with I2C using one of the handy [STEMMA QT \(https://adafru.it/Ft4\)](https://adafru.it/Ft4) connectors:

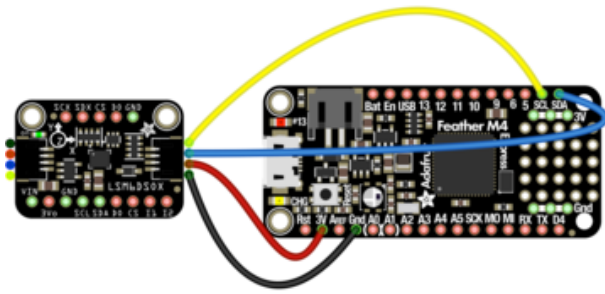

- Board 3V to sensor VIN (red wire)
- Board GND to sensor GND (black wire)
- Board SCL to sensor SCL (yellow wire)
- Board SDA to sensor SDA (blue wire)

You can also use the standard 0.100"/2.54mm pitch headers to wire it up on a breadboard:

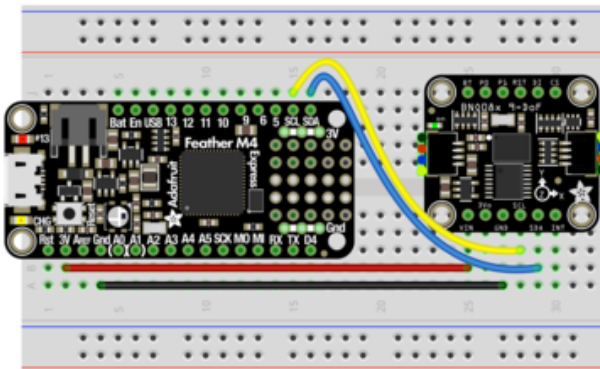

- Board 3V to sensor VIN (red wire)
- Board GND to sensor GND (black wire)
- Board SCL to sensor SCL (yellow wire)
- Board SDA to sensor SDA (blue wire)

CircuitPython UART Wiring

If you wish to use UART, you can enable the UART mode by pulling the P1 pin high and connecting the sensor to your RX and TX pins:

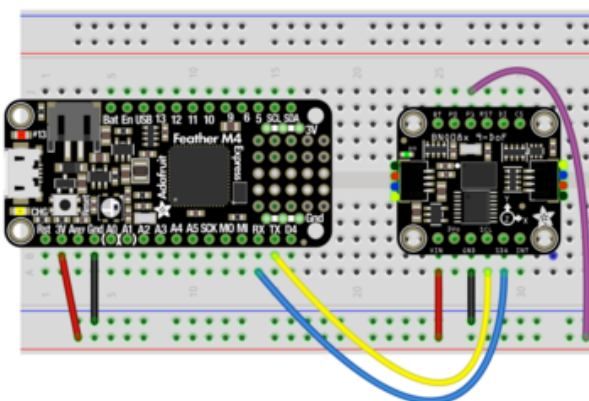

- Board 3V to sensor VIN (red wire)
- Board GND to sensor GND (black wire)
- Board TX to sensor SCL (yellow wire)
- Board RX to sensor SDA (blue wire)
- Board 3V to sensor P1 (purple wire)

Python Computer Wiring

Since there's dozens of Linux computers/boards you can use, we will show wiring for Raspberry Pi. For other platforms, [please visit the guide for CircuitPython on Linux to see whether your platform is supported](https://adafru.it/BSN) (<https://adafru.it/BSN>).

Here's the Raspberry Pi wired to the sensor using I2C and a [STEMMA QT](https://adafru.it/Ft4) (<https://adafru.it/Ft4>) connector:

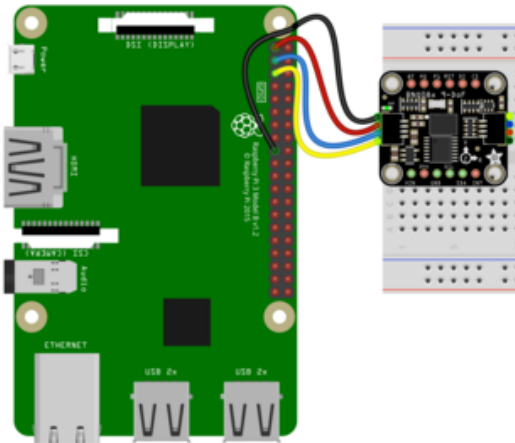

- Pi 3V to sensor VCC (red wire)
- Pi GND to sensor GND (black wire)
- Pi SCL to sensor SCL (yellow wire)
- Pi SDA to sensor SDA (blue wire)

Finally here is an example of how to wire up a Raspberry Pi to the sensor using a solderless breadboard

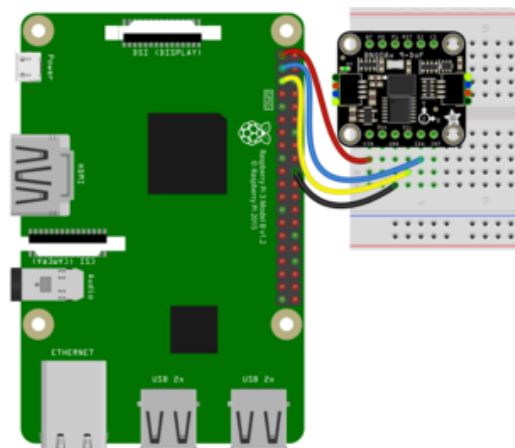

- Pi 3V to sensor VCC (red wire)
- Pi GND to sensor GND (black wire)
- Pi SCL to sensor SCL (yellow wire)
- Pi SDA to sensor SDA (blue wire)

NOTE: The BNO85 seems to work best on the Raspberry Pi with an I2C clock frequency of 400kHz. You can make that change by adding this line to your /boot/config.txt file:

```
dtoverlay=i2c_arm_baudrate=400000
```

and then rebooting.

Python UART Wiring

If you wish to use UART, you can enable the UART mode by pulling the P1 pin high and connecting the sensor to your RX and TX pins:

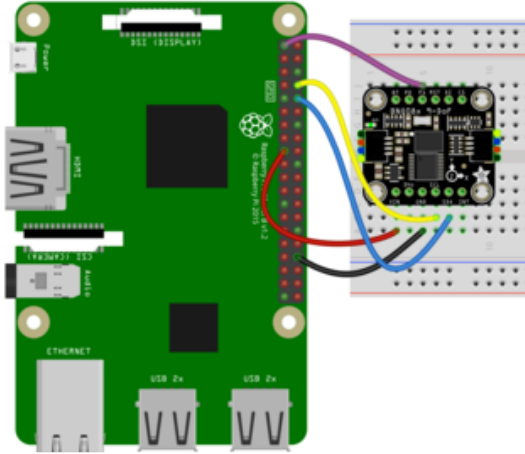

- Pi 3V3 to sensor VIN (red wire)
- Pi GND to sensor GND (black wire)
- Pi TX to sensor SCL (yellow wire)
- Pi RX to sensor SDA (blue wire)
- Pi 3V3 to sensor P1 (purple wire)

CircuitPython Installation of BNO08x Library

You'll need to install the [Adafruit CircuitPython BNO08x \(https://adafru.it/N-F\)](https://adafru.it/N-F) library on your CircuitPython board.

First make sure you are running the [latest version of Adafruit CircuitPython \(https://adafru.it/Amd\)](https://adafru.it/Amd) for your board.

Next you'll need to install the necessary libraries to use the hardware--carefully follow the steps to find and install these libraries from [Adafruit's CircuitPython library bundle \(https://adafru.it/ENC\)](https://adafru.it/ENC). Our CircuitPython starter guide has [a great page on how to install the library bundle \(https://adafru.it/ABU\)](https://adafru.it/ABU).

Before continuing make sure your board's lib folder or root filesystem has the adafruit_t_BNO08x and adafruit_bus_device folders copied over. Both of these are folders with library files in them. Make sure to copy the whole folder for both into your lib folder!

Next [connect to the board's serial REPL \(https://adafru.it/Awz\)](https://adafru.it/Awz) so you are at the CircuitPython >>> prompt.

Python Installation of BNO08x Library

You'll need to install the Adafruit_Blinka library that provides the CircuitPython support in Python. This may also require enabling I2C on your platform and verifying you are running Python 3. [Since each platform is a little different, and Linux changes often, please visit the CircuitPython on Linux guide to get your computer ready \(https://adafru.it/BSN\)](https://adafru.it/BSN)!

Once that's done, from your command line run the following command:

- `sudo pip3 install adafruit-circuitpython-bno08x`

If your default Python is version 3 you may need to run 'pip' instead. Just make sure you aren't trying to use CircuitPython on Python 2.x, it isn't supported!

CircuitPython & Python Usage

The examples below show an I2C connection displaying the Rotation Vector (Quaternion) report however there are many more that can be enabled. See the Report Types page for more information on the available reports

To demonstrate the usage of the sensor we'll initialize it and enable the Rotation Vector report type and display the readings using properties in the CircuitPython REPL

I2C Initialization

If you are using the I2C connection, run the following code to import the necessary modules and initialize the I2C connection with the sensor:

```
import time
import board
import busio
import adafruit_bno08x
from adafruit_bno08x.i2c import BNO08X_I2C

i2c = busio.I2C(board.SCL, board.SDA, frequency=800000)
bno = BNO08X_I2C(i2c)
```

```

>>> import time
>>> import board
>>> import busio
>>> import adafruit_bno08x
>>> from adafruit_bno08x.i2c import BNO08X_I2C
>>>
>>> i2c = busio.I2C(board.SCL, board.SDA, frequency=800000)
>>> bno = BNO08X_I2C(i2c)
>>>

```

UART Initialization - CircuitPython

If you are using the UART connection with a board (like a Feather) running CircuitPython, create your sensor object as follows:

```

import adafruit_bno08x
from adafruit_bno08x.uart import BNO08X_UART

import board
import busio
uart = busio.UART(board.TX, board.RX, baudrate=3000000, receiver_buffer_size=2048)

bno = BNO08X_UART(uart)

```

```

>>> import time
>>> import board
>>> import busio
>>> import adafruit_bno08x
>>> from adafruit_bno08x.uart import BNO08X_UART
>>>
>>>
>>> uart = busio.UART(board.TX, board.RX, baudrate=3000000, receiver_buffer_size=2048)
>>> bno = BNO08X_UART(uart)
Soft resetting...OK!

```

UART Initialization - Python

Check how your specific board supports UART and where the port entry is created and named. For the Raspberry Pi, this is done using the `pyserial` module and the UART used is `/dev/serial0`. Then you create your sensor object as follows:

```

import adafruit_bno08x
from adafruit_bno08x.uart import BNO08X_UART

import serial
uart = serial.Serial("/dev/serial0", 115200)

bno = BNO08X_UART(uart)

```

Enable the Rotation Vector/Quaternion Report

Once the connection to the sensor is established we can enable one or more report types and the associated property

```

bno.enable_feature(adafruit_bno08x.BNO_REPORT_ROTATION_VECTOR)

```



```
>>> bno.enable_feature(adafruit_bno08x.BNO_REPORT_ROTATION_VECTOR)
>>>
```

Now you're ready to read values from the sensor using the quaternion property. This is a 4-tuple of orientation quaternion values.

```
print("Rotation Vector Quaternion:")
quat_i, quat_j, quat_k, quat_real = bno.quaternion
print(
    "I: %0.6f J: %0.6f K: %0.6f Real: %0.6f" % (quat_i, quat_j, quat_k, quat_real)
)
```

```
>>> print("Rotation Vector Quaternion:")
Rotation Vector Quaternion:
>>> quat_i, quat_j, quat_k, quat_real = bno.quaternion
>>> print(
...   "I: %0.6f J: %0.6f K: %0.6f Real: %0.6f" % (quat_i, quat_j, quat_k, quat_real)
... )
I: 0.178589 J: -0.044067 K: -0.929871 Real: 0.318542
>>>
```

Example Code

```
# SPDX-FileCopyrightText: 2020 Bryan Siepert, written for Adafruit Industries
#
# SPDX-License-Identifier: Unlicense
import time
import board
import busio
from adafruit_bno08x import (
    BNO_REPORT_ACCELEROMETER,
    BNO_REPORT_GYROSCOPE,
    BNO_REPORT_MAGNETOMETER,
    BNO_REPORT_ROTATION_VECTOR,
)
from adafruit_bno08x.i2c import BN008X_I2C

i2c = busio.I2C(board.SCL, board.SDA, frequency=400000)
bno = BN008X_I2C(i2c)

bno.enable_feature(BNO_REPORT_ACCELEROMETER)
bno.enable_feature(BNO_REPORT_GYROSCOPE)
bno.enable_feature(BNO_REPORT_MAGNETOMETER)
bno.enable_feature(BNO_REPORT_ROTATION_VECTOR)

while True:
    time.sleep(0.5)
    print("Acceleration:")
    accel_x, accel_y, accel_z = bno.acceleration # pylint:disable=no-member
    print("X: %0.6f Y: %0.6f Z: %0.6f m/s^2" % (accel_x, accel_y, accel_z))
    print("")

    print("Gyro:")
    gyro_x, gyro_y, gyro_z = bno.gyro # pylint:disable=no-member
    print("X: %0.6f Y: %0.6f Z: %0.6f rads/s" % (gyro_x, gyro_y, gyro_z))
    print("")

    print("Magnetometer:")
    mag_x, mag_y, mag_z = bno.magnetic # pylint:disable=no-member
    print("X: %0.6f Y: %0.6f Z: %0.6f uT" % (mag_x, mag_y, mag_z))
    print("")

    print("Rotation Vector Quaternion:")
```

```
quat_i, quat_j, quat_k, quat_real = bno.quaternion # pylint:disable=no-member
print(
    "I: %0.6f J: %0.6f K: %0.6f Real: %0.6f" % (quat_i, quat_j, quat_k,
    quat_real)
)
print("")
```

UART-RVC for Python & CircuitPython

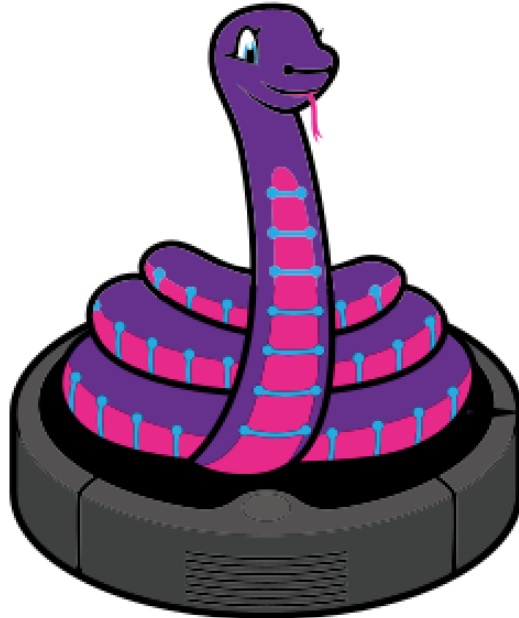

Hardware Setup

The hardware setup for the UART-RVC mode should probably be called easyware because of how simple it is. Three wires and a solder jumper (or an additional jumper wire) and you're off to the autonomous vacuum cleaner races.

UART-RVC Wiring

To allow your device to listen to the heading and acceleration data being output by the BNO085 requires just a few connections. It's similar to the connections for the UART mode, but because there is no software configuration of the BNO085 required, you only need to connect your device's RX pin and pull the P0 pin high. The TX pin on your device can be left unattached

Here we show the Wiring for a Feather M4 for CircuitPython, and a Raspberry Pi for Python:

Feather Wiring

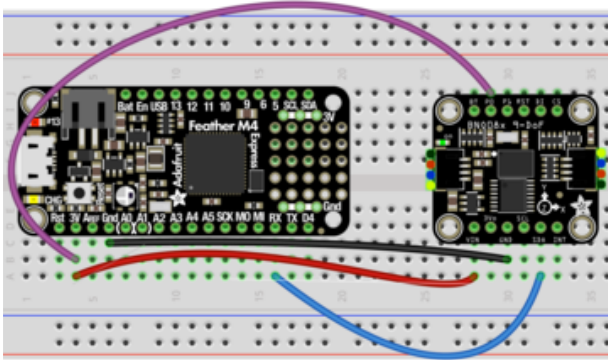

- Feather 3V to BNO085 Vin (Red Wire).
- Device GND to BNO085 GND (Black Wire)
- Device RX to BNO085 SDA (Blue Wire)
- Feather 3V to BNO085 P0 (Purple Wire).

Raspberry Pi Wiring

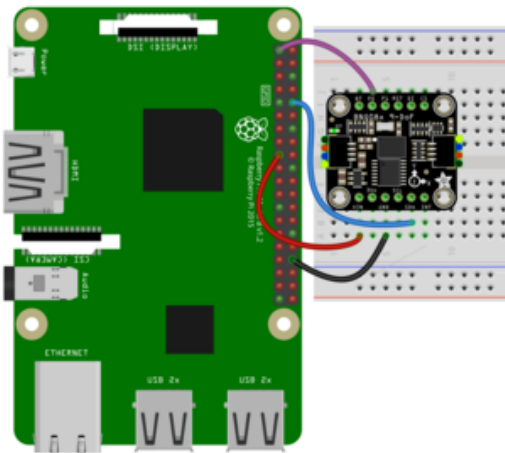

- RPi 3V to BNO085 Vin (Red Wire).
- RPi GND to BNO085 GND (Black Wire)
- RPi RX to BNO085 SDA (Blue Wire)
- RPi 3V to BNO085 P0 (Purple Wire)

For an even simpler hardware setup, bridge the P0 solder jumper on the back of the board to keep it configured in UART-RVC mode. You can always remove the solder to use other modes!

CircuitPython Installation of BNO08x_RVC Library

You'll need to install the [Adafruit CircuitPython BNO08x RVC \(https://adafru.it/O0a\)](https://adafru.it/O0a) library on your CircuitPython board.

Follow the instructions on the [Python & CircuitPython page \(https://adafru.it/O0b\)](https://adafru.it/O0b) for installing CircuitPython and downloading the library bundle

Before continuing make sure your board's lib folder or root filesystem has the adafruit_BNO08x_RVC.mpy file copied over.

Python Installation of BNO08x RVC Library

Follow the instructions on the [Python & CircuitPython page \(https://adafru.it/O0b\)](https://adafru.it/O0b) to set up your Raspberry Pi or other SBC and once that's done, from your command line run the following command:

- `sudo pip3 install adafruit-circuitpython-bno08x-rvc`

If your default Python is version 3 you may need to run 'pip' instead. Just make sure you aren't trying to use CircuitPython on Python 2.x, it isn't supported!

CircuitPython & Python Usage

The following code will walk you through a basic test of the UART RVC mode in the Python REPL

To demonstrate the usage of the sensor setup a UART connection and then we'll initialize the sensor and read the heading and acceleration information from within the board's REPL.

For CircuitPython [connect to the board's serial REPL \(https://adafru.it/Awz\)](https://adafru.it/Awz) so you are at the CircuitPython >>> prompt. For Python, just type ``python`` or ``python3`` to enter the REPL

UART Initialization - CircuitPython

If you are using the UART connection with a board (like a Feather) running CircuitPython, create your uart object as follows:

```
import board
import busio
from adafruit_bno08x_rvc import BNO08x_RVC

uart = busio.UART(board.TX, board.RX, baudrate=115200, receiver_buffer_size=2048)
```

```
>>> import board
>>> import busio
>>> from adafruit_bno08x_rvc import BNO08x_RVC
>>>
>>> uart = busio.UART(board.TX, board.RX, baudrate=115200, receiver_buffer_size=2048)
```

UART Initialization - Python

Check how your specific board supports UART and where the port entry is created and named. For the Raspberry Pi, this is done using the `pyserial` module and the UART used is `/dev/serial0`. Then you create your sensor object as follows:

```
import serial
uart = serial.Serial("/dev/serial0", 115200)
```

```
Python 3.7.7 (default, Jun 5 2020, 12:43:51)
[GCC 8.3.0] on linux
Type "help", "copyright", "credits" or "license" for more information.
>>> import serial
>>> uart = serial.Serial("/dev/serial0", 115200)
```

BNO08x_RVC creation and usage

Now you're ready to create a `BNO08x_RVC` instance with your UART object and use it to read the heading and acceleration value using the `heading` property:

```
from adafruit_bno08x_rvc import BNO08x_RVC
rvc = BNO08x_RVC(uart)

yaw, pitch, roll, x_accel, y_accel, z_accel = rvc.heading
print("Yaw: %2.2f Pitch: %2.2f Roll: %2.2f Degrees" % (yaw, pitch, roll))
print("Acceleration X: %2.2f Y: %2.2f Z: %2.2f m/s^2" % (x_accel, y_accel, z_accel))
```

```
>>> from adafruit_bno08x_rvc import BNO08x_RVC
>>> rvc = BNO08x_RVC(uart)
>>>
>>> yaw, pitch, roll, x_accel, y_accel, z_accel = rvc.heading
>>> print("Yaw: %2.2f Pitch: %2.2f Roll: %2.2f Degrees" % (yaw, pitch, roll))
Yaw: 0.25 Pitch: -5.74 Roll: -4.90 Degrees
>>> print("Acceleration X: %2.2f Y: %2.2f Z: %2.2f m/s^2" % (x_accel, y_accel, z_accel))
Acceleration X: 0.67 Y: -0.77 Z: 7.53 m/s^2
```

Example Code

```
# SPDX-FileCopyrightText: 2020 Bryan Siepert, written for Adafruit Industries
#
# SPDX-License-Identifier: Unlicense
import time
import board
import busio

uart = busio.UART(board.TX, board.RX, baudrate=115200, receiver_buffer_size=2048)

# uncomment and comment out the above for use with Raspberry Pi
# import serial
# uart = serial.Serial("/dev/serial0", 115200)

# for a USB Serial cable:
# import serial
# uart = serial.Serial("/dev/ttyUSB0", baudrate=115200)
```

```
from adafruit_bno08x_rvc import BNO08x_RVC # pylint:disable=wrong-import-position
rvc = BNO08x_RVC(uart)

while True:
    yaw, pitch, roll, x_accel, y_accel, z_accel = rvc.heading
    print("Yaw: %2.2f Pitch: %2.2f Roll: %2.2f Degrees" % (yaw, pitch, roll))
    print("Acceleration X: %2.2f Y: %2.2f Z: %2.2f m/s^2" % (x_accel, y_accel,
z_accel))
    print("")
    time.sleep(0.1)
```

Python Docs

[Python Docs \(https://adafru.it/Nsb\)](https://adafru.it/Nsb)

Python UART RVC Docs

[Python UART RVC Docs \(https://adafru.it/NxE\)](https://adafru.it/NxE)

Report Types

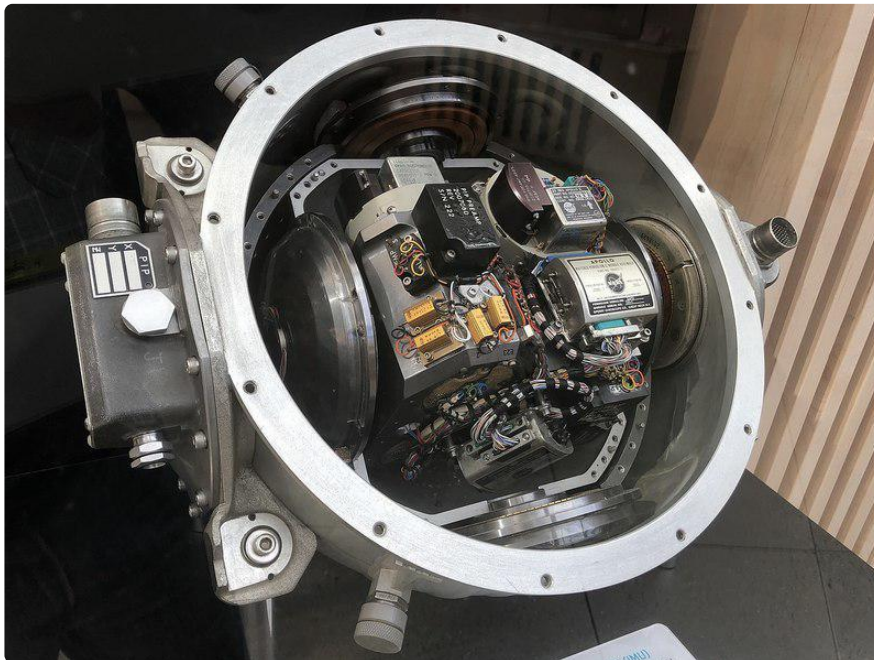

The BNO085 offers many different reports of sensor and classification data as listed below. Multiple reports can be enabled at the same time, allowing you to compare different results or to provide additional data for your application.

Motion Vectors

These reports return calibrated X, Y, and Z axis measurements for the given sensor measurement type.

- Acceleration Vector / Accelerometer
Three axes of acceleration from gravity and linear motion, in m/s^2
- Angular Velocity Vector / Gyro
Three axes of rotational speed in radians per second
- Magnetic Field Strength Vector / Magnetometer
Three axes of magnetic field sensing in micro Teslas (μT)
- Linear Acceleration Vector
Three axes of linear acceleration data with the acceleration from gravity, in m/s^2

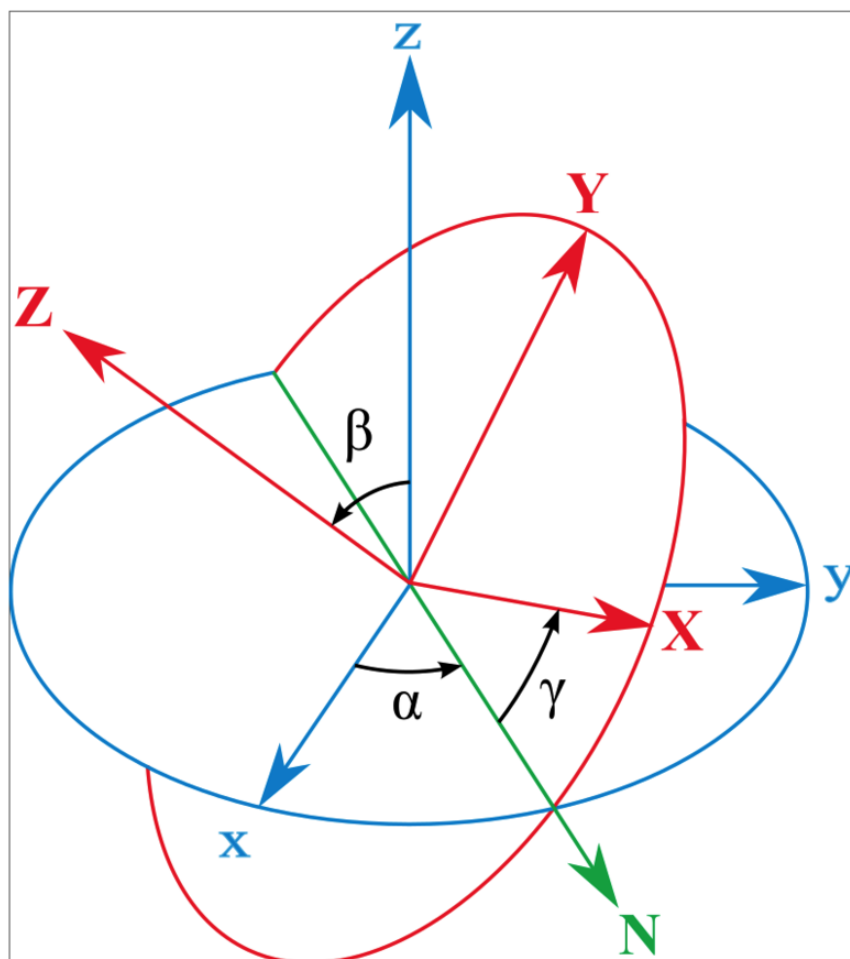

Rotation Vectors

These reports are generated by the BNO085's sensor fusion firmware based on the combination of multiple three-axis motion vectors and are each optimized for different use cases

- Absolute Orientation/ Rotation Vector - Quaternion
Optimized for accuracy and referenced to magnetic north and gravity from accelerometer, gyro, and magnetometer data. The data is presented as a four point quaternion output for accurate data manipulation
- Geomagnetic Rotation Vector - Quaternion
Optimized for low power by fusing the accelerometer and magnetometer only, at the cost of responsiveness and accuracy
- Game Rotation Vector - Quaternion
Optimized for a smoother gaming experience, fused from the accelerometer and gyro without the magnetometer to avoid sudden jumps in the output from magnetometer based corrections

Classification Reports

Using its sensor fusion products, the BNO085 can attempt to classify and detect different types of motion it measures. These are pretty neat and work very well when compared similar features found in other 3 or 6-axis motion sensors

- Stability Classification
Uses the accelerometer and gyro to classify the detected motion as "On table", "Stable", or "Motion"
- Step Counter
Based on the data from the step detector, the sensor tracks the number of steps taken, possibly reclassifying previous events based on the patterns detected.
- Activity Classification
Classifies the detected motion as one of several activity types, providing a most likely classification along with confidence levels for the most likely and other motion types.
- Shake Detector
Detects if the sensor has been shaken

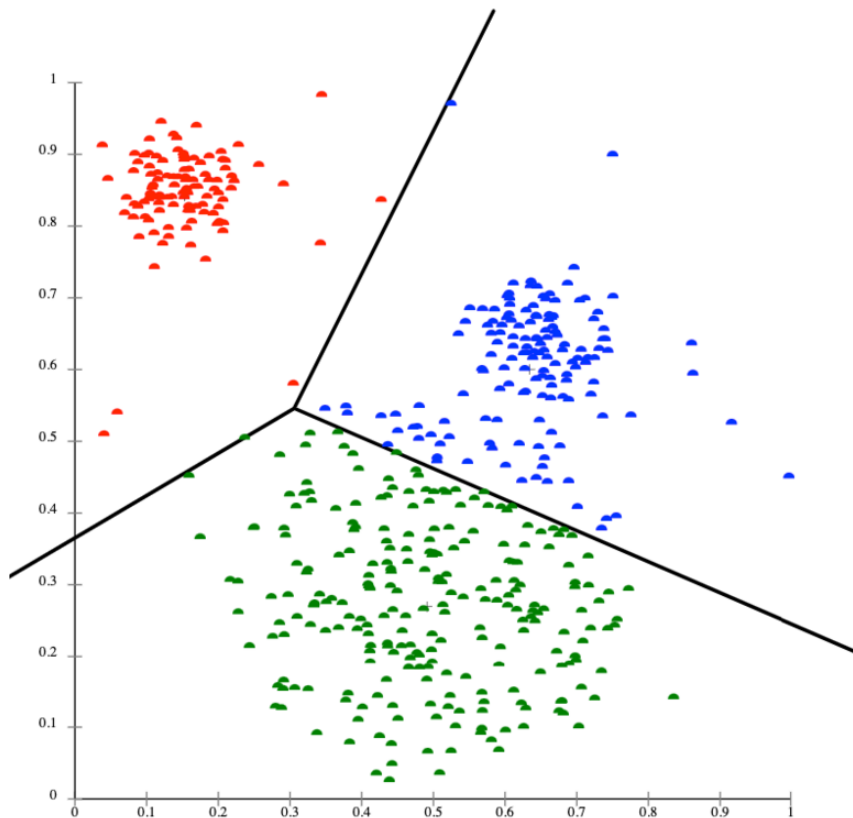

Other Motion Reports

The BNO085 also provides raw ADC readings as well as uncorrected measurements for the accelerometer, gyro, and magnetometer.

- Raw Accelerometer
Unscaled direct ADC readings
- Uncalibrated Gyroscope
Angular velocity without bias compensation, with bias separated
- Raw Gyroscope
Unscaled direct ADC readings
- Uncalibrated Magnetometer
Magnetic field measurements without hard iron offset, offset supplied separately
- Raw Magnetometer
Unscaled direct ADC readings

Additional Reports

There are more (less popular) reports that we don't support at this time, a PR to the libraries is welcome for folks who can implement and test them

- Gravity Vector
- AR/VR stabilized Rotation Vector
- AR/VR stabilized Game rotation vector
- Gyro rotation Vector
- Gyro rotation Vector Prediction
- Significant Motion Detector
- Stability Detection
- Tap Detector
- Step Detector

Downloads

Files

- [BNO08x Datasheet \(https://adafru.it/O0c\)](https://adafru.it/O0c)
- [EagleCAD files on GitHub \(https://adafru.it/O0d\)](https://adafru.it/O0d)
- [Fritzing object in the Adafruit Fritzing Library \(https://adafru.it/O0e\)](https://adafru.it/O0e)

Schematic

