

4803, Socket, PCB terminals, screened, 6.3 mm, 3-pole, straight, UK-Connector

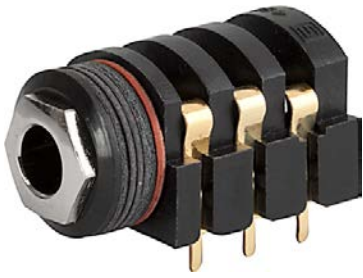

### Description

- PCB Mounting :  
Screw-on mounting , from rear-side
- Data and Signal transfer
- Data and Signal Connectors 3-pole , shielded , straight
- Reinforced gold plating for increased insertions

### References

Alternative: Housing insulated [4803.2330](#)  
Last order date: 30.06.2016

### Technical Data

Diameter	6.3 mm
Number of Poles	3-pole
Ratings DC	2A / 12VDC
Ratings AC	2A / 12VAC
Dielectric Strength	1000VDC
Insulation Resistance	> 10000 MΩ @ 500VDC

Allowable Operation Temp.	-20 °C to 70 °C
Terminal	PCB terminals
Mounting	Screw-on mounting wall thickness max. 5.0mm
Housings	screened
Style	straight
Lifetime	10000 Insertions

### Dimensions

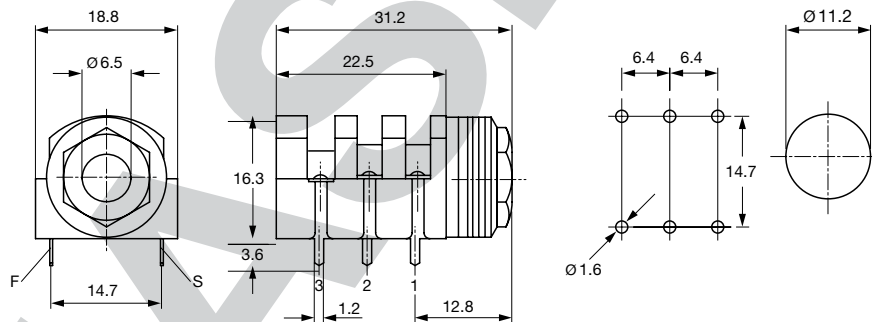

### Diagrams

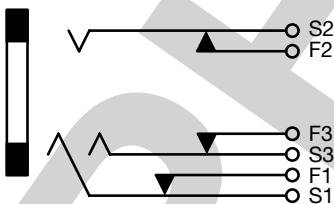

**All Variants**

Product group	Diameter [mm]	Number of Poles	Terminal	Order Number
Data and Signal Plug/ Sockets	6.3	3-pole	PCB terminals	4803.2320

Availability for all products can be searched real-time:<http://www.schurter.com/Stock-Check/Stock-Check-SCHURTER>

<b>Packaging unit</b>	100 Pcs
-----------------------	---------

PHASE-OUT