

THIS DOCUMENT IS THE PROPERTY OF  
KEYSTONE ELECTRONICS CORP. AND  
SHALL NOT BE REPRODUCED, DISTRIBUTED  
OR USED AS A BASIS FOR MANUFACTURE  
WITHOUT PRIOR WRITTEN PERMISSION  
FROM KEYSTONE ELECTRONICS CORP.

**ACTUAL SIZE**

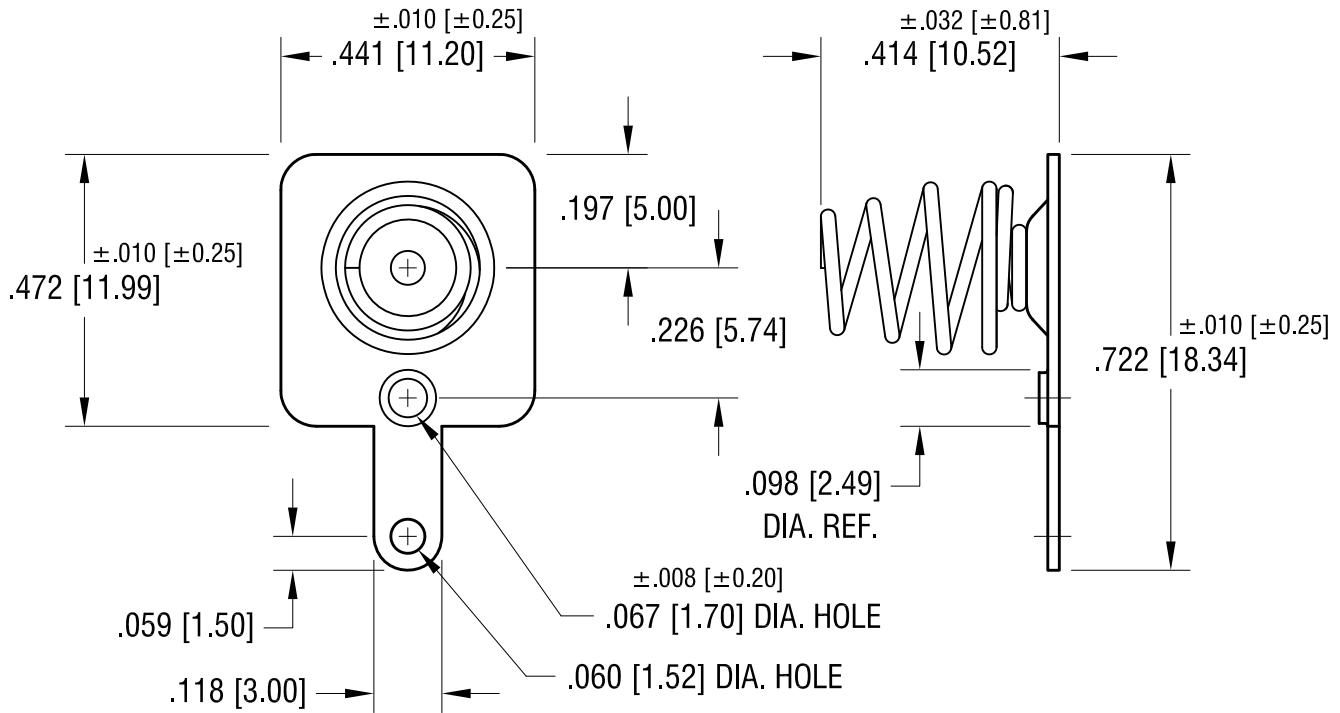

**NOTES:**

**1. BASE:**

MAT'L - .020 [0.50] TH'K STEEL

**SPRING CONTACT:**

MAT'L - .023 [0.58] DIA. MUSIC WIRE

10.16.15	CHANGE AS PER ECN15-119	B
7.8.05	CHANGE AS PER ECN 05-046	A
DATE	DESCRIPTION	REV.

<b>KEYSTONE ELECTRONICS CORP.</b>			
www.keyelco.com • ASTORIA, N.Y. 11105-2017 • Tel (718) 956-8900			
PART NAME			
'AA' FEMALE BATTERY CONTACT			
MATERIAL			
AS NOTED			
FINISH		DRN BY	DATE
NICKEL PLATE		BOONE	2.26.96
		APP'D	SCALE
		LN	3X
TOLERANCES	INCH [MM]	CODE	DWG NO.
DECIMAL	$\pm .005$ [ $\pm 0.13$ ]	C	<b>5201</b>
ANGULAR	$\pm 1^\circ$		
UNLESS OTHERWISE SPECIFIED			