

ASSEMBLY NUMBER	LED COLOR	DIM. "A"	DIM. "B"	DIM. "C"	LUM. INT. (MIN.)(mcd)	V <sub>F</sub> (MAX.) (V)	I <sub>F</sub> (MAX.) (mA)	λ <sub>PEAK</sub> (nm)	TEST. COND.	I <sub>F</sub> (MAX) • 5V(μA)
550-0205F	GREEN DIFFUSED	.135	.020	.043	3.5	2.8		565	20mA	100
550-0305F	YELLOW DIFFUSED	.135	.020	.043	3.5	2.8		585	20mA	100
550-0405F	RED DIFFUSED	.135	.020	.043	3.5	2.8		635	20mA	100
550-0505F	RED DIFFUSED 5 VOLT	.197	.025	.050	2.1		15	635	5V	100
550-0605F	RED DIFFUSED 12 VOLT	.197	.025	.050	1.0		20	655	12V	100
550-0705F	GREEN DIFFUSED 5 VOLT	.197	.025	.050	2.0		15	565	5V	100
550-0805F	YELLOW DIFFUSED 5 VOLT	.197	.025	.050	2.0		15	583	5V	100
550-1005F	BLUE NON-DIFF. WATER CLEAR	.193	.020	.043	520	4.0		470	20mA	100
550-1105F	RED TINTED DIFFUSED 2mA	.197	.018	.040	1.2	2.2		635	2mA	50
550-1205F	YELLOW TINTED DIFFUSED 2mA	.197	.018	.040	2.2	2.7		583	2mA	50
550-1305F	GREEN DIFFUSED 2mA	.197	.018	.040	2.2	2.2		565	2mA	50
550-2205F	GREEN DIFFUSED	.190	.020	.043	3.6	3.0		563	10mA	
550-2305F	YELLOW DIFFUSED	.190	.020	.043	5.7	2.4		583	10mA	100
550-2405F	RED DIFFUSED	.190	.020	.043	2.2	2.55		650	10mA	100
550-2505F	ORANGE DIFFUSED	.197	.018	.040	4.0	2.4		600	10mA	100
550-3005F	RED/GREEN BI-COLOR	.190	.020	.043	14/9	2.4/2.8		660/565	20mA	100
550-3105F	YEL/GREEN BI-COLOR	.190	.020	.043	2.5	2.8		585/565	20mA	100
550-5105F	RED DIFFUSED	.190	.020	.043	17	2.55		650	20mA	10
550-5205F	GREEN TINTED DIFFUSED	.190	.020	.043	17	3.0		563	20mA	10
550-5305F	YELLOW TINTED DIFFUSED	.190	.020	.043	17	3.0		585	20mA	10
550-5405F	AMBER TINTED DIFFUSED	.190	.020	.043	17	3.0		610	20mA	10
550-5505F	RED NON-DIFF. WATER CLEAR	.197	.018	.040	80	3.0		635	20mA	100
550-5605F	GREEN NON-DIFF. WATER CLEAR	.197	.018	.040	80	3.0		585	20mA	100
550-5705F	YELLOW NON-DIFF. WATER CLEAR	.197	.018	.040	80	3.0		583	20mA	100
550-5805F	AMBER NON-DIFF. WATER CLEAR	.190	.024	.050	60	2.5		605	20mA	
550-5905F	GREEN (InGaN) NON-DIFF. WATER CLEAR	.190	.020	.043	2500	4.3		518	20mA	100
550-6005F	WHITE NON-DIFF. WATER CLEAR	.193	.020	.043	880	4.0		SEE CHROMATICITY CHART		

• SEE NOTE 4

• SEE NOTE 4

BIN	LIMITS (CHROMATICITY COORDINATES)				
	X	Y	Z	U	V
1	X	0.330	0.330	0.356	0.361
	Y	0.360	0.318	0.351	0.385
2	X	0.287	0.296	0.330	0.330
	Y	0.295	0.276	0.318	0.339
3	X	0.264	0.280	0.296	0.283
	Y	0.267	0.248	0.276	0.305
4	X	0.283	0.287	0.330	0.330
	Y	0.305	0.295	0.339	0.360

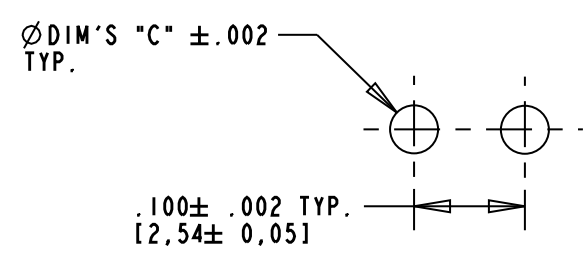
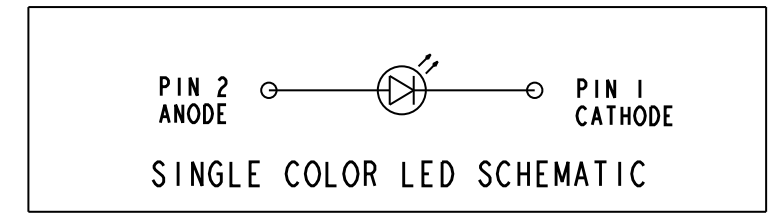
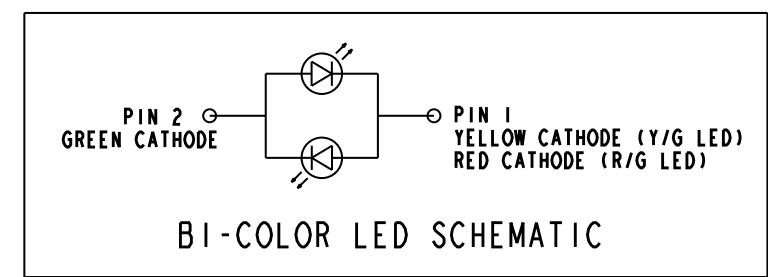
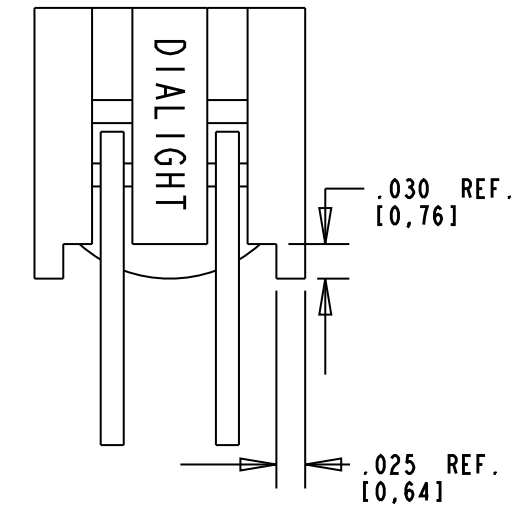
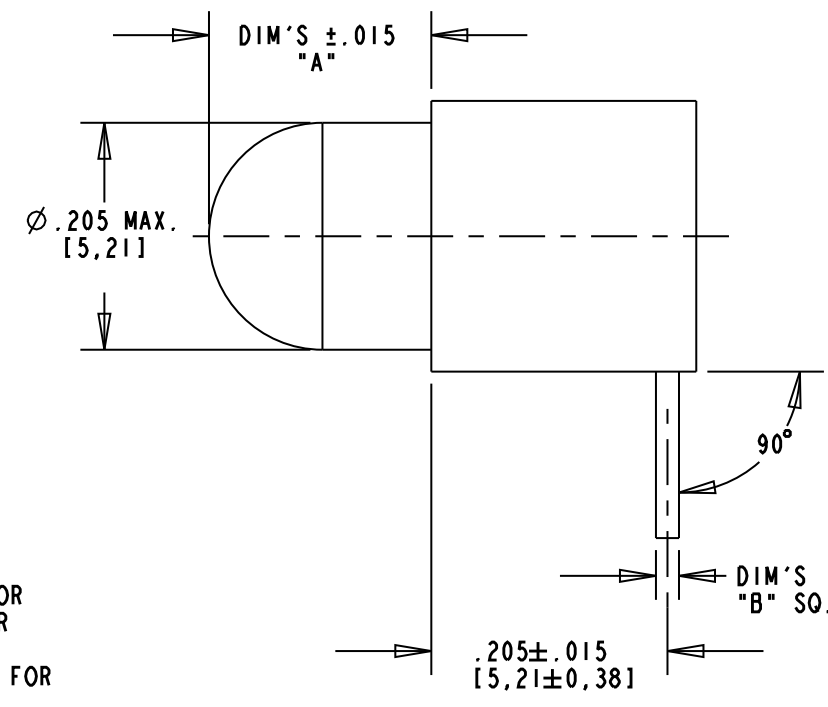
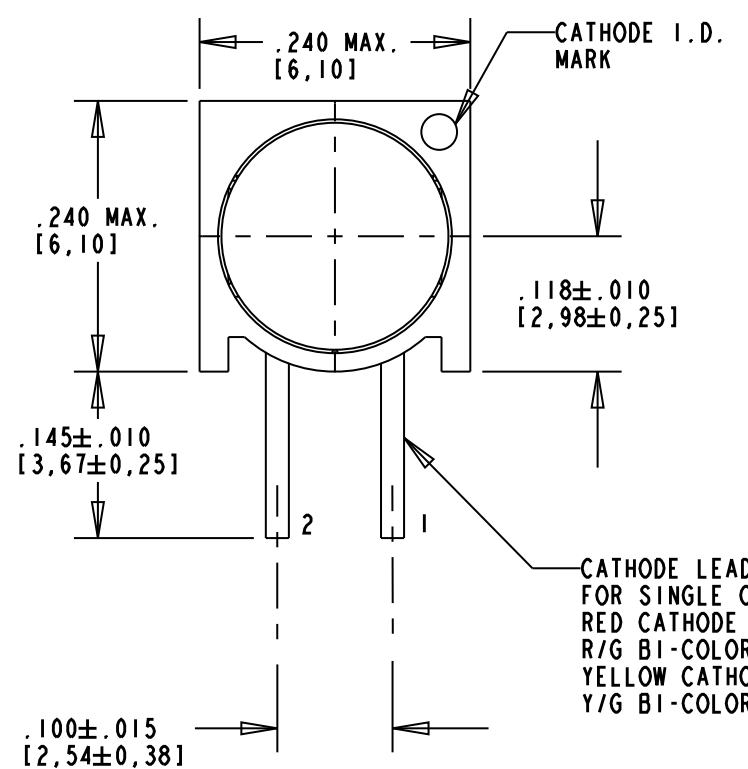
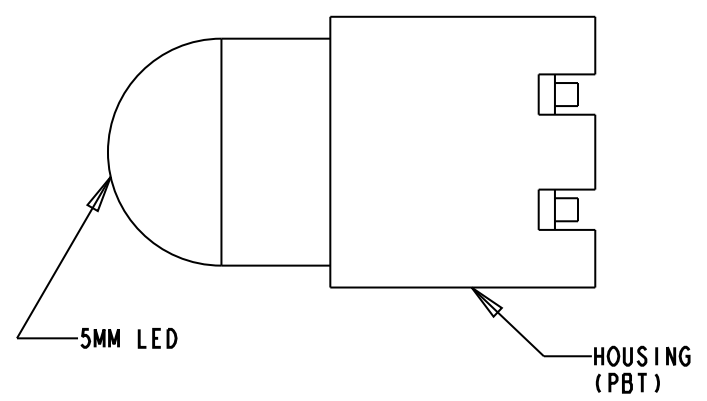

RECOMMENDED P.C.B. HOLE PATTERN

NOTES:

- LEADS TO FIT INTO HOLE PATTERN AS SHOWN.
- LED LEAD DIMENSIONS SHOWN ARE MEASURED AT HOUSING EXIT.
- PIN NUMBERS FOR REFERENCE ONLY, DESIGNATION NON-EXISTENT ON PARTS.
- THIS ASSEMBLY CONTAINS ELECTROSTATIC SENSITIVE DEVICES (ESDS). MAINTAIN ALL PRECAUTIONARY MEASURES DURING ASSEMBLY, HANDLING AND STORAGE IN ACCORDANCE WITH IPC-A-610.
- DIALIGHT PART NUMBER: 550-XX05F.

REV	ECN NO	REVISIONS	DRN	CKD	APP	DATE
A		NEW RELEASE	TWC	TC	N.O.	7-11-05
B		P/N 550-0205F PEAK WAVELENGTH "565" WAS "560".	KLJ	MES	N.O.	4-16-08
C		UPDATED FOLLOWING SPECIFICATIONS FOR 550-0505F: MIN LUM INT "2.1" WAS "1.0"; MAX IF "15" WAS "20"; PEAK WAVELENGTH "635" WAS "655".	KLJ	NO	MES	5-2-08
D		UPDATED FOLLOWING SPECIFICATIONS FOR 550-5905F: DIM A ".190" WAS ".193"; MIN LUM INT "2500" WAS "1900"; MAX VF "4.3" WAS "4.0"; PEAK WAVELENGTH "518" WAS "524".	AJF	KLJ	NO	6-25-09

RoHS Compliant 550-xx05F Thru Hole Single Square Back CBI

Part Numbers with the "F" suffix ending are RoHS Compliant. Example: 550-0205F or any 550-XX05F. The bag packaging is marked with "RoHS Compliant" label or equivalent markings. Parts can be wave soldered, dip soldered or hand soldered using typical lead-free soldering process with max 260°C temp. for 5 sec.



ATTENTION: OBSERVE PRECAUTIONS FOR HANDLING ELECTROSTATIC SENSITIVE DEVICES

THIS DRAWING AND THE CONTENTS HEREIN ARE CONFIDENTIAL AND THE SOLE PROPERTY OF DIALIGHT. REPRODUCTION OF THIS DRAWING OR CONSTRUCTION OF ANY PARTS WITHIN THIS DRAWING ARE FORBIDDEN WITHOUT THE WRITTEN CONSENT OF DIALIGHT.		
SCALE: 6.000	DRAWING NUMBER	REV
ALL DIM'S IN: INCHES (MM)	C-17264	D
TOLERANCES: UNLESS OTHERWISE SPECIFIED	TITLE 5mm LED CBI, SQ. BACK HOUSING	
FRACTIONS: ±1/64	RoHS COMPLIANT	
DECIMALS (.XX): ±.01	MATERIAL	
DECIMALS (.XXX): ±.005	FINISH:	
DECIMALS (.XXXX): ±.0005	Dialight	
ANGLES: ±1°	1501 ROUTE 34 SOUTH	
	FARMINGDALE, NJ 07727	
FSCM 83330	SHEET 1 OF 1	FAMILY TABLES: