

Fair-Rite Products Corp.

Ferrite Components for the Electronics Industry



®



17th Edition

Your Signal Solution®

Our Position on Quality And the Environment

Fair-Rite Products Corp. is committed to be "Your Signal Solution". Management and employees continue to adhere to the ISO/TS 16949 quality system, in effect at the time of the printing of this catalog revision, providing continual improvement towards defect prevention, variation reduction and customer satisfaction. We are committed to offering high quality products and services while maintaining an environmentally friendly and sustainable manufacturing process. As a responsible member of the corporate and local community, Fair-Rite continues to stay proactive in compliance with local, national and international environmental regulations regarding manufacturing, emissions and documentation.

Modern value enhancement tools, including Control Plans, Advanced Product Quality Planning (APQP), Production Part Approval Process (PPAP), Failure Mode and Effects Analysis (FMEA) and Feasibility Assessments, are available for the quality planning process. Contract review, design control, and the purchasing function all meet the requirements of ISO/TS 16949. Process and product control, including measurement, traceability, handling and delivery, meet the highest quality standards. Any nonconforming or suspect product is tracked. Corrective and preventive actions, statistical methods, and internal audits are applied to guarantee continual improvement. Extensive training is provided to all employees to support the system. Product inspection, tests and records verify that specified requirements are met. Critical characteristics are monitored by statistical methods, including pre-control, control charts, and SPC. Process capability indices, Cpk's, are targeted to exceed 1.33 for these critical characteristics. When sampling plans are employed, zero defects are allowed in any sample. Visual inspection criteria for chips, cracks and surface finish are documented. IEC Standard 60424 is used as a guide for evaluation of visual imperfections. For product types not defined by IEC Standard 60424, customer specific, or Fair-Rite's visual inspection criteria shall apply.

All Fair-Rite Products Corp. components are RoHS and REACH compliant per the thresholds in effect at the time of the printing of this catalog revision. Termination wire used on all board level components and the plated contacts on chip components have 100% matte tin plating over a nickel undercoating. The polypropylene cases used to assemble Fair-Rite "Snap-It" cores do not contain PBB or PBDE as a flame retardant.

Fair-Rite Products Corp. adheres to the practice of continual improvement. Therefore, in order to offer our customers optimized designs, the company reserves the right to change materials, designs, dimensions, etc. at any time without notice.

Table of Contents

Our Position on Quality and the Environment	I.F.C
Introduction	2
Magnetic Properties of Fair-Rite Materials	4
Fair-Rite Materials	8
Board Components	
Solder Profile	34
EMI Suppression Beads	35
Beads on Leads	39
PC Beads (Through Hole)	42
Wound Beads	44
Multi-Aperture Cores	47
SM Beads (Differential-Mode)	50
SM Beads (Common-Mode)	55
Chip Beads	58
Chip Arrays	64
Engineering Kits	
Cable Components	
Round Cable EMI Suppression Cores	75
Round Cable Snap-Its	80
Flat Cable EMI Suppression Cores	84
Flat Cable Cores Assembly Clips	87
Flat Cable Snap-Its	88
Connector EMI Suppression Plates	89
Miscellaneous Suppression Cores	91
Inductive Components	
Open Magnetic Circuit	
Rods	93
Rod Information	95
Antenna/RFID Rods	97
Bobbins	99
Closed Magnetic Circuit	
Toroids	102
Planar Cores	111
Pot Cores	114
RM Cores	116
PQ Cores	118
E Cores	120
EFD Cores	122
ETD Cores	124
EER Cores	126
U Cores	128
EP Cores	130
Product Capability	132
References	
Reference Tables	134
Glossary of Terms	135
Soft Ferrite References	136
Magnetic Design Formulas	138
Wire Table of Copper Magnet Wire	139
Technical Articles	
Use of Ferrites in Broadband Transformers	140
How to Choose Ferrite Components for EMI Suppression	144
Part Number Index	154

Copyright © 2013 by Fair-Rite Products Corp.

All rights reserved. No part of the contents of this book may be published or transmitted in any form or by any means without the expressed written permission of Fair-Rite Products Corp.

Fair-Rite Products Corp. PO Box 288, One Commercial Row, Wallkill, NY 12589-0288

Phone: (888) FAIR RITE / (845) 895-2055 • Fax: (888) FERRITE / (845) 895-2629 • Web: www.fair-rite.com
 (888) 324-7748 (888) 337-7483 E-mail: ferrites@fair-rite.com

Introduction

History

The history of magnetism began with the discovery of the properties of a mineral called magnetite (Fe_3O_4). The most plentiful deposits were found in the district of Magnesia in Asia Minor (hence the mineral's name) where it was observed, centuries before the birth of Christ, that these naturally occurring stones would attract iron. Later on it found application in the lodestone of early navigators. In 1600 William Gilbert published *De Magnete*, the first scientific study on magnetism. In 1819 Hans Christian Oersted observed that an electric current in a wire affected a magnetic compass needle, thus with later contributions by Faraday, Maxwell, Hertz and others, the new science of electromagnetism came into being.

Even though the existence of naturally occurring magnetite, a weak type of hard ferrite, had been known since antiquity, producing an analogous soft magnetic material in the laboratory proved elusive. Research on magnetic oxides was going on concurrently during the 1930's, primarily in Japan and The Netherlands. However, it was not until 1945 that J. L. Snoek of the Philips' Research Laboratories in The Netherlands succeeded in producing a soft ferrite material for commercial applications.

Fair-Rite Products Corp. was not far behind in the manufacture and sale of soft ferrites for use in the electronics industry. It was formed in 1952 and officially started operations in 1953. The ensuing years have seen a rather crude product, which was available in only a few shapes and materials, develop into a major line of ferrite components for inductive devices, produced in many core configurations with a wide selection of materials. The application of ferrites in EMI suppression as shield beads and broadband chokes, where an effective resistive impedance is produced at high frequencies, has grown so fast in the last decade, that their use as EMI suppressors is limited only by the imagination of the end user.

Soft Ferrites

The single most important characteristic of soft ferrites, as compared to other magnetic materials, is the high volume resistivity exhibited in the monolithic form. Since eddy current losses are inversely proportional to resistivity and these losses increase with the square of the frequency, high resistivity becomes an essential factor in magnetic materials intended for high frequency operation. The magnetic properties of ferrite components are isotropic, and by employing various pressing, injection molding, and/or grinding techniques, a wide range of complex shapes can be formed. There is no other class of magnetic material that can match soft ferrites in performance, cost and volumetric efficiency, from audio frequencies into the GHz range.

During the last 50 years the basic constituents of ferrites have changed little, but purity of raw materials and process control have improved dramatically. Ferrites are ceramic materials with the general chemical formula $\text{MO}\cdot\text{Fe}_2\text{O}_3$, where MO is one or more divalent metal oxides blended with 48 to 60 mole percent

of iron oxide. Fair-Rite manufactures four broad groups of soft ferrite materials:

Manganese zinc (Fair-Rite 31, 33, 73, 75, 76, 77, 78, 79, 97, 95 and 98 material)

Nickel zinc (Fair-Rite 43, 44, 51, 52, 61, 67 and 68 material)

Manganese (Fair-Rite 85 material – special order)

Magnesium zinc (Fair-Rite 46 material)

Manganese zinc ferrites are completely vitrified and have very low porosity. They have the highest permeabilities and exhibit volume resistivities ranging from one hundred to several thousand ohm-centimeter. Manganese zinc ferrite components are used in tuned circuits and magnetic power designs from the low kilohertz range into the broadcast spectrum. These ferrites have a linear expansion coefficient of approximately 10 ppm/°C,

The nickel zinc ferrites vary in porosity, and frequently contain oxides of other metals, such as those of magnesium, manganese, copper or cobalt. Volume resistivities range from several kilohm-centimeter to tens of megohm-centimeter. In general, they are used at higher frequencies (above 1 MHz), and are suitable for low flux density applications. Nickel zinc ferrites have a linear expansion coefficient of approximately 8 ppm/°C.

The manganese ferrite is a dense, temperature stable material displaying a high degree of squareness in its hysteresis loop. This makes this material uniquely suited for such applications as multiple output control in switched-mode power supplies and high frequency magnetic amplifiers.

The magnesium zinc ferrite has similar characteristics as NiZn ferrite. The composition of MgZn material does not contain any nickel, hence avoiding potential environmental issues as well as reducing the raw material component cost.

As is evident from the flow diagram on page 3, there is considerable processing involved, and the manufacturing cycle will take a minimum of two weeks. The parts listed in the catalog represent a broad cross section of the wide variety of cores produced by Fair-Rite Products. Large OEM quantities are manufactured by Fair-Rite to order. Most of the more commonly used parts are stocked by our distributors, offering prompt deliveries. For a complete listing of our distributors visit our site on the Internet at www.fair-rite.com.

Many of the parts produced by Fair-Rite are made to customer specifications, and we welcome inquiries involving application specific designs. We have the capability to design tooling rapidly, and have it fabricated either by our own tool shop or by outside vendors.

Footnote: *The difference between hard and soft ferrite is not tactile, but rather a magnetic characteristic.*

Soft ferrite does not retain significant magnetization, whereas hard ferrite magnetization is considered permanent.

Introduction

Simplified Process Flow Diagram

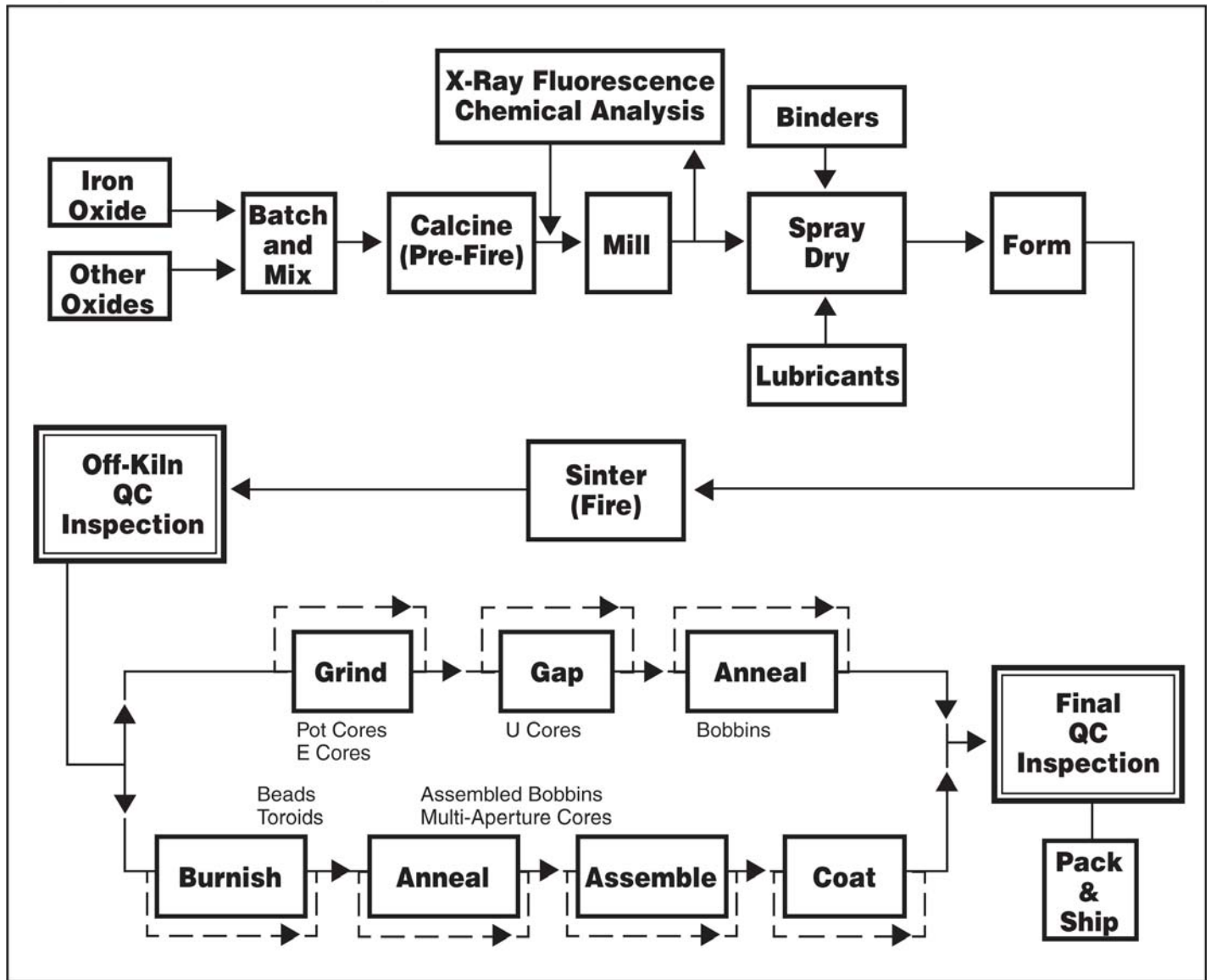

Fair-Rite Products Corp.
 CAGE # 34899
 Federal ID# 141389596

Ferrite Cores
 Standard Industrial Classification (SIC) 3264
 North American Industry
 Classification System (NAICS) 327113

Fair-Rite Products Corp. PO Box 288, One Commercial Row, Wallkill, NY 12589-0288

Phone: (888) FAIR RITE / (845) 895-2055 • Fax: (888) FERRITE / (845) 895-2629 • Web: www.fair-rite.com
 (888) 324-7748 (888) 337-7483 E-mail: ferrites@fair-rite.com

Magnetic Properties of Ferrite Materials

Property	Unit	Symbol	68	67	61	52	51	44
Initial Permeability @ B <10 gauss		μ_i	16	40	125	250	350	500
Flux Density @ Field Strength	gauss	B	2700	2300	2350	4200	3200	3000
	mT		270	230	235	420	320	300
	oersted	H	40	20	15	10	10	10
	A/m		3200	1600	1200	800	800	800
Residual Flux Density	gauss	B_r	1000	800	1200	2900	1200	1100
	mT		100	80	120	290	120	110
Coercive Force	oersted	H_c	7	3.5	1.8	0.6	0.6	0.45
	A/m		560	280	144	48	48	36
Loss Factor @ Frequency	10^{-6}	$\tan \delta/\mu_i$	500	150	30	45	40	125
	MHz		100	50	1	1	1	1
Temperature Coefficient of Initial Permeability (20 - 70°C)	%/°C	T.C.	0.10	0.05	0.10	1.00	0.80	0.75
Curie Temperature	°C	T_c	>500	>475	>300	>250	>170	>160
Resistivity	ohm-cm	ρ	10^7	10^7	10^8	10^9	10^9	10^9
Power Loss Density 25kHz - 2000 G - 100°C 100kHz - 1000 G - 100°C 100kHz - 2000 G - 100°C 500kHz - 500 G - 100°C	mW/cm ³	P	--	--	--	--	--	--
			--	--	--	--	--	--
			--	--	--	--	--	--
			--	--	--	--	--	--
Recommended Frequency Range	MHz							
Application Area	Low flux density devices		<400	<300	<100	<20	--	--
	EMI suppression		--	--	200-2000	200-1000	<200	25-300
	Power magnetics		--	--	--	--	--	--
See this page for additional material data			8	9	10	11	12	13

Magnetic Properties of Ferrite Materials

Property	Unit	Symbol	46	33	43	79	31	77
Initial Permeability @ B <10 gauss		μ_i	500	600	800	1400	1500	2000
Flux Density	gauss	B	3000	2800	2900	4700	3400	4900
	mT		300	280	290	470	340	490
@ Field Strength	oersted	H	10	5	10	5	5	5
	A/m		800	400	800	400	400	400
Residual Flux Density	gauss	B_r	1900	1200	1300	1700	2500	1800
	mT		190	120	130	170	250	180
Coercive Force	oersted	H_c	0.4	0.6	0.45	0.4	0.35	0.3
	A/m		32	48	36	32	28	24
Loss Factor @ Frequency	10^{-6} MHz	$\tan \delta / \mu_i$	60 0.1	25 0.2	250 1	4 0.1	20 0.1	15 0.1
Temperature Coefficient of Initial Permeability (20 - 70°C)	%/°C	T.C.	--	0.10	1.25	0.60	1.60	0.70
Curie Temperature	°C	T_c	>140	>150	>130	>225	>130	>200
Resistivity	ohm-cm	ρ	10^8	100	10^5	200	3000	100
Power Loss Density 25kHz - 2000 G - 100°C	mW/cm ³	P	--	--	--	--	--	200
100kHz - 1000 G - 100°C			--	--	--	--	--	--
100kHz - 2000 G - 100°C			--	--	--	--	--	--
500kHz - 500 G - 100°C			--	--	--	80	--	--
Recommended Frequency Range	MHz							
Application	Low flux density devices		--	<3	<10	--	--	<3
Area	EMI suppression		25-300	--	25-300	--	1-300	--
	Power magnetics		--	--	--	<0.75	--	<0.1
See this page for additional material data			14	15	16	18/19	17	20/21

Magnetic Properties of Ferrite Materials

Property	Unit	Symbol	97	78	98	73	95	75	76
Initial Permeability @ B <10 gauss		μ_i	2000	2300	2400	2500	3000	5000	10000
Flux Density @ Field Strength	gauss	B	5000	4800	5000	3900	5000	4300	4000
	mT		500	480	500	390	500	430	400
	oersted	H	5	5	5	5	5	5	5
	A/m		400	400	400	400	400	400	400
Residual Flux Density	gauss	Br	1500	1500	1800	1500	800	1400	1800
	mT		150	150	180	150	80	140	180
Coercive Force	oersted	Hc	0.16	0.2	0.17	0.24	0.13	0.16	0.12
	A/m		13	16	14	19.2	10	13	9.6
Loss Factor @ Frequency	10^{-6}	$\tan \delta / \mu_i$	3.5	4.5	3.5	10	3	15	15
	MHz		0.1	0.1	0.1	0.1	0.1	0.1	0.025
Temperature Coefficient of Initial Permeability (20 - 70°C)	%/°C	T.C.	1.40	1.00	1.50	0.65	0.40	0.60	0.50
Curie Temperature	°C	Tc	>220	>200	>215	>160	>220	>140	>120
Resistivity	ohm-cm	ρ	200	200	200	100	200	300	50
Power Loss Density 25kHz - 2000 G - 100°C 100kHz - 1000 G - 100°C 100kHz - 2000 G - 100°C 500kHz - 500 G - 100°C	mW/cm ³	P	--	75	--	--	--	140	--
			50	85	50	--	50	--	--
			320	--	310	--	310	--	--
			--	--	--	--	--	--	--
Recommended Frequency Range	MHz								
Application Area	Low flux density devices		--	<2.5	--	--	--	<0.75	<0.5
	EMI suppression		--	--	--	<50	--	<30	--
	Power magnetics		<0.4	<0.2	<0.2	--	<0.2	<0.1	--
See this page for additional material data			22/23	24/25	26/27	28	29/30	31	32

These tables provide an overview of the major magnetic properties of all the Fair-Rite Products Corp. ferrite materials.

Measurements are made at room temperature, unless otherwise specified, using medium size toroidal cores. Products will generally comply with these material properties. However detailed ferrite component specifications are as listed in the catalog or as mutually agreed to with the customer for their specific application.

Fair-Rite Products Corp. PO Box 288, One Commercial Row, Walkill, NY 12589-0288

Phone: (888) FAIR RITE / (845) 895-2055 • Fax: (888) FERRITE / (845) 895-2629 • Web: www.fair-rite.com
(888) 324-7748 (888) 337-7483 E -mail: ferrites@fair-rite.com

For Your Notes

Visit our website at:
www.fair-rite.com

Fair-Rite Products Corp. PO Box 288, One Commercial Row, Wallkill, NY 12589-0288

Phone: (888) FAIR RITE / (845) 895-2055 • Fax: (888) FERRITE / (845) 895-2629 • Web: www.fair-rite.com
(888) 324-7748 (888) 337-7483 E -mail: ferrites@fair-rite.com

Our highest frequency NiZn ferrite intended for broadband transformers, antennas and HF high Q inductor applications up to 100 MHz. This material is only supplied to customer-specific requirements and close consultation with our application staff is suggested.

Strong magnetic fields or excessive mechanical stresses may result in irreversible changes in permeability and losses.

68 Material Characteristics:

Property	Unit	Symbol	Value
Initial Permeability @ B < 10 gauss		μ_i	16
Flux Density @ Field Strength	gauss oersted	B H	2700 40
Residual Flux Density	gauss	B_r	1000
Coercive Force	oersted	H_c	7.0
Loss Factor @ Frequency	10^{-6} MHz	$\tan \delta / \mu_i$	500 100
Temperature Coefficient of Initial Permeability (20 -70°C)	%/°C		0.10
Curie Temperature	°C	T_c	>500
Resistivity	Ω cm	ρ	1×10^7

Complex Permeability vs. Frequency

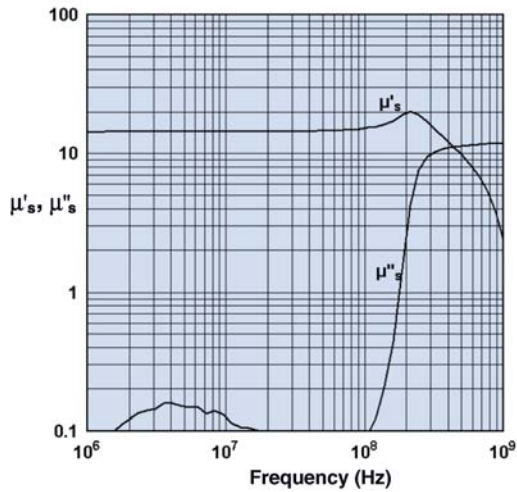

Measured on an 18/10/6mm toroid using the HP 4284A and the HP 4291A.

Initial Permeability vs. Temperature

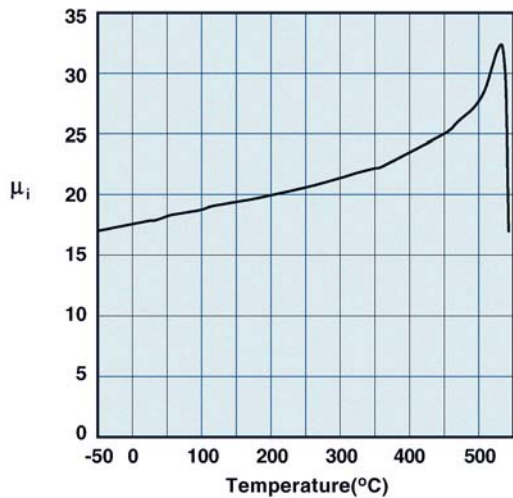

Measured on an 18/10/6mm toroid at 100 kHz.

Hysteresis Loop

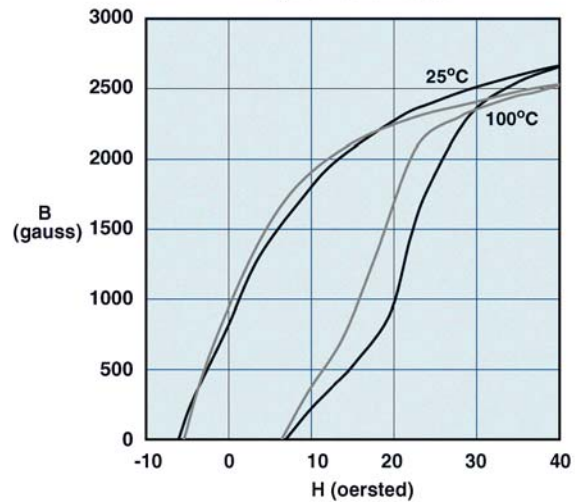

Measured on an 18/10/6mm toroid at 10 kHz.

A high frequency NiZn ferrite for the design of broadband transformers, antennas and HF, high Q inductor applications up to 50 MHz. Toroids, multi-aperture cores and antenna/RFID rods are available in this material.

Strong magnetic fields or excessive mechanical stresses may result in irreversible changes in permeability and losses.

67 Material Characteristics:

Property	Unit	Symbol	Value
Initial Permeability @ B < 10 gauss		μ_i	40
Flux Density @ Field Strength	gauss oersted	B H	2300 20
Residual Flux Density	gauss	B_r	800
Coercive Force	oersted	H_c	3.5
Loss Factor @ Frequency	10^{-6} MHz	$\tan\delta/\mu_i$	150 50
Temperature Coefficient of Initial Permeability (20 -70°C)	%/°C		0.05
Curie Temperature	°C	T_c	>475
Resistivity	Ω cm	ρ	1×10^7

Complex Permeability vs. Frequency

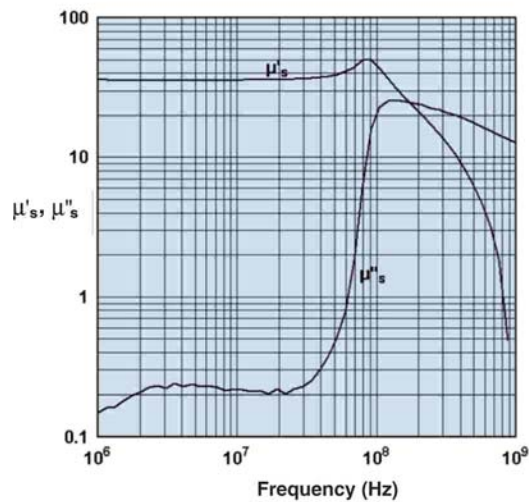

Measured on an 19/10/6mm toroid using the HP 4284A and the HP 4291A.

Initial Permeability vs. Temperature

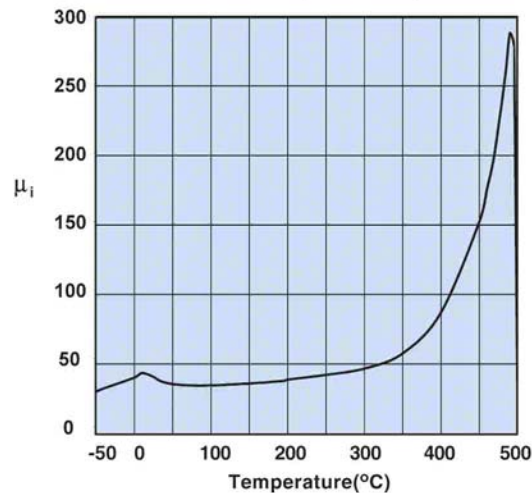

Measured on a 19/10/6mm toroid at 100 kHz.

Hysteresis Loop

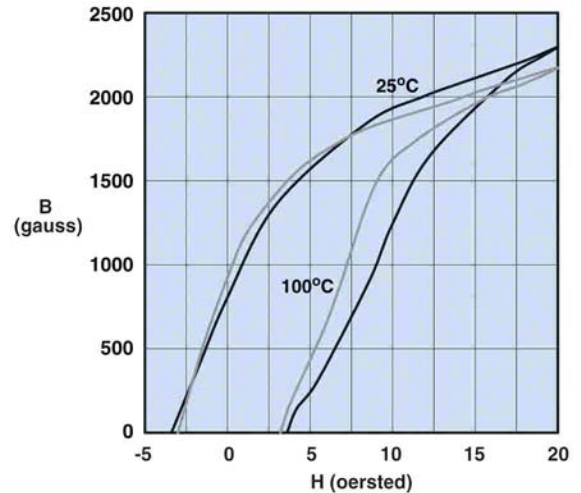

Measured on a 19/10/6mm toroid at 10 kHz.

A high frequency NiZn ferrite developed for a range of inductive applications up to 25 MHz. This material is also used in EMI applications for suppression of noise frequencies above 200 MHz.

EMI suppression beads, beads on leads, SM beads, wound beads, multi-aperture cores, round cable snap-its, rods, antenna/RFID rods, and toroids are all available in 61 material.

Strong magnetic fields or excessive mechanical stresses may result in irreversible changes in permeability and losses.

61 Material Characteristics:

Property	Unit	Symbol	Value
Initial Permeability @ B < 10 gauss		μ_i	125
Flux Density @ Field Strength	gauss oersted	B H	2350 15
Residual Flux Density	gauss	B_r	1200
Coercive Force	oersted	H_c	1.8
Loss Factor @ Frequency	10^{-6} MHz	$\tan \delta / \mu_i$	30 1.0
Temperature Coefficient of Initial Permeability (20 -70°C)	%/°C		0.10
Curie Temperature	°C	T_c	>300
Resistivity	Ω cm	ρ	1×10^8

Complex Permeability vs. Frequency

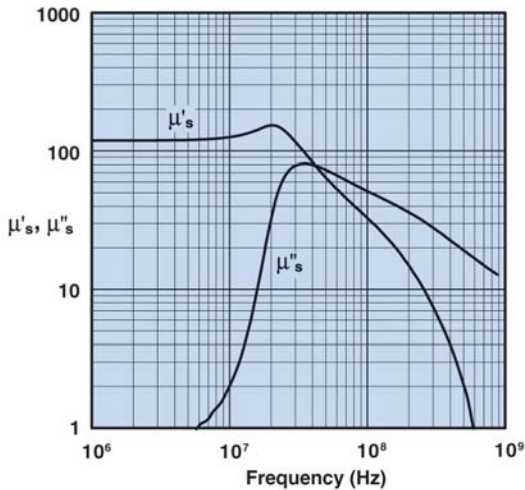

Measured on a 19/10/6mm toroid using the HP 4284A and the HP 4291A.

Percent of Original Impedance vs. Temperature

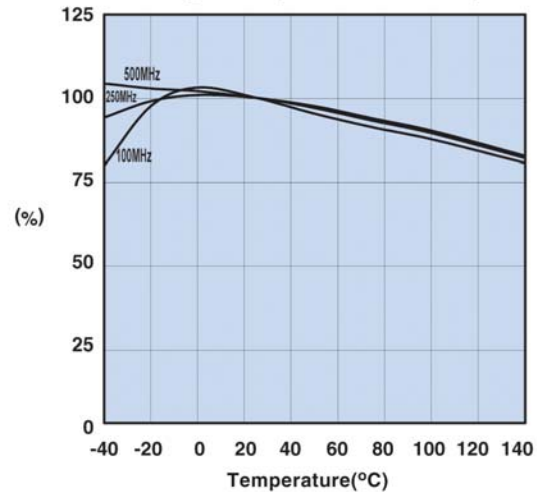

Measured on a 2661000301 using the HP4291A.

Initial Permeability vs. Temperature

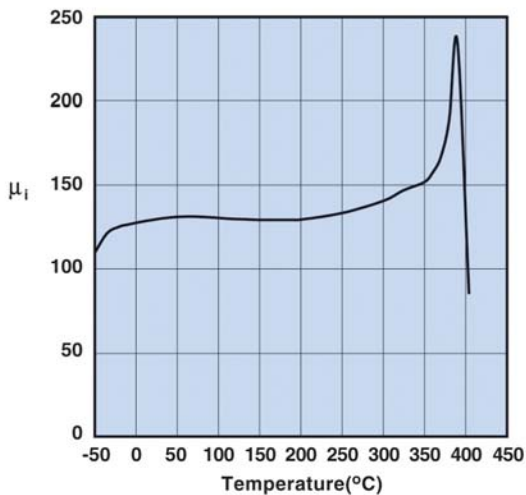

Measured on a 19/10/6mm toroid at 100 kHz.

Hysteresis Loop

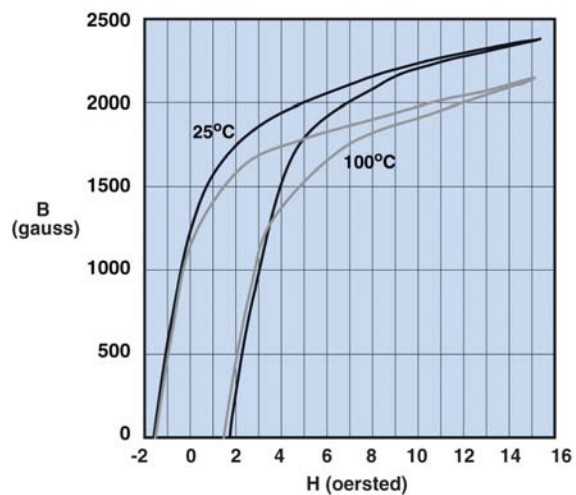

Measured on a 19/10/6mm toroid at 10 kHz.

A new high frequency NiZn ferrite material, that combines a high saturation flux density and a high Curie temperature.

SM beads, PC beads and a range of rod cores are available in this material.

52 Material Specifications:

Property	Unit	Symbol	Value
Initial Permeability @ B < 10 gauss		μ_i	250
Flux Density @ Field Strength	gauss oersted	B H	4200 10
Residual Flux Density	gauss	B_r	2900
Coercive Force	oersted	H_c	0.60
Loss Factor @ Frequency	10^{-6} MHz	$\tan \delta/\mu_i$	45 1.0
Temperature Coefficient of Initial Permeability (20 -70°C)	%/°C		1.0
Curie Temperature	°C	T_c	>250
Resistivity	Ω cm	ρ	1×10^9

Complex Permeability vs. Frequency

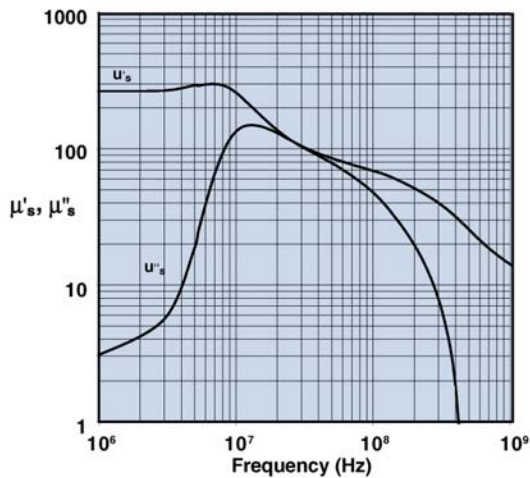

Measured on a 17/10/6mm toroid using the HP 4284A and the HP 4291A.

Flux Density vs. Temperature

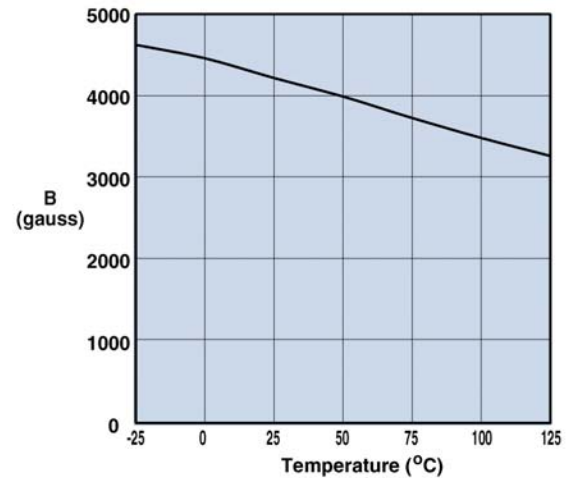

Measured on a 17/10/6mm toroid at 10kHz, and H=10 oersted.

Initial Permeability vs. Temperature

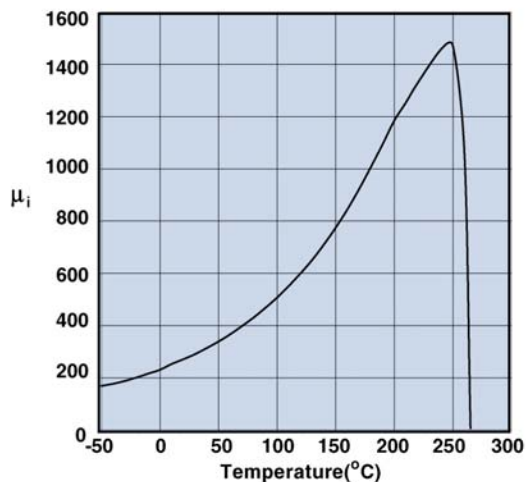

Measured on a 17/10/6mm toroid at 100kHz.

Hysteresis Loop

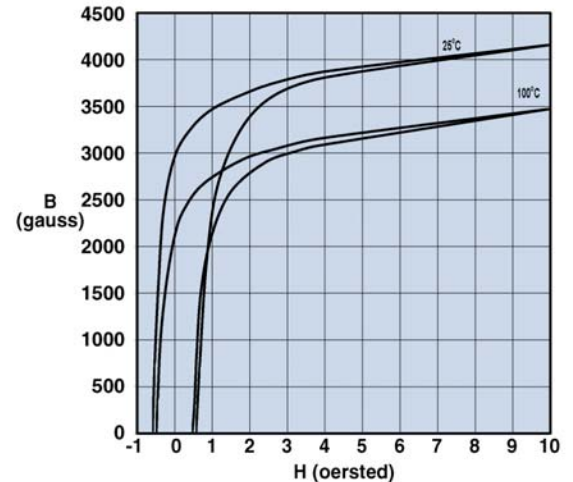

Measured on a 17/10/6mm toroid at 10kHz.

A NiZn ferrite developed for low loss inductive designs for frequencies up to 5.0 MHz.

This material is available as special order for customer specific applications.

51 Material Characteristics:

Property	Unit	Symbol	Value
Initial Permeability @ B < 10 gauss		μ_i	350
Flux Density @ Field Strength	gauss oersted	B H	3200 10
Residual Flux Density	gauss	B_r	1200
Coercive Force	oersted	H_c	0.60
Loss Factor @ Frequency	10^{-6} MHz	$\tan \delta / \mu_i$	40 1.0
Temperature Coefficient of Initial Permeability (20 -70°C)	%/°C		0.8
Curie Temperature	°C	T_c	>170
Resistivity	Ω cm	ρ	1×10^9

Complex Permeability vs. Frequency

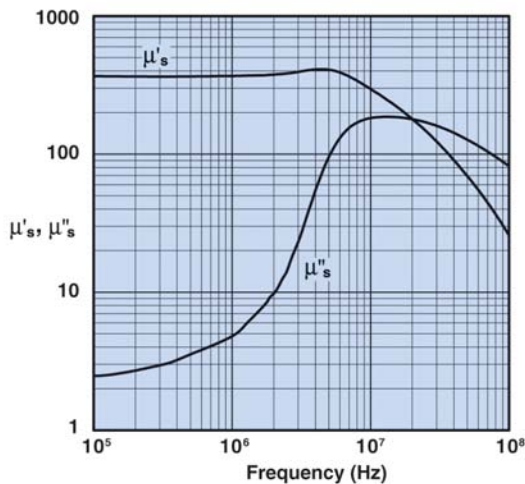

Measured on a 17/10/6mm toroid using the HP 4284A and the HP 4291A.

Incremental Permeability vs. H

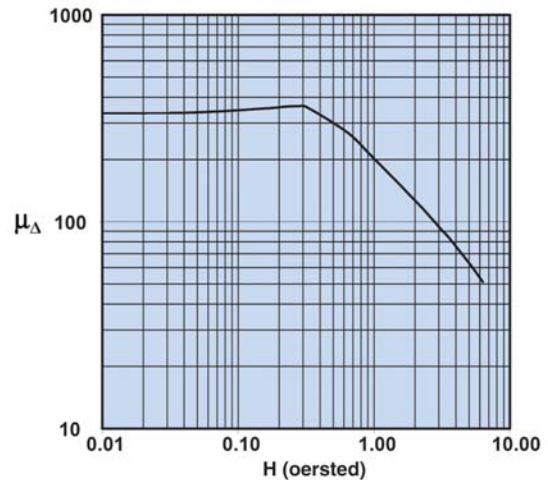

Initial Permeability vs. Temperature

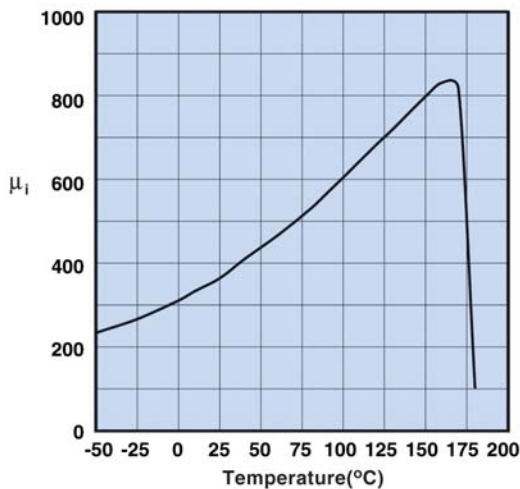

Measured on a 17/10/6mm toroid at 100 kHz.

Hysteresis Loop

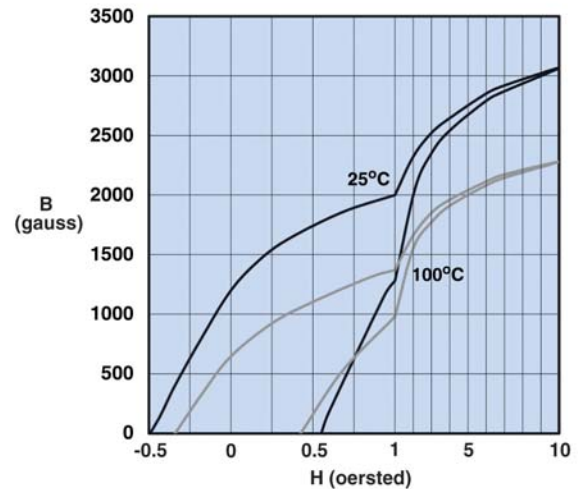

Measured on a 17/10/6mm toroid at 10 kHz.

A NiZn ferrite developed to combine a high suppression performance, from 30 MHz to 500 MHz, with a very high dc resistivity.

SM beads, PC beads, wound beads, round cable snap-its, and connector EMI suppression plates are all available in 44 material.

44 Material Characteristics:

Property	Unit	Symbol	Value
Initial Permeability @ B < 10 gauss		μ_i	500
Flux Density @ Field Strength	gauss oersted	B H	3000 10
Residual Flux Density	gauss	B_r	1100
Coercive Force	oersted	H_c	0.45
Loss Factor @ Frequency	10^{-6} MHz	$\tan \delta / \mu_i$	125 1.0
Temperature Coefficient of Initial Permeability (20 -70°C)	%/°C		0.75
Curie Temperature	°C	T_c	>160
Resistivity	Ω cm	ρ	1×10^9

Complex Permeability vs. Frequency

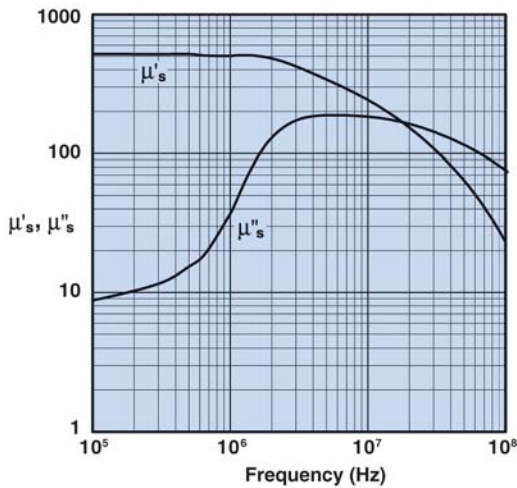

Measured on a 17/10/6mm toroid using the HP 4284A and the HP 4291A.

Percent of Original Impedance vs. Temperature

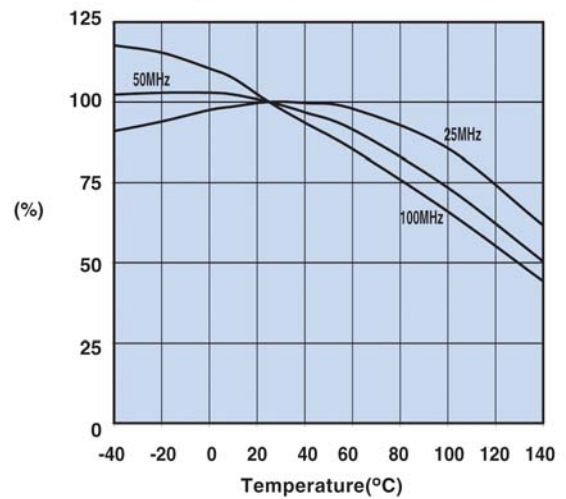

Measured on a 2644000301 using the HP4291A.

Initial Permeability vs. Temperature

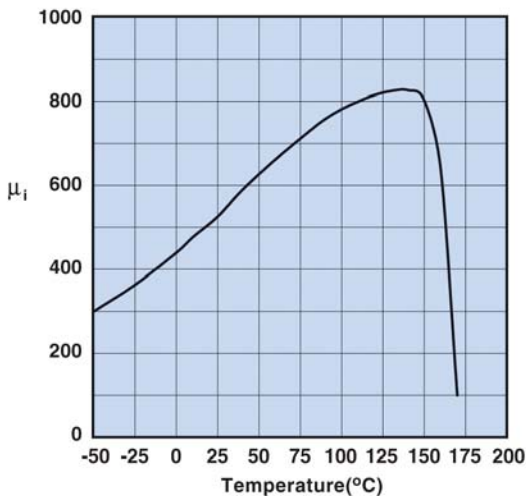

Measured on a 17/10/6mm toroid at 100 kHz.

Hysteresis Loop

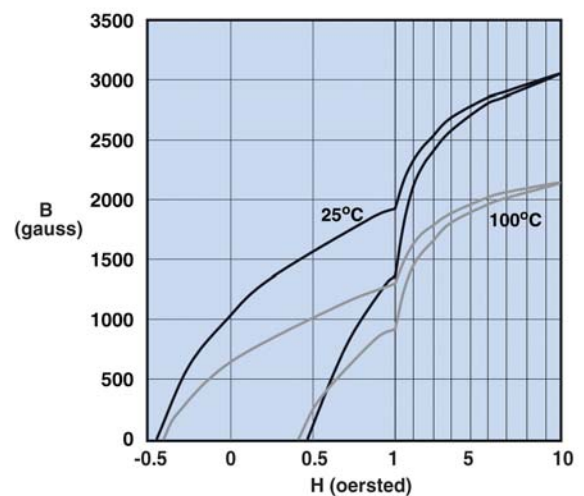

Measured on a 17/10/6mm toroid at 10 kHz.

Our latest material development is a MgZn ferrite intended for suppression applications. This material does not use nickel in its composition, hence it avoids potential environmental issues as well as reduces the cost of the material component of suppression parts. The suppression performance of this 46 material is similar to our widely used 43 material.

The new Fair-Rite grade 46 is supplied in the larger sizes of the round cable EMI suppression and snap-it cores.

46 Material Characteristics:

Property	Unit	Symbol	Value
Initial Permeability @ B < 10 gauss		μ_i	500
Flux Density @ Field Strength	gauss oersted	B H	3000 10
Residual Flux Density	gauss	B_r	1900
Coercive Force	oersted	H_c	0.40
Loss Factor @ Frequency	10^{-6} MHz	$\tan \delta / \mu_i$	60 0.1
Temperature Coefficient of Initial Permeability (20 -70°C)	%/°C		-----
Curie Temperature	°C	T_c	>140
Resistivity	Ω cm	ρ	1×10^8

Complex Permeability vs. Frequency

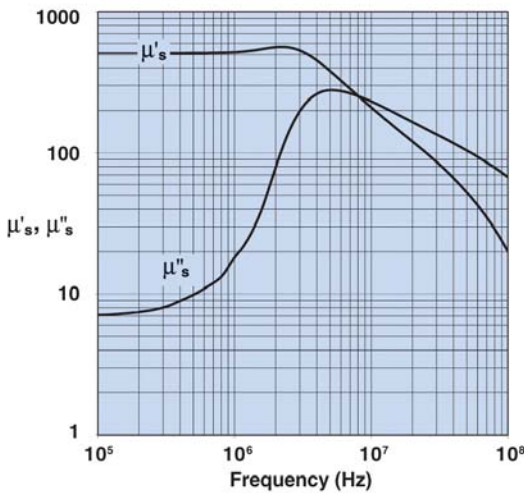

Measured on a 17/10/6mm toroid using the HP 4284A and the HP 4291A.

Percent of Original Impedance vs. Temperature

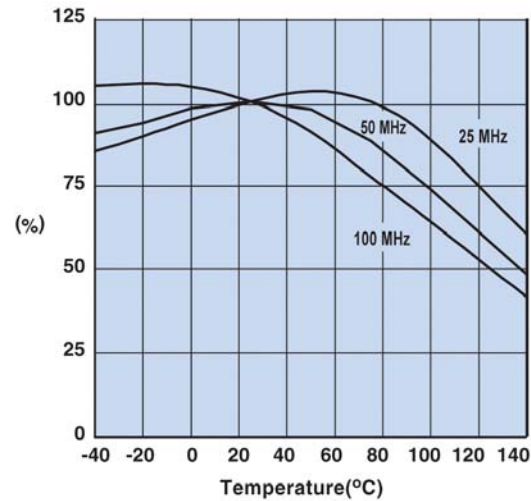

Measured on a 2646000301 using the HP4291A.

Initial Permeability vs. Temperature

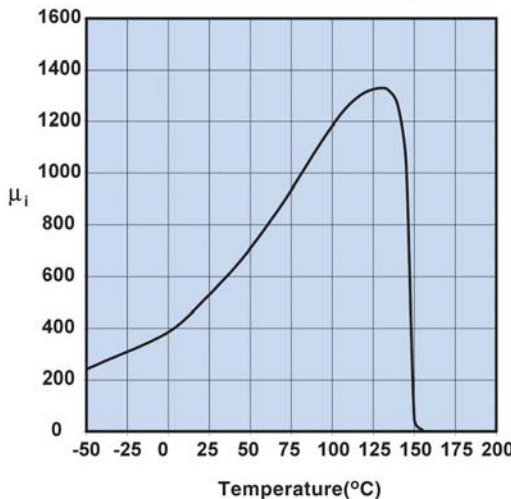

Measured on a 17/10/6mm toroid at 100 kHz.

Hysteresis Loop

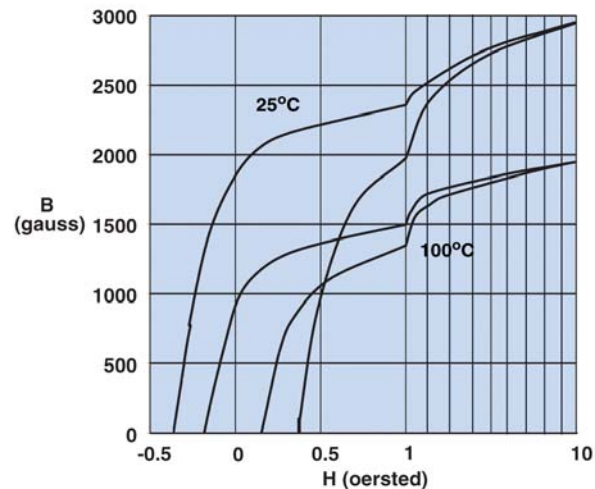

Measured on a 17/10/6mm toroid at 10 kHz.

An economical MnZn ferrite designed for use in open circuit applications for frequencies up to 3.0 MHz.

Rods are available in 33 material.

Not recommended for new designs.

33 Material Characteristics:

Property	Unit	Symbol	Value
Initial Permeability @ B < 10 gauss		μ_i	600
Flux Density @ Field Strength	gauss oersted	B H	2800 5
Residual Flux Density	gauss	B_r	1200
Coercive Force	oersted	H_c	0.60
Loss Factor @ Frequency	10^{-6} MHz	$\tan \delta / \mu_i$	25 0.2
Temperature Coefficient of Initial Permeability (20 -70°C)	%/°C		0.10
Curie Temperature	°C	T_c	>150
Resistivity	Ω cm	ρ	1×10^2

Complex Permeability vs. Frequency

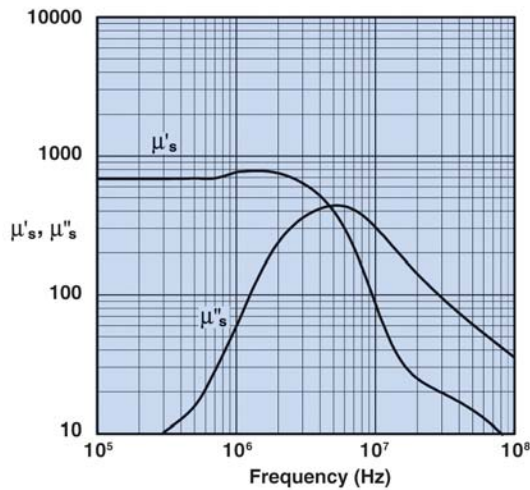

Measured on a 17/10/6mm toroid using the HP 4284A and, the HP 4291A.

Initial Permeability vs. Temperature

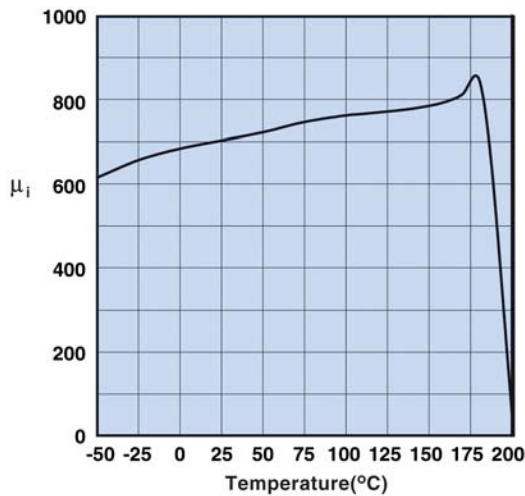

Measured on a 17/10/6mm toroid at 100 kHz.

Hysteresis Loop

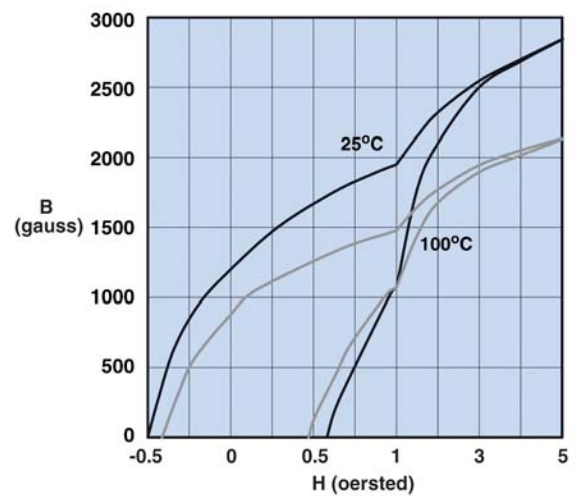

Measured on a 17/10/6mm toroid at 10 kHz.

This NiZn is our most popular ferrite for suppression of conducted EMI from 20 MHz to 250 MHz. This material is also used for inductive applications such as high frequency common-mode chokes.

EMI suppression beads, beads on leads, SM beads, multi-aperture cores, round cable EMI suppression cores, round cable snap-its, flat cable EMI suppression cores, flat cable snap-its, miscellaneous suppression cores, bobbins, and toroids are all available in 43 material.

43 Material Characteristics:

Property	Unit	Symbol	Value
Initial Permeability @ B < 10 gauss		μ_i	800
Flux Density @ Field Strength	gauss oersted	B H	2900 10
Residual Flux Density	gauss	B_r	1300
Coercive Force	oersted	H_c	0.45
Loss Factor @ Frequency	10^{-6} MHz	$\tan \delta / \mu_i$	250 1.0
Temperature Coefficient of Initial Permeability (20 -70°C)	%/°C		1.25
Curie Temperature	°C	T_c	>130
Resistivity	Ω cm	ρ	1×10^5

Complex Permeability vs. Frequency

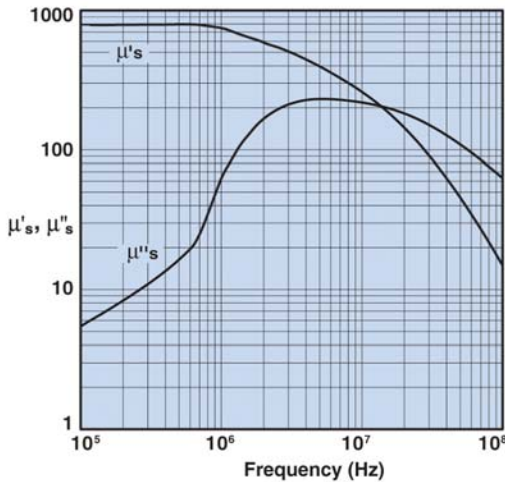

Measured on a 17/10/6mm toroid using the HP 4284A and the HP 4291A.

Percent of Original Impedance vs. Temperature

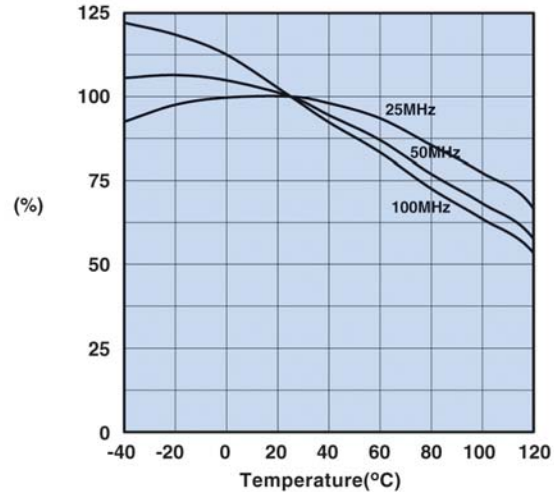

Measured on a 2643000301 using the HP4291A.

Initial Permeability vs. Temperature

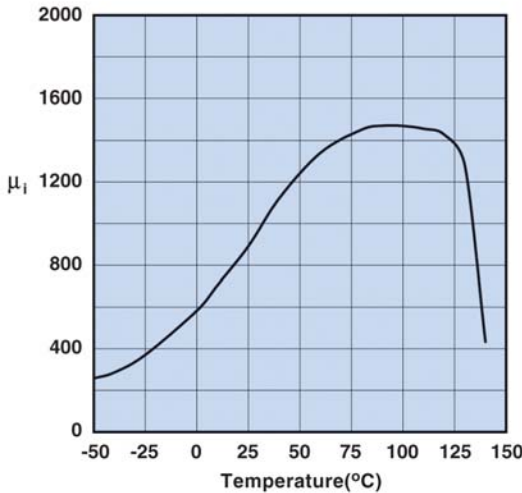

Measured on a 17/10/6mm toroid at 100 kHz.

Hysteresis Loop

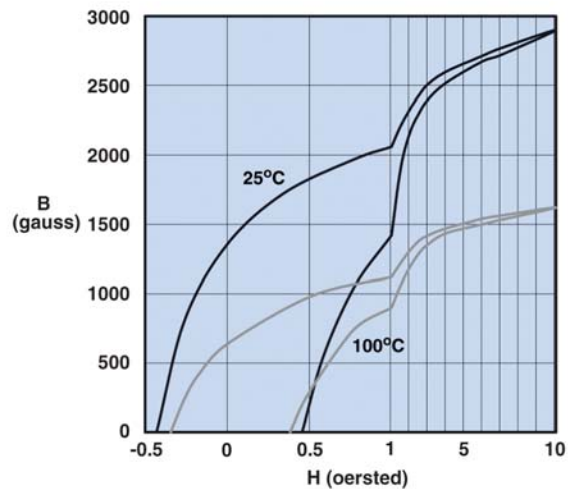

Measured on a 17/10/6mm toroid at 10 kHz.

A MnZn ferrite designed specifically for EMI suppression applications from as low as 1 MHz up to 500 MHz. This material does not have the dimensional resonance limitations associated with conventional MnZn ferrite materials.

Round cable EMI suppression cores, round cable snap-its, flat cable EMI suppression cores, and flat cable snap-its are all available in 31 material.

31 Material Characteristics:

Property	Unit	Symbol	Value
Initial Permeability @ B < 10 gauss		μ_i	1500
Flux Density @ Field Strength	gauss oersted	B H	3400 5
Residual Flux Density	gauss	B_r	2500
Coercive Force	oersted	H_c	0.35
Loss Factor @ Frequency	10^{-6} MHz	$\tan \delta / \mu_i$	20 0.1
Temperature Coefficient of Initial Permeability (20 -70°C)	%/°C		1.6
Curie Temperature	°C	T_c	>130
Resistivity	Ω cm	ρ	3×10^9

Complex Permeability vs. Frequency

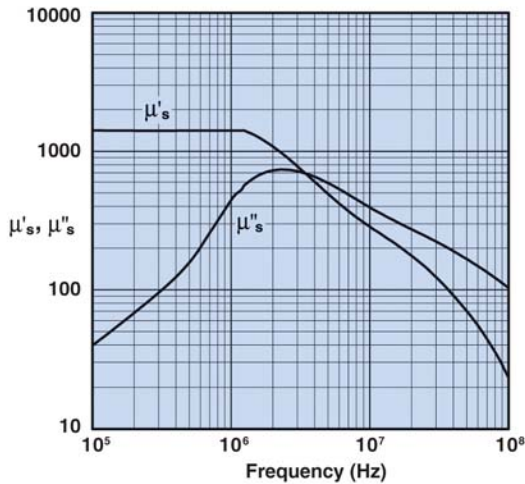

Measured on a 17/10/6mm toroid at 25°C using the HP 4284A and the HP 4291A.

Percent of Original Impedance vs. Temperature

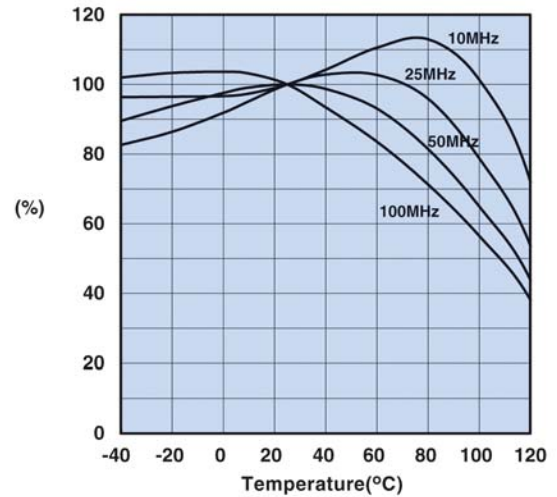

Measured on a 2631000301 using the HP4291A.

Initial Permeability vs. Temperature

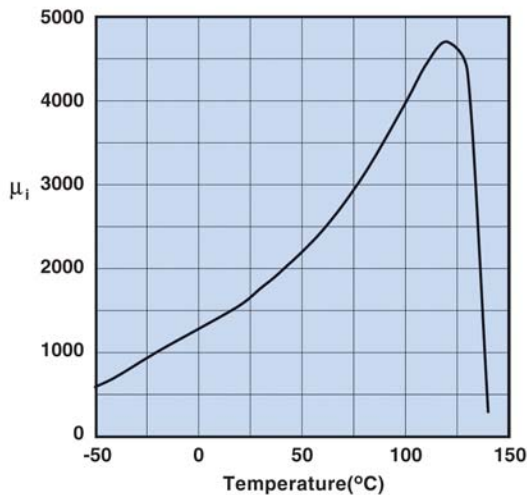

Measured on a 17/10/6mm toroid at 100 kHz.

Hysteresis Loop

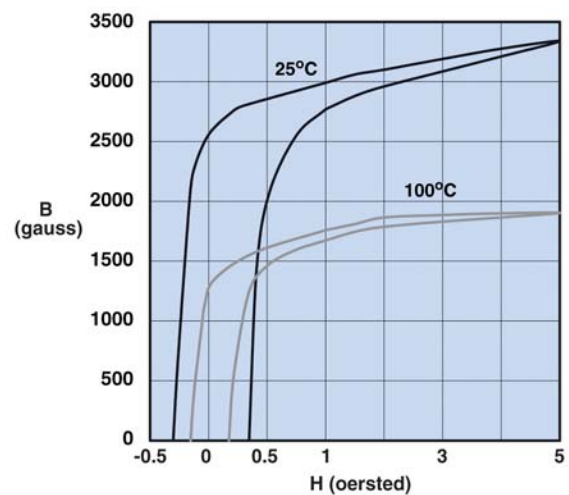

Measured on a 17/10/6mm toroid at 10 kHz.

A new high frequency material for power applications up to 750 kHz.

This MnZn power ferrite is available in customer specific core designs.

This material is available as special order for customer specific applications.

79 Material Characteristics:

Property	Unit	Symbol	Value
Initial Permeability @ B < 10 gauss		μ_i	1400
Flux Density @ Field Strength	gauss oersted	B H	4700 5
Residual Flux Density	gauss	B_r	1700
Coercive Force	oersted	H_c	0.40
Loss Factor @ Frequency	10^{-6} MHz	$\tan \delta / \mu_i$	4.0 0.1
Temperature Coefficient of Initial Permeability (20 -70°C)	%/°C		0.6
Curie Temperature	°C	T_c	>225
Resistivity	Ω cm	ρ	2×10^2

Complex Permeability vs. Frequency

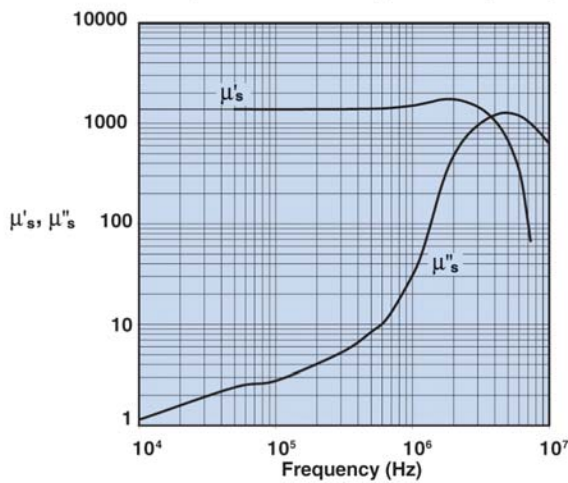

Measured on an 18/10/6mm toroid using the HP 4284A and the HP 4291A.

Incremental Permeability vs. H

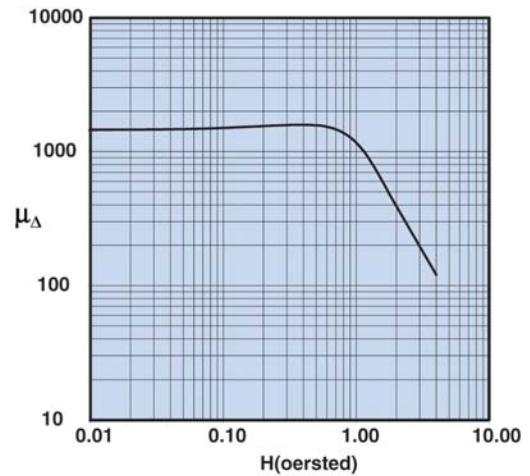

Initial Permeability vs. Temperature

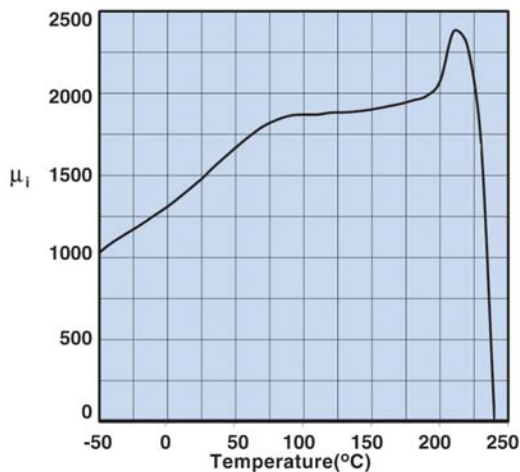

Measured on an 18/10/6mm toroid at 100 kHz.

Hysteresis Loop

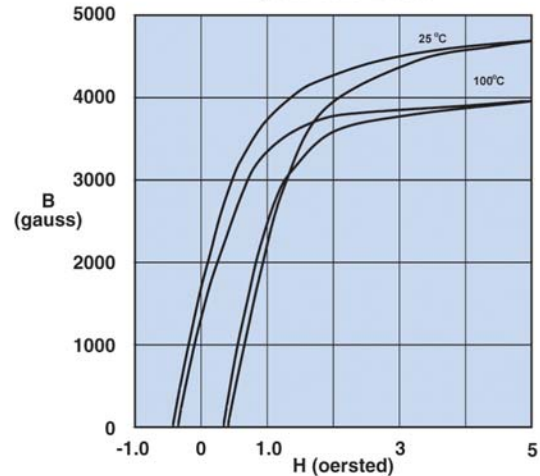

Measured on an 18/10/6mm toroid at 10 kHz.

Amplitude Permeability vs. Flux Density

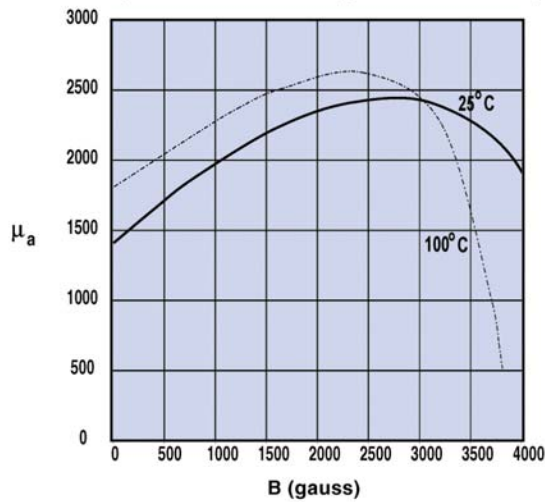

Measured on an 18/10/6mm toroid at 10 kHz.

Power Loss Density vs. Flux Density

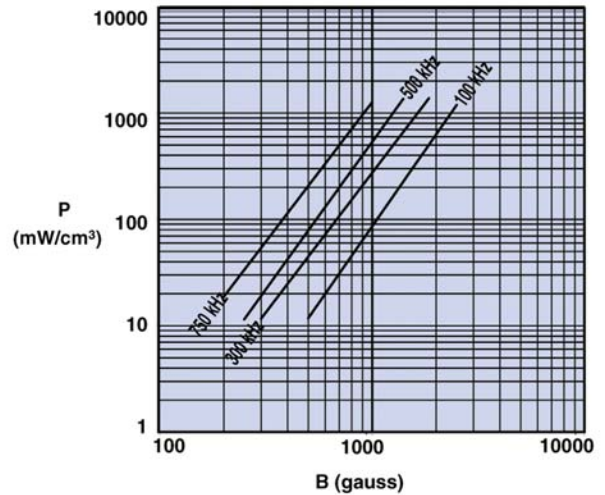

Measured on an 18/10/6mm toroid using the Clarke Hess 258 VAW at 100°C

Power Loss Density vs. Temperature

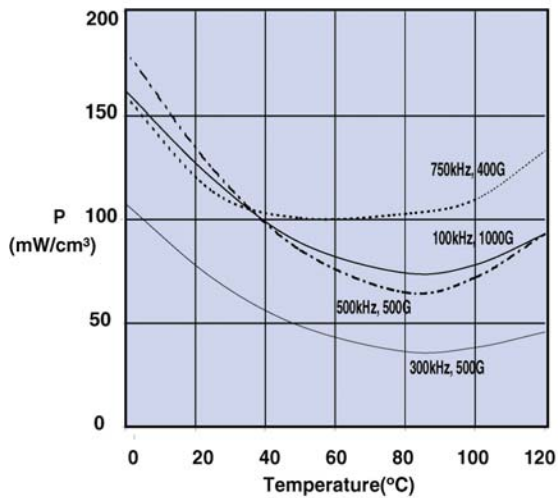

Measured on an 18/10/6mm toroid using the Clarke Hess 258 VAW.

Flux Density vs. Temperature

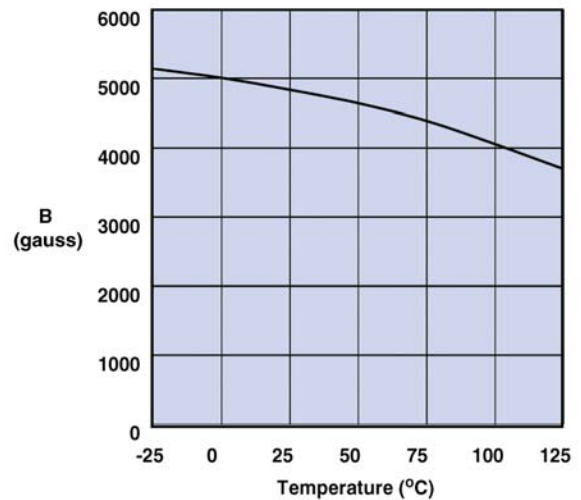

Measured on an 18/10/6mm toroid at 10 kHz. and H=5 oersted.

A MnZn ferrite for use in a wide range of high and low flux density inductive designs for frequencies up to 100 kHz.

Pot cores, E&I cores, U cores, rods, toroids, and bobbins are all available in 77 material.

77 Material Characteristics:

Property	Unit	Symbol	Value
Initial Permeability @ B < 10 gauss		μ_i	2000
Flux Density @ Field Strength	gauss oersted	B H	4900 5
Residual Flux Density	gauss	B_r	1800
Coercive Force	oersted	H_c	0.30
Loss Factor @ Frequency	10^{-6} MHz	$\tan \delta / \mu_i$	15 0.1
Temperature Coefficient of Initial Permeability (20 -70°C)	%/°C		0.7
Curie Temperature	°C	T_c	>200
Resistivity	Ω cm	ρ	1×10^2

Complex Permeability vs. Frequency

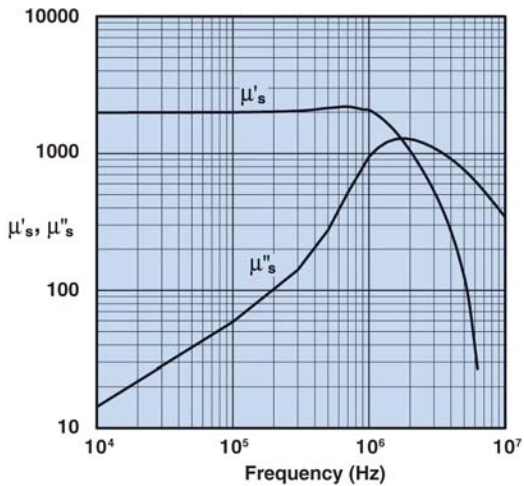

Measured on an 18/10/6mm toroid using the HP 4284A and the HP 4291A.

Incremental Permeability vs. H

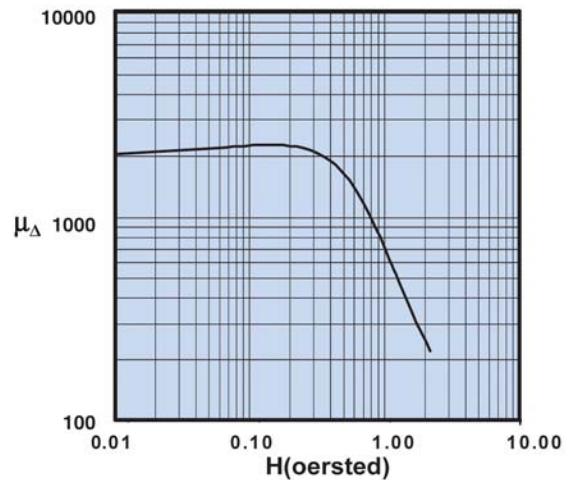

Initial Permeability vs. Temperature

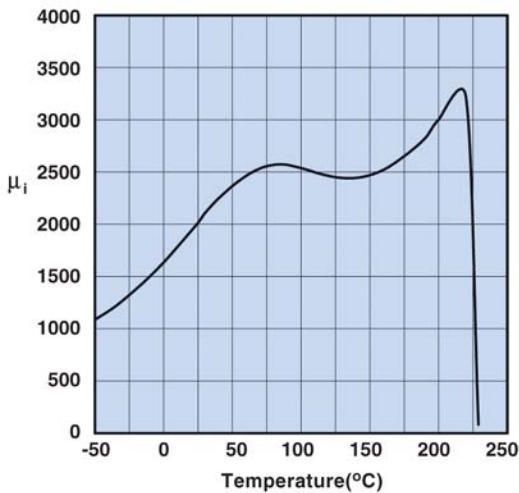

Measured on an 18/10/6mm toroid at 100 kHz.

Hysteresis Loop

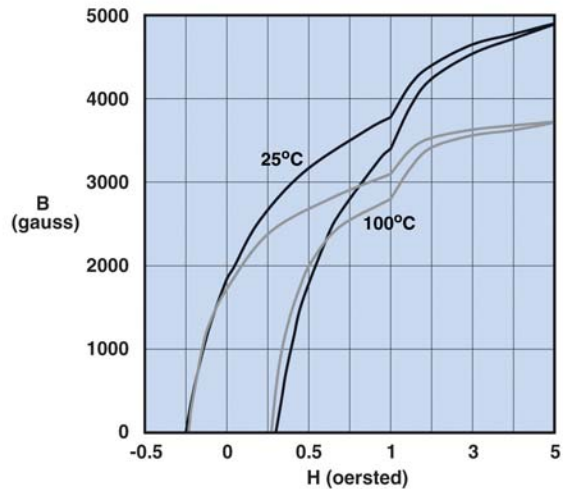

Measured on an 18/10/6mm toroid at 10 kHz.

Amplitude Permeability vs. Flux Density

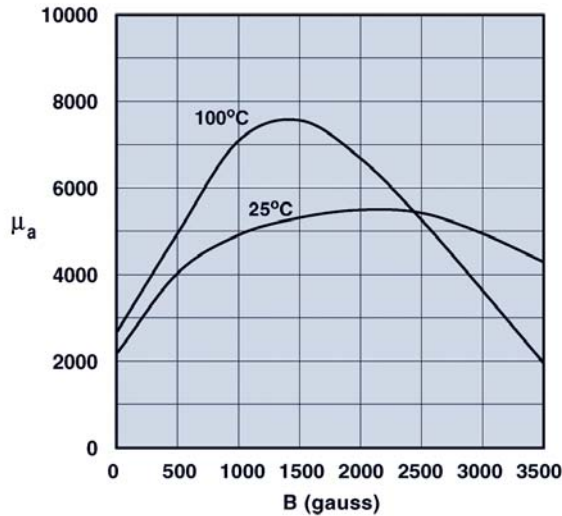

Measured on an 18/10/6mm toroid at 10 kHz.

Power Loss Density vs. Flux Density

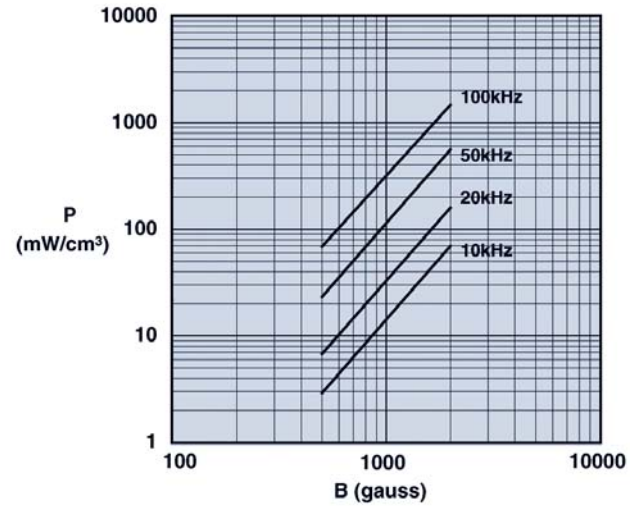

Measured on an 18/10/6mm toroid using the Clarke Hess 258 VAW at 100°C

Power Loss Density vs. Temperature

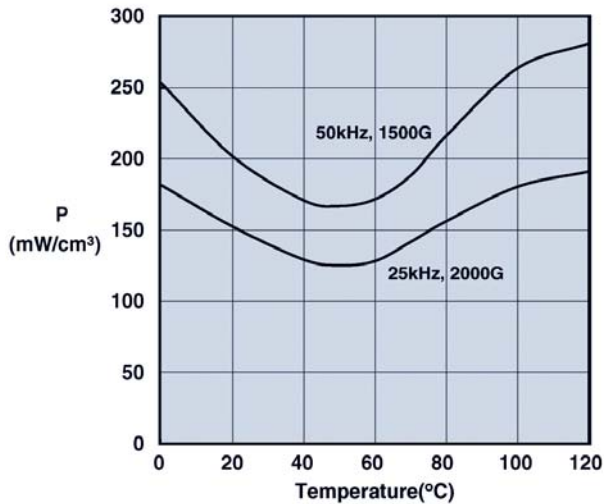

Measured on an 18/10/6mm toroid using the Clarke Hess 258 VAW.

Flux Density vs. Temperature

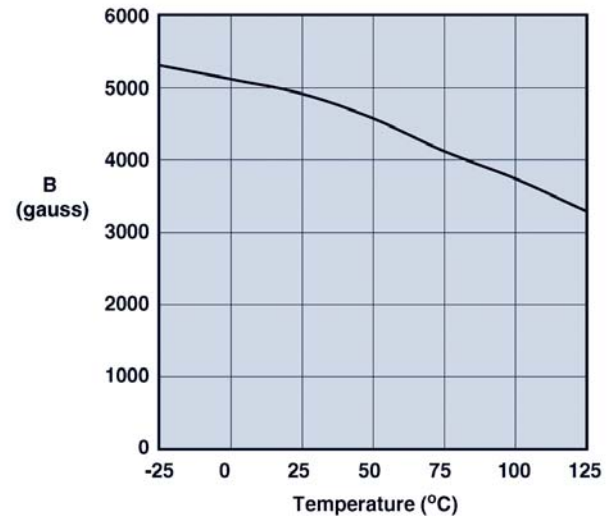

Measured on an 18/10/6mm toroid at 10 kHz and H=5 oersted.

97 Material



A low loss MnZn ferrite material for power applications up to 400 kHz.
 New type 97 Material is a low loss/higher frequency power material. It features minimal power loss at 100°C at moderate flux densities for operation below 400 kHz.

This material is available as special order for customer specific applications.

97 Material Characteristics

Property	Unit	Symbol	Value
Initial Permeability @ B < 10gauss		μ_i	2000
Flux Density @ Field Strength	gauss oersted	B H	5000 5
Residual Flux Density	gauss	B_r	1500
Coercive Force	oersted	H_c	0.16
Loss Factor @ Frequency	10^{-6} MHz	$\tan\delta/\mu_i$	3.5 0.1
Temperature Coefficient of Initial Permeability (20 - 70°C)	% / °C		1.4
Curie Temperature	°C	T_c	> 220
Resistivity	ohm-cm	ρ	200

Complex Permeability vs. Frequency

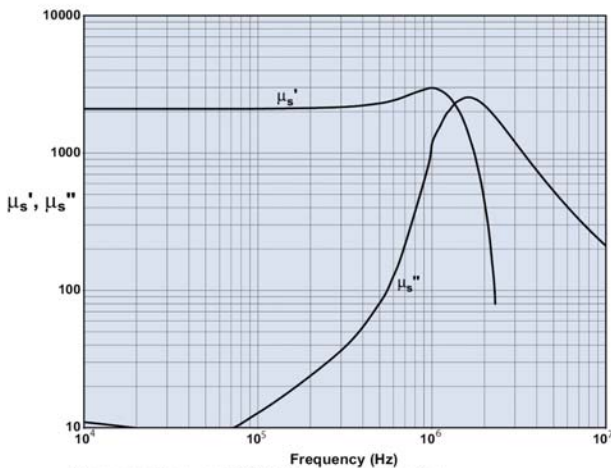

Measured on an 18/10/6mm toroid using HP 4284A and HP4291A.

Incremental Permeability vs. H

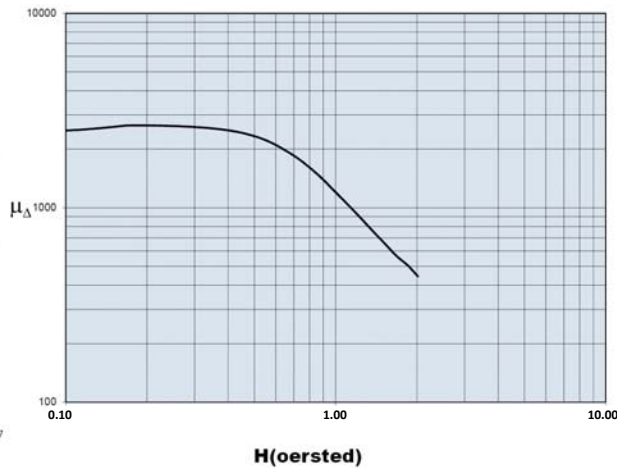

Initial Permeability vs. Temperature

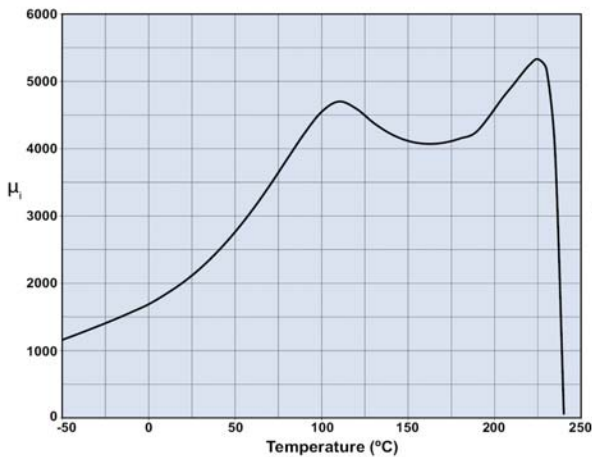

Measured on an 18/10/6mm toroid at 10kHz.

Hysteresis Loop

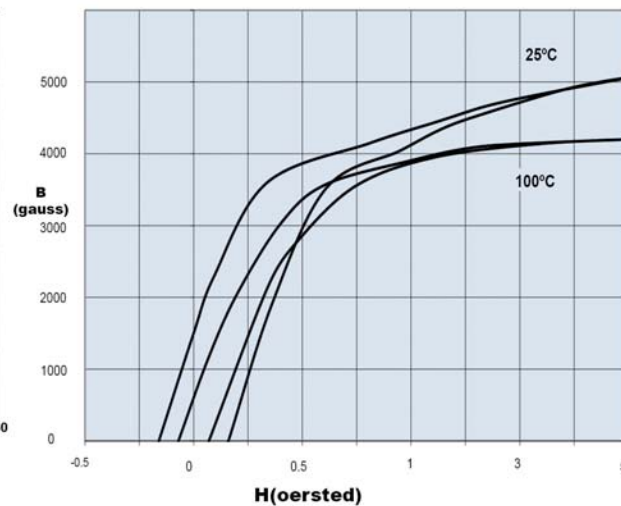

Measured on an 18/10/6mm toroid at 10kHz.

A low loss MnZn ferrite material for power applications up to 400kHz.

Amplitude Permeability vs. Flux Density

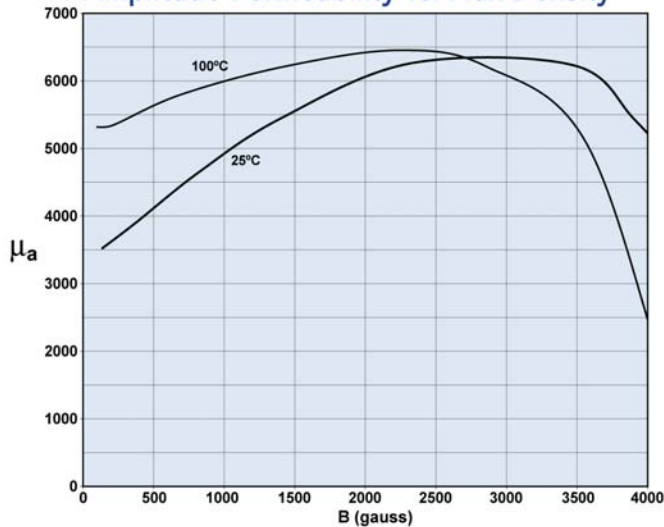

Measured on an 18/10/6mm toroid at 10kHz.

Power Loss Density vs. Flux Density

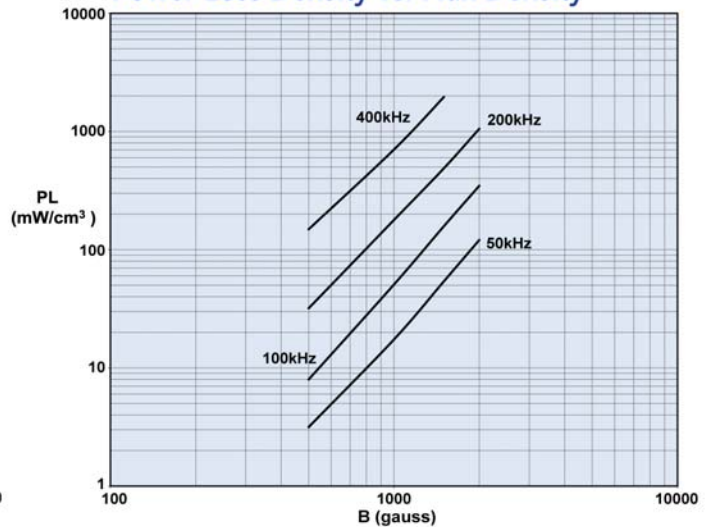

Measured on an 18/10/6mm toroid using the Clarke Hess 258 VAW at 100°C.

Power Loss Density vs. Temperature

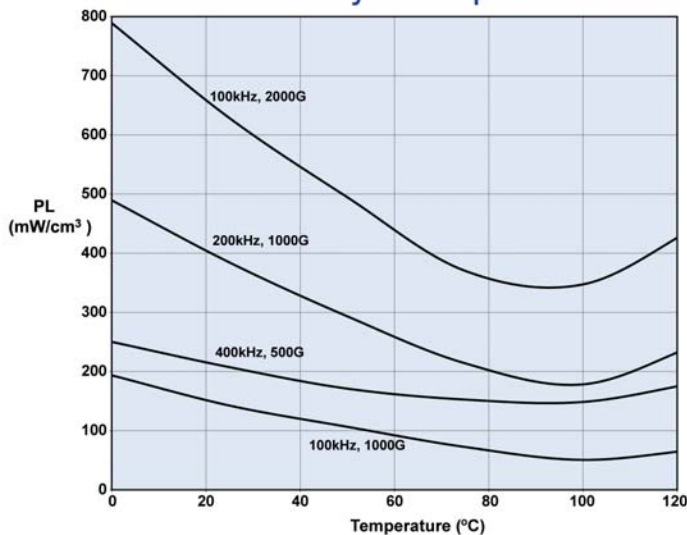

Measured on an 18/10/6mm toroid using the Clarke Hess 258 VAW.

Flux Density vs. Temperature

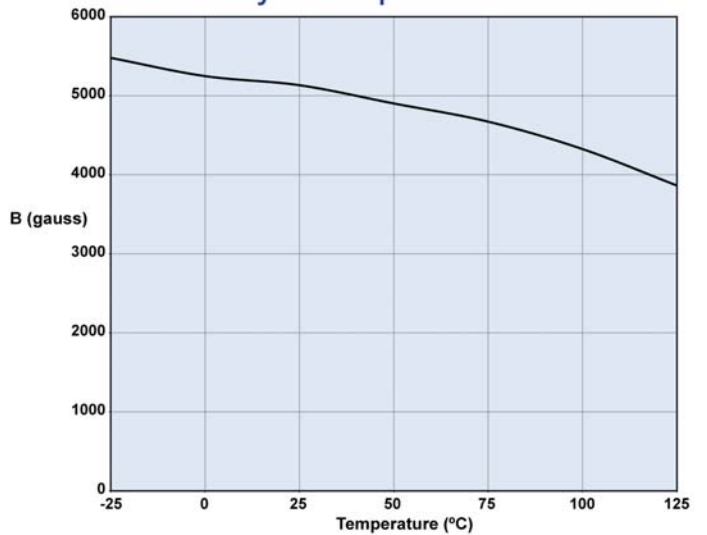

Measured on an 18/10/6mm toroid at 10kHz and H=5 oersted.

A MnZn ferrite specifically designed for power applications for frequencies up to 200 kHz.

RFID rods, toroids, U cores, and E&I cores are all available in 78 material.

78 Material Characteristics:

Property	Unit	Symbol	Value
Initial Permeability @ B < 10 gauss		μ_i	2300
Flux Density @ Field Strength	gauss oersted	B H	4800 5
Residual Flux Density	gauss	B_r	1500
Coercive Force	oersted	H_c	0.20
Loss Factor @ Frequency	10^{-6} MHz	$\tan \delta / \mu_i$	4.5 0.1
Temperature Coefficient of Initial Permeability (20 -70°C)	%/°C		1.0
Curie Temperature	°C	T_c	>200
Resistivity	Ω cm	ρ	2×10^2

Complex Permeability vs. Frequency

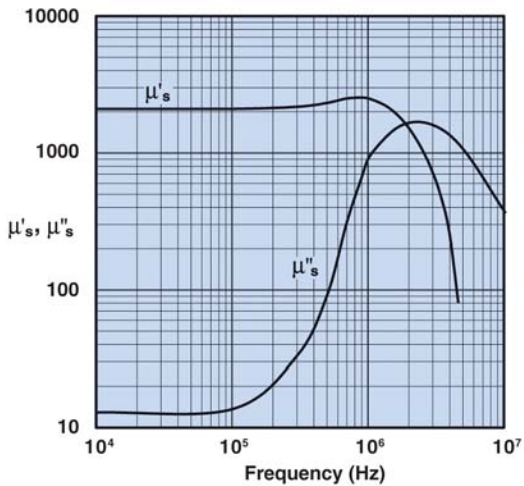

Measured on an 18/10/6mm toroid using the HP 4284A and the HP 4291A.

Incremental Permeability vs. H

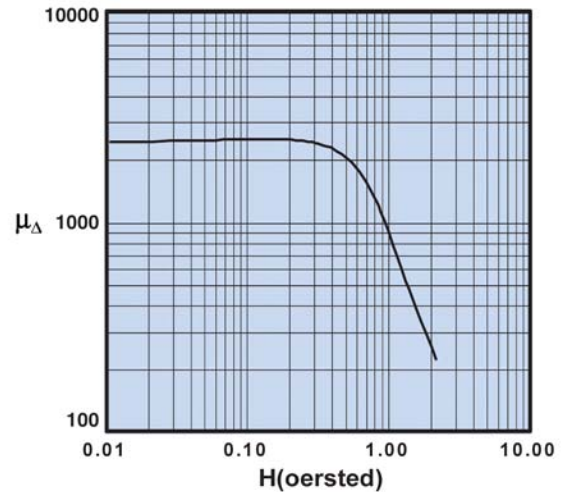

Initial Permeability vs. Temperature

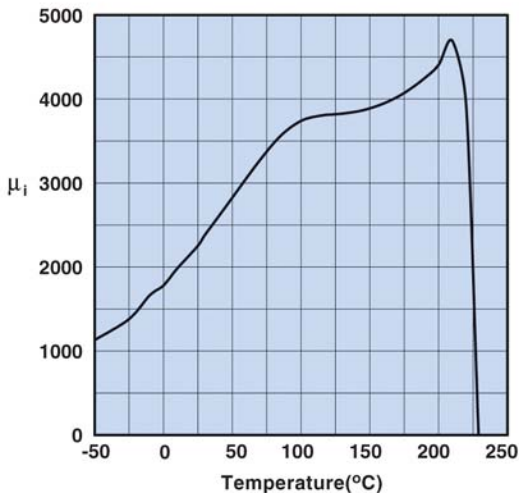

Measured on an 18/10/6mm toroid at 100 kHz.

Hysteresis Loop

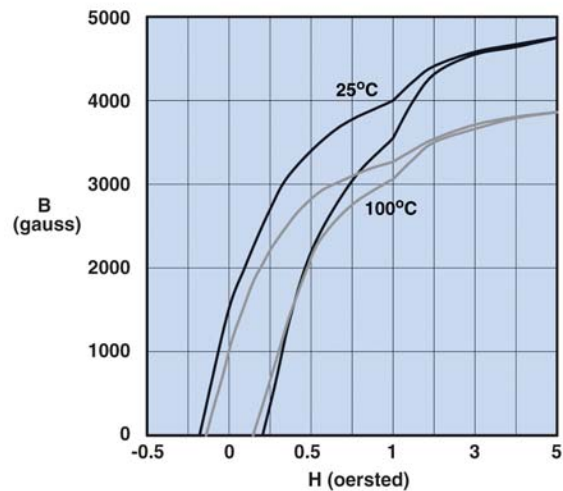

Measured on an 18/10/6mm toroid at 10 kHz.

Amplitude Permeability vs. Flux Density

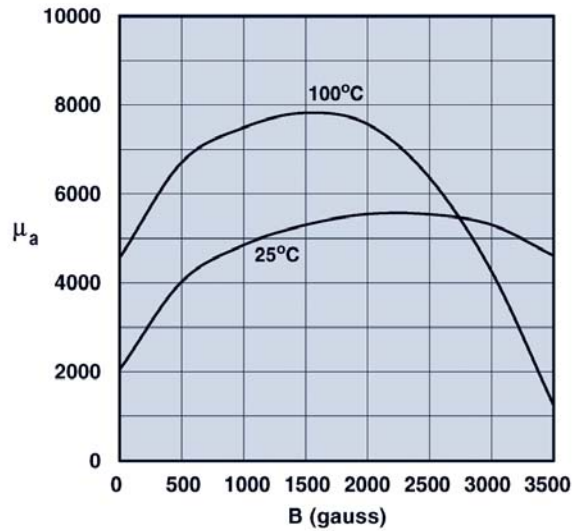

Measured on an 18/10/6mm toroid at 10 kHz.

Power Loss Density vs. Flux Density

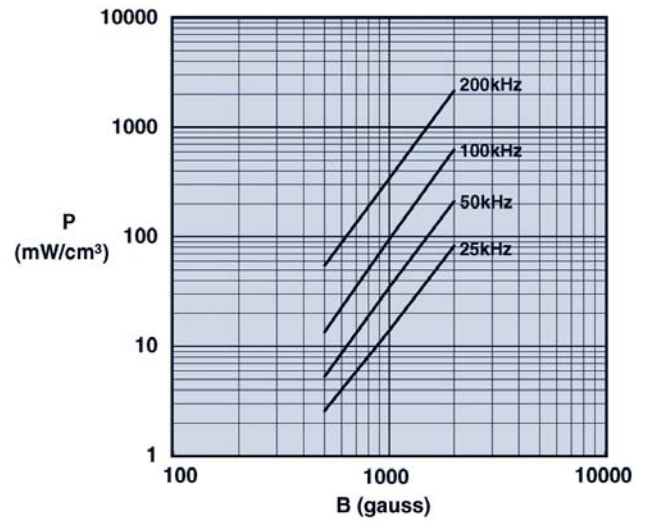

Measured on an 18/10/6mm toroid using the Clarke Hess 258 VAW at 100°C

Power Loss Density vs. Temperature

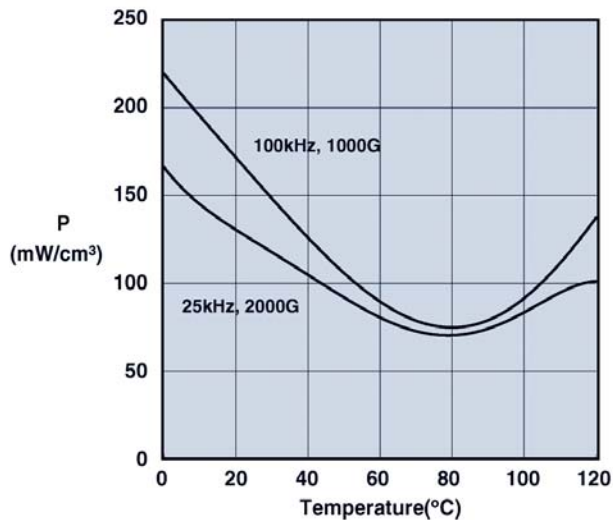

Measured on an 18/10/6mm toroid using the Clarke Hess 258 VAW.

Flux Density vs. Temperature

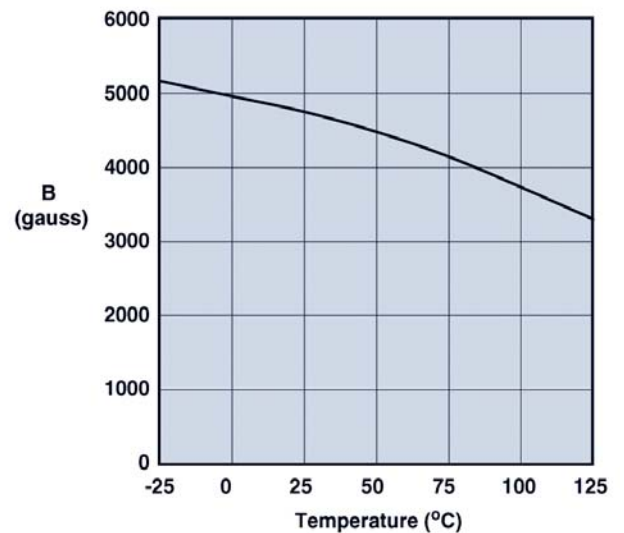

Measured on an 18/10/6 mm toroid at 10 kHz and H=5 oersted.

A low loss MnZn ferrite material for power applications up to 200 kHz.

New type 98 Material is an improved version of Fair-Rite's 78 Material, this material supplies, lower power loss at 100°C at moderate flux densities for operation below 200 kHz.

Shapes available in 98 material are Toroids, U Cores, E & I Cores, Pot Cores, RM, PQ, ETD, EFD, EP, EER.

98 Material Characteristics

Property	Unit	Symbol	Value
Initial Permeability @ B < 10gauss		μ_i	2400
Flux Density @ Field Strength	gauss oersted	B H	5000 5
Residual Flux Density	gauss	B_r	1800
Coercive Force	oersted	H_c	0.17
Loss Factor @ Frequency	10^{-6} MHz	$\tan\delta/\mu_i$	3.5 0.1
Temperature Coefficient of Initial Permeability (20 - 70°C)	% / °C		1.5
Curie Temperature	°C	T_c	> 215
Resistivity	ohm-cm	ρ	200

Complex Permeability vs. Frequency

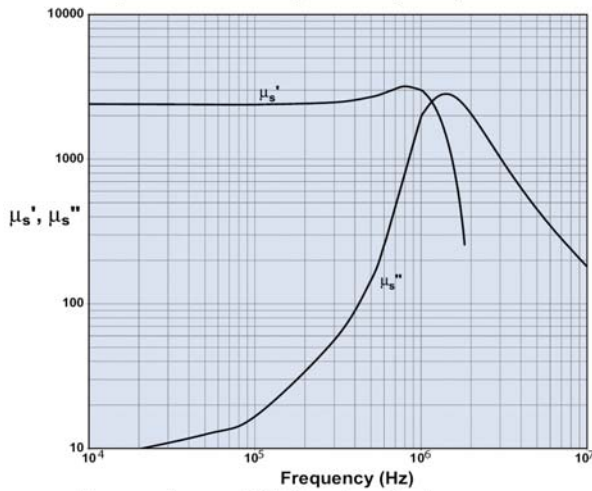

Measured on an 18/10/6mm toroid using HP 4284A and HP4291A.

Incremental Permeability vs. H



Initial Permeability vs. Temperature

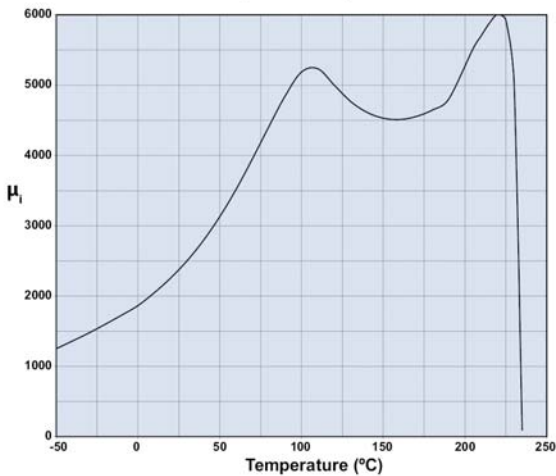

Measured on an 18/10/6mm toroid at 10kHz.

Hysteresis Loop

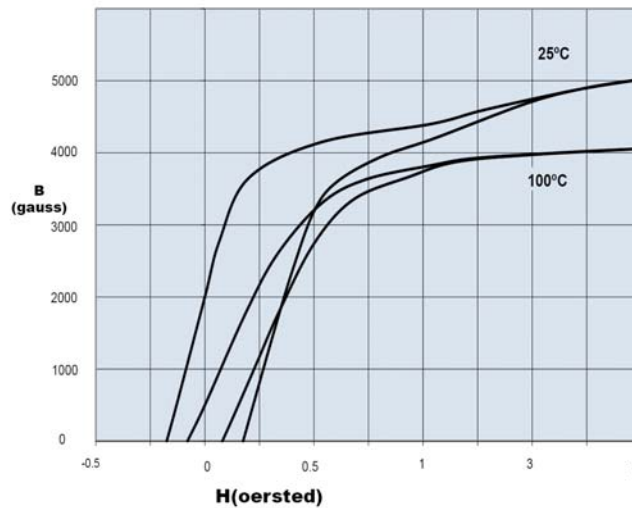

Measured on an 18/10/6mm toroid at 10kHz.

A low loss MnZn ferrite material for power applications up to 200kHz.

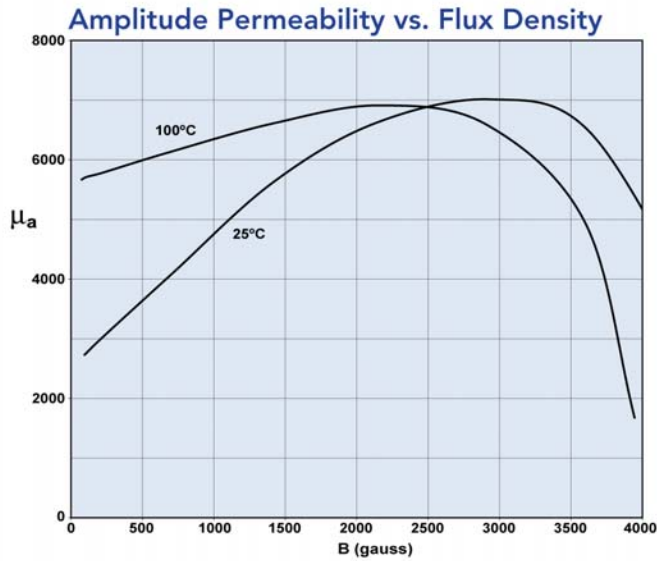

Measured on an 18/10/6mm toroid at 10kHz.

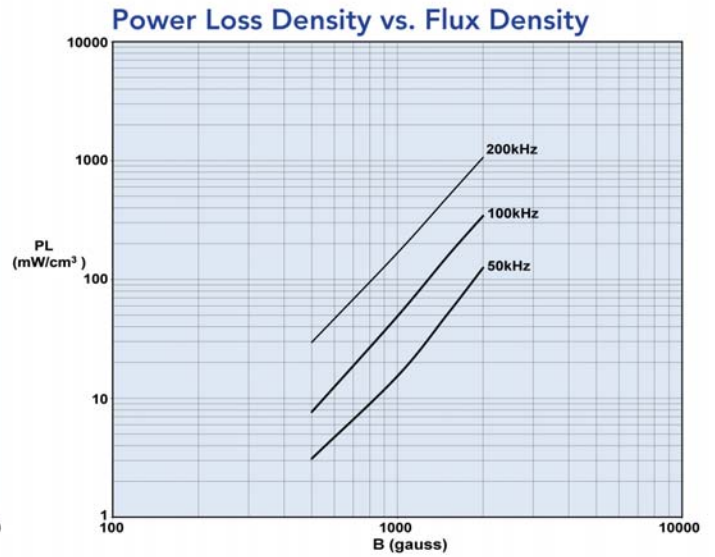

Measured on an 18/10/6mm toroid using the Clarke Hess 258 VAW at 100°C.

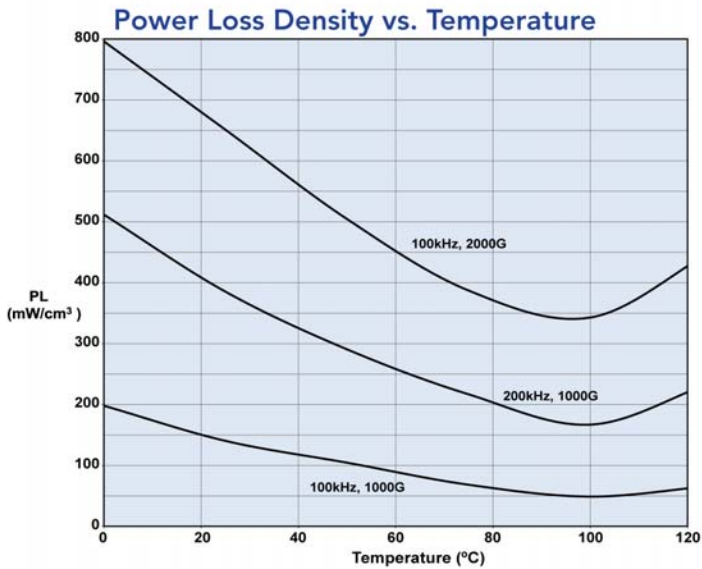

Measured on an 18/10/6mm toroid using the Clarke Hess 258 VAW.

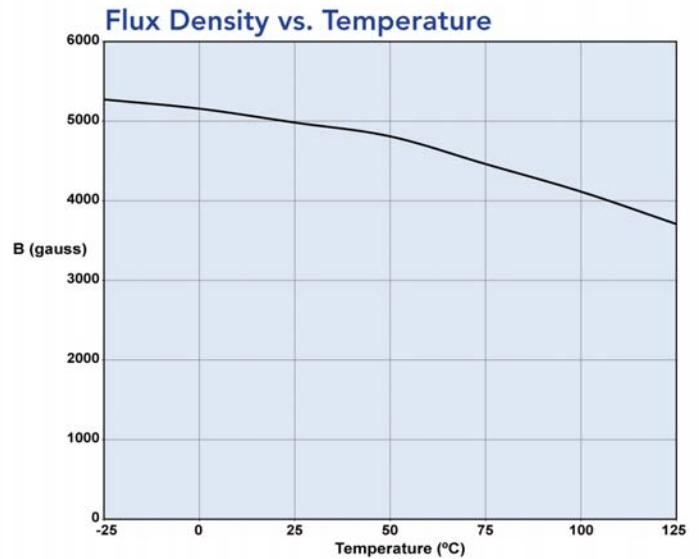

Measured on an 18/10/6mm toroid at 10kHz and H=5 oersted.

A MnZn ferrite, supplied only in small cores, to suppress conducted EMI frequencies below 50 MHz.

EMI suppression beads, beads on leads, SM beads, and multi-aperture cores are all available in 73 material.

73 Material Characteristics:

Property	Unit	Symbol	Value
Initial Permeability @ B < 10 gauss		μ_i	2500
Flux Density @ Field Strength	gauss oersted	B H	3900 5
Residual Flux Density	gauss	B_r	1500
Coercive Force	oersted	H_c	0.24
Loss Factor @ Frequency	10^{-6} MHz	$\tan \delta / \mu_i$	10 0.1
Temperature Coefficient of Initial Permeability (20 -70°C)	%/°C		0.65
Curie Temperature	°C	T_c	>160
Resistivity	Ω cm	ρ	1×10^2

Complex Permeability vs. Frequency

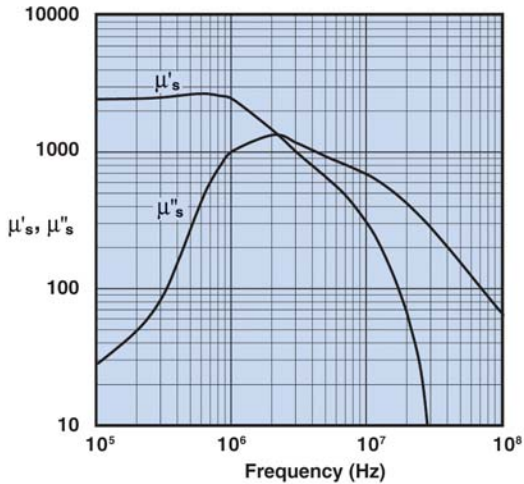

Measured on a 2673000301 bead using the HP 4284A and the HP 4291A.

Percent of Original Impedance vs. Temperature

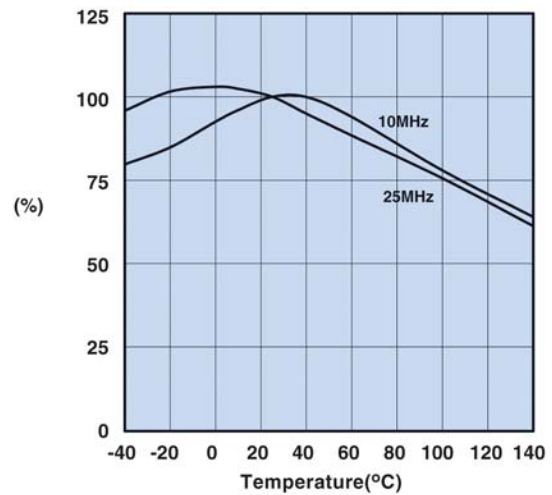

Measured on a 2673000301 using the HP4291A.

Initial Permeability vs. Temperature

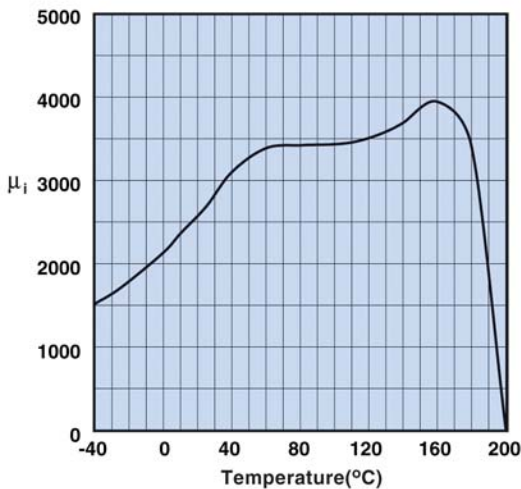

Measured on a 17/10/6mm toroid at 10 kHz.

Hysteresis Loop

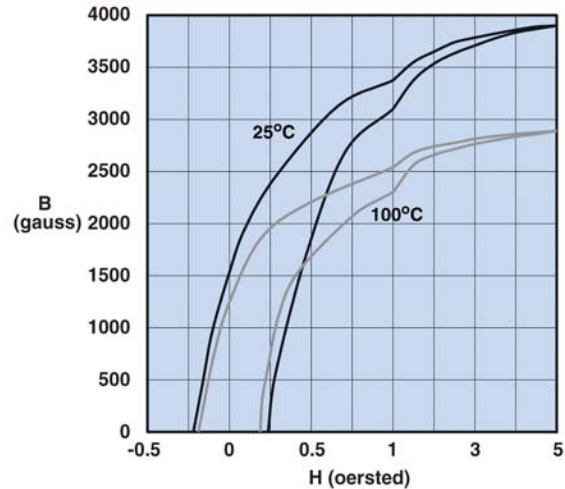

Measured on a 17/10/6mm toroid at 10 kHz.

A low loss MnZn ferrite material for power applications up to 200 kHz with low temperature variation. New type 95 Material is a low loss power material, which features less power loss variation over temperature (25-120°C) at moderate flux densities for operation below 200 kHz.

Shapes available in 95 material are Toroids, U cores, Pot Cores, RM, PQ, EFD, EP.

95 Material Characteristics

Property	Unit	Symbol	Value
Initial Permeability @ B < 10gauss		μ_i	3000
Flux Density @ Field Strength	gauss oersted	B H	5000 5
Residual Flux Density	gauss	B_r	800
Coercive Force	oersted	H_c	0.13
Loss Factor @ Frequency	10^{-6} MHz	$\tan\delta/\mu_i$	3.0 0.1
Temperature Coefficient of Initial Permeability (20 - 70°C)	% / °C		0.4
Curie Temperature	°C	T_c	> 220
Resistivity	ohm-cm	ρ	200

Complex Permeability vs. Frequency

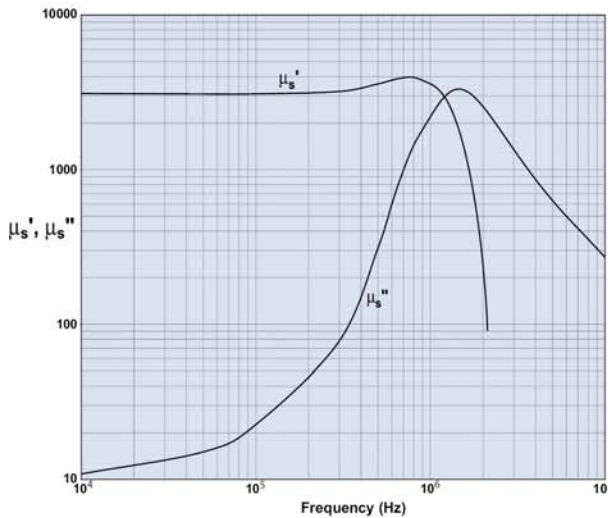

Measured on an 18/10/6mm toroid using HP 4284A and HP4291A.

Incremental Permeability vs. H

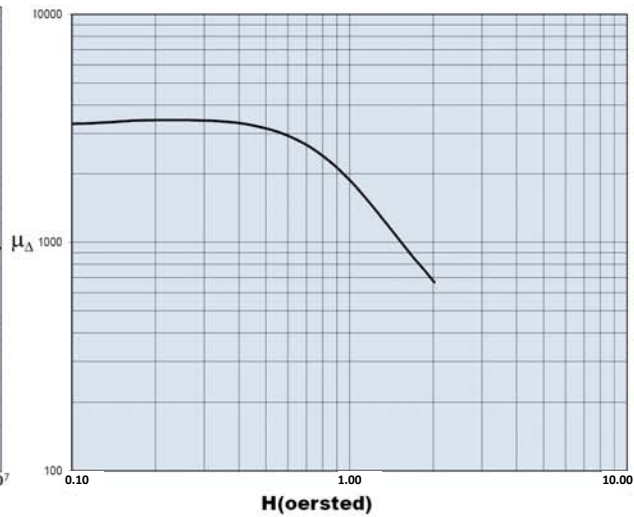

Initial Permeability vs. Temperature

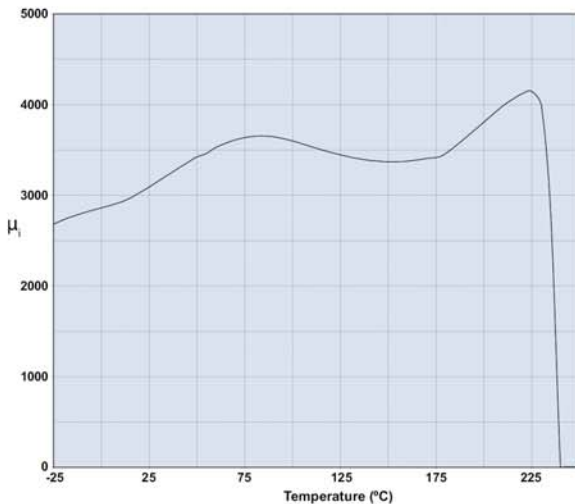

Measured on an 18/10/6mm toroid at 10kHz.

Hysteresis Loop

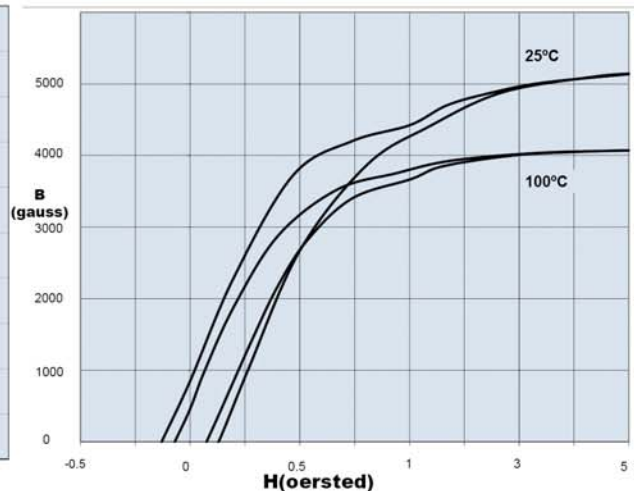

Measured on an 18/10/6mm toroid at 10kHz.

A low loss MnZn ferrite material for power applications up to 200kHz with low temperature variation.

Amplitude Permeability vs. Flux Density

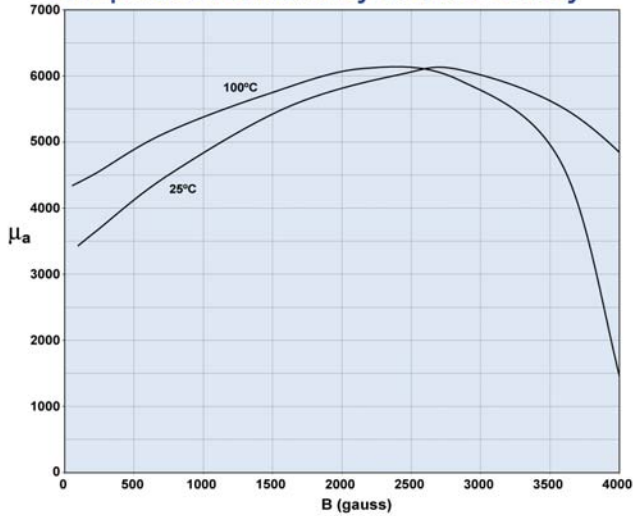

Measured on an 18/10/6mm toroid at 10kHz.

Power Loss Density vs. Flux Density

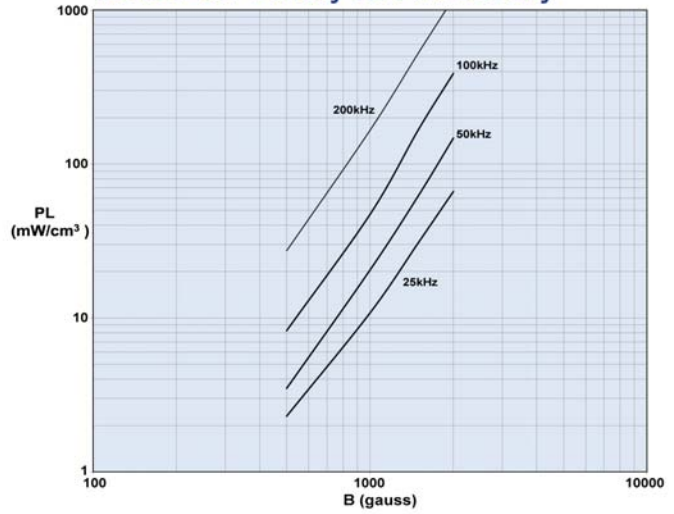

Measured on an 18/10/6mm toroid using the Clarke Hess 258 VAW at 100°C.

Power Loss Density vs. Temperature

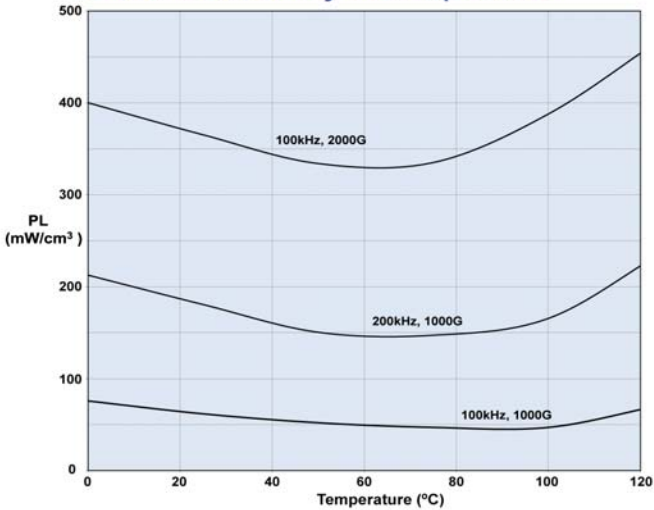

Measured on an 18/10/6mm toroid using the Clarke Hess 258 VAW at 100°C.

Flux Density vs. Temperature

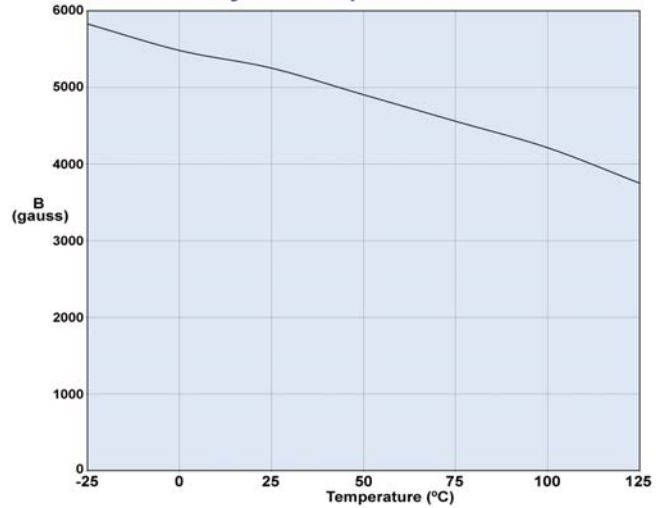

Measured on an 18/10/6mm toroid at 10kHz and H=5 oersted.

A high permeability MnZn ferrite intended for a range of broadband and pulse transformer applications and common-mode inductor designs.

Toroidal cores are available in 75 material.

75 Material Characteristics:

Property	Unit	Symbol	Value
Initial Permeability @ B < 10 gauss		μ_i	5000
Flux Density @ Field Strength	gauss oersted	B H	4300 5
Residual Flux Density	gauss	B_r	1400
Coercive Force	oersted	H_c	0.16
Loss Factor @ Frequency	10^{-6} MHz	$\tan \delta / \mu_i$	15 0.1
Temperature Coefficient of Initial Permeability (20 -70°C)	%/°C		0.6
Curie Temperature	°C	T_c	>140
Resistivity	Ω cm	ρ	3×10^2

Complex Permeability vs. Frequency

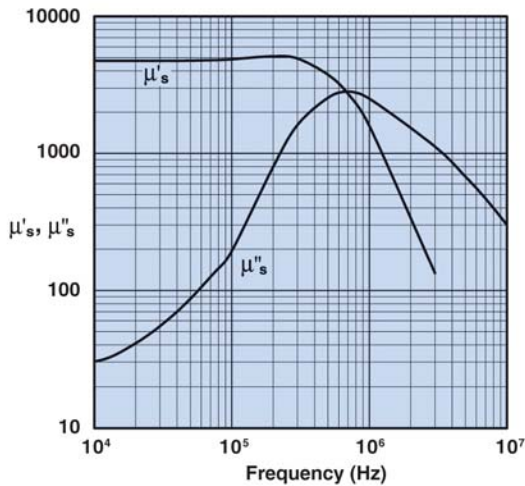

Measured on a 17/10/6mm toroid using the HP 4284A and the HP 4291A.

Power Loss Density vs. Flux Density

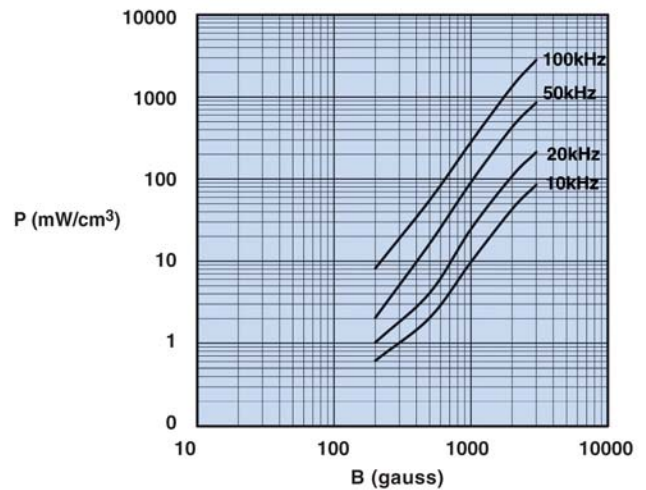

Measured on a 17/10/6mm toroid using the Clarke Hess 258 VAW at 100°C.

Initial Permeability vs. Temperature

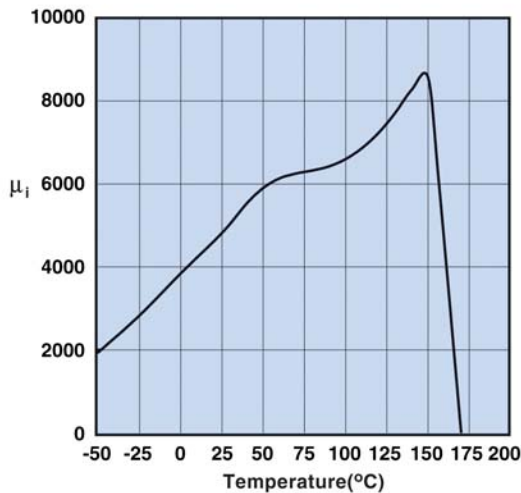

Measured on a 17/10/6mm toroid at 10 kHz.

Hysteresis Loop

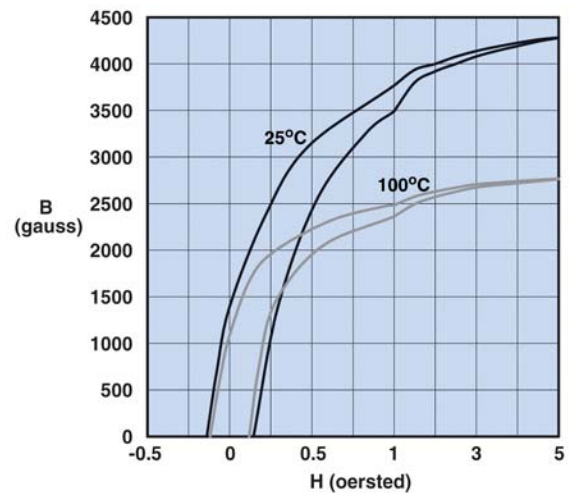

Measured on a 17/10/6mm toroid at 10 kHz.

A MnZn ferrite with a 10K permeability and an acceptable Curie temperature for broadband and pulse transformer designs and common-mode choke applications.

Toroids are available in 76 material.

76 Material Characteristics:

Property	Unit	Symbol	Value
Initial Permeability @ B < 10 gauss		μ_i	10000
Flux Density @ Field Strength	gauss oersted	B H	4000 5
Residual Flux Density	gauss	B_r	1800
Coercive Force	oersted	H_c	0.12
Loss Factor @ Frequency	10^{-6} MHz	$\tan \delta / \mu_i$	15 0.025
Temperature Coefficient of Initial Permeability (20 -70°C)	%/°C		0.5
Curie Temperature	°C	T_c	>120
Resistivity	Ω cm	ρ	50

Complex Permeability vs. Frequency

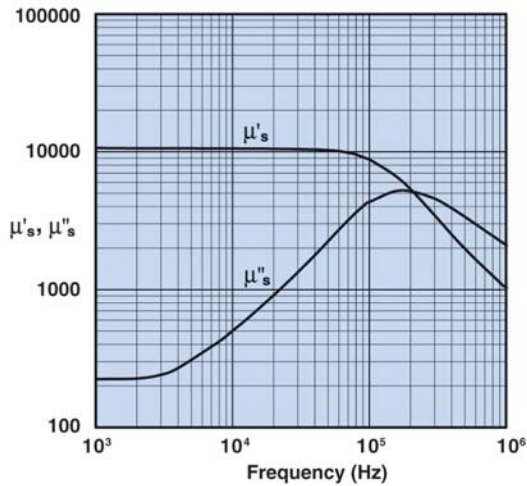

Measured on a 17/10/6mm toroid using the HP 4284A and, the HP 4291A.

Amplitude Permeability vs. Flux Density

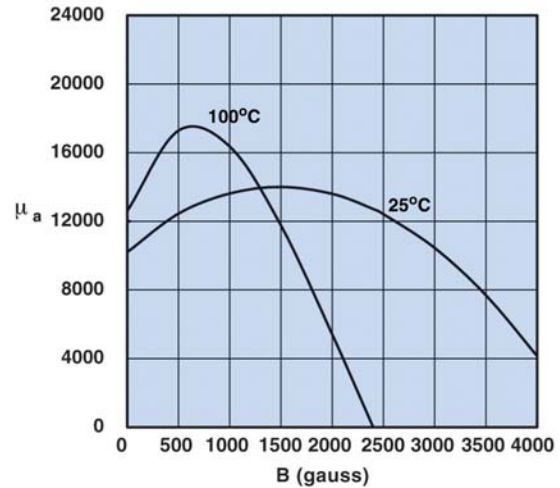

Measured on a 17/10/6mm toroid using the HP 54510A.

Initial Permeability vs. Temperature

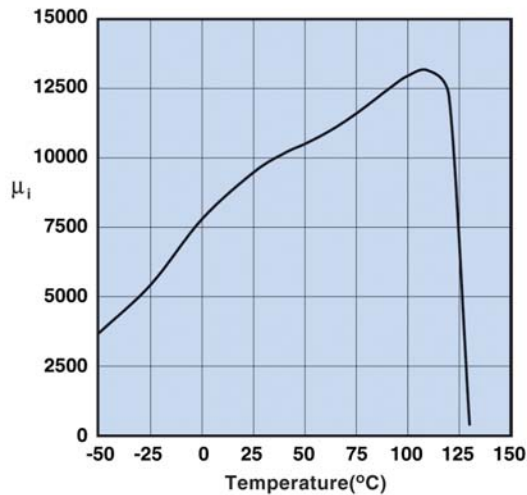

Measured on a 17/10/6mm toroid at 10 kHz.

Hysteresis Loop

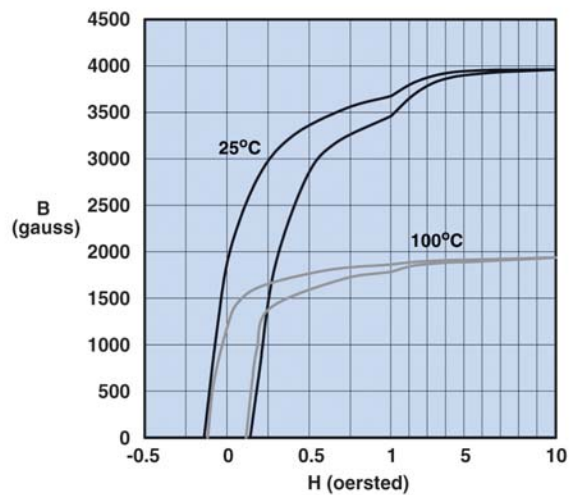

Measured on a 17/10/6mm toroid at 10 kHz.

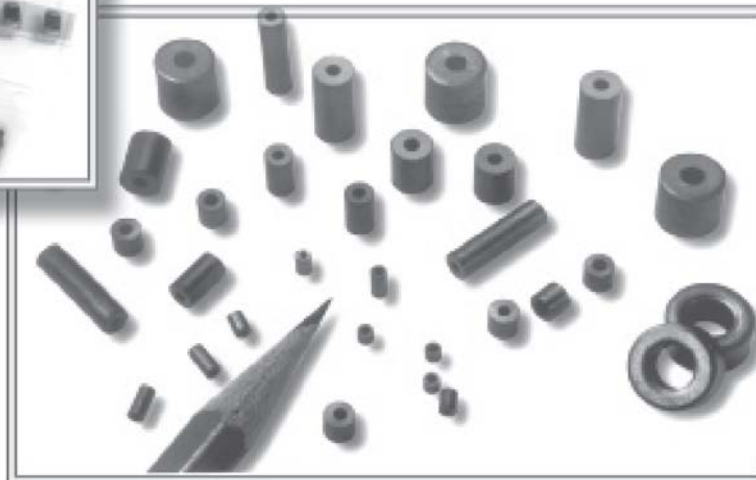
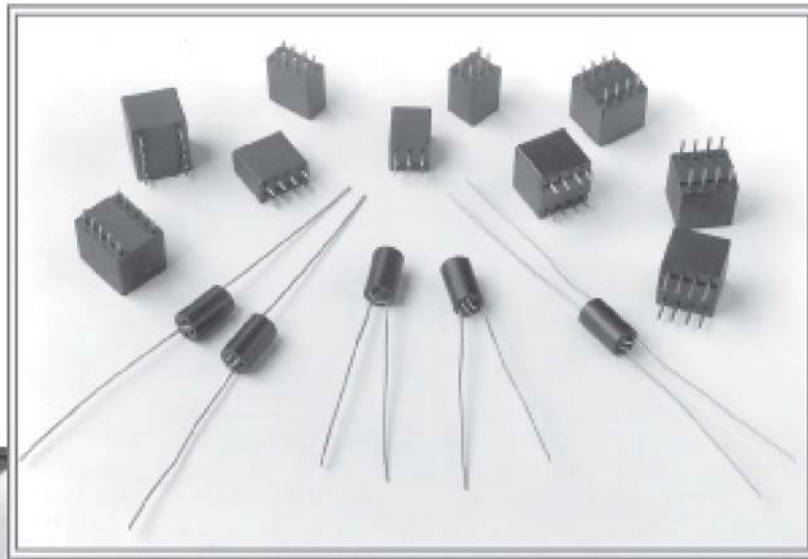

Fair-Rite Products Corp. PO Box 288, One Commercial Row, Wallkill, NY 12589-0288

Phone: (888) FAIR RITE / (845) 895-2055 • Fax: (888) FERRITE / (845) 895-2629 • Web: www.fair-rite.com
(888) 324-7748 (888) 337-7483 E-mail: ferrites@fair-rite.com

SUGGESTED REFLOW SOLDER PROFILE FOR LEAD-FREE COMPONENTS

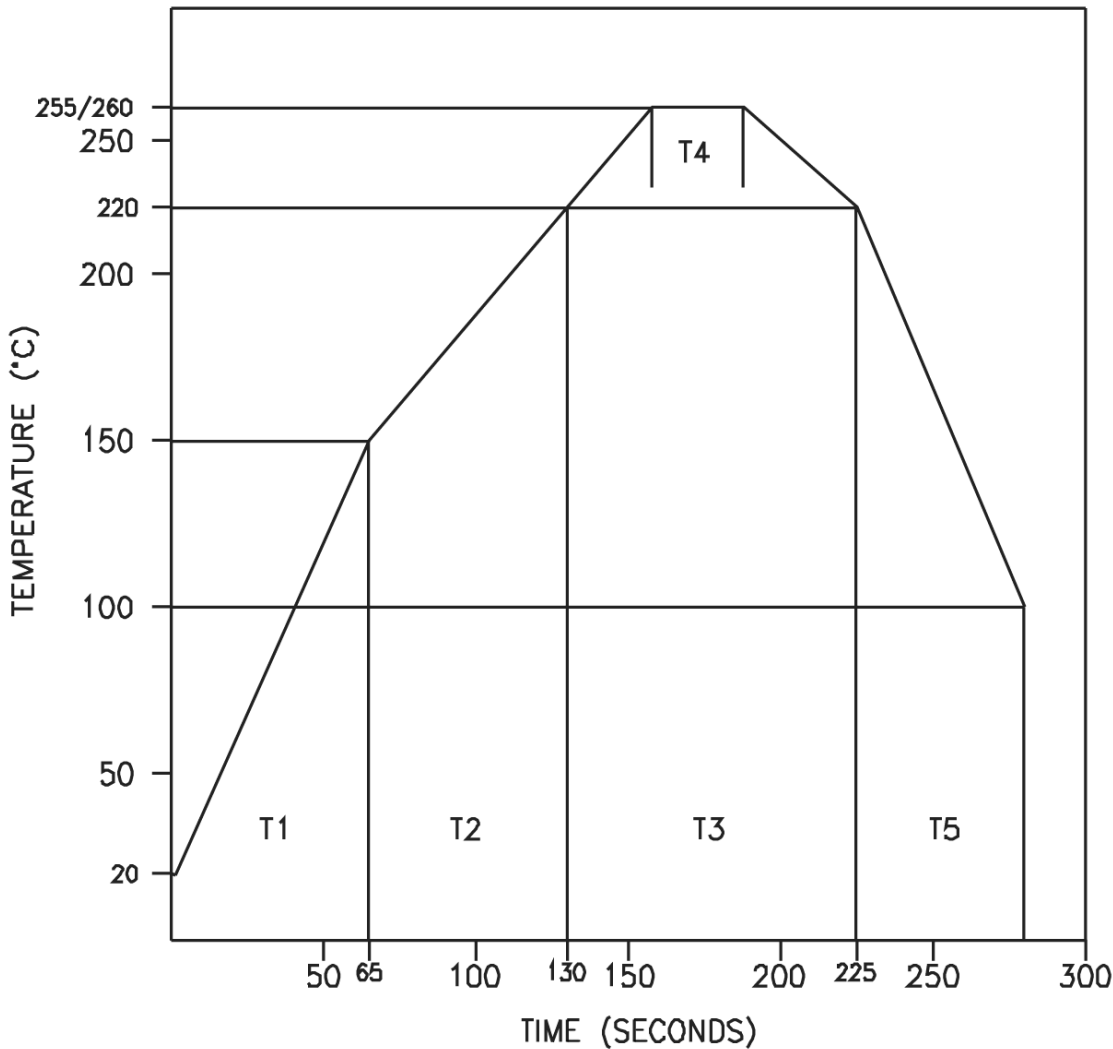

- | | |
|-------------------------|--------------------|
| T1 - Pre Heat | 50 - 80 Seconds |
| T2 - Soak Time | 60 - 90 Seconds |
| T3 - Time Above 220°C | 60 - 150 Seconds |
| T4 - Reflow Solder Time | 20 - 40 Seconds |
| T5 - Cool Down | 40 Seconds Minimum |

Times might be adjusted to accommodate component size

Fair-Rite offers a broad selection of ferrite EMI suppression beads with guaranteed minimum impedance specifications.

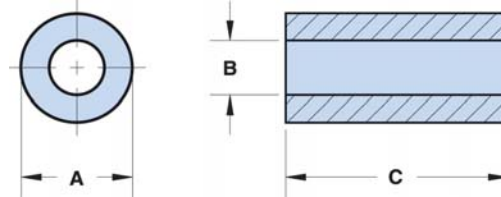

- Beads with a "1" as the last digit of the part number are not burnished. Parts that are burnished to break the sharp edges have a "2" as the last digit.
- Upon request beads can be supplied with a Parylene coating. The last digit of the Parylene coated part is a "4". The minimum coating thickness beads is 0.005 mm (0.0002").
- The column "H (Oe)" gives for each bead the calculated dc bias field in oersted for 1 turn and 1 ampere direct current. The actual dc H field in the application is this value of "H" times the actual NI (ampere-turn) product. For the effect of the dc bias on the impedance of the bead material, see figures 18-23 in the application note "How to choose Ferrite Components for EMI Suppression".
- Suppression beads are controlled for impedances only. Minimum impedance values are specified for the + marked frequencies. The minimum impedance is typically the listed impedance less 20%.
- Single turn impedance tests for 73 and 43 material beads are performed on the 4193A Vector Impedance Analyzer. The 61 material beads are tested on the 4291A RF Impedance Analyzer. **Beads are tested with the shortest practical wire length.**
- Performance curves for these suppression components are on our web site.
- For any EMI suppression bead requirement not listed here, feel free to contact our customer service for availability and pricing.
- The "C" dimension, the bead length, can be modified to suit specific applications.
- Our "Shield Bead Kit" (part number 0199000019) contains a selection of these beads.
- Explanation of Part Numbers: Digits 1&2 = product class, 3&4 = material grade and last digit 1= not burnished, 2 = burnished and 4 = Parylene coated.

EMI Suppression Beads



Quick Link: www.fair-rite.com/esb

Listed by frequency range and in ascending order of "B" dimension.

Legend

Dimensions (Top numbers are in millimeters, bottom numbers are in nominal inches.)

+ Test frequency

Lower Frequencies < 50 MHz (73 material)

Part Number	A	B	C	Wt. (g)	H (Oe)	Impedance (Ω)			
						1 MHz	5 MHz	10 MHz ⁺	25 MHz ⁺
2673901301	0.95 -0.05 0.036	0.45 +0.10 0.020	3.80 \pm 0.20 0.150	0.01	6.00	5.3	13	16	24
2673004601	1.10 -0.10 0.041	0.65 +0.10 0.028	4.10 -0.30 0.156	0.01	4.70	3.3	8.2	12.5	19
2673004701	1.45 -0.15 0.054	0.70 +0.10 0.029	2.30 \pm 0.15 0.090	0.01	4.00	3.1	7.6	12.5	17
2673030101	1.22 -0.13 0.045	0.80 +0.10 0.033	5.30 -0.45 0.200	0.01	4.10	3.5	8.6	11	17
2673025301	1.25 -0.10 0.047	0.80 +0.10 0.033	3.80 \pm 0.20 0.150	0.01	4.00	2.9	7.1	10	15
2673004801	2.10 -0.15 0.080	0.85 +0.10 0.034	2.90 -0.45 0.105	0.03	3.10	5.5	13.5	18	28
2673028602	2.13 -0.10 0.082	0.85 +0.10 0.034	5.60 \pm 0.15 0.220	0.07	2.70	13	30.5	38	50
2673012401	1.55 -0.10 0.059	0.95 +0.15 0.040	4.20 -0.25 0.160	0.02	3.30	3.5	8.6	11	19
2673002201	1.95 -0.02 0.072	1.05 +0.10 0.043	10.40 \pm 0.25 0.410	0.09	2.90	14	33.5	38	55
2673000501	2.00 -0.15 0.076	1.05 +0.10 0.043	1.65 -0.25 0.060	0.01	2.80	2.1	6.3	7.5	12
2673000201	2.00 -0.15 0.076	1.05 +0.10 0.043	3.80 \pm 0.25 0.150	0.04	2.80	5.2	12.5	18	27
2673000101	3.50 \pm 0.20 0.138	1.30 \pm 0.10 0.051	3.25 \pm 0.25 0.128	0.13	2.00	8.1	19.5	25	35
2673000301	3.50 \pm 0.20 0.138	1.30 \pm 0.10 0.051	6.00 \pm 0.25 0.236	0.24	2.00	15.5	37.5	57	63
2673000701	3.50 \pm 0.20 0.138	1.30 \pm 0.10 0.051	12.70 \pm 0.35 0.500	0.51	2.00	34.5	81.5	120	125
2673022401	5.10 \pm 0.25 0.200	1.45 +0.25 0.062	6.35 \pm 0.25 0.250	0.56	1.50	20	47.5	54	58
2673021801	5.10 \pm 0.25 0.200	1.45 +0.25 0.062	11.10 \pm 0.35 0.437	1.00	1.50	35.5	84	94	95
2673018001	2.85 \pm 0.10 0.112	1.65 +0.15 0.068	6.65 \pm 0.25 0.262	0.13	1.80	8.3	20	29	41
2673004901	2.85 \pm 0.10 0.112	1.65 +0.15 0.068	10.45 \pm 0.25 0.410	0.20	1.80	13.5	32.5	40	58
2673001601	3.55 \pm 0.15 0.140	1.65 +0.25 0.070	3.30 -0.40 0.122	0.11	1.60	5.1	12.5	16	24
2673015301	4.10 -0.25 0.156	1.80 \pm 0.15 0.071	6.85 \pm 0.25 0.270	0.32	1.50	14	34	41	54
2673000801	7.50 \pm 0.25 0.296	2.25 +0.25 0.094	7.55 \pm 0.25 0.297	1.40	1.00	23	55.5	48	45
2673200201	5.20 \pm 0.15 0.205	2.65 \pm 0.25 0.105	20.60 \pm 0.75 0.812	1.60	1.10	37	89	110	113
2673003201	5.60 -0.50 0.210	2.65 \pm 0.25 0.105	12.70 \pm 0.50 0.500	1.00	1.10	23.5	56.5	60	60
2673002402	9.65 \pm 0.25 0.380	5.00 \pm 0.20 0.197	5.05 -0.45 0.190	1.20	0.59	7.9	19	19	15

Fair-Rite Products Corp. PO Box 288, One Commercial Row, Wallkill, NY 12589-0288

EMI Suppression Beads



Quick Link: www.fair-rite.com/esb

Listed by frequency range and in ascending order of "B" dimension.

Broadband Frequencies 25-300 MHz (43 material)

Part Number	A	B	C	Wt. (g)	H (Oe)	Impedance (Ω)			
						10 MHz	25 MHz ⁺	100 MHz ⁺	250 MHz
2643004601	1.10 -0.10 0.041	0.65 +0.10 0.028	4.10 -0.30 0.156	0.10	4.70	9	12.5	31	39
2643004701	1.45 -0.15 0.054	0.70 +0.10 0.029	2.30 ±0.15 0.090	0.01	4.00	8	12.5	26	39
2643020501	1.65 ±0.025 0.065	0.85 +0.10 0.034	3.68 -0.25 0.140	0.02	3.40	12	17	31	47
2643004801	2.10 -0.15 0.080	0.85 +0.10 0.034	2.90 -0.45 0.105	0.03	3.10	12	18	31	47
2643002201	1.95 -0.20 0.072	1.05 +0.10 0.043	10.40 ±0.25 0.410	0.08	2.90	26	34	58	77
2643000501	2.00 -0.15 0.076	1.05 +0.10 0.043	1.65 -0.25 0.060	0.01	2.80	6	9	22	33
2643000201	2.00 -0.15 0.076	1.05 +0.10 0.043	3.80 ±0.25 0.150	0.03	2.80	12	16	31	46
2643000101	3.50 ±0.20 0.138	1.30 ±0.10 0.051	3.25 ±0.25 0.128	0.10	2.00	17	26	40	56
2643000301	3.50 ±0.20 0.138	1.30 ±0.10 0.051	6.00 ±0.25 0.236	0.18	2.00	29	46	60	83
2643000701	3.50 ±0.20 0.138	1.30 ±0.10 0.051	12.70 ±0.35 0.500	0.38	2.00	60	89	125	148
2643200101	5.10 ±0.25 0.200	1.45 +0.25 0.062	3.40 -0.45 0.125	0.19	1.50	19	30	41	61
2643022401	5.10 ±0.25 0.200	1.45 +0.25 0.062	6.35 ±0.25 0.250	0.38	1.50	36	55	82	97
2643021801	5.10 ±0.25 0.200	1.45 +0.25 0.062	11.10 ±0.35 0.437	0.67	1.50	62	96	131	151
2643001501	3.50 ±0.20 0.138	1.60 ±0.10 0.063	3.25 ±0.25 0.128	0.10	1.70	13	21	35	50
2643025601	3.50 ±0.20 0.138	1.60 ±0.10 0.063	6.00 ±0.25 0.236	0.18	1.70	23	38	55	70
2643023201	2.85 ±0.10 0.112	1.65 +0.15 0.068	3.75 ±0.25 0.147	0.06	1.80	10	15	30	43
2643013801	3.50 ±0.20 0.138	1.65 +0.25 0.070	4.05 ±0.25 0.160	0.12	1.60	14	24	38	52
2643001601	3.55 ±0.15 0.140	1.65 +0.25 0.070	3.30 -0.40 0.122	0.09	1.60	11	19	30	46
2643001301	3.55 ±0.15 0.140	1.65 +0.25 0.070	5.95 ±0.25 0.234	0.18	1.60	21	31	48	65
2643005701	5.10 ±0.25 0.200	2.30 ±0.20 0.090	12.70 ±0.35 0.500	0.81	1.20	49	78	120	123
2643000801	7.50 ±0.20 0.296	2.25 +0.25 0.094	7.55 ±0.25 0.297	1.00	1.00	42	63	92	109
2643300101	7.60 ±0.25 0.300	2.25 +0.25 0.094	15.10 ±0.75 0.595	2.10	1.00	83	115	200	195
2643003201	5.60 -0.50 0.210	2.65 ±0.25 0.105	12.70 ±0.50 0.500	0.87	1.10	42	63	88	110
2643250402	6.35 ±0.15 0.250	2.95 +0.45 0.125	12.70 ±0.50 0.500	1.20	0.91	43	69	102	111
2643250302	6.35 ±0.15 0.250	2.95 +0.45 0.125	15.90 ±0.50 0.625	1.50	0.91	53	85	122	132
2643250202	6.35 ±0.15 0.250	2.95 +0.45 0.125	25.40 ±0.75 1.000	2.50	0.91	83	135	200	196
2643375102	9.50 ±0.25 0.375	4.50 +0.75 0.192	6.35 ±0.35 0.250	1.40	0.60	21	35	50	66
2643375002	9.50 ±0.25 0.375	4.50 +0.75 0.192	14.50 ±0.60 0.570	3.10	0.60	47	78	115	119
2643006302	9.50 ±0.25 0.375	4.75 +0.30 0.193	10.40 ±0.25 0.410	2.20	0.60	34	53	80	92
2643023402	9.50 ±0.25 0.375	4.75 +0.30 0.193	15.90 ±0.45 0.625	3.40	0.60	51	83	120	127

Fair-Rite Products Corp. PO Box 288, One Commercial Row, Wallkill, NY 12589-0288

Phone: (888) FAIR RITE / (845) 895-2055 • Fax: (888) FERRITE / (845) 895-2629 • Web: www.fair-rite.com
 (888) 324-7748 (888) 337-7483 E -mail: ferrites@fair-rite.com

EMI Suppression Beads



Quick Link: www.fair-rite.com/esb

Listed by frequency range and in ascending order of "B" dimension.

Broadband Frequencies 25-300 MHz (43 material)

Part Number	A	B	C	Wt. (g)	H (Oe)	Impedance (Ω)			
						10 MHz	25 MHz ⁺	100 MHz ⁺	250 MHz
2643023002	9.50 \pm 0.25 0.375	4.75 +0.30 0.193	19.05 \pm 0.70 0.750	4.10	0.60	60	100	145	148
2643002402	9.65 \pm 0.25 0.380	5.00 \pm 0.20 0.197	5.05 -0.45 0.190	1.10	0.59	16	26	43	56
2643012702	9.65 \pm 0.25 0.380	6.35 \pm 0.15 0.250	7.35 \pm 0.25 0.290	1.30	0.51	15	24	38	55

Higher Frequencies 250-1000 MHz (61 material)

Part Number	A	B	C	Wt. (g)	H (Oe)	Impedance (Ω)			
						100 MHz	250 MHz ⁺	500 MHz ⁺	1000 MHz
2661000101	3.50 \pm 0.20 0.138	1.30 \pm 0.10 0.051	3.25 \pm 0.25 0.128	0.10	2.00	30	45	62	95
2661000301	3.50 \pm 0.20 0.138	1.30 \pm 0.10 0.051	6.00 \pm 0.25 0.236	0.18	2.00	54	82	103	120
2661000701	3.50 \pm 0.20 0.138	1.30 \pm 0.10 0.051	12.70 \pm 0.35 0.500	0.38	2.00	120	158	178	185
2661022401	5.10 \pm 0.25 0.200	1.45 +0.25 0.062	6.35 \pm 0.25 0.250	0.38	1.50	58	82	103	138
2661021801	5.10 \pm 0.25 0.200	1.45 +0.25 0.062	11.10 \pm 0.35 0.437	0.67	1.50	102	141	167	185
2661023801	5.10 \pm 0.25 0.200	1.45 +0.25 0.062	22.85 \pm 0.75 0.900	1.40	1.50	210	286	325	350
2661000801	7.50 \pm 0.25 0.296	2.25 +0.25 0.094	7.55 \pm 0.25 0.297	1.00	1.00	75	103	120	143
2661250402	6.35 \pm 0.15 0.250	2.95 +0.45 0.125	12.70 \pm 0.50 0.500	1.20	0.91	85	115	135	155
2661375102	9.50 \pm 0.25 0.375	4.50 +0.75 0.192	6.35 \pm 0.35 0.250	2.50	0.60	42	63	83	117

Fair-Rite Products Corp. PO Box 288, One Commercial Row, Walkill, NY 12589-0288

Ferrite suppression beads are supplied assembled on tinned copper wire for automated circuit board assembly.

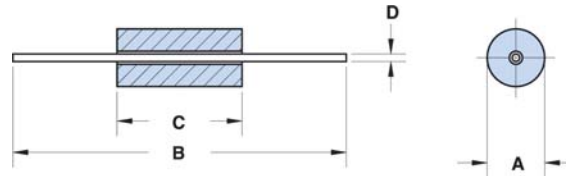

- Parts with a "2" as the last digit of the part number are supplied taped and reeled per IEC 60286-1 and EIA RS-296-F standards. Taped and reeled parts are supplied 4500 pieces on a 14" reel. Taping details: Component pitch 5 mm. Inside tape spacing 52.5 mm. Tape width 6 mm.
- Beads-on-leads can be supplied bulk packed. The last digit of bulk packed parts is a "1".
- Wires are oxygen free high conductivity copper with 100% matte tin plating over a nickel undercoating. The resistance of the wire is 3.5 mOhm for the 22 AWG and 2.2 mOhm for the 20 AWG wire.
- Beads-on-leads are controlled for impedances only. Minimum impedance values are specified for the + marked frequencies. The minimum impedance is typically the listed impedance less 20%. The impedances of the 73 & 43 beads-on-leads are measured on the 4193A Vector Impedance Analyzer. The 61 beads-on-leads are tested for impedance on the 4291A RF Impedance Analyzer.
- Performance curves for these suppression components are on our web site.
- For any bead-on lead requirement not listed here, feel free to contact our customer service group for availability and pricing.
- Our "Bead-on-Lead Suppression Kit" (part number 0199000028) is available for prototype evaluation.
- Explanation of Part Numbers: Digits 1&2 = product class, 3&4 = material grade and last digit 1 = bulk packed, 2 = taped and reeled.

Legend

Dimensions (Top numbers are in millimeters, bottom numbers are in nominal inches.)

* Test frequency

Lower Frequencies < 50 MHz (73 material)

Part Number	A	B	C	D	Wt. (g)	Impedance (Ω)				Reel Information		
						1 MHz	5 MHz	10 MHz ⁺	25 MHz ⁺	Tape Width mm	Pitch mm	Parts 14" Reel
2773001112	3.50 ±0.25 0.138	62.00 ±1.50 2.440	4.45 ±0.25 0.175	0.65 22 AWG	0.40	12	34	48	61	6	5	4500
2773001111	3.50 ±0.25 0.138	62.00 ±1.50 2.440	4.45 ±0.25 0.175	0.65 22 AWG	0.40	12	34	48	61	-	-	-
2773015112	3.50 ±0.25 0.138	62.00 ±1.50 2.440	5.25 ±0.25 0.206	0.65 22 AWG	0.40	17	43	55	68	6	5	4500
2773015111	3.50 ±0.25 0.138	62.00 ±1.50 2.440	5.25 ±0.25 0.206	0.65 22 AWG	0.40	17	43	55	68	-	-	-
2773005112	3.50 ±0.25 0.138	62.00 ±1.50 2.440	6.00 ±0.25 0.236	0.65 22 AWG	0.40	22	51	63	78	6	5	4500
2773005111	3.50 ±0.25 0.138	62.00 ±1.50 2.440	6.00 ±0.25 0.236	0.65 22 AWG	0.40	22	51	63	78	-	-	-
2773003112	3.50 ±0.25 0.138	62.00 ±1.50 2.440	6.70 ±0.25 0.263	0.65 22 AWG	0.50	26	59	70	86	6	5	4500
2773003111	3.50 ±0.25 0.138	62.00 ±1.50 2.440	6.70 ±0.25 0.263	0.65 22 AWG	0.50	26	59	70	86	-	-	-
2773004112	3.50 ±0.25 0.138	62.00 ±1.50 2.440	7.60 ±0.30 0.300	0.65 22 AWG	0.50	30	69	80	100	6	5	4500

Lower Frequencies < 50 MHz (73 material)

Part Number	A	B	C	D	Wt. (g)	Impedance (Ω)				Reel Information		
						1 MHz	5 MHz	10 MHz ⁺	25 MHz ⁺	Tape Width mm	Pitch mm	Parts 14" Reel
2773004111	3.50 \pm 0.25 0.138	62.00 \pm 1.50 2.440	7.60 \pm 0.30 0.300	0.65 22 AWG	0.50	30	69	80	100	-	-	-
2773002112	3.50 \pm 0.25 0.138	62.00 \pm 1.50 2.440	8.90 \pm 0.30 0.350	0.65 22 AWG	0.60	36	84	94	115	6	5	4500
2773002111	3.50 \pm 0.25 0.138	62.00 \pm 1.50 2.440	8.90 \pm 0.30 0.350	0.65 22 AWG	0.60	36	84	94	115	-	-	-
2773007112	3.50 \pm 0.25 0.138	62.00 \pm 1.50 2.440	9.50 \pm 0.30 0.374	0.65 22 AWG	0.60	38	90	110	115	6	5	4500
2773007111	3.50 \pm 0.25 0.138	62.00 \pm 1.50 2.440	9.50 \pm 0.30 0.374	0.65 22 AWG	0.60	38	90	110	115	-	-	-
2773008112	3.50 \pm 0.25 0.138	62.00 \pm 1.50 2.440	11.40 \pm 0.40 0.450	0.65 22 AWG	0.70	43	112	125	145	6	5	4500
2773008111	3.50 \pm 0.25 0.138	62.00 \pm 1.50 2.440	11.40 \pm 0.40 0.450	0.65 22 AWG	0.70	43	112	125	145	-	-	-
2773009112	3.50 \pm 0.25 0.138	62.00 \pm 1.50 2.440	13.80 \pm 0.50 0.545	0.65 22 AWG	0.70	46	138	151	170	6	5	4500
2773009111	3.50 \pm 0.25 0.138	62.00 \pm 1.50 2.440	13.80 \pm 0.50 0.545	0.65 22 AWG	0.70	46	138	151	170	-	-	-

Broadband Frequencies 25-300 MHz (43 material)

Part Number	A	B	C	D	Wt. (g)	Impedance (Ω)				Reel Information		
						10 MHz	25 MHz ⁺	100 MHz ⁺	250 MHz	Tape Width mm	Pitch mm	Parts 14" Reel
2743001112	3.50 \pm 0.25 0.138	62.00 \pm 1.50 2.440	4.45 \pm 0.25 0.175	0.65 22 AWG	0.40	31	49	68	65	6	5	4500
2743001111	3.50 \pm 0.25 0.138	62.00 \pm 1.50 2.440	4.45 \pm 0.25 0.175	0.65 22 AWG	0.40	31	49	68	65	-	-	-
2743015112	3.50 \pm 0.25 0.138	62.00 \pm 1.50 2.440	5.25 \pm 0.25 0.206	0.65 22 AWG	0.40	36	54	82	78	6	5	4500
2743015111	3.50 \pm 0.25 0.138	62.00 \pm 1.50 2.440	5.25 \pm 0.25 0.206	0.65 22 AWG	0.40	36	54	82	78	-	-	-
2743005112	3.50 \pm 0.25 0.138	62.00 \pm 1.50 0.244	6.00 \pm 0.25 0.236	0.65 22 AWG	0.40	40	60	91	90	6	5	4500
2743005111	3.50 \pm 0.25 0.138	62.00 \pm 1.50 0.244	6.00 \pm 0.25 0.236	0.65 22 AWG	0.40	40	60	91	90	-	-	-
2743003112	3.50 \pm 0.25 0.138	62.00 \pm 1.50 0.244	6.70 \pm 0.25 0.263	0.65 22 AWG	0.50	44	65	100	101	6	5	4500
2743003111	3.50 \pm 0.25 0.138	62.00 \pm 1.50 0.244	6.70 \pm 0.25 0.263	0.65 22 AWG	0.50	44	65	100	101	-	-	-
2743004112	3.50 \pm 0.25 0.138	62.00 \pm 1.50 2.440	7.60 \pm 0.30 0.300	0.65 22 AWG	0.50	50	75	110	115	6	5	4500
2743004111	3.50 \pm 0.25 0.138	62.00 \pm 1.50 2.440	7.60 \pm 0.30 0.300	0.65 22 AWG	0.50	50	75	110	115	-	-	-
2743002112	3.50 \pm 0.25 0.138	62.00 \pm 1.50 2.440	8.90 \pm 0.30 0.350	0.65 22 AWG	0.60	57	88	133	134	6	5	4500
2743002111	3.50 \pm 0.25 0.138	62.00 \pm 1.50 2.440	8.90 \pm 0.30 0.350	0.65 22 AWG	0.60	57	88	133	134	-	-	-
2743007112	3.50 \pm 0.25 0.138	62.00 \pm 1.50 2.440	9.50 \pm 0.30 0.374	0.65 22 AWG	0.60	61	96	150	143	6	5	4500
2743007111	3.50 \pm 0.25 0.138	62.00 \pm 1.50 2.440	9.50 \pm 0.30 0.374	0.65 22 AWG	0.60	61	96	150	143	-	-	-
2743008112	3.50 \pm 0.25 0.138	62.00 \pm 1.50 2.440	11.40 \pm 0.40 0.450	0.65 22 AWG	0.70	72	116	180	168	6	5	4500
2743008111	3.50 \pm 0.25 0.138	62.00 \pm 1.50 2.440	11.40 \pm 0.40 0.450	0.65 22 AWG	0.70	72	116	180	168	-	-	-

Broadband Frequencies 25-300 MHz (43 material)

Part Number	A	B	C	D	Wt. (g)	Impedance (Ω)				Reel Information		
						10 MHz	25 MHz ⁺	100 MHz ⁺	250 MHz	Tape Width mm	Pitch mm	Parts 14" Reel
2743009112	3.50 \pm 0.25 0.138	62.00 \pm 1.50 2.440	13.80 \pm 0.50 0.545	0.65 22 AWG	0.70	86	143	220	196	6	5	4500
2743009111	3.50 \pm 0.25 0.138	62.00 \pm 1.50 2.440	13.80 \pm 0.50 0.545	0.65 22 AWG	0.70	86	143	220	196	-	-	-
2743012201	9.80 \pm 0.30 0.385	62.00 \pm 1.50 2.440	11.40 \pm 0.40 0.449	0.80 20 AWG	4.50	121	193	271	253	-	-	-
2743013211	9.80 \pm 0.30 0.385	62.00 \pm 1.50 2.440	14.00 \pm 0.50 0.550	0.80 20 AWG	5.50	147	235	331	281	-	-	-
2743014221	9.80 \pm 0.30 0.385	62.00 \pm 1.50 2.440	16.50 \pm 0.50 0.650	0.80 20 AWG	6.50	173	280	391	296	-	-	-

Higher Frequencies 250-1000 MHz (61 material)

Part Number	A	B	C	D	Wt. (g)	Impedance (Ω)				Reel Information		
						100 MHz	250 MHz ⁺	500 MHz ⁺	1000 MHz	Tape Width mm	Pitch mm	Parts 14" Reel
2761001112	3.50 \pm 0.25 0.138	62.00 \pm 1.50 2.440	4.45 \pm 0.25 0.175	0.65 22 AWG	0.40	52	72	83	90	6	5	4500
2761001111	3.50 \pm 0.25 0.138	62.00 \pm 1.50 2.440	4.45 \pm 0.25 0.175	0.65 22 AWG	0.40	52	72	83	90	-	-	-
2761015112	3.50 \pm 0.25 0.138	62.00 \pm 1.50 2.440	5.25 \pm 0.25 0.206	0.65 22 AWG	0.40	62	85	97	105	6	5	4500
2761015111	3.50 \pm 0.25 0.138	62.00 \pm 1.50 2.440	5.25 \pm 0.25 0.206	0.65 22 AWG	0.40	62	85	97	105	-	-	-
2761004112	3.50 \pm 0.25 0.138	62.00 \pm 1.50 2.440	7.60 \pm 0.30 0.300	0.65 22 AWG	0.50	89	121	138	148	6	5	4500
2761004111	3.50 \pm 0.25 0.138	62.00 \pm 1.50 2.440	7.60 \pm 0.30 0.300	0.65 22 AWG	0.50	89	121	138	148	-	-	-
2761002112	3.50 \pm 0.25 0.138	62.00 \pm 1.50 2.440	8.90 \pm 0.30 0.350	0.65 22 AWG	0.60	105	142	161	171	6	5	4500
2761002111	3.50 \pm 0.25 0.138	62.00 \pm 1.50 2.440	8.90 \pm 0.30 0.350	0.65 22 AWG	0.60	105	142	161	171	-	-	-
2761007112	3.50 \pm 0.25 0.138	62.00 \pm 1.50 2.440	9.50 \pm 0.30 0.374	0.65 22 AWG	0.60	112	151	171	182	6	5	4500
2761007111	3.50 \pm 0.25 0.138	62.00 \pm 1.50 2.440	9.50 \pm 0.30 0.374	0.65 22 AWG	0.60	112	151	171	182	-	-	-
2761008112	3.50 \pm 0.25 0.138	62.00 \pm 1.50 2.440	11.40 \pm 0.40 0.450	0.65 22 AWG	0.70	134	181	204	217	6	5	4500
2761008111	3.50 \pm 0.25 0.138	62.00 \pm 1.50 2.440	11.40 \pm 0.40 0.450	0.65 22 AWG	0.70	134	181	204	217	-	-	-
2761009112	3.50 \pm 0.25 0.138	62.00 \pm 1.50 2.440	13.80 \pm 0.50 0.545	0.65 22 AWG	0.70	162	218	246	261	6	5	4500
2761009111	3.50 \pm 0.25 0.138	62.00 \pm 1.50 2.440	13.80 \pm 0.50 0.545	0.65 22 AWG	0.70	162	218	246	261	-	-	-

PC Beads (Through Hole)



Quick Link: www.fair-rite.com/pcb

Multiple single turn or multi-turn printed circuit EMI suppression beads are available in two Fair-Rite materials. The broadband 44 material and in the high frequency 52 material grade.

- PC Beads can be supplied with lower component heights "C". Also, the wire length "F" can be modified to specific requirements.
- Wires are oxygen free high conductivity copper with 100% matte tin plating over a nickel undercoating. Wires on top of the beads are covered with a layer of epoxy.
- PC Beads are controlled for impedance only. Minimum impedance values are specified for the + marked frequencies. The minimum impedance is typically the listed impedance less 20%.
- The PC Beads in 44 material are measured on the 4193A Vector Impedance Analyzer. The 52 PC Beads are tested for impedance on the 4291A RF Impedance Analyzer.
- Recommended operating and storage temperature for the PC Beads is -55 °C to +125 °C.
- Performance curves for these suppression components are on our web site.
- Explanation of Part Numbers: Digits 1&2 = product class, 3&4 = material grade and last digit 1 = standard wire length 2.4 mm (0.095") minimum, 2 = wire length 3.1 mm (0.122") minimum.

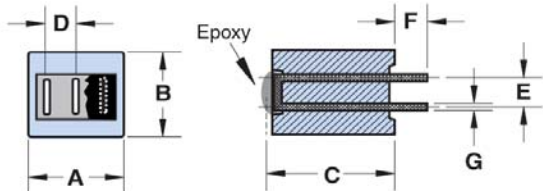

Figure 1

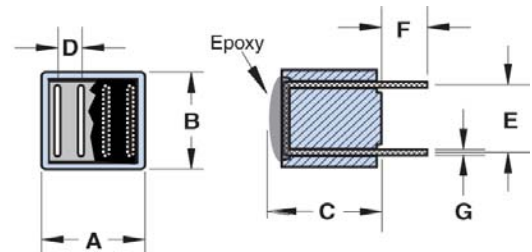

Figure 3

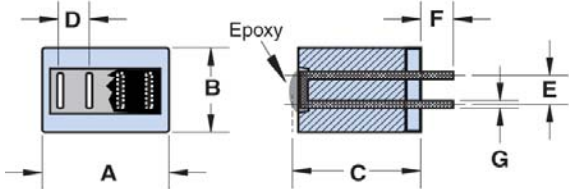

Figure 2

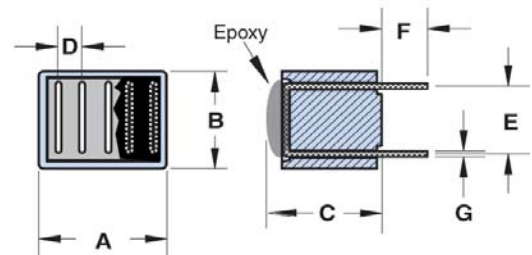

Figure 4

Typical Multi Turn Printed Circuit Board Layouts

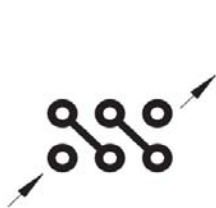

Figure 1A:
3 Turn winding
for parts in Fig.1

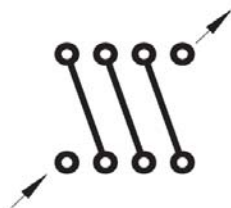

Figure 3A:
4 Turn turn winding
for parts in Fig. 3.

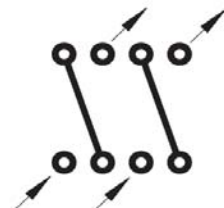

Figure 3B:
2 x 2 Turn winding
for parts in Fig. 3.

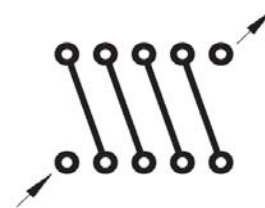

Figure 4A:
5 Turn winding
for parts in Fig. 4.

Fair-Rite Products Corp. PO Box 288, One Commercial Row, Wallkill, NY 12589-0288

Phone: (888) FAIR RITE / (845) 895-2055 • Fax: (888) FERRITE / (845) 895-2629 • Web: www.fair-rite.com
(888) 324-7748 (888) 337-7483 E -mail: ferrites@fair-rite.com

PC Beads (Through Hole)



Quick Link: www.fair-rite.com/pcb

Legend

Dimensions (Top numbers are in millimeters, bottom numbers are in nominal inches.)

* Test frequency

Broadband Frequencies 10-300 MHz (44 material)

Part Number	Fig.	A	B	C	D	E	F	G	Wt. (g)	Impedance (Ω)			
										10 MHz	25 MHz ⁺	100 MHz ⁺	250 MHz
2944776101	1	8.00 -0.35 0.308	7.60 -0.50 0.290	11.80 Max 0.464 Max	2.54 ±0.10 0.100	2.54 ±0.10 0.100	2.40 Min 0.095 Min	0.65 22 AWG	2.60	115	188	288	305
2944778101	2	11.20 -0.50 0.430	5.75 -0.50 0.216	11.80 Max 0.464 Max	2.54 ±0.10 0.100	2.54 ±0.10 0.100	2.40 Min 0.095 Min	0.65 22 AWG	2.70	115	188	288	305
2944778301	3	11.20 -0.50 0.430	11.20 -0.50 0.430	11.80 Max 0.464 Max	2.54 ±0.10 0.100	7.60 ±0.20 0.300	2.40 Min 0.095 Min	0.65 22 AWG	6.00	142	219	338	335
2944770301	4	13.45 ±0.25 0.530	11.20 -0.50 0.430	11.80 Max 0.464 Max	2.54 ±0.10 0.100	7.60 ±0.20 0.300	2.40 Min 0.095 Min	0.65 22 AWG	7.40	142	219	338	335

Higher Frequencies 250-1000 MHz (52 material)

Part Number	Fig.	A	B	C	D	E	F	G	Wt. (g)	Impedance (Ω)			
										100 MHz	250 MHz ⁺	500 MHz ⁺	1000 MHz
2952776101	1	8.00 -0.35 0.308	7.60 -0.50 0.290	11.80 Max 0.464 Max	2.54 ±0.10 0.100	2.54 ±0.10 0.100	2.40 Min 0.095 Min	0.65 22 AWG	2.60	270	380	345	250
2952778301	3	11.20 -0.50 0.430	11.20 -0.50 0.430	11.80 Max 0.464 Max	2.54 ±0.10 0.100	7.60 ±0.20 0.300	2.40 Min 0.095 Min	0.65 22 AWG	6.00	320	460	395	300

Fair-Rite Products Corp. PO Box 288, One Commercial Row, Wallkill, NY 12589-0288

Phone: (888) FAIR RITE / (845) 895-2055 • Fax: (888) FERRITE / (845) 895-2629 • Web: www.fair-rite.com
 (888) 324-7748 (888) 337-7483 E -mail: ferrites@fair-rite.com

Quick Link: www.fair-rite.com/wb

Six and eleven hole beads, in two NiZn materials, are available both as beads (product class 26) and wound with tinned copper wire in several winding configurations (product class 29).

- Parts with a “1” as the last digit of the part number are supplied bulk packed. Wound beads with part numbers 29--666631 and 29--666651 can be supplied radially taped and reeled per IEC 60286-1 and EIA 468-B standards. For these taped and reeled wound beads the last digit of the part number is a “4”. Taped and reeled wound beads are supplied 500 pieces on a 13” reel.
- Wire used for winding is oxygen free high conductivity copper with 100% matte tin plating over a nickel undercoating.
- Beads are controlled for impedance limits only. Minimum impedance values are specified for the + marked frequencies. The minimum impedance is typically the listed impedance less 20%. The 44 material beads and wound beads are tested on the 4193A Vector Impedance Meter. The 61 material parts on the 4291A RF Impedance Analyzer.
- Recommended storage temperature and operating temperature is -55 °C to 125 °C
- Performance curves for these suppression components are on our web site.
- For any wound bead requirement not listed in here, please contact our customer service group for availability and pricing.
- Explanation of Part Numbers: Digits 1&2 = product class, 3&4 = material grade and last digit 1 = bulk packed, 4 = taped and reeled.

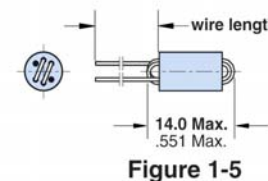
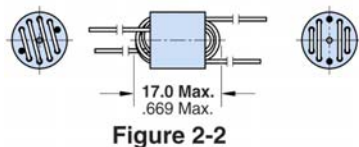
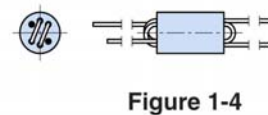
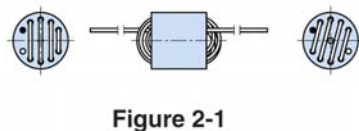
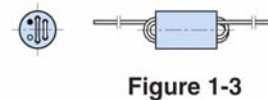
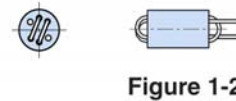
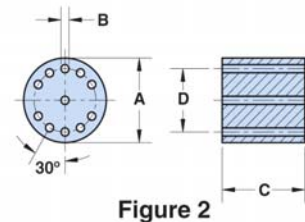
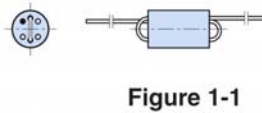
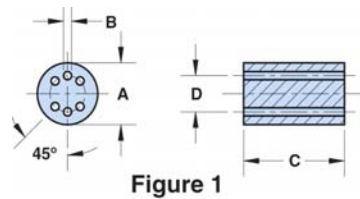

Wound Beads



Quick Link: www.fair-rite.com/wb

Legend

Dimensions (Top numbers are in millimeters, bottom numbers are in nominal inches.)

* Test frequency

A1/2 turn is defined as a single pass through a hole.

Beads

Part Number	Fig.	Turns Tested	A	B	C	D	Wt. (g)	Impedance (Ω)			
								10 MHz ⁺	50 MHz ⁺	100 MHz ⁺	200 MHz ⁺
2644666611	1	1½	6.00 ±0.25 0.236	0.75 +0.15 0.032	10.00 ±0.25 0.394	3.50 Ref 0.138 Ref	1.20	213	400	470	–
2661666611	1	1½	6.00 ±0.25 0.236	0.75 +0.15 0.032	10.00 ±0.25 0.394	3.50 Ref 0.138 Ref	1.20	–	280	380	510
2644777711	2	2½	10.00 ±0.25 0.394	0.90 +0.15 0.038	10.00 ±0.25 0.394	7.50 Ref 0.295 Ref	3.30	375	905	500	–

Broadband Frequencies 1-200 MHz (44 material)

Row #	Part Number	Fig.	A	B	C	D	Wt. (g)	Reel Information	
								Pitch mm	Parts 13" Reel
(1)	2944666661	1-1	6.00 ±0.25 0.236	0.75 +0.15 0.032	10.00 ±0.25 0.394	3.50 Ref 0.138 Ref	1.30	-	-
(2)	2944666651	1-2	6.00 ±0.25 0.236	0.75 +0.15 0.032	10.00 ±0.25 0.394	3.50 Ref 0.138 Ref	1.30	-	-
(3)	2944666654	1-2	6.00 ±0.25 0.236	0.75 +0.15 0.032	10.00 ±0.25 0.394	3.50 Ref 0.138 Ref	1.30	12.7	500
(4)	2944666671	1-3	6.00 ±0.25 0.236	0.75 +0.15 0.032	10.00 ±0.25 0.394	3.50 Ref 0.138 Ref	1.40	-	-
(5)	2944666681	1-4	6.00 ±0.25 0.236	0.75 +0.15 0.032	10.00 ±0.25 0.394	3.50 Ref 0.138 Ref	1.40	-	-
(6)	2944666631	1-5	6.00 ±0.25 0.236	0.75 +0.15 0.032	10.00 ±0.25 0.394	3.50 Ref 0.138 Ref	1.40	-	-
(7)	2944666634	1-5	6.00 ±0.25 0.236	0.75 +0.15 0.032	10.00 ±0.25 0.394	3.50 Ref 0.138 Ref	1.40	12.7	500
(8)	2944777741	2-1	10.00 ±0.25 0.394	0.90 +0.15 0.038	10.00 ±0.25 0.394	7.50 Ref 0.295 Ref	3.80	-	-
(9)	2944777721	2-2	10.00 ±0.25 0.394	0.90 +0.15 0.038	10.00 ±0.25 0.394	7.50 Ref 0.295 Ref	3.90	-	-

Table Continued ...

Row #	Part Number	Turns	Wire Size	1st Wire Length	2nd Wire Length	Impedance (Ω)				
						1 MHz	10 MHz ⁺	50 MHz ⁺	100 MHz ⁺	200 MHz
(1)	2944666661	1½	0.53 24 AWG	38.0 ±3.0 1.500	–	45	213	400	470	380
(2)	2944666651	2	0.53 24 AWG	38.0 ±3.0 1.500	–	58	300	650	600	415
(3)	2944666654	2	0.53 24 AWG	38.0 ±3.0 1.500	–	58	300	650	600	415
(4)	2944666671	2½	0.53 24 AWG	38.0 ±3.0 1.500	–	87	400	850	725	410
(5)	2944666681	2 x 1½	0.53 24 AWG	38.0 ±3.0 1.500	28.0 ±3.0 1.102	45	213	400	470	380
(6)	2944666631	3	0.53 24 AWG	38.0 ±3.0 1.500	–	115	500	1000	690	400

Fair-Rite Products Corp. PO Box 288, One Commercial Row, Wallkill, NY 12589-0288

Phone: (888) FAIR RITE / (845) 895-2055 • Fax: (888) FERRITE / (845) 895-2629 • Web: www.fair-rite.com
(888) 324-7748 (888) 337-7483 E-mail: ferrites@fair-rite.com

Quick Link: www.fair-rite.com/wb

Table Continued ...

Row #	Part Number	Turns	Wire Size	1st Wire Length	2nd Wire Length	Impedance (Ω)				
						1 MHz	10 MHz ⁺	50 MHz ⁺	100 MHz ⁺	200 MHz
(7)	2944666634	3	0.53 24 AWG	38.0 \pm 3.0 1.500	–	115	500	1000	690	400
(8)	2944777741	4½	0.65 22 AWG	38.0 \pm 3.0 1.500	–	150	815	1250	500	375
(9)	2944777721	2 x 2½	0.65 22 AWG	38.0 \pm 3.0 1.500	28.0 \pm 3.0 1.102	45	375	905	500	400

Higher Frequencies 50-500 MHz (61 material)

Row #	Part Number	Fig.	A	B	C	D	Wt. (g)	Reel Information	
								Pitch mm	Parts 13" Reel
(10)	2961666661	1-1	6.00 \pm 0.25 0.236	0.75 \pm 0.15 0.032	10.00 \pm 0.25 0.394	3.50 Ref 0.138 Ref	1.30	-	-
(11)	2961666651	1-2	6.00 \pm 0.25 0.236	0.75 \pm 0.15 0.032	10.00 \pm 0.25 0.394	3.50 Ref 0.138 Ref	1.30	-	-
(12)	2961666654	1-2	6.00 \pm 0.25 0.236	0.75 \pm 0.15 0.032	10.00 \pm 0.25 0.394	3.50 Ref 0.138 Ref	1.30	12.7	500
(13)	2961666671	1-3	6.00 \pm 0.25 0.236	0.75 \pm 0.15 0.032	10.00 \pm 0.25 0.394	3.50 Ref 0.138 Ref	1.40	-	-
(14)	2961666681	1-4	6.00 \pm 0.25 0.236	0.75 \pm 0.15 0.032	10.00 \pm 0.25 0.394	3.50 Ref 0.138 Ref	1.40	-	-
(15)	2961666631	1-5	6.00 \pm 0.25 0.236	0.75 \pm 0.15 0.032	10.00 \pm 0.25 0.394	3.50 Ref 0.138 Ref	1.40	-	-
(16)	2961666634	1-5	6.00 \pm 0.25 0.236	0.75 \pm 0.15 0.032	10.00 \pm 0.25 0.394	3.50 Ref 0.138 Ref	1.40	12.7	500

Table Continued ...

Row #	Part Number	Turns	Wire Size	1st Wire Length	2nd Wire Length	Impedance (Ω)				
						10 MHz	50 MHz ⁺	100 MHz ⁺	200 MHz ⁺	400 MHz
(10)	2961666661	1½	0.53 24 AWG	38.0 \pm 3.0 1.500	–	75	280	380	510	600
(11)	2961666651	2	0.53 24 AWG	38.0 \pm 3.0 1.500	–	100	400	560	760	700
(12)	2961666654	2	0.53 24 AWG	38.0 \pm 3.0 1.500	–	100	400	560	760	700
(13)	2961666671	2½	0.53 24 AWG	38.0 \pm 3.0 1.500	–	150	560	780	960	600
(14)	2961666681	2 x 1½	0.53 24 AWG	38.0 \pm 3.0 1.500	28.0 \pm 3.0 1.102	75	280	380	510	600
(15)	2961666631	3	0.53 24 AWG	38.0 \pm 3.0 1.500	–	175	700	1000	1100	625
(16)	2961666634	3	0.53 24 AWG	38.0 \pm 3.0 1.500	–	175	700	1000	1100	625

Quick Link: www.fair-rite.com/mac

Multi-aperture cores are used in suppression applications and in balun (balance-unbalance) and other broadband transformers. They are also employed in airbag designs to prevent accidental activation.



Figure 1

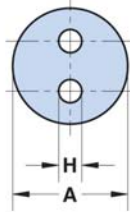
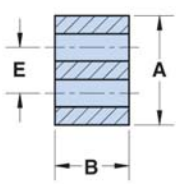

Figure 2

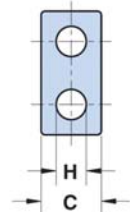
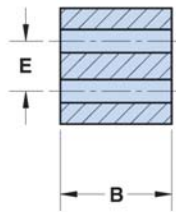
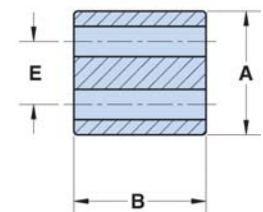

Figure 3



- All multi-aperture cores are supplied burnished.
- Multi-aperture cores in 73 and 43 materials are controlled for impedance only. The 61 NiZn material is controlled for both impedance and AL value. The high frequency 67 material is controlled for AL value. Minimum impedance values are specified for the + marked frequencies. The minimum impedance is typically the listed impedance less 20%.
- Multi-aperture cores in 73 and 43 material are measured for impedance on the 4193A Vector Impedance Analyzer. The 61 and 67 multi-aperture cores are tested on the 4291A Impedance Analyzer. All impedance measurements are performed with a single turn to both holes, **using the shortest practical wire length**.
- The 61 and 67 material multi-hole beads are tested for AL value. The test frequency is 10 kHz at < 10 gauss. The test winding is five turns wound through both holes.
- Performance curves for these suppression components are on our web site.
- For any multi-aperture requirement not listed here, feel free to contact our customer service group for availability and pricing.
- Our "Multi-Aperture Core Kit" (part number 0199000036) is available for prototype evaluation.
- Explanation of Part Numbers: Digits 1&2 = product class, 3&4 = material grade last digit 2 = burnished.

Multi-Aperture Cores



Quick Link: www.fair-rite.com/mac

Legend

Dimensions (Top numbers are in millimeters, bottom numbers are in nominal inches.)

+ Test frequency

Suppression Applications for Lower Frequencies < 50 MHz (73 material)

Part Number	Fig.	A	B	C	E	H	Wt. (g)	Impedance (Ω)	
								10 MHz	25 MHz ⁺
2873002302	1	3.45 ±0.25 0.136	2.35 ±0.25 0.093	2.00 ±0.15 0.079	1.45 ±0.10 0.057	0.75 +0.25 0.034	0.10	35	44
2873002702	1	7.00 ±0.25 0.276	3.10 ±0.25 0.122	4.20 -0.25 0.160	2.90 ±0.10 0.114	1.70 +0.20 0.071	0.30	28	38
2873002402	1	7.00 ±0.25 0.276	6.20 ±0.25 0.244	4.20 -0.25 0.160	2.90 ±0.10 0.114	1.70 +0.20 0.071	0.50	80	75
2873001802	2	6.35 ±0.25 0.250	6.15 ±0.25 0.242	–	2.75 ±0.20 0.108	1.10 +0.30 0.050	0.80	115	106
2873001702	2	6.35 ±0.25 0.250	12.00 ±0.35 0.471	–	2.75 ±0.20 0.108	1.10 +0.30 0.050	1.60	200	200
2873001502	1	13.30 ±0.60 0.525	6.60 ±0.25 0.260	7.50 ±0.35 0.295	5.70 ±0.25 0.225	3.80 ±0.25 0.150	1.70	57	50
2873000302	1	13.30 ±0.60 0.525	10.30 ±0.30 0.407	7.50 ±0.35 0.295	5.70 ±0.25 0.225	3.80 ±0.25 0.150	2.60	94	75
2873000102	1	13.30 ±0.60 0.525	13.40 ±0.30 0.528	7.50 ±0.35 0.295	5.70 ±0.25 0.225	3.80 ±0.25 0.150	3.50	127	93
2873000202	1	13.30 ±0.60 0.525	14.35 ±0.50 0.565	7.50 ±0.35 0.295	5.70 ±0.25 0.225	3.80 ±0.25 0.150	3.70	125	106
2873006802	1	13.30 ±0.60 0.525	27.00 ±0.75 1.062	7.50 ±0.35 0.295	5.70 ±0.25 0.225	3.80 ±0.25 0.150	7.00	195	180

Suppression Applications for Broadband Frequencies 20-300 MHz (43 material)

Part Number	Fig.	A	B	C	E	H	Wt. (g)	Impedance (Ω)	
								25 MHz	100 MHz ⁺
2843002302	1	3.45 ±0.25 0.136	2.35 ±0.25 0.093	2.00 ±0.15 0.079	1.45 ±0.10 0.057	0.75 +0.25 0.034	0.10	29	44
2843002702	1	7.00 ±0.25 0.276	3.10 ±0.25 0.122	4.20 -0.25 0.160	2.90 ±0.10 0.114	1.70 +0.20 0.071	0.30	37	50
2843002402	1	7.00 ±0.25 0.276	6.20 ±0.25 0.244	4.20 -0.25 0.160	2.90 ±0.10 0.114	1.70 +0.20 0.071	0.50	74	100
2843001802	2	6.35 ±0.25 0.250	6.15 ±0.25 0.242	–	2.75 ±0.20 0.108	1.10 +0.30 0.050	0.80	100	131
2843001502	1	13.30 ±0.60 0.525	6.60 ±0.25 0.260	7.50 ±0.35 0.295	5.70 ±0.25 0.225	3.80 ±0.25 0.150	1.70	59	88
2843000302	1	13.30 ±0.60 0.525	10.30 ±0.30 0.407	7.50 ±0.35 0.295	5.70 ±0.25 0.225	3.80 ±0.25 0.150	2.60	104	130
2843000102	1	13.30 ±0.60 0.525	13.40 ±0.30 0.528	7.50 ±0.35 0.295	5.70 ±0.25 0.225	3.80 ±0.25 0.150	3.50	122	175
2843000202	1	13.30 ±0.60 0.525	14.35 ±0.50 0.565	7.50 ±0.35 0.295	5.70 ±0.25 0.225	3.80 ±0.25 0.150	3.70	123	180
2843006802	1	13.30 ±0.60 0.525	27.00 ±0.75 1.062	7.50 ±0.35 0.295	5.70 ±0.25 0.225	3.80 ±0.25 0.150	7.00	219	300
2843010402	3	19.45 ±0.40 0.765	12.70 ±0.50 0.500	9.50 ±0.25 0.375	9.90 ±0.25 0.390	4.75 ±0.20 0.187	7.50	135	200
2843010302	3	19.45 ±0.40 0.765	25.40 ±0.70 1.000	9.50 ±0.25 0.375	9.90 ±0.25 0.390	4.75 ±0.20 0.187	18.00	295	400
2843009902	3	28.70 ±0.60 1.130	28.70 ±0.70 1.130	14.25 ±0.30 0.560	14.00 ±0.30 0.550	6.35 ±0.15 0.250	48.00	380	500

Fair-Rite Products Corp. PO Box 288, One Commercial Row, Wallkill, NY 12589-0288

Phone: (888) FAIR RITE / (845) 895-2055 • Fax: (888) FERRITE / (845) 895-2629 • Web: www.fair-rite.com
 (888) 324-7748 (888) 337-7483 E -mail: ferrites@fair-rite.com

Quick Link: www.fair-rite.com/mac

Suppression Applications for Higher Frequencies > 250 MHz (61 material) Broadband and Inductive Designs 1- 40 MHz (61 material)

Part Number	Fig.	A	B	C	E	H	Wt. (g)	Impedance (Ω)		A_L (nH)
								100 MHz	250 MHz ⁺	
2861002302	1	3.45 ±0.25 0.136	2.35 ±0.25 0.093	2.00 ±0.15 0.079	1.45 ±0.10 0.057	0.75 +0.25 0.034	0.10	35	48	60 Min
2861002702	1	7.00 ±0.25 0.276	3.10 ±0.25 0.122	4.20 -0.25 0.160	2.90 ±0.10 0.114	1.70 +0.20 0.071	0.30	44	63	80 Min
2861002402	1	7.00 ±0.25 0.276	6.20 ±0.25 0.244	4.20 -0.25 0.160	2.90 ±0.10 0.114	1.70 +0.20 0.071	0.50	80	118	160 Min
2861001702	2	6.35 ±0.25 0.250	12.00 ±0.35 0.471	-	2.75 ±0.20 0.108	1.10 +0.30 0.050	1.60	210	275	440 Min
2861001502	1	13.30 ±0.60 0.525	6.60 ±0.25 0.260	7.50 ±0.35 0.295	5.70 ±0.25 0.225	3.80 ±0.25 0.150	1.70	90	115	145 Min
2861000302	1	13.30 ±0.60 0.525	10.30 ±0.30 0.407	7.50 ±0.35 0.295	5.70 ±0.25 0.225	3.80 ±0.25 0.150	2.60	150	200	230 Min
2861000102	1	13.30 ±0.60 0.525	13.40 ±0.30 0.528	7.50 ±0.35 0.295	5.70 ±0.25 0.225	3.80 ±0.25 0.150	3.50	160	225	300 Min
2861000202	1	13.30 ±0.60 0.525	14.35 ±0.50 0.565	7.50 ±0.35 0.295	5.70 ±0.25 0.225	3.80 ±0.25 0.150	3.70	150	190	320 Min
2861006802	1	13.30 ±0.60 0.525	27.00 ±0.75 1.062	7.50 ±0.35 0.295	5.70 ±0.25 0.225	3.80 ±0.25 0.150	7.00	300	425	600 Min
2861010002	3	30.20 ±0.60 1.190	28.70 ±0.70 1.130	15.00 ±0.40 0.590	14.60 ±0.40 0.575	6.80 ±0.2 0.268	46.00	510	625	800 Min

Broadband and Inductive Designs 10-100 MHz (67 material)

Part Number	Fig.	A	B	C	E	H	Wt. (g)	A_L (nH)
2867002302	1	3.45 ±0.25 0.136	2.35 ±0.25 0.093	2.00 ±0.15 0.079	1.45 ±0.10 0.057	0.75 +0.25 0.034	0.10	18 Min
2867002702	1	7.00 ±0.25 0.276	3.10 ±0.25 0.122	4.20 -0.25 0.160	2.90 ±0.10 0.114	1.70 +0.20 0.071	0.30	24 Min
2867002402	1	7.00 ±0.25 0.276	6.20 ±0.25 0.244	4.20 -0.25 0.160	2.90 ±0.10 0.114	1.70 +0.20 0.071	0.50	48 Min
2867001502	1	13.30 ±0.60 0.525	6.60 ±0.25 0.260	7.50 ±0.35 0.295	5.70 ±0.25 0.225	3.80 ±0.25 0.150	1.70	44 Min
2867000302	1	13.30 ±0.60 0.525	10.30 ±0.30 0.407	7.50 ±0.35 0.295	5.70 ±0.25 0.225	3.80 ±0.25 0.150	2.60	68 Min
2867000102	1	13.30 ±0.60 0.525	13.40 ±0.30 0.528	7.50 ±0.35 0.295	5.70 ±0.25 0.225	3.80 ±0.25 0.150	3.50	89 Min
2867006802	1	13.30 ±0.60 0.525	27.00 ±0.75 1.062	7.50 ±0.35 0.295	5.70 ±0.25 0.225	3.80 ±0.25 0.150	7.00	180 Min

Quick Link: www.fair-rite.com/sbd

Surface mount beads are available from Fair-Rite in several materials and sizes. Their rugged construction lowers the dc resistance and increases current carrying capacity compared to plated beads.

- SM Beads on 12 mm tape width are supplied taped and reeled per EIA 481-1 and IEC 60286-3 standards. SM Beads on 16 and 24 mm tape widths are supplied taped and reeled per EIA 481-2 and IEC 60286-3 standards. Taped and reeled parts are supplied on a 13" reel.
- SM Beads can also be supplied not taped and reeled and then are bulk packed. This packing method will change the last digit of the part number to a "6".
- Wires are oxygen free high conductivity copper with 100% matte tin plating over a nickel undercoating.
- SM Beads meet the solderability specifications when tested in accordance with MIL-STD-202, method 208. After dipping the mounting site of the bead, the solder surface shall be at least 95% covered with a smooth solder coating. The edges of the copper strip are not specified as solderable surfaces.
- After preheating the beads to within 100 °C of the soldering temperature, the parts meet the resistance to soldering requirements of EIA-186-10E, temperature 260 ±5 °C and time 10 ±1 seconds.
- Suggested land patterns are in accordance with the latest revision of IPC-7351.
- SM Beads are controlled for impedance limits only. Minimum impedance values are specified for the + marked frequencies. The minimum impedance is typically the listed value less 20%. SM Beads in 73, 43 and 44 materials are measured for impedance on the 4193 Vector Impedance Analyzer. The 52 and 61 SM Beads are tested for impedance on the 4291A RF Impedance Analyzer.
- Recommended storage and operation temperature is -55 °C to 125 °C.
- The maximum practical current rating for these SM Beads is 5 amps, check the component bias curves. The 019/021/037 and 044 SM Beads can withstand a continuous current of 10 amps resulting in a component temperature rise < 40 °C
- Performance curves for these suppression components are on our web site.
- For any SM Bead requirement not listed, please contact our customer service group for availability and pricing.
- Our "Surface Mount Bead Kit" (part number 0199000025) is available for prototype evaluation.
- Explanation of Part Numbers: Digits 1&2 = product class, 3&4 = material grade, last digit 6 = bulk packed, 7 = taped and reeled.

SM Beads (Differential-Mode)



Quick Link: www.fair-rite.com/sbd

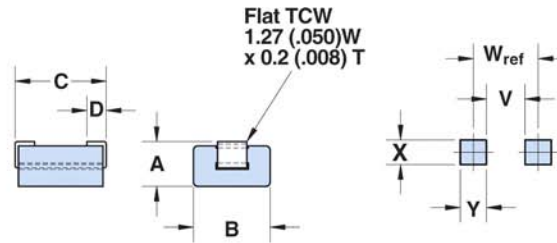

Figure 1

Land Pattern
for Fig. 1

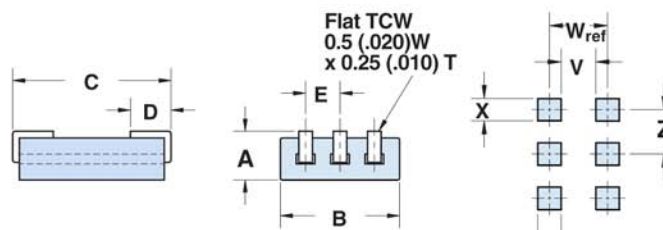

Figure 2

Land Pattern
for Fig. 2
E = Z

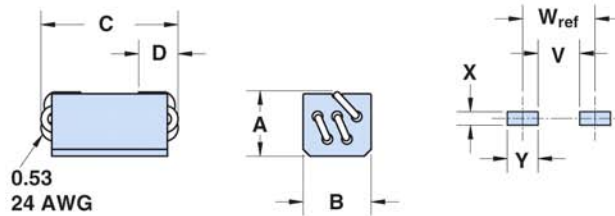

Figure 3

Land Pattern
for Fig. 3

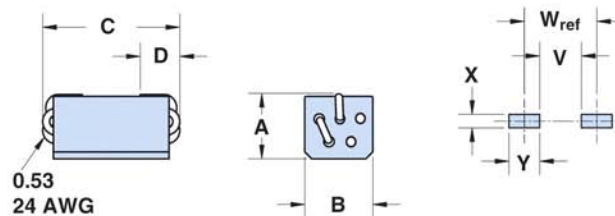

Figure 4

Land Pattern
for Fig. 4

SM Beads (Differential-Mode)



Quick Link: www.fair-rite.com/sbd

Legend

Dimensions (Top numbers are in millimeters, bottom numbers are in nominal inches.)

+ Test frequency

Lower Frequencies < 50 MHz (73 material)

Row #	Part Number	Fig.	A	B	C	D	Wt. (g)	Reel Information		
								Tape Width mm	Pitch mm	Parts 13" Reel
(1)	2773019447	1	2.85 ±0.20 0.112	3.05 ±0.10 0.120	5.10 -0.85 0.184	1.50 ±0.50 0.059	0.15	12	8	2800
(2)	2773019446	1	2.85 ±0.20 0.112	3.05 ±0.10 0.120	5.10 -0.85 0.184	1.50 ±0.50 0.059	0.15	-	-	-
(3)	2773021447	1	2.85 ±0.20 0.112	3.05 ±0.10 0.120	9.60 -0.95 0.359	1.50 ±0.50 0.059	0.30	16	8	2800
(4)	2773021446	1	2.85 ±0.20 0.112	3.05 ±0.10 0.120	9.60 -0.95 0.359	1.50 ±0.50 0.059	0.30	-	-	-
(5)	2773037447	1	2.70 ±0.20 0.106	4.60 ±0.20 0.181	9.25 -0.70 0.350	1.40 ±0.40 0.055	0.45	16	8	2800
(6)	2773037446	1	2.70 ±0.20 0.106	4.60 ±0.20 0.181	9.25 -0.70 0.350	1.40 ±0.40 0.055	0.45	-	-	-
(7)	2773044447	1	1.75 Max 0.068 Max	3.10 ±0.10 0.122	5.65 ±0.45 0.222	1.55 ±0.50 0.061	0.09	12	8	4500
(8)	2773044446	1	1.75 Max 0.068 Max	3.10 ±0.10 0.122	5.65 ±0.45 0.222	1.55 ±0.50 0.061	0.09	-	-	-

Table Continued ...

Row #	Part Number	Impedance (Ω)				Max Rdc (mΩ)	Land Patterns				
		1 MHz	5 MHz	10 MHz ⁺	25 MHz ⁺		V	W (ref)	X	Y	Z
(1)	2773019447	12	25	31	40	0.80	1.00 0.040	4.00 0.157	1.80 0.071	3.00 0.118	-
(2)	2773019446	12	25	31	40	0.80	1.00 0.040	4.00 0.157	1.80 0.071	3.00 0.118	-
(3)	2773021447	25	50	60	78	1.20	4.50 0.177	7.50 0.295	1.80 0.071	3.00 0.118	-
(4)	2773021446	25	50	60	78	1.20	4.50 0.177	7.50 0.295	1.80 0.071	3.00 0.118	-
(5)	2773037447	25	50	60	78	1.20	5.00 0.197	8.00 0.315	1.80 0.071	3.00 0.118	-
(6)	2773037446	25	50	60	78	1.20	5.00 0.197	8.00 0.315	1.80 0.071	3.00 0.118	-
(7)	2773044447	9	19	25	33	1.10	1.50 0.059	4.50 0.177	1.80 0.071	3.00 0.118	-
(8)	2773044446	9	19	25	33	1.10	1.50 0.059	4.50 0.177	1.80 0.071	3.00 0.118	-

Fair-Rite Products Corp. PO Box 288, One Commercial Row, Wallkill, NY 12589-0288

SM Beads (Differential-Mode)



Quick Link: www.fair-rite.com/sbd

Broadband Frequencies 25-300 MHz (43 & 44 materials)

Row #	Part Number	Fig.	A	B	C	D	E	Wt. (g)	Reel Information		
									Tape Width mm	Pitch mm	Parts 13" Reel
(9)	2743019447	1	2.85 ±0.20 0.112	3.05 ±0.10 0.120	5.10 -0.85 0.184	1.50 ±0.50 0.059	-	0.15	12	8	2800
(10)	2743019446	1	2.85 ±0.20 0.112	3.05 ±0.10 0.120	5.10 -0.85 0.184	1.50 ±0.50 0.059	-	0.15	-	-	-
(11)	2743021447	1	2.85 ±0.20 0.112	3.05 ±0.10 0.120	9.60 -0.95 0.359	1.50 ±0.50 0.059	-	0.30	16	8	2800
(12)	2743021446	1	2.85 ±0.20 0.112	3.05 ±0.10 0.120	9.60 -0.95 0.359	1.50 ±0.50 0.059	-	0.30	-	-	-
(13)	2743037447	1	2.70 ±0.20 0.106	4.60 ±0.20 0.181	9.25 -0.70 0.350	1.40 ±0.40 0.055	-	0.45	16	8	2800
(14)	2743037446	1	2.70 ±0.20 0.106	4.60 ±0.20 0.181	9.25 -0.70 0.350	1.40 ±0.40 0.055	-	0.45	-	-	-
(15)	2744044447	1	1.75 Max 0.068 Max	3.10 ±0.10 0.122	5.65 ±0.45 0.222	1.55 ±0.50 0.061	-	0.09	12	8	4500
(16)	2744044446	1	1.75 Max 0.068 Max	3.10 ±0.10 0.122	5.65 ±0.45 0.222	1.55 ±0.50 0.061	-	0.09	-	-	-
(17)	2744040447	2	1.95 Max 0.076 Max	4.50 ±0.20 0.177	6.40 -0.60 0.240	1.40 ±0.40 0.055	1.27 ±0.05 0.050	0.14	12	8	4000
(18)	2744040446	2	1.95 Max 0.076 Max	4.50 ±0.20 0.177	6.40 -0.60 0.240	1.40 ±0.40 0.055	1.27 ±0.05 0.050	0.14	-	-	-
(19)	2744555567	4	5.00 Max 0.197 Max	5.00 ±0.25 0.197	11.00 Max 0.433 Max	2.50 ±0.50 0.098	-	0.96	24	12	1500
(20)	2744555566	4	5.00 Max 0.197 Max	5.00 ±0.25 0.197	11.00 Max 0.433 Max	2.50 ±0.50 0.098	-	0.96	-	-	-
(21)	2744555577	3	5.00 Max 0.197 Max	5.00 ±0.25 0.197	11.00 Max 0.433 Max	2.50 ±0.50 0.098	-	0.96	24	12	1500
(22)	2744555576	3	5.00 Max 0.197 Max	5.00 ±0.25 0.197	11.00 Max 0.433 Max	2.50 ±0.50 0.098	-	0.96	-	-	-

Table Continued ...

Row #	Part Number	Impedance (Ω)				Max Rdc (mΩ)	Land Patterns				
		10 MHz	25 MHz ⁺	100 MHz ⁺	250 MHz		V	W (ref)	X	Y	Z
(9)	2743019447	18	29	47	49	0.80	1.00 0.040	4.00 0.157	1.80 0.071	3.00 0.118	-
(10)	2743019446	18	29	47	49	0.80	1.00 0.040	4.00 0.157	1.80 0.071	3.00 0.118	-
(11)	2743021447	37	56	95	100	1.20	4.50 0.177	7.50 0.295	1.80 0.071	3.00 0.118	-
(12)	2743021446	37	56	95	100	1.20	4.50 0.177	7.50 0.295	1.80 0.071	3.00 0.118	-
(13)	2743037447	37	56	95	100	1.20	5.00 0.197	8.00 0.315	1.80 0.071	3.00 0.118	-
(14)	2743037446	37	56	95	100	1.20	5.00 0.197	8.00 0.315	1.80 0.071	3.00 0.118	-
(15)	2744044447	13	21	36	39	1.10	1.50 0.059	4.50 0.177	1.80 0.071	3.00 0.118	-
(16)	2744044446	13	21	36	39	1.10	1.50 0.059	4.50 0.177	1.80 0.071	3.00 0.118	-
(17)	2744040447	18	29	56	60	1.60	1.80 0.071	4.80 0.189	0.80 0.032	3.00 0.118	1.27 0.050
(18)	2744040446	18	29	56	60	1.60	1.80 0.071	4.80 0.189	0.80 0.032	3.00 0.118	1.27 0.050
(19)	2744555567	150	250	375	385	3.80	2.00 0.079	7.00 0.276	2.00 0.079	5.00 0.197	-

Fair-Rite Products Corp. PO Box 288, One Commercial Row, Wallkill, NY 12589-0288

Phone: (888) FAIR RITE / (845) 895-2055 • Fax: (888) FERRITE / (845) 895-2629 • Web: www.fair-rite.com
 (888) 324-7748 (888) 337-7483 E -mail: ferrites@fair-rite.com

SM Beads (Differential-Mode)



Quick Link: www.fair-rite.com/sbd

Table Continued ...

Row #	Part Number	Impedance (Ω)				Max Rdc (m Ω)	Land Patterns				
		10 MHz	25 MHz ⁺	100 MHz ⁺	250 MHz		V	W (ref)	X	Y	Z
(20)	2744555566	150	250	375	385	3.80	2.00 0.079	7.00 0.276	2.00 0.079	5.00 0.197	-
(21)	2744555577	255	425	600	575	6.20	2.00 0.079	7.00 0.276	2.00 0.079	5.00 0.197	-
(22)	2744555576	255	425	600	575	6.20	2.00 0.079	7.00 0.276	2.00 0.079	5.00 0.197	-

Higher Frequencies 250-1000 MHz (52 & 61 materials)

Row #	Part Number	Fig.	A	B	C	D	Wt. (g)	Reel Information		
								Tape Width mm	Pitch mm	Parts 13" Reel
(23)	2761019447	1	2.85 \pm 0.20 0.112	3.05 \pm 0.10 0.120	5.10 -0.85 0.184	1.50 \pm 0.50 0.059	0.15	12	8	2800
(24)	2761019446	1	2.85 \pm 0.20 0.112	3.05 \pm 0.10 0.120	5.10 -0.85 0.184	1.50 \pm 0.50 0.059	0.15	-	-	-
(25)	2761021447	1	2.85 \pm 0.20 0.112	3.05 \pm 0.10 0.120	9.60 -0.95 0.359	1.50 \pm 0.50 0.059	0.30	16	8	2800
(26)	2761021446	1	2.85 \pm 0.20 0.112	3.05 \pm 0.10 0.120	9.60 -0.95 0.359	1.50 \pm 0.50 0.059	0.30	-	-	-
(27)	2752555567	4	5.00 Max 0.197 Max	5.00 \pm 0.25 0.197	11.00 Max 0.433 Max	2.50 \pm 0.50 0.098	0.96	24	12	1500
(28)	2752555566	4	5.00 Max 0.197 Max	5.00 \pm 0.25 0.197	11.00 Max 0.433 Max	2.50 \pm 0.50 0.098	0.96	-	-	-
(29)	2752555577	3	5.00 Max 0.197 Max	5.00 \pm 0.25 0.197	11.00 Max 0.433 Max	2.50 \pm 0.50 0.098	0.96	24	12	1500
(30)	2752555576	3	5.00 Max 0.197 Max	5.00 \pm 0.25 0.197	11.00 Max 0.433 Max	2.50 \pm 0.50 0.098	0.96	-	-	-

Table Continued ...

Row #	Part Number	Impedance (Ω)				Max Rdc (m Ω)	Land Patterns				
		100 MHz	250 MHz ⁺	500 MHz ⁺	1000 MHz		V	W (ref)	X	Y	Z
(23)	2761019447	36	50	55	59	0.80	1.00 0.040	4.00 0.157	1.80 0.071	3.00 0.118	-
(24)	2761019446	36	50	55	59	0.80	1.00 0.040	4.00 0.157	1.80 0.071	3.00 0.118	-
(25)	2761021447	69	94	106	118	1.20	4.50 0.177	7.50 0.295	1.80 0.071	3.00 0.118	-
(26)	2761021446	69	94	106	118	1.20	4.50 0.177	7.50 0.295	1.80 0.071	3.00 0.118	-
(27)	2752555567	400	490	425	250	3.80	2.00 0.079	7.00 0.276	2.00 0.079	5.00 0.197	-
(28)	2752555566	400	490	425	250	3.80	2.00 0.079	7.00 0.276	2.00 0.079	5.00 0.197	-
(29)	2752555577	700	770	440	250	6.20	2.00 0.079	7.00 0.276	2.00 0.079	5.00 0.197	-
(30)	2752555576	700	770	440	250	6.20	2.00 0.079	7.00 0.276	2.00 0.079	5.00 0.197	-

Fair-Rite Products Corp. PO Box 288, One Commercial Row, Wallkill, NY 12589-0288

SM Beads (Common-Mode)



Quick Link: www.fair-rite.com/sbc

Surface mount common-mode beads are available from Fair-Rite in several materials and sizes. The common-mode bead provides a common magnetic path for the flux generated by the current to the load and the return current from the load. The current compensation results in zero magnetic flux in the bead.

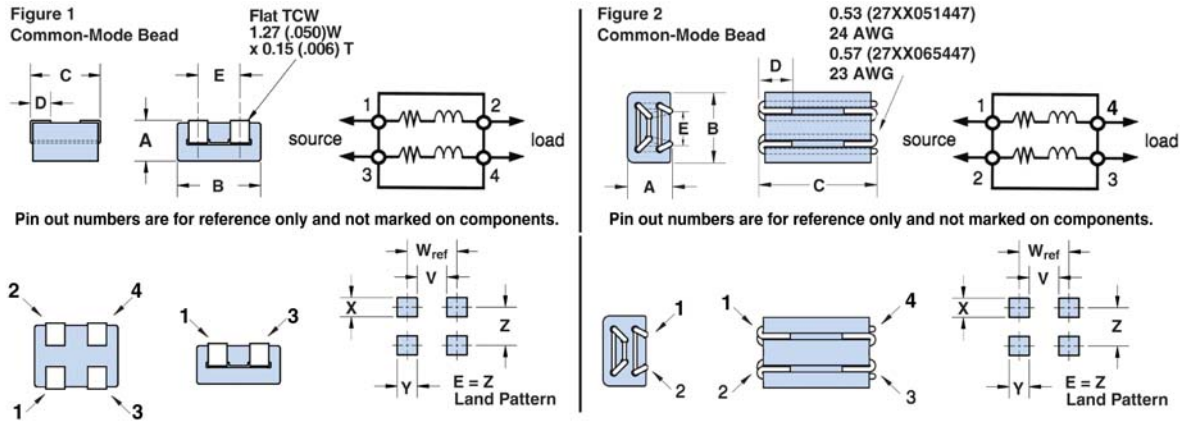

- SM Beads on 12 mm tape width are supplied taped and reeled per EIA 481-1 and IEC 60286-3 standards. SM Beads on 16 and 24 mm tape widths are supplied taped and reeled per EIA 481-2 and IEC 60286-3 standards. Taped and reeled parts are supplied on a 13" reel.
- SM Beads can also be supplied not taped and reeled and then are bulk packed. This packing method will change the last digit of the part number to a "6".
- Wires are oxygen free high conductivity copper with 100% matte tin plating over a nickel undercoating.
- SM Beads meet the solderability specifications when tested in accordance with MIL-STD-202, method 208. After dipping the mounting site of the bead, the solder surface shall be at least 95% covered with a smooth solder coating. The edges of the copper strip are not specified as solderable surfaces.
- After preheating the beads to within 100 °C of the soldering temperature, the parts meet the resistance to soldering requirements of EIA-186-10E, temperature 260±5 °C and time 10±1 seconds.
- Suggested land patterns are in accordance with the latest revision of IPC-7351.
- SM Beads are controlled for impedance limits only. Minimum impedance values are specified for the + marked frequencies. The minimum impedance is typically the listed value less 20%. SM Beads in 44 materials are measured for impedance on the 4193 Vector Impedance Analyzer. The 52 SM Beads are tested for impedance on the 4291A RF Impedance Analyzer.
- Recommended storage and operation temperature is -55 °C to 125 °C.
- The maximum current rating for these SM Beads is 5 amps.
- Performance curves for these suppression components are our web site.
- For any SM Bead requirement not listed, please contact our customer service group for availability and pricing.
- Our "Surface Mount Bead Kit" (part number 0199000025) is available for prototype evaluation.
- Explanation of Part Numbers: Digits 1&2 = product class, 3&4 = material grade, last digit 6 = bulk packed, 7 = taped and reeled.

Fair-Rite Products Corp. PO Box 288, One Commercial Row, Wallkill, NY 12589-0288

Phone: (888) FAIR RITE / (845) 895-2055 • Fax: (888) FERRITE / (845) 895-2629 • Web: www.fair-rite.com
(888) 324-7748 (888) 337-7483 E -mail: ferrites@fair-rite.com

SM Beads (Common-Mode)



Quick Link: www.fair-rite.com/sbc

Legend

Dimensions (Top numbers are in millimeters, bottom numbers are in nominal inches.)

* Test frequency

Broadband Frequencies 10-300 MHz (44 material)

Row #	Part Number	Fig.	A	B	C	D	E	Wt. (g)	Reel Information		
									Tape Width mm	Pitch mm	Parts 13" Reel
(1)	2744041447	1	2.85 ±0.20 0.112	5.60 ±0.20 0.220	5.00 -0.60 0.185	1.35 ±0.50 0.053	2.54 ±0.25 0.100	0.30	12	8	2400
(2)	2744041446	1	2.85 ±0.20 0.112	5.60 ±0.20 0.220	5.00 -0.60 0.185	1.35 ±0.50 0.053	2.54 ±0.25 0.100	0.30	-	-	-
(3)	2744045447	1	2.85 ±0.20 0.112	5.60 ±0.20 0.220	8.90 -0.80 0.335	1.35 ±0.50 0.053	2.54 ±0.25 0.100	0.53	16	8	2400
(4)	2744045446	1	2.85 ±0.20 0.112	5.60 ±0.20 0.220	8.90 -0.80 0.335	1.35 ±0.50 0.053	2.54 ±0.25 0.100	0.53	-	-	-
(5)	2744051447	2	4.50 Max 0.177 Max	6.65 Max 0.262 Max	12.00 Max 0.472 Max	2.50 ±0.50 0.098	3.00 ±0.10 0.118	1.00	24	12	1000
(6)	2744051446	2	4.50 Max 0.177 Max	6.65 Max 0.262 Max	12.00 Max 0.472 Max	2.50 ±0.50 0.098	3.00 ±0.10 0.118	1.00	-	-	-
(7)	2744065447	2	5.30 Max 0.209 Max	7.00 Max 0.275 Max	14.80 Max 0.582 Max	2.50 ±0.50 0.098	3.00 ±0.10 0.118	1.80	24	12	1000
(8)	2744065446	2	5.30 Max 0.209 Max	7.00 Max 0.275 Max	14.80 Max 0.582 Max	2.50 ±0.50 0.098	3.00 ±0.10 0.118	1.80	-	-	-

Table Continued ...

Row #	Part Number	Impedance (Ω)					Max Rdc (mΩ)	Land Patterns				
		10 MHz	25 MHz ⁺	100 MHz ⁺	250 MHz	300 MHz		V	W (ref)	X	Y	Z
(1)	2744041447	12	20	33	41	-	1.10	1.00 0.040	4.00 0.158	1.80 0.071	3.00 0.118	2.54 0.100
(2)	2744041446	12	20	33	41	-	1.10	1.00 0.040	4.00 0.158	1.80 0.071	3.00 0.118	2.54 0.100
(3)	2744045447	23	38	60	78	-	1.40	4.00 0.158	7.00 0.276	1.80 0.071	3.00 0.118	2.54 0.100
(4)	2744045446	23	38	60	78	-	1.40	4.00 0.158	7.00 0.276	1.80 0.071	3.00 0.118	2.54 0.100
(5)	2744051447	60	100	230	-	275	4.00	4.00 0.158	9.00 0.354	1.00 0.040	5.00 0.197	3.00 0.118
(6)	2744051446	60	100	230	-	275	4.00	4.00 0.158	9.00 0.354	1.00 0.040	5.00 0.197	3.00 0.118
(7)	2744065447	95	145	255	-	315	4.10	6.80 0.268	11.80 0.465	1.10 0.043	5.00 0.197	3.00 0.118
(8)	2744065446	95	145	255	-	315	4.10	6.80 0.268	11.80 0.465	1.10 0.043	5.00 0.197	3.00 0.118

Fair-Rite Products Corp. PO Box 288, One Commercial Row, Wallkill, NY 12589-0288

SM Beads (Common-Mode)



Quick Link: www.fair-rite.com/sbc

Higher Frequencies 250-1000 MHz (52 material)

Row #	Part Number	Fig.	A	B	C	D	E	Wt. (g)	Reel Information		
									Tape Width mm	Pitch mm	Parts 13" Reel
(9)	2752041447	1	2.85 ±0.20 0.112	5.60 ±0.20 0.220	5.00 -0.60 0.185	1.35 ±0.50 0.053	2.54 ±0.25 0.100	0.30	12	8	2400
(10)	2752041446	1	2.85 ±0.20 0.112	5.60 ±0.20 0.220	5.00 -0.60 0.185	1.35 ±0.50 0.053	2.54 ±0.25 0.100	0.30	-	-	-
(11)	2752045447	1	2.85 ±0.20 0.112	5.60 ±0.20 0.220	8.90 -0.80 0.335	1.35 ±0.50 0.053	2.54 ±0.25 0.100	0.53	16	8	2400
(12)	2752045446	1	2.85 ±0.20 0.112	5.60 ±0.20 0.220	8.90 -0.80 0.335	1.35 ±0.50 0.053	2.54 ±0.25 0.100	0.53	-	-	-
(13)	2752051447	2	4.50 Max 0.177 Max	6.65 Max 0.262 Max	12.00 Max 0.472 Max	2.50 ±0.50 0.098	3.00 ±0.10 0.118	1.00	24	12	1000
(14)	2752051446	2	4.50 Max 0.177 Max	6.65 Max 0.262 Max	12.00 Max 0.472 Max	2.50 ±0.50 0.098	3.00 ±0.10 0.118	1.00	-	-	-
(15)	2752065447	2	5.30 Max 0.209 Max	7.00 Max 0.275 Max	14.80 Max 0.582 Max	2.50 ±0.50 0.098	3.00 ±0.10 0.118	1.80	24	12	1000
(16)	2752065446	2	5.30 Max 0.209 Max	7.00 Max 0.275 Max	14.80 Max 0.582 Max	2.50 ±0.50 0.098	3.00 ±0.10 0.118	1.80	-	-	-

Table Continued ...

Row #	Part Number	Impedance (Ω)				Max Rdc (mΩ)	Land Patterns				
		100 MHz	250 MHz ⁺	500 MHz ⁺	1000 MHz		V	W (ref)	X	Y	Z
(9)	2752041447	30	50	60	70	1.10	1.00 0.040	4.00 0.158	1.80 0.071	3.00 0.118	2.54 0.100
(10)	2752041446	30	50	60	70	1.10	1.00 0.040	4.00 0.158	1.80 0.071	3.00 0.118	2.54 0.100
(11)	2752045447	58	90	115	130	1.40	4.00 0.158	7.00 0.276	1.80 0.071	3.00 0.118	2.54 0.100
(12)	2752045446	58	90	115	130	1.40	4.00 0.158	7.00 0.276	1.80 0.071	3.00 0.118	2.54 0.100
(13)	2752051447	200	330	340	350	4.00	4.00 0.158	9.00 0.354	1.00 0.040	5.00 0.197	3.00 0.118
(14)	2752051446	200	330	340	350	4.00	4.00 0.158	9.00 0.354	1.00 0.040	5.00 0.197	3.00 0.118
(15)	2752065447	230	380	450	380	4.10	6.80 0.268	11.80 0.465	1.10 0.043	5.00 0.197	3.00 0.118
(16)	2752065446	230	380	450	380	4.10	6.80 0.268	11.80 0.465	1.10 0.043	5.00 0.197	3.00 0.118

Fair-Rite Products Corp. PO Box 288, One Commercial Row, Wallkill, NY 12589-0288

Phone: (888) FAIR RITE / (845) 895-2055 • Fax: (888) FERRITE / (845) 895-2629 • Web: www.fair-rite.com
 (888) 324-7748 (888) 337-7483 E -mail: ferrites@fair-rite.com

Quick Link: www.fair-rite.com/cb

Fair-Rite offers a broad selection of cost effective multi-layer chip beads to suppress conducted EMI signals. Chip beads can be used in an array of devices such as cellular phones, computers, laptops, pagers, etc. The small package sizes accommodate automated placements and allow for a dense packaging of circuit boards. Chip beads are 100% tested for impedance and dc resistance. They are available in standard, high and GHz signal speeds. The multi-layer chip beads are organized by increasing package size and current carrying capacity.

- All multi-layer chip beads are supplied taped and reeled, if required bulk packed chip beads can be provided.
- The impedance values listed are typical values. The nominal impedance with a +/- 25% tolerance is specified for the + marked 100 MHz. Chip beads are measured for impedance on the HP 4291A and fixture HP 16192A.
- Chip beads have plated contacts, 100% matte tin over a nickel undercoating. They can accommodate both reflow and wave soldering technologies.
- The suggested land patterns are in accordance to the latest revision of IPC-7351.
- Recommended storage and operating temperature range is -55 °C to 125 °C.
- Performance curves for these suppression components are our web site.
- Our "Chip Bead Kit" (part number 0199000018) is available for prototype evaluation.

Part Number System: Example 2512063017Y1

25	1206	301	7	Y	1
Chip Bead Code	Package Size Code	Impedance Code	Packaging Code	Material Code	Current Code
		300Ω	6= Bulk Packed 7= Taped and Reeled 7" Reel 8= Taped and Reeled 13" Reel	Y = Standard Signal Speed Z = High Signal Speed H = GHz Speed	0 < 1.0A 1 ≥ 1.0A < 2.0A 3 ≥ 3.0A < 4.0A ETC

Chip Beads



Quick Link: www.fair-rite.com/cb

Legend

Dimensions (Top numbers are in millimeters, bottom numbers are in nominal inches.)

Pkg. Size	A	B	C	D	Wt. (g)	Land Patterns				Reel Information			
						V	W (ref)	X	Y	Tape Width mm	Pitch mm	Parts 7" Reel	Parts 13" Reel
0402 (1005)	0.5±0.05 0.020	0.5±0.05 0.020	1.0±0.05 0.040	0.25±0.15 0.010	0.002	0.40 0.016	1.30 0.051	0.70 0.028	0.90 0.035	8	4	10000	—
0603 (1608)	0.8±0.15 0.031	0.8±0.15 0.031	1.6±0.15 0.063	0.4±0.2 0.016	0.006	0.60 0.024	1.70 0.067	1.00 0.039	1.10 0.043	8	4	4000	10000
0805 (2012)	0.9±0.2 0.035	1.25±0.2 0.049	2.0±0.2 0.079	0.5±0.3 0.020	0.01	0.60 0.024	1.90 0.075	1.50 0.059	1.30 0.051	8	4	4000	10000
1206 (3216)	1.1±0.2 0.043	1.6±0.2 0.063	3.2±0.2 0.126	0.7±0.3 0.028	0.03	1.20 0.047	2.80 0.110	1.80 0.071	1.60 0.063	8	4	3000	10000
1806 (4516)	1.6±0.2 0.063	1.6±0.2 0.063	4.5±0.2 0.177	0.7±0.3 0.028	0.06	2.00 0.079	3.90 0.154	1.80 0.071	1.90 0.075	12	8	2000	10000
1812 (4532)	1.5±0.2 0.059	3.2±0.2 0.126	4.5±0.2 0.177	0.7±0.3 0.028	0.09	2.00 0.079	3.90 0.154	3.40 0.134	1.90 0.075	12	8	1000	5000

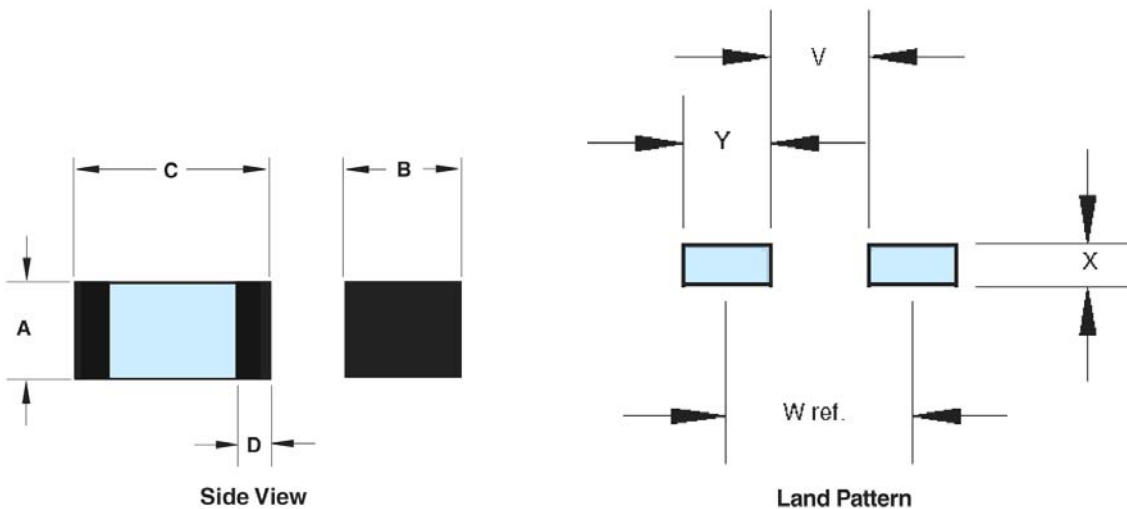

Fair-Rite Products Corp. PO Box 288, One Commercial Row, Wallkill, NY 12589-0288

Phone: (888) FAIR RITE / (845) 895-2055 • Fax: (888) FERRITE / (845) 895-2629 • Web: www.fair-rite.com
 (888) 324-7748 (888) 337-7483 E -mail: ferrites@fair-rite.com

Legend

Chip Beads are listed in ascending order by current, package size, impedance and signal speed. * Test frequency

Low Current

Part Number	Pkg. Size	Impedance (Ω)					Signal Speed	Max DCR (Ω)	Max Current (mA)
		50 MHz	100 MHz ⁺	500 MHz	1000 MHz	1000 MHz ⁺			
2504021007Y0	0402 (1005)	8	10 \pm 25%	13	14	-	Standard	0.050	500
2504026007Y0	0402 (1005)	48	60 \pm 25%	79	79	-	Standard	0.400	200
2504021217Y0	0402 (1005)	88	120 \pm 25%	170	157	-	Standard	0.500	200
2504023017Y0	0402 (1005)	234	300 \pm 25%	370	264	-	Standard	0.750	100
2504026017Y0	0402 (1005)	421	600 \pm 25%	652	362	-	Standard	1.100	50
2506033007Y0	0603 (1608)	23	30 \pm 25%	46	48	-	Standard	0.100	400
2506036007Y0	0603 (1608)	45	60 \pm 25%	94	82	-	Standard	0.150	400
2506038007Y0	0603 (1608)	59	80 \pm 25%	121	102	-	Standard	0.150	400
2506031017Y0	0603 (1608)	77	100 \pm 25%	144	131	-	Standard	0.150	400
2506031217Y0	0603 (1608)	90	120 \pm 25%	179	142	-	Standard	0.150	400
2506031517Y0	0603 (1608)	109	150 \pm 25%	224	179	-	Standard	0.150	400
2506033017Y0	0603 (1608)	213	300 \pm 25%	326	205	-	Standard	0.300	400
2506036017Y0	0603 (1608)	426	600 \pm 25%	405	226	-	Standard	0.350	400
2506031027Y0	0603 (1608)	653	1000 \pm 25%	241	110	-	Standard	0.550	300
2506036007Z0	0603 (1608)	28	60 \pm 25%	145	96	-	High	0.250	450
2506031217Z0	0603 (1608)	60	120 \pm 25%	278	192	-	High	0.300	450
2506033017Z0	0603 (1608)	112	300 \pm 25%	314	142	-	High	0.350	450
2506030707H0	0603 (1608)	4	7 \pm 25%	30	38	-	GHz	0.100	900
2506031007H0	0603 (1608)	5	10 \pm 25%	43	50	-	GHz	0.100	900
2506031217H0	0603 (1608)	50	120 \pm 25%	600	-	500 \pm 40%	GHz	0.500	200
2506032217H0	0603 (1608)	100	220 \pm 25%	800	-	1100 \pm 40%	GHz	0.800	100
2506033317H0	0603 (1608)	150	330 \pm 25%	1300	-	1300 \pm 40%	GHz	1.200	50
2506031027H0	0603 (1608)	500	1000 \pm 25%	1800	-	1200	GHz	1.500	50
2508051107Y0	0805 (2012)	8	11 \pm 25%	16	16	-	Standard	0.100	300
2508053007Y0	0805 (2012)	22	30 \pm 25%	46	49	-	Standard	0.100	300
2508055007Y0	0805 (2012)	36	50 \pm 25%	73	76	-	Standard	0.150	300

Quick Link: www.fair-rite.com/cb

Low Current

Part Number	Pkg. Size	Impedance (Ω)					Signal Speed	Max DCR (Ω)	Max Current (mA)
		50 MHz	100 MHz ⁺	500 MHz	1000 MHz	1000 MHz ⁺			
2508056007Y0	0805 (2012)	45	60 \pm 25%	88	89	-	Standard	0.150	300
2508059007Y0	0805 (2012)	68	90 \pm 25%	125	107	-	Standard	0.150	300
2508051017Y0	0805 (2012)	75	100 \pm 25%	134	120	-	Standard	0.200	300
2508051217Y0	0805 (2012)	89	120 \pm 25%	172	127	-	Standard	0.200	300
2508051817Y0	0805 (2012)	134	180 \pm 25%	198	111	-	Standard	0.200	300
2508053017Y0	0805 (2012)	216	300 \pm 25%	161	84	-	Standard	0.250	300
2508056017Y0	0805 (2012)	428	600 \pm 25%	284	141	-	Standard	0.350	300
2508051027Y0	0805 (2012)	688	1000 \pm 25%	300	148	-	Standard	0.450	300
2508051527Y0	0805 (2012)	989	1500 \pm 25%	235	118	-	Standard	0.700	300
2508056007Z0	0805 (2012)	28	60 \pm 25%	111	122	-	High	0.150	300
2508051217Z0	0805 (2012)	45	120 \pm 25%	253	191	-	High	0.200	300
2508053017Z0	0805 (2012)	118	300 \pm 25%	280	139	-	High	0.250	200
2508052027Z0	0805 (2012)	440	2000 \pm 25%	160	80	-	High	0.400	200
2512063007Y0	1206 (3216)	21	30 \pm 25%	49	52	-	Standard	0.100	800
2512065007Y0	1206 (3216)	38	50 \pm 25%	68	67	-	Standard	0.150	800
2512067007Y0	1206 (3216)	53	70 \pm 25%	101	102	-	Standard	0.150	500
2512069007Y0	1206 (3216)	72	90 \pm 25%	121	113	-	Standard	0.150	450
2512061017Y0	1206 (3216)	72	100 \pm 25%	127	86	-	Standard	0.200	450
2512061217Y0	1206 (3216)	87	120 \pm 25%	151	109	-	Standard	0.200	450
2512063017Y0	1206 (3216)	203	300 \pm 25%	233	118	-	Standard	0.200	350
2512066017Y0	1206 (3216)	581	600 \pm 25%	116	67	-	Standard	0.250	350
2512061027Y0	1206 (3216)	784	1000 \pm 25%	230	117	-	Standard	0.350	350
2512061527Y0	1206 (3216)	1600	1500 \pm 25%	120	25	-	Standard	0.400	350
2518061017Y0	1806 (4516)	73	100 \pm 25%	153	155	-	Standard	0.300	400
2518061517Y0	1806 (4516)	110	150 \pm 25%	205	167	-	Standard	0.500	200

Quick Link: www.fair-rite.com/cb

Medium Current

Part Number	Pkg. Size	Impedance (Ω)				Signal Speed	Max DCR (Ω)	Max Current (mA)
		50 MHz	100 MHz [†]	500 MHz	1000 MHz			
2506033007Y3	0603 (1608)	23	30 \pm 25%	40	41	Standard	0.040	3000
2506036007Y3	0603 (1608)	48	60 \pm 25%	84	81	Standard	0.040	3000
2506031217Y2	0603 (1608)	90	120 \pm 25%	170	152	Standard	0.050	2000
2508053007Y3	0805 (2012)	23	30 \pm 25%	41	41	Standard	0.030	3000
2508056007Y3	0805 (2012)	49	60 \pm 25%	84	84	Standard	0.040	3000
2508051217Y3	0805 (2012)	91	120 \pm 25%	165	135	Standard	0.050	3000
2508053017Y3	0805 (2012)	239	300 \pm 25%	218	117	Standard	0.050	3000
2508056017Y2	0805 (2012)	449	600 \pm 25%	293	159	Standard	0.100	2000
2508051027Y1	0805 (2012)	764	1000 \pm 25%	402	216	Standard	0.300	1000
2508052027Y1	0805 (2012)	599	2000 \pm 25%	350	189	Standard	0.300	1000
2512063007Y3	1206 (3216)	24	30 \pm 25%	40	38	Standard	0.030	3000
2512065007Y3	1206 (3216)	39	50 \pm 25%	69	70	Standard	0.030	3000
2512067007Y3	1206 (3216)	53	70 \pm 25%	102	103	Standard	0.040	3000
2512061517Y3	1206 (3216)	120	150 \pm 25%	173	130	Standard	0.050	3000
2512063017Y3	1206 (3216)	212	300 \pm 25%	150	88	Standard	0.060	3000
2512066017Y1	1206 (3216)	460	600 \pm 25%	260	120	Standard	0.150	1000
2512061027Y1	1206 (3216)	925	1000 \pm 25%	210	117	Standard	0.300	1000
2518066007Y3	1806 (4516)	44	60 \pm 25%	91	94	Standard	0.040	3000
2518068007Y3	1806 (4516)	64	80 \pm 25%	114	114	Standard	0.040	3000
2518127007Y3	1812 (4532)	54	70 \pm 25%	96	96	Standard	0.040	3000
2518121217Y3	1812 (4532)	92	120 \pm 25%	150	106	Standard	0.040	3000

Quick Link: www.fair-rite.com/cb

High Current

Part Number	Pkg. Size	Impedance (Ω)				Signal Speed	Max DCR (Ω)	Max Current (mA)
		50 MHz	100 MHz ⁺	500 MHz	1000 MHz			
2508056007Y6	0805 (2012)	47	60 \pm 25%	88	68	Standard	0.020	6000
2508051217Y6	0805 (2012)	94	120 \pm 25%	158	132	Standard	0.025	6000
2512065007Y6	1206 (3216)	39	50 \pm 25%	68	56	Standard	0.008	6000
2512061217Y5	1206 (3216)	96	120 \pm 25%	137	91	Standard	0.025	5000
2518065007Y6	1806 (4516)	36	50 \pm 25%	63	61	Standard	0.010	6000
2518061017Y6	1806 (4516)	75	100 \pm 25%	139	132	Standard	0.020	6000
2518121217Y6	1812 (4532)	92	120 \pm 25%	149	105	Standard	0.020	6000

Quick Link: www.fair-rite.com/ca

Fair-Rite offers an effective cost and real estate reduction by our line of chip arrays. Four chip beads, packaged in a 1206 (3216) size, for suppression of conducted EMI where size is at a premium. Chip arrays are 100% tested for impedance and dc resistance.

- Chip arrays have plated contacts, 100% matte tin over a nickel undercoating.
- Chip arrays are supplied taped and reeled.
- Chip arrays are controlled for impedance. The impedance values listed are typical values. The nominal impedance with a +/- 25% tolerance is specified for the + marked 100 MHz frequency. Chip arrays are measured for impedance on the HP 4291A and fixture HP 16192A.
- The arrays can accommodate both reflow and wave soldering technologies.
- Suggested land patterns are in accordance to the IPC-7351.
- Recommended storage and operating temperature range is -55 °C to 125 °C.
- Performance curves for these suppression components are on our web site.
- “Chip Bead Kit” (part number 0199000018) contains the 600 ohm 4 line chip array.
- The maximum voltage between adjacent beads is 5V.

Part Number System: Example 2512066007Y0A4

25	1206	600	7	Y	0	A4
Chip Suppression Component	Package Size	Impedance Code	Packaging Code	Material Code	Current Code	Array 4 Lines
		600 = 60 Ω	6= Bulk Packed 7= Taped and Reeled 7" Reel 8= Taped and Reeled 13" Reel	Y = Std Signal Speed	0 < 1A	

Quick Link: www.fair-rite.com/ca

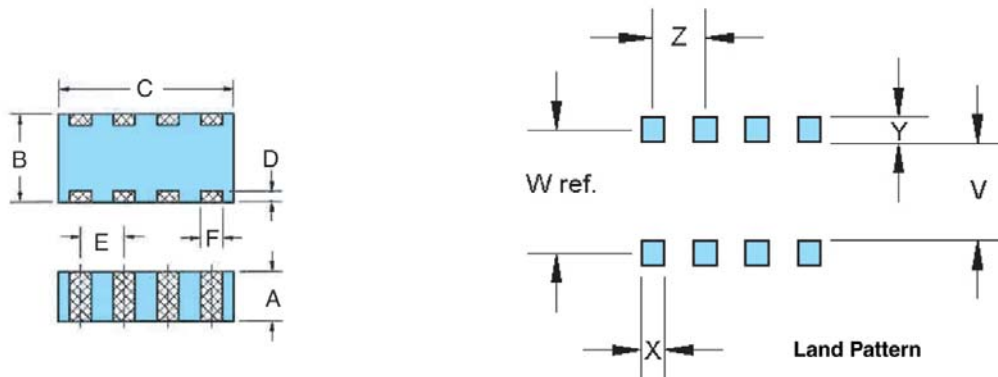

Legend

Dimensions (Top numbers are in millimeters, bottom numbers are in nominal inches.)

* Test frequency

Pkg. Size	A	B	C	D	E	F	Wt. (g)	Land Patterns					Reel Information		
								V	W (ref)	X	Y	Z	Tape Width mm	Pitch mm	Parts 7" Reel
1206 (3216)	0.8±0.2 0.032	1.6±0.2 0.063	3.2±0.2 0.126	0.3±0.2 0.011	0.8±0.1 0.032	0.45±0.2 0.018	0.03	0.7 0.028	1.3 0.051	0.5 0.020	0.6 0.024	0.8 0.032	8	4	3000

Standard Signal Speed

Part Number	Pkg. Size	Impedance (Ω)				Max DCR (Ω)	Max Current (mA)
		50 MHz	100 MHz ⁺	500 MHz	1000 MHz		
2512066007Y0A4	1206 (3216)	48	60 ±25%	77	75	0.250	200
2512061217Y0A4	1206 (3216)	95	120 ±25%	150	118	0.300	150
2512063017Y0A4	1206 (3216)	225	300 ±25%	280	160	0.300	150
2512066017Y0A4	1206 (3216)	460	600 ±25%	400	205	0.500	100
2512061027Y0A4	1206 (3216)	770	1000 ±25%	400	200	0.700	50

Engineering Kits



Quick Link: www.fair-rite.com/kit



Fair-Rite Products Corp. PO Box 288, One Commercial Row, Wallkill, NY 12589-0288

Quick Link: www.fair-rite.com/kit

Expanded Cable & Suppressor Kit

Part Number	Kit Description
0199000005	Contains a broad sampling of suppression cores to reduce conducted EMI over wires and cables.

Round Cable Cores 31 Matl (1-300 MHz)	Qty
2631102002	2
2631540002	2
2631665702	2
Round Cable Cores 43 Matl (25-300 MHz)	Qty
2643626502	2
2643801002	2
2643802702	2
Round Cable Cores 46 Matl (25-300 MHz)	Qty
2646102002	2
2646540002	2
2646625002	2
2646625102	2
2646665702	2
2646665802	2
2646803802	2
2646804502	2

Round Cable Cores 61 Matl (200-1000 MHz)	Qty
2661102002	2
2661540002	2
2661665702	2
Clips	Qty
0199001401	8
Flat Cable Cores 31 Matl (1-300 MHz)	Qty
2631163851	2
Flat Cable Cores 43 Matl (25-300 MHz)	Qty
2643163851	2
2643163951	2
2643164051	2
2643166651	2
2643166851	4

Round Cable Snap-Its 43 Matl (25-300 MHz)	Qty
0443178181	2
Round Cable Snap-Its 46 Matl (25-300 MHz)	Qty
0446164151	2
0446164251	2
0446167251	2
Round Cable Snap-Its 61 Matl (200-1000 MHz)	Qty
0461164281	2
0461167281	2
Flat Cable Snap-Its 43 Matl (25-300 MHz)	Qty
0443163951	1
0443164051	1
0443166651	1

Chip Bead Kit

Part Number	Kit Description
0199000018	Contains a number of different EIA size chip components with a range of impedance values and signal speeds. Also included is one of our chip arrays.

Chip Bead 0402 (1005)	Z (Ω) 100 MHz	Qty
2504026017Y0	600	80
Chip Beads 0603 (1608)	Z (Ω) 100 MHz	Qty
2506031017Y0	100	75
2506031217Y0	120	75
2506033017Y0	300	75
2506036017Y0	600	75
2506031007H0	10	75
2506031217Y2	120	75

Chip Beads 0805 (2012)	Z (Ω) 100 MHz	Qty
2508051217Y0	120	60
2508053017Z0	300	60
2508053017Y3	300	60
2508056017Y2	600	60
2508052027Y1	2000	60
2508056007Y6	60	60

Chip Beads 1206 (3216)	Z (Ω) 100 MHz	Qty
2512069007Y0	90	50
2512066017Y0	600	50
2512061517Y3	150	50
2512061027Y1	1000	50
2512061217Y5	120	50
Chip Bead 1806 (4516)	Z (Ω) 100 MHz	Qty
2518065007Y6	50	40
Chip Array 1206 (3216)	Z (Ω) 100 MHz	Qty
2512066017Y0A4	600 (4)	40

Quick Link: www.fair-rite.com/kit

Shield Bead Kit

Part Number	Kit Description
0199000019	Contains 28 different beads in three suppression materials, 73, 43 and 61.

73 Matl (< 50 MHz)	Qty
2673000101	15
2673000301	10
2673000501	25
2673000801	5
2673002402	5
2673004801	25
2673021801	5
2673030101	25
2673901301	25

43 Matl (25-300 MHz)	Qty
2643000101	15
2643000201	25
2643000301	10
2643000501	25
2643000801	5
2643001301	10
2643001501	10
2643002402	5
2643004801	25
2643021801	10
2643022401	10
2643250402	5
2643300101	5
2643375102	5

61 Matl (250-1000 MHz)	Qty
2661000101	15
2661000301	10
2661000801	5
2661021801	10
2661375102	5

Antenna/RFID Kit

Part Number	Kit Description
0199000024	Contains a range of rods in three low losses, high Q materials, 78, 61 and 67 to cover frequencies from 10 kHz to 50 MHz.

78 Matl (< 200 kHz)	Qty
3078990821	50
3078990831	25
3078990841	25
3078990851	20
3078990861	15
3078990871	15
3078990881	10
3078990891	8
3078990901	5
3078990911	3

61 Matl (200 kHz-5 MHz)	Qty
3061990821	50
3061990831	25
3061990841	25
3061990851	20
3061990861	15
3061990871	15
3061990881	10
3061990891	8

67 Matl (> 5 MHz)	Qty
3067990821	50
3067990831	25
3067990841	25
3067990851	20
3067990861	15
3067990871	15
3067990881	10

Quick Link: www.fair-rite.com/kit

Surface Mount Bead Kit

Part Number	Kit Description
0199000025	Contains an assortment of surface mount beads for differential and common-mode applications in 73 material for < 50 MHz, 43/44 material for 25-300 MHz and 52/61 material for 250-1000 MHz frequencies.

73 Matl (< 50 MHz) Differential Mode	Qty
2773019447	12
2773021447	12
43/44 Matl (25-300 MHz) Differential Mode	Qty
2743019447	12
2743021447	12
2743037447	12
2744044447	12
2744555567	5
2744555577	6

44 Matl (25-300 MHz) Common-Mode	Qty
2744041447	12
2744045447	12
2744051447	5
2744065447	5
52/61 Matl (250-1000 MHz) Differential Mode	Qty
2761019447	12
2761021447	12
2752555567	5
2752555577	6

52 Matl (250-1000 MHz) Common-Mode	Qty
2752041447	12
2752045447	12
2752051447	5
2752065447	5

Wound Bead Kit

Part Number	Kit Description
0199000027	Contains twelve wound beads in two suppression materials, 44 and 61, wound in several configurations.

44 Matl (1-200 MHz)	Turns	Qty
2944666631	3	8
2944666651	2	8
2944666661	1½	8
2944666671	2½	8
2944666681	2 x 1½	8
2944777721	2 x 2½	4
2944777741	4½	4

61 Matl (50-500 MHz)	Turns	Qty
2961666631	3	8
2961666651	2	8
2961666661	1½	8
2961666671	2½	8
2961666681	2 x 1½	8

Quick Link: www.fair-rite.com/kit

Bead-on-Lead Kit

Part Number	Kit Description
0199000028	Contains three parts each in three materials, 73, 43 and 61, for through hole applications.

73 Matl (< 50 MHz)	Qty
2773001112	15
2773002112	15
2773009112	15

43 Matl (25-300 MHz)	Qty
2743001112	15
2743002112	15
2743009112	15

61 Matl (250-1000 MHz)	Qty
2761001112	15
2761002112	15
2761009112	15

RF Power Rod Kit

Part Number	Kit Description
0199000029	Contains a selection of rod sizes intended for differential mode high current applications that require high saturation and Curie temperature.

52 Matl Rods	Qty	OD x Lth (mm)
4052077111	20	2.0 x 15.0
4052098411	20	2.5 x 15.0
4052111011	20	3.0 x 20.0
4052155611	15	4.0 x 25.0
4052195211	8	5.0 x 25.0
4052235211	5	6.0 x 30.0
4052251111	5	6.5 x 30.0

77 Matl Rods	Qty	OD x Lth (mm)
4077122011	15	3.2 x 25.4
4077172011	8	4.5 x 22.2
4077296011	5	6.4 x 31.8
4077312911	9	8.0 x 38.1
4077375411	6	9.5 x 41.3

31 Material Snap-It Kit

Part Number	Kit Description
0199000030	Contains a range of parts for different cable diameters. Suggested operating frequency 1-300 MHz.

31 Matl Snap-It Assemblies (1 - 300 MHz)	Qty	Max Cable Diameter mm & inches
0431173951	4	4.90 - 0.193
0431164951	4	4.90 - 0.193
0431164281	4	6.30 - 0.250
0431167281	4	9.85 - 0.388
0431164181	2	12.70 - 0.500
0431176451	1	18.00 - 0.709

Quick Link: www.fair-rite.com/kit

43 Material Snap-It Kit

Part Number	Kit Description
0199000031	Contains Snap-It assemblies suitable for the 25-300 MHz frequency range. Can accommodate cable diameters from 0.250 to 0.591 inches.

43 Matl Snap-It Assemblies (25-300 MHz)	Qty	Max Cable Diameter mm & inches
0443164251	2	6.30 - 0.250
0443625006	2	7.60 - 0.300
0443665806	2	9.20 - 0.362
0443167251	2	9.85 - 0.388
0443164151	2	12.70 - 0.500
0443800506	2	12.80 - 0.504
0443806406	2	15.00 - 0.591

46 Material Core and Snap-It Kit

Part Number	Kit Description
0199000032	Contains a selection of cable cores and Snap-Its in our economical 46 material. This material has similar performance to our 43/44 grade materials over the 25-300 MHz frequency range.

46 Matl (25-300 MHz) Cable Cores	Qty	Max Cable Diameter mm & inches
2646480002	2	4.95 - 0.195
2646540002	2	6.10 - 0.240
2646625102	2	7.65 - 0.300
2646665702	2	9.25 - 0.365
2646102002	2	12.55 - 0.495
Snap-It Assemblies	Qty	Max Cable Diameter mm & inches
0446164951	2	4.90 - 0.193
0446164281	2	6.30 - 0.250
0446167281	2	9.85 - 0.388
0446164181	2	12.70 - 0.500

Quick Link: www.fair-rite.com/kit

61 Material Snap-It Kit

Part Number	Kit Description
0199000033	Contains a selection of 61 material Snap-Its. 61 material is our recommended material for suppressing conducted EMI over the 200-1000 MHz frequency range.

61 Matl Snap-It Assemblies (200 - 1000 MHz)	Qty	Max Cable Diameter mm & inches
0461178181	4	4.10 - 0.161
0461164951	4	4.90 - 0.193
0461164281	4	6.30 - 0.250
0461167281	4	9.85 - 0.388
0461164181	2	12.70 - 0.500

61 & 31 Material Snap-It Kit

Part Number	Kit Description
0199000017	Contains a range of parts for different cable diameters. Suppressor selection is suitable for high frequency (61 material) and low frequency (31 material) applications.

31 Matl Snap-It Assemblies (1 - 300 MHz)	Qty	Max Cable Diameter mm & inches
0431178181	1	4.10 - 0.161
0431164951	1	4.90 - 0.193
0431164281	1	6.30 - 0.250
0431167281	1	9.85 - 0.388
0431164181	1	12.70 - 0.500
0431176451	1	18.00 - 0.709

61 Matl Snap-It Assemblies (200 - 1000 MHz)	Qty	Max Cable Diameter mm & inches
0461178181	1	4.10 - 0.161
0461164951	1	4.90 - 0.193
0461164281	1	6.30 - 0.250
0461167281	1	9.85 - 0.388
0461164181	1	12.70 - 0.500
0461176451	1	18.00 - 0.709

Multi-Aperture Core Kit

Part Number	Kit Description
0199000036	Contains five sizes in four materials, 73, 43, 61 and 67. The 73, 43 and 61 material parts are suggested for suppression applications from 1-1000 MHz. The 61 and 67 material parts can be used in HF broadband and inductive designs from 1 MHz to 100 MHz.

73 Material	Qty
2873002302	20
2873002402	12
2873000302	4
2873000202	2
2873006802	2

43 Material	Qty
2843002302	20
2843002402	12
2843001502	4
2843000202	2
2843006802	2

61 Material	Qty
2861002302	20
2861002402	12
2861001502	4
2861000202	2
2861006802	2

67 Material	Qty
2867002302	20
2867002402	12
2867001502	4
2867000102	2
2867006802	2

Quick Link: www.fair-rite.com/kit

High Frequency Toroid Kit

Part Number	Kit Description
0199000039	This kit contains a selection of popular toroid sizes in Fair-Rite's high frequency materials. These materials are of the NiZn type with Curie Temps above 200° C. These materials are suitable for broadband and inductive applications from 1 to over 100 MHz

Low Permeability 68 Matl (ui=16)	Qty
5968020901	12
5968000201	12
5968000301	6
5968001101	5
5968001801	6
5968021001	5
5968002701	3
5968003801	3

Low Permeability 67 Matl (ui=40)	Qty
5967000101	12
5967000201	12
5967000301	6
5967001101	5
5967001801	6
5967001001	5
5967002701	3
5967003801	3

Low Permeability 61 Matl (ui=125)	Qty
5961000101	12
5961000201	12
5961000301	6
5961001101	5
5961001801	6
5961001001	5
5961002701	3
5961003801	3

Low Permeability 52 Matl (ui=250)	Qty
5952020201	12
5952020301	12
5952020401	6
5952020501	5
5952020601	6
5952020701	5
5952020801	3
5952003801	3

Flex Circuit & Ribbon Cable Core Kit

Part Number	Kit Description
0199000038	This kit contains a selection of single piece and split core geometries for flat cables. All parts are of the 43 Material which provides optimal suppression from 25 to 500 MHz. Sizes range for flat cable widths of 8 to 51 mm.

Part Number	Qty
2643180251	8
2643178351	8
2643169552	8
2643178651	8

Part Number	Qty
2643180351	5
2643178751	6
2643180451	16
2643169351	6

Part Number	Qty
2643180551	6
2643180651	6
2643180751	6
2643180851	12

Part Number	Qty
2643173851	12
2643166851	6
2643170951	6
2643168251	6

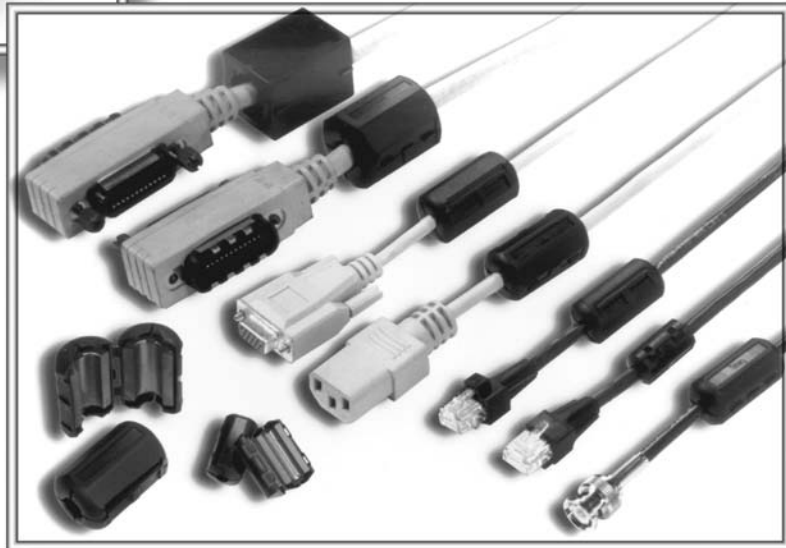
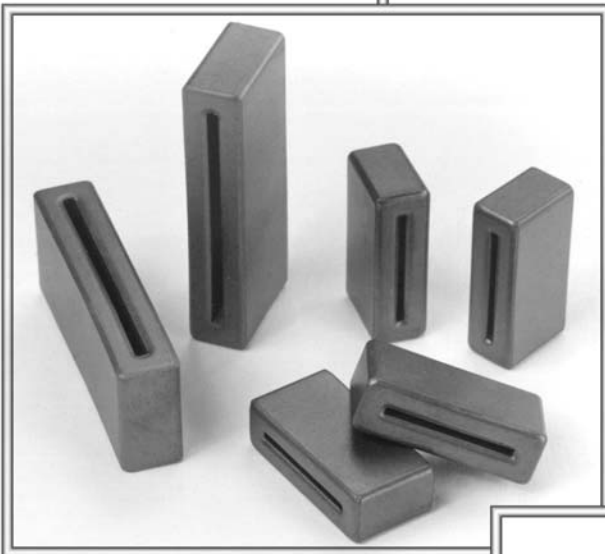

Fair-Rite Products Corp. PO Box 288, One Commercial Row, Wallkill, NY 12589-0288

Phone: (888) FAIR RITE / (845) 895-2055 • Fax: (888) FERRITE / (845) 895-2629 • Web: www.fair-rite.com
(888) 324-7748 (888) 337-7483 E -mail: ferrites@fair-rite.com

Round Cable EMI Suppression Cores

Quick Link: www.fair-rite.com/rcc

Listed by frequency range and in ascending order of "B" dimension.

Fair-Rite offers a broad selection of ferrite EMI suppression cable cores in several materials with guaranteed minimum impedance specifications.

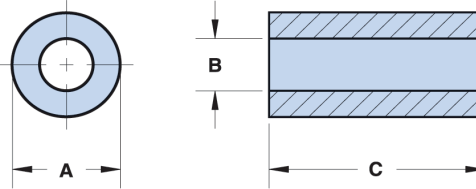

- All cable cores have been burnished to remove the sharp edges.
- The column "H" (Oe) gives for each cable core the calculated dc bias field in oersted for 1 turn and 1 ampere direct current. The actual dc H field in the application, is this value of "H" times the actual NI (ampere-turns) product. For the effect of the dc bias on the impedance of the core material, see the figures 18-23 in the application note "How to Choose Ferrite Components for EMI Suppression".
- Suppression cable cores are controlled for impedances only. Minimum impedance values are specified for the + marked frequencies. The minimum impedance is typically the listed impedance less 20%.
- Single turn impedance tests for 31, 43 and 46 material cores are performed on the 4193A Vector Impedance Meter. The 61 material parts are tested on the 4191A RF Impedance Analyzer and 75 material parts are tested on the 4285A LCR Meter. **Cores are tested with the shortest practical wire length.**
- Performance curves for these suppression components are on our web site.
- For smaller suppression parts, refer to the section "EMI Suppression Beads".
- For any cable suppression core not listed here, feel free to contact our customer service group for availability and pricing.
- The "C" dimension, the core length, can be modified to suit specific applications.
- Our "Expanded Cable and Suppressor Kit" (part number 0199000005) contains a selection of these suppression cores.
- Explanation of Part Numbers: Digits 1&2 = product class, 3&4 = material grade and last digit 2 = burnished.

Legend

Dimensions (Top numbers are in millimeters, bottom numbers are in nominal inches.)

*** Test frequency**

Low Frequency 200 kHz - 30 MHz (75 material)

Part Number	A	B	C	Wt. (g)	H (Oe)	Impedance (Ω)				
						200 kHz	500 kHz	1 MHz	2 MHz	5 MHz
2675023002	9.50 \pm 0.25 0.374	5.10 \pm 0.25 0.201	19.00 \pm 0.45 0.748	4.60	0.58	17	43	68	100	96
2675540202	14.30 \pm 0.45 0.563	6.35 \pm 0.25 0.250	13.45 \pm 0.35 0.530	8.30	0.43	16	39	58	67	52
2675540002	14.30 \pm 0.45 0.563	6.35 \pm 0.25 0.250	28.60 \pm 0.60 1.126	17.70	0.43	30	80	133	154	95
2675625102	15.88 \pm 0.38 0.625	7.90 \pm 0.40 0.311	28.60 \pm 0.60 1.126	20.40	0.36	25	60	83	75	50
2675665702	17.40 \pm 0.40 0.685	9.50 \pm 0.40 0.374	28.60 \pm 0.60 1.126	23.00	0.32	22	56	102	138	85

Fair-Rite Products Corp. PO Box 288, One Commercial Row, Wallkill, NY 12589-0288

Phone: (888) FAIR RITE / (845) 895-2055 • Fax: (888) FERRITE / (845) 895-2629 • Web: www.fair-rite.com
(888) 324-7748 (888) 337-7483 E-mail: ferrites@fair-rite.com

Round Cable EMI Suppression Cores

Quick Link: www.fair-rite.com/rcc

Listed by frequency range and in ascending order of "B" dimension.

Low Frequency 200 kHz - 30 MHz (75 material)

Part Number	A	B	C	Wt. (g)	H (Oe)	Impedance (Ω)				
						200 kHz	500 kHz	1 MHz	2 MHz	5 MHz
2675626402	18.70 \pm 0.50 0.736	10.15 \pm 0.40 0.400	28.60 \pm 0.60 1.126	26.60	0.29	25	62	92	97	67
2675102002	25.90 \pm 0.75 1.020	12.80 \pm 0.25 0.504	28.60 \pm 0.80 1.126	55.00	0.22	30	83	120	70	54
2675821502	31.00 \pm 0.60 1.220	19.00 \pm 0.60 0.748	15.00 \pm 0.30 0.591	34.00	0.17	11	29.5	43	28	20

Lower & Broadband Frequencies 1-300 MHz (31 material)

Part Number	A	B	C	Wt. (g)	H (Oe)	Impedance (Ω)					
						1 MHz	5 MHz	10 MHz ⁺	25 MHz ⁺	100 MHz ⁺	250 MHz
2631250202	6.35 \pm 0.15 0.250	2.95 \pm 0.45 0.125	25.40 \pm 0.75 1.000	2.90	0.91	27	70	90	138	230	240
2631023002	9.50 \pm 0.25 0.375	4.75 \pm 0.30 0.193	19.05 \pm 0.70 0.750	4.70	0.60	19	49	62	95	160	185
2631480102	12.30 \pm 0.40 0.485	4.95 \pm 0.25 0.200	12.70 \pm 0.40 0.500	6.00	0.52	18	45	58	88	140	167
2631480002	12.30 \pm 0.40 0.485	4.95 \pm 0.25 0.200	25.40 \pm 0.75 1.000	12.00	0.52	34	88	115	175	295	267
2631540202	14.30 \pm 0.45 0.562	6.35 \pm 0.25 0.250	13.80 \pm 0.70 0.530	8.30	0.43	17	44	58	88	140	160
2631540002	14.30 \pm 0.45 0.562	6.35 \pm 0.25 0.250	28.60 \pm 0.75 1.125	17.70	0.43	35	91	119	181	300	280
2631625002	16.25 \pm 0.75 0.625	7.90 \pm 0.25 0.312	14.30 \pm 0.35 0.562	10.30	0.36	16	40	53	75	130	150
2631625102	16.25 \pm 0.75 0.625	7.90 \pm 0.25 0.312	28.60 \pm 0.75 1.125	20.50	0.36	30	79	103	156	260	268
2631665702	17.45 \pm 0.40 0.687	9.50 \pm 0.25 0.375	28.60 \pm 0.75 1.125	23.10	0.32	27	69	89	138	225	265
2631626302	18.70 \pm 0.50 0.735	10.15 \pm 0.25 0.400	14.65 \pm 0.75 0.562	13.30	0.29	14	35	44	69	115	140
2631626402	18.70 \pm 0.50 0.735	10.15 \pm 0.25 0.400	28.60 \pm 0.75 1.125	26.60	0.29	27	69	89	138	225	235
2631102002	25.90 \pm 0.75 1.020	12.80 \pm 0.25 0.505	28.60 \pm 0.80 1.125	55.00	0.22	31	79	103	156	260	280
2631101902	28.50 \pm 0.60 1.122	13.80 \pm 0.40 0.543	28.60 \pm 0.80 1.125	68.00	0.21	32	82	106	163	270	300
2631801202	29.00 \pm 0.75 1.142	19.00 \pm 0.50 0.748	13.85 \pm 0.40 0.545	25.00	0.17	10	24	31	49	88	130
2631103002	31.60 \pm 0.75 1.244	19.55 \pm 0.50 0.770	50.80 \pm 1.00 2.000	116.00	0.17	37	98	120	205	340	315
2631626202	50.80 \pm 1.30 2.000	25.40 \pm 0.80 1.000	38.10 \pm 0.75 1.500	278.00	0.11	40	103	140	215	365	290
2631803802	61.00 \pm 1.30 2.400	35.55 \pm 0.85 1.400	12.70 \pm 0.50 0.500	118.00	0.09	12	28	40	63	119	215
2631814002	101.60 \pm 2.60 4.000	76.20 \pm 2.00 3.000	25.40 \pm 0.70 1.000	420.00	0.05	14	31	45	76	175	500

Fair-Rite Products Corp. PO Box 288, One Commercial Row, Wallkill, NY 12589-0288

Round Cable EMI Suppression Cores

Quick Link: www.fair-rite.com/rcc

Listed by frequency range and in ascending order of "B" dimension.

Broadband Frequencies 25-300 MHz (43 material)

Part Number	A	B	C	Wt. (g)	H (Oe)	Impedance (Ω)			
						10 MHz	25 MHz ⁺	100 MHz ⁺	250 MHz
2643480102	12.30 ±0.40 0.485	4.95 +0.25 0.200	12.70 ±0.40 0.500	6.00	0.52	52	84	121	145
2643480002	12.30 ±0.40 0.485	4.95 ±0.25 0.200	25.40 ±0.75 1.000	12.00	0.52	102	165	236	233
2643540702	14.30 ±0.45 0.562	6.35 ±0.25 0.250	5.30 -0.45 0.200	3.10	0.43	20	30	50	68
2643540102	14.30 ±0.45 0.562	6.35 ±0.25 0.250	10.15 ±0.40 0.400	6.30	0.43	39	61	89	104
2643540202	14.30 ±0.45 0.562	6.35 ±0.25 0.250	13.80 -0.70 0.530	8.30	0.43	51	78	118	140
2643540002	14.30 ±0.45 0.562	6.35 ±0.25 0.250	28.60 ±0.75 1.125	17.70	0.43	105	171	250	255
2643540302	14.30 ±0.45 0.562	7.10 ±0.25 0.280	15.25 ±0.40 0.600	8.90	0.41	50	75	118	137
2643800302	12.70 ±0.25 0.500	7.15 ±0.20 0.282	4.90 -0.25 0.188	2.00	0.43	15	26	42	59
2643540402	14.30 ±0.45 0.562	7.25 ±0.20 0.286	28.60 ±0.75 1.125	16.00	0.40	88	143	215	230
2643801102	12.70 ±0.25 0.500	7.90 ±0.20 0.312	6.35 ±0.20 0.250	2.40	0.40	16	26	41	59
2643801902	12.70 ±0.25 0.500	7.90 ±0.20 0.312	12.70 ±0.40 0.500	4.70	0.40	29	44	73	91
2643625002	16.25 -0.75 0.625	7.90 ±0.25 0.312	14.30 ±0.35 0.562	10.30	0.36	45	70	113	135
2643625102	16.25 -0.75 0.625	7.90 ±0.25 0.312	28.60 ±0.75 1.125	20.50	0.36	90	130	213	240
2643625202	15.90 ±0.40 0.625	7.90 ±0.30 0.312	50.80 ±1.00 2.000	36.00	0.36	158	235	384	305
2643665902	17.45 ±0.40 0.687	9.50 ±0.25 0.375	6.35 ±0.25 0.250	5.10	0.32	19	26	44	62
2643665802	17.45 ±0.40 0.687	9.50 ±0.25 0.375	12.70 ±0.50 0.500	10.30	0.32	35	55	88	108
2643665702	17.45 ±0.40 0.687	9.50 ±0.25 0.375	28.60 ±0.75 1.125	23.10	0.32	78	125	200	255
2643626302	18.70 ±0.50 0.735	10.15 ±0.25 0.400	14.65 -0.75 0.562	13.30	0.29	41	63	96	123
2643626402	18.70 ±0.50 0.735	10.15 ±0.25 0.400	28.60 ±0.75 1.125	26.60	0.29	79	128	196	220
2643626502	18.70 ±0.60 0.735	10.15 ±0.40 0.400	50.80 ±1.00 2.000	47.00	0.29	138	225	348	405
2643801502	25.40 ±0.65 1.000	12.70 ±0.35 0.500	6.35 ±0.25 0.250	11.60	0.23	22	34	53	87
2643102402	25.90 ±0.75 1.020	12.80 ±0.25 0.505	21.30 ±0.50 0.840	41.00	0.22	68	110	183	230
2643102002	25.90 ±0.75 1.020	12.80 ±0.25 0.505	28.60 ±0.80 1.125	55.00	0.22	91	145	235	275
2643800602	20.95 ±0.40 0.825	13.20 ±0.30 0.520	6.35 ±0.20 0.250	6.30	0.24	16	24	44	67
2643800502	20.95 ±0.40 0.825	13.20 ±0.30 0.520	11.90 ±0.40 0.468	11.90	0.24	27	45	82	115
2643801802	22.10 ±0.40 0.870	13.70 ±0.30 0.540	6.35 ±0.20 0.250	7.20	0.23	15	25	45	70
2643101902	28.50 ±0.60 1.122	13.80 ±0.30 0.543	28.60 ±0.80 1.125	67.00	0.21	93	145	230	290
2643801402	25.40 ±0.60 1.000	15.50 ±0.50 0.610	8.10 ±0.30 0.320	12.40	0.20	20	35	55	95
2643806402	25.40 ±0.60 1.000	15.50 ±0.50 0.610	12.70 ±0.40 0.500	19.40	0.20	30	53	90	130
2643251002	39.10 ±0.75 1.540	16.75 ±0.50 0.660	22.20 ±0.80 0.875	104.00	0.16	85	135	230	325

Fair-Rite Products Corp. PO Box 288, One Commercial Row, Wallkill, NY 12589-0288

Phone: (888) FAIR RITE / (845) 895-2055 • Fax: (888) FERRITE / (845) 895-2629 • Web: www.fair-rite.com
 (888) 324-7748 (888) 337-7483 E-mail: ferrites@fair-rite.com

Round Cable EMI Suppression Cores

Quick Link: www.fair-rite.com/rcc

Listed by frequency range and in ascending order of "B" dimension.

Broadband Frequencies 25-300 MHz (43 material)

Part Number	A	B	C	Wt. (g)	H (Oe)	Impedance (Ω)			
						10 MHz	25 MHz ⁺	100 MHz ⁺	250 MHz
2643801002	29.00 ±0.75 1.142	19.00 ±0.50 0.748	7.50 ±0.25 0.295	13.60	0.17	17	28	47	80
2643801202	29.00 ±0.75 1.142	19.00 ±0.50 0.748	13.85 ±0.40 0.545	25.10	0.17	28	51	92	142
2643804502	31.10 ±0.75 1.225	19.05 ±0.50 0.750	16.30 -0.75 0.627	36.00	0.17	37	60	100	153
2643103002	31.10 ±0.85 1.225	19.05 ±0.60 0.750	50.80 ±1.00 2.000	116.00	0.17	105	195	330	310
2643802702	35.55 ±0.75 1.400	22.85 ±0.50 0.900	12.70 ±0.50 0.500	36.00	0.14	28	48	80	135
2643626102	50.80 ±1.00 2.000	25.40 ±0.50 1.000	25.40 ±0.75 1.000	190.00	0.11	80	128	224	310
2643625902	50.80 ±1.00 2.000	25.40 ±0.50 1.000	28.70 ±0.75 1.130	215.00	0.11	90	145	254	373
2643626202	50.80 ±1.30 2.000	25.40 ±0.80 1.000	38.10 ±0.75 1.500	285.00	0.11	118	193	336	280
2643626002	50.80 ±1.30 2.000	25.40 ±0.80 1.000	50.80 ±1.00 2.000	380.00	0.11	157	240	360	257
2643803802	61.00 ±1.30 2.400	35.55 ±0.85 1.400	12.70 ±0.50 0.500	118.00	0.09	33	58	108	218
2643814002	101.60 ±2.60 4.000	76.20 ±2.00 3.000	25.40 ±0.70 1.000	420.00	0.05	46	75	169	400

Broadband Frequencies 25-300 MHz (Economical 46 material)

Part Number	A	B	C	Wt. (g)	H (Oe)	Impedance (Ω)			
						10 MHz	25 MHz	100 MHz ⁺	250 MHz
2646480102	12.30 ±0.40 0.485	4.95 ±0.25 0.200	12.70 ±0.40 0.500	6.00	0.52	42	62	110	145
2646480002	12.30 ±0.40 0.485	4.95 ±0.25 0.200	25.40 ±0.75 1.000	12.00	0.52	83	125	212	233
2646540202	14.30 ±0.45 0.562	6.35 ±0.25 0.250	13.80 -0.70 0.530	8.30	0.43	45	66	106	127
2646540002	14.30 ±0.45 0.562	6.35 ±0.25 0.250	28.60 ±0.75 1.125	17.70	0.43	89	134	225	253
2646625002	16.25 -0.75 0.625	7.90 ±0.25 0.312	14.30 ±0.35 0.562	10.30	0.36	44	63	102	135
2646625102	16.25 -0.75 0.625	7.90 ±0.25 0.312	28.60 ±0.75 1.125	20.50	0.36	78	115	192	235
2646625202	15.90 ±0.40 0.625	7.90 ±0.30 0.312	50.80 ±1.00 2.000	36.00	0.36	138	204	345	270
2646665802	17.45 ±0.40 0.687	9.50 ±0.25 0.375	12.70 ±0.50 0.500	10.30	0.32	32	49	79	110
2646665702	17.45 ±0.40 0.687	9.50 ±0.25 0.375	28.60 ±0.75 1.125	23.10	0.32	72	106	180	225
2646626402	18.70 ±0.50 0.736	10.15 ±0.25 0.400	28.60 ±0.75 1.125	26.60	0.29	70	110	170	210
2646102402	25.90 ±0.75 1.020	12.80 ±0.25 0.505	21.30 ±0.50 0.840	41.00	0.22	67	100	165	218
2646102002	25.90 ±0.75 1.020	12.80 ±0.25 0.505	28.60 ±0.80 1.125	55.00	0.22	74	118	212	268
2646101902	28.50 ±0.60 1.122	13.80 ±0.30 0.543	28.60 ±0.80 1.125	67.00	0.21	80	121	207	285
2646804502	31.10 ±0.75 1.225	19.05 ±0.50 0.750	16.30 -0.75 0.627	36.00	0.17	33	49	90	150

Fair-Rite Products Corp. PO Box 288, One Commercial Row, Wallkill, NY 12589-0288

Round Cable EMI Suppression Cores

Quick Link: www.fair-rite.com/rcc

Listed by frequency range and in ascending order of "B" dimension.

Broadband Frequencies 25-300 MHz (Economical 46 material)

Part Number	A	B	C	Wt. (g)	H (Oe)	Impedance (Ω)			
						10 MHz	25 MHz	100 MHz ⁺	250 MHz
2646626202	50.80 \pm 1.30 2.000	25.40 \pm 0.80 1.000	38.10 \pm 0.75 1.500	285.00	0.11	102	165	302	280
2646803802	61.00 \pm 1.30 2.400	35.55 \pm 0.85 1.400	12.70 \pm 0.50 0.500	118.00	0.09	30	44	100	200

Higher Frequencies 200-1000 MHz (61 material)

Part Number	A	B	C	Wt. (g)	H (Oe)	Impedance (Ω)			
						100 MHz	250 MHz ⁺	500 MHz ⁺	1000 MHz
2661480002	12.30 \pm 0.40 0.485	4.95 \pm 0.20 0.200	25.40 \pm 0.75 1.000	12.00	0.52	210	325	395	415
2661540202	14.30 \pm 0.45 0.562	6.35 \pm 0.25 0.250	13.80 -0.70 0.530	8.30	0.43	100	145	185	260
2661540002	14.30 \pm 0.45 0.562	6.35 \pm 0.25 0.250	28.60 \pm 0.75 1.125	17.70	0.43	205	295	370	350
2661801902	12.70 \pm 0.25 0.500	7.90 \pm 0.25 0.312	12.70 \pm 0.40 0.500	4.70	0.40	45	70	105	175
2661665702	17.45 \pm 0.40 0.687	9.50 \pm 0.25 0.375	28.60 \pm 0.75 1.125	23.10	0.32	190	280	360	450
2661626402	19.00 -0.65 0.735	10.15 \pm 0.25 0.400	28.60 \pm 0.75 1.125	26.60	0.29	185	250	370	460
2661102402	25.90 \pm 0.75 1.020	12.80 \pm 0.25 0.505	21.30 \pm 0.50 0.840	41.00	0.22	125	200	310	550
2661102002	25.90 \pm 0.75 1.020	12.80 \pm 0.25 0.505	28.60 \pm 0.80 1.125	55.00	0.22	190	300	380	400

Fair-Rite Products Corp. PO Box 288, One Commercial Row, Wallkill, NY 12589-0288

Phone: (888) FAIR RITE / (845) 895-2055 • Fax: (888) FERRITE / (845) 895-2629 • Web: www.fair-rite.com
 (888) 324-7748 (888) 337-7483 E-mail: ferrites@fair-rite.com

Round Cable Snap-Its



Quick Link: www.fair-rite.com/rcs

Listed by frequency range and in ascending order of cable diameter.

Round cable snap-its can easily accommodate round cables or bundled wires with diameters from 2.5 mm (0.100") to 25.4 mm (1.000"). These assemblies are available in four ferrite material classes to suppress differential or common-mode conducted EMI from 1 MHz into the GHz region. The polypropylene cases are meeting the RoHS restrictions of hazardous substances and have a flammability rating of UL 94 V-0.

- Round cable snap-it assemblies are controlled for impedances only. Minimum impedance values are specified for the + marked frequencies. The minimum impedance is typically the listed impedance less 20%.
- Single turn impedance tests for the 31, 43/44 and 46 material parts are performed on the 4193A Vector Impedance Analyzer. The 61 material parts are tested on the 4291A RF Impedance Analyzer and 75 material parts are tested on the 4285A LCR Meter..
Cores are tested with the shortest practical wire length.
- Performance curves for these suppression components are on our web site.
- Many of the snap-it parts have round core equivalents. See "Round Cable EMI Suppression Cores".
- The "B" dimension is the core inside diameter.
- Round Cable Snap-It Kits are available for each of the four suppression materials. 31 Snap-It Kit (0199000030), 43 Snap-It Kit (0199000031), 46 Core and Snap-It Kit (0199000032) and 61 Snap-It Kit (0199000033).
- Explanation of Part Numbers: Digits 1&2 = product class and 3&4 = material grade.

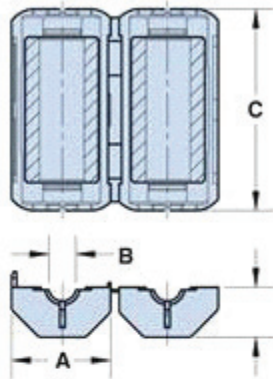

Figure 1

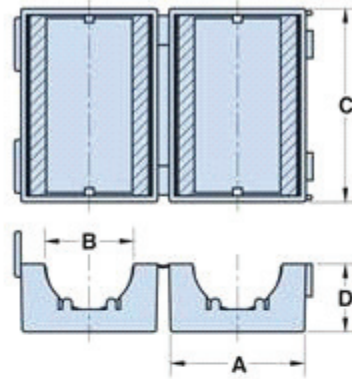

Figure 2

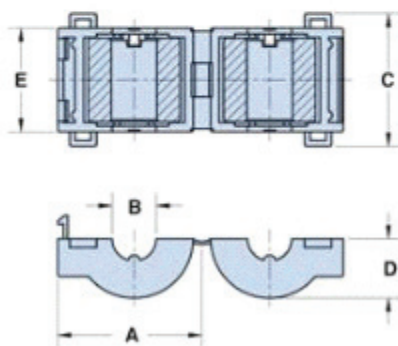

Figure 3

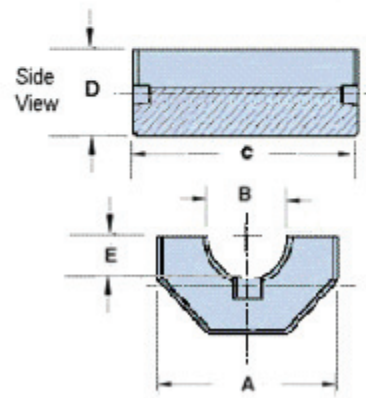

Figure 4

Fair-Rite Products Corp. PO Box 288, One Commercial Row, Wallkill, NY 12589-0288

Round Cable Snap-Its



Quick Link: www.fair-rite.com/rcs

Listed by frequency range and in ascending order of cable diameter.

Legend

Dimensions (Top numbers are in millimeters, bottom numbers are in nominal inches.)

* Test frequency

Low Frequency 200 kHz - 30 MHz (75 material)

Part Number	Fig.	Max. Cable Diameter	A	B	C	D	Wt. (g)	Impedance (Ω)					Solid Equivalent
								200 kHz	500 kHz	1 MHz	2 MHz	5 MHz	
0475181651	2	4.09 0.193	13.00 0.512	5.10 0.201	23.00 0.906	6.05 0.238	6.50	14	35	66	108	110	2675023002
0475164281	1	6.30 0.248	20.00 0.787	6.60 0.260	39.50 1.555	10.00 0.394	26.00	19	49	102	172	110	2675540002
0475178281	1	8.70 0.343	21.00 0.827	9.00 0.354	39.40 1.551	10.50 0.413	23.00	18	46	87	115	74	2675665702
0475167281	1	9.85 0.388	23.00 0.906	10.15 0.400	39.50 1.555	11.70 0.461	33.00	17	47	92	110	67	2675626402
0475164181	1	12.7 0.500	30.00 1.181	13.05 0.514	39.50 1.555	15.50 0.610	61.00	20	58	102	70	50	2675102002
0475176451	1	18.00 0.709	38.50 1.516	18.70 0.736	47.50 1.870	19.15 0.754	161.00	30	92	130	81	66	-

Lower & Broadband Frequencies 1-300 MHz (31 material)

Part Number	Fig.	Max. Cable Diameter	A	B	C	D	Wt. (g)	Impedance (Ω)						Solid Equivalent
								1 MHz	5 MHz	10 MHz ⁺	25 MHz ⁺	100 MHz ⁺	250 MHz	
0431178181	1	4.10 0.161	11.80 0.465	4.30 0.169	23.20 0.913	5.60 0.221	4.20	12	43	60	90	160	183	-
0431173951	1	4.90 0.193	12.80 0.504	5.10 0.201	25.00 0.984	5.60 0.220	6.50	14	44	60	100	180	208	2631023002
0431164951	1	4.90 0.193	17.30 0.680	5.10 0.201	36.20 1.420	8.40 0.331	17.00	25	75	100	169	280	247	2631480002
0431164281	1	6.30 0.250	20.00 0.788	6.60 0.260	39.40 1.550	9.80 0.385	26.00	28	83	105	180	310	240	2631540002
0431178281	1	8.70 0.343	21.50 0.846	9.00 0.354	39.40 1.550	10.55 0.415	23.00	18	63	85	130	250	275	2631665702
0431167281	1	9.85 0.388	23.70 0.933	10.15 0.400	39.40 1.550	11.70 0.461	33.00	18	56	81	144	240	270	2631626402
0431164181	1	12.70 0.500	31.00 1.220	13.05 0.514	39.40 1.550	15.25 0.600	61.00	25	71	100	156	260	260	2631102002
0431176451	1	18.00 0.709	38.60 1.520	18.35 0.722	47.50 1.870	19.15 0.755	161.00	47	95	130	225	380	370	2631103002
0431173551	2	18.50 0.728	29.20 1.150	18.80 0.740	42.00 1.650	14.70 0.579	78.00	16	48	69	125	220	310	-
0431177081	1	25.15 0.990	56.40 2.220	25.65 1.010	42.95 1.690	27.45 1.080	308.00	45	90	125	218	375	340	2631626202
2631181381	4	35.4 1.394	62.10 \pm 1.00 2.445	37.20 \pm 0.64 1.465	63.50 \pm 1.50 2.500	30.20 \pm 0.31 1.190	289.00	60	150	190	290	490	530	-

Broadband Frequencies 25-300 MHz (43 & 44 materials)

Part Number	Fig.	Max. Cable Diameter	A	B	C	D	E	Wt. (g)	Impedance (Ω)				Solid Equivalent
									10 MHz	25 MHz ⁺	100 MHz ⁺	250 MHz	
0443178181	1	4.10 0.161	11.80 0.465	4.30 0.169	23.20 0.913	5.60 0.221	-	4.20	40	70	125	152	-
0444173951	1	4.90 0.193	12.80 0.504	5.10 0.201	25.00 0.984	5.60 0.220	-	6.50	54	94	150	187	2643023002

Fair-Rite Products Corp. PO Box 288, One Commercial Row, Wallkill, NY 12589-0288

Phone: (888) FAIR RITE / (845) 895-2055 • Fax: (888) FERRITE / (845) 895-2629 • Web: www.fair-rite.com
 (888) 324-7748 (888) 337-7483 E-mail: ferrites@fair-rite.com

Round Cable Snap-Its



Quick Link: www.fair-rite.com/rcs

Listed by frequency range and in ascending order of cable diameter.

Broadband Frequencies 25-300 MHz (43 & 44 materials)

Part Number	Fig.	Max. Cable Diameter	A	B	C	D	E	Wt. (g)	Impedance (Ω)				Solid Equivalent
									10 MHz	25 MHz ⁺	100 MHz ⁺	250 MHz	
0444164951	1	4.90 0.193	17.30 0.680	5.10 0.201	36.20 1.420	8.40 0.331	-	17.00	90	144	245	257	2643480002
0443164251	2	6.30 0.250	17.90 0.705	6.60 0.260	32.20 1.270	9.20 0.362	-	31.00	100	163	275	275	2643540002
0444164281	1	6.30 0.250	20.00 0.788	6.60 0.260	39.40 1.550	9.80 0.385	-	26.00	95	156	260	270	2643540002
0443625006	3	7.60 0.299	24.70 0.972	7.90 0.311	22.80 0.898	10.20 0.402	17.80 0.701	13.00	27	50	113	188	2643625002
0443178281	1	8.70 0.343	21.50 0.846	9.00 0.354	39.40 1.550	10.55 0.415	-	24.00	65	120	230	265	2643665702
0443665806	3	9.20 0.362	26.30 1.035	9.50 0.374	21.40 0.843	11.00 0.433	16.40 0.646	13.00	23	41	88	122	2643665802
0443167251	2	9.85 0.388	22.10 0.870	10.15 0.400	32.30 1.272	11.00 0.433	-	42.00	79	138	225	285	2643626402
0444167281	1	9.85 0.388	23.70 0.933	10.15 0.400	39.40 1.550	11.70 0.460	-	33.00	77	125	210	260	2643626402
0443164151	2	12.70 0.500	29.00 1.142	13.05 0.514	32.50 1.280	14.80 0.583	-	84.00	90	156	250	305	2643102002
0444164181	1	12.70 0.500	31.00 1.220	13.05 0.514	39.40 1.550	15.25 0.600	-	61.00	76	138	230	280	2643102002
0443800506	3	12.80 0.504	29.70 1.169	13.20 0.520	20.60 0.811	12.70 0.500	15.60 0.614	16.00	18	35	75	120	2643800502
0443806406	3	15.00 0.591	34.30 1.360	15.50 0.610	21.20 0.835	15.00 0.591	16.20 0.638	23.00	24	43	90	147	2643806402
0444176451	1	18.00 0.709	38.60 1.520	18.35 0.722	47.50 1.870	19.15 0.755	-	161.00	100	175	365	365	2643103002
0444173551	2	18.50 0.728	29.20 1.150	18.80 0.740	42.00 1.650	14.70 0.579	-	78.00	50	95	195	322	2643103102
0444177081	1	25.15 0.990	56.40 2.220	25.65 1.010	42.95 1.690	27.45 1.080	-	308.00	115	194	335	330	2643626202
2644181281	4	33.0 1.300	61.00 \pm 1.30 2.402	37.20 \pm 0.90 1.465	12.70 \pm 0.65 0.500	29.60 \pm 0.35 1.165	16.50 MIN 0.650 MIN	63.00	35	56	104	170	2643803802

Broadband Frequencies 25-300 MHz (Economical 46 material)

Part Number	Fig.	Max. Cable Diameter	A	B	C	D	Wt. (g)	Impedance (Ω)				Solid Equivalent
								10 MHz	25 MHz	100 MHz ⁺	250 MHz	
0446173951	1	4.90 0.193	12.80 0.504	5.10 0.201	25.00 0.984	5.60 0.220	6.50	46	82	135	185	-
0446164951	1	4.90 0.193	17.30 0.680	5.10 0.201	38.20 1.420	8.40 0.331	17.00	72	120	220	250	2646480002
0446164281	1	6.30 0.250	20.00 0.788	6.60 0.260	39.40 1.550	9.80 0.385	26.00	81	131	235	265	2646540002
0446164251	2	6.30 0.250	17.90 0.705	6.60 0.260	32.20 1.270	9.20 0.362	31.00	81	134	245	273	2646540002
0446167281	1	9.85 0.388	23.70 0.933	10.15 0.400	39.40 1.550	11.70 0.460	33.00	66	105	190	275	2646626402
0446167251	2	9.85 0.388	22.10 0.870	10.15 0.400	32.30 1.272	11.00 0.433	42.00	72	116	202	247	2646626402
0446164181	1	12.70 0.500	31.00 1.220	13.05 0.514	39.40 1.550	15.25 0.600	61.00	73	115	205	275	2646102002
0446164151	2	12.70 0.500	29.00 1.142	13.05 0.514	32.50 1.280	14.80 0.583	84.00	84	127	225	270	2646102002
0446176451	1	18.00 0.709	38.60 1.520	18.35 0.722	47.50 1.870	19.15 0.755	161.00	85	137	330	360	-

Fair-Rite Products Corp. PO Box 288, One Commercial Row, Wallkill, NY 12589-0288

Round Cable Snap-Its



Quick Link: www.fair-rite.com/rcs

Listed by frequency range and in ascending order of cable diameter.

Broadband Frequencies 25-300 MHz (Economical 46 material)

Part Number	Fig.	Max. Cable Diameter	A	B	C	D	Wt. (g)	Impedance (Ω)				Solid Equivalent
								10 MHz	25 MHz	100 MHz ⁺	250 MHz	
0446173551	2	18.50 0.728	29.20 1.150	18.80 0.740	42.00 1.650	14.70 0.579	78.00	48	85	176	300	-

Higher Frequencies 200-1000 MHz (61 material)

Part Number	Fig.	Max. Cable Diameter	A	B	C	D	Wt. (g)	Impedance (Ω)				Solid Equivalent
								100 MHz	250 MHz ⁺	500 MHz ⁺	1000 MHz	
0461178181	1	4.10 0.161	11.80 0.465	4.30 0.169	23.20 0.913	5.60 0.221	4.20	115	165	215	300	-
0461164951	1	4.90 0.193	17.30 0.680	5.10 0.201	38.20 1.420	8.40 0.331	17.00	215	325	385	332	2661480002
0461164281	1	6.30 0.250	20.00 0.788	6.60 0.260	39.40 1.550	9.80 0.385	26.00	230	355	425	420	2661540002
0461178281	1	8.70 0.343	21.50 0.846	9.00 0.354	39.40 1.550	10.55 0.415	24.00	180	285	380	430	2661665702
0461167281	1	9.85 0.388	23.70 0.933	10.15 0.400	39.40 1.550	11.70 0.460	33.00	175	275	375	400	2661626402
0461164181	1	12.70 0.500	31.00 1.220	13.05 0.514	39.40 1.550	15.25 0.600	61.00	205	320	435	257	2661102002
0461176451	1	18.00 0.709	38.60 1.520	18.35 0.722	47.50 1.870	19.15 0.755	161.00	360	480	350	110	-

Fair-Rite Products Corp. PO Box 288, One Commercial Row, Wallkill, NY 12589-0288

Phone: (888) FAIR RITE / (845) 895-2055 • Fax: (888) FERRITE / (845) 895-2629 • Web: www.fair-rite.com
 (888) 324-7748 (888) 337-7483 E-mail: ferrites@fair-rite.com

Flat Cable EMI Suppression Cores



Quick Link: www.fair-rite.com/fcc

Listed by frequency range and in ascending order of cable width.

Flat cable suppression core can accommodate multi-conductors flat cables, in widths from 12.7 mm (0.500") up to 77 mm (3.0"). These flat cable cores are available in two ferrite material grades to reduce conducted EMI from 1 MHz to hundreds of MHz.

- Flat cable suppression cores, split or single cores, are controlled for impedances only. Minimum impedance values are specified for the + marked frequencies. The minimum impedance is typically the listed impedance less 20%.
- Centered, single turn impedance tests for the 31 and 43 material parts are performed on the 4193A Vector Impedance Analyzer. **All tests are made with the shortest practical wire length.**
- Performance curves for these suppression components are on our web site.
- Assembly clips are available for most of the split flat cable cores. See section "Flat Cable Cores Assembly clips".
- Our "Expanded Cable & Suppressor Kit" (part number 0199000005) contains a selection of these flat cable cores and clips.
- Flat Cable Cores are available in selected sizes in the "Flex Circuit & Ribbon Cable Core Kit" (part number 0199000038).
- Explanation of Part Numbers: Digits 1&2 = product class and 3&4 = material grade.

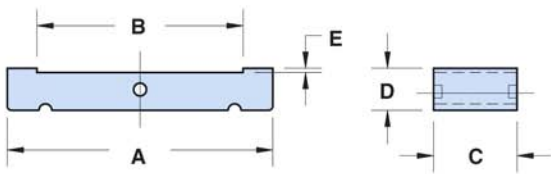

Figure 1

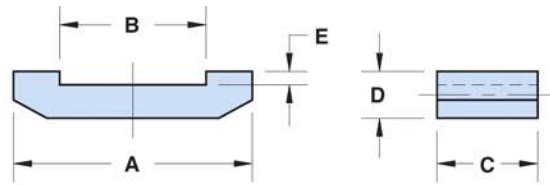

Figure 2

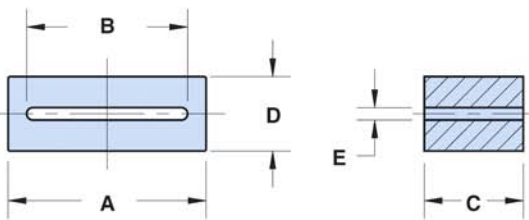

Figure 3

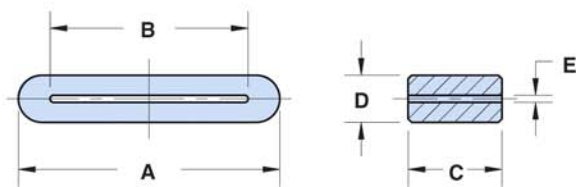

Figure 4

Fair-Rite Products Corp. PO Box 288, One Commercial Row, Walkill, NY 12589-0288

Phone: (888) FAIR RITE / (845) 895-2055 • Fax: (888) FERRITE / (845) 895-2629 • Web: www.fair-rite.com
(888) 324-7748 (888) 337-7483 E -mail: ferrites@fair-rite.com

Flat Cable EMI Suppression Cores



Quick Link: www.fair-rite.com/fcc

Listed by frequency range and in ascending order of cable width.

Legend

Dimensions (Top numbers are in millimeters, bottom numbers are in nominal inches.)

* Test frequency

Lower & Broadband Frequencies 1-300 MHz (31 material)

Part Number	Fig.	Max. Cable Dimensions	A	B	C	D	E	Wt. (g)	Impedance (Ω)					
									1 MHz	5 MHz	10 MHz ⁺	25 MHz ⁺	100 MHz ⁺	250 MHz
2631163851	3	25.90 x 1.50 1.020 x 0.060	38.10 ±1.00 1.500	26.65 ±0.75 1.050	25.40 ±0.75 1.000	12.05 ±0.40 0.475	1.90 ±0.40 0.075	51.00	20	52	68	112	240	440
2631164051	1	64.00 x 1.30 2.520 x 0.050	76.20 ±1.50 3.000	65.30 ±1.30 2.570	28.60 ±0.80 1.125	6.35 ±0.25 0.250	0.85 ±0.20 0.033	60.00	11	34	52	105	310	440

Broadband Frequencies 25-300 MHz (43 material)

Part Number	Fig.	Max. Cable Dimensions	A	B	C	D	E	Wt. (g)	Impedance (Ω)			
									10 MHz	25 MHz ⁺	100 MHz ⁺	250 MHz
2643180251	3	8.90 x 0.60 0.350 x 0.024	13.70 ±0.40 0.539	9.20 ±0.30 0.362	18.00 ±0.40 0.709	5.30 ±0.30 0.209	0.80 ±0.20 0.031	5.60	55	80	130	225
2643180851	1	9.50 x 0.80 0.375 x 0.031	12.80 ±0.40 0.504	9.80 ±0.25 0.386	12.00 ±0.40 0.472	2.10 ±0.20 0.083	0.50 ±0.1 0.020	1.30	22	40	70	100
2643173851	1	12.30 x 1.00 0.484 x 0.039	16.50 ±0.25 0.650	12.50 ±0.20 0.492	10.25 ±0.25 0.404	2.00 ±0.15 0.079	0.63 ±0.13 0.025	1.20	15	28	58	93
2643170251	2	12.20 x 2.30 0.480 x 0.091	22.75 ±0.65 0.895	12.70 ±0.50 0.500	12.70 ±0.50 0.500	3.30 ±0.25 0.125	1.15 ±0.25 0.050	3.50	20	35	70	135
2643178351	4	13.10 x 1.35 0.516 x 0.053	18.50 ±0.40 0.728	13.50 ±0.40 0.531	12.00 ±0.30 0.472	6.60 ±0.25 0.260	1.60 ±0.25 0.063	5.90	31	48	82	140
2643169552	3	13.95 x 0.75 0.549 x 0.030	19.95 ±0.40 0.785	14.20 ±0.25 0.560	10.15 ±0.50 0.400	6.35 ±0.25 0.250	0.90 ±0.15 0.035	5.70	25	40	90	160
2643168751	3	17.30 x 2.30 0.681 x 0.091	25.40 ±0.75 1.000	17.80 ±0.50 0.700	12.70 ±0.40 0.500	10.15 ±0.25 0.400	2.55 ±0.25 0.100	13.00	31	50	95	200
2643173351	4	19.60 x 0.50 0.772 x 0.020	24.50 ±0.40 0.965	20.00 ±0.40 0.787	12.00 ±0.30 0.472	5.00 ±0.25 0.197	0.75 ±0.25 0.030	6.60	23	39	88	157
2643180351	3	20.30 x 0.70 0.799 x 0.027	25.00 ±0.80 0.984	21.00 ±0.70 0.827	12.00 ±0.30 0.472	5.00 ±0.30 0.197	0.80 ±0.10 0.031	6.20	21	36	80	125
2643178651	4	21.10 x 1.35 0.831 x 0.053	26.50 ±0.40 1.043	21.50 ±0.40 0.846	6.00 ±0.30 0.236	6.60 ±0.25 0.260	1.60 ±0.25 0.063	4.10	13	22	50	95
2643178551	4	21.10 x 1.35 0.831 x 0.053	26.50 ±0.40 1.043	21.50 ±0.40 0.846	12.00 ±0.30 0.472	6.60 ±0.25 0.260	1.60 ±0.25 0.063	8.20	24	38	82	155
2643169351	3	27.00 x 1.10 1.063 x 0.043	33.65 ±0.75 1.325	27.50 ±0.50 1.083	13.20 ±0.50 0.520	6.70 ±0.40 0.264	1.35 ±0.25 0.053	12.00	22	37	89	170
2643168651	2	25.40 x 12.20 1.000 x 0.480	38.85 ±0.75 1.530	26.15 ±0.75 1.030	28.60 ±0.70 1.125	13.00 ±0.30 0.512	6.35 ±0.25 0.255	45.00	57	100	188	295
2643164551	3	25.90 x 1.50 1.020 x 0.059	38.10 ±1.00 1.500	26.65 ±0.75 1.050	12.30 ±0.40 0.485	12.05 ±0.40 0.475	1.90 ±0.40 0.075	25.00	33	53	105	215
2643171051	1	25.90 x 1.30 1.020 x 0.051	38.10 ±1.00 1.500	26.65 ±0.75 1.050	12.70 ±0.40 0.500	6.35 ±0.25 0.250	0.85 ±0.20 0.033	14.00	32	53	112	235
2643166851	1	25.90 x 1.30 1.020 x 0.051	38.10 ±1.00 1.500	26.65 ±0.75 1.050	25.40 ±0.75 1.000	6.35 ±0.25 0.250	0.85 ±0.20 0.033	27.00	66	115	235	410
2643163851	3	25.90 x 1.50 1.020 x 0.059	38.10 ±1.00 1.500	26.65 ±0.75 1.050	25.40 ±0.75 1.000	12.05 ±0.40 0.475	1.90 ±0.40 0.075	51.00	64	105	220	385
2643178751	4	26.10 x 1.35 1.028 x 0.053	31.50 ±0.40 1.240	26.50 ±0.40 1.043	12.00 ±0.30 0.472	6.60 ±0.25 0.260	1.60 ±0.25 0.063	9.70	22	37	85	157
2643180451	4	26.30 x 0.70 1.035 x 0.027	31.00 ±1.00 1.220	27.00 ±0.70 1.063	6.00 ±0.30 0.236	5.00 ±0.30 0.197	0.80 ±0.10 0.031	3.90	10.5	20	45	70
2643172551	4	26.50 x 1.25 1.043 x 0.049	33.50 ±0.65 1.319	27.00 ±0.50 1.063	8.00 ±0.40 0.315	6.50 ±0.25 0.256	1.25 ±0.70 0.063	6.80	12	22	58	106

Fair-Rite Products Corp. PO Box 288, One Commercial Row, Wallkill, NY 12589-0288

Phone: (888) FAIR RITE / (845) 895-2055 • Fax: (888) FERRITE / (845) 895-2629 • Web: www.fair-rite.com
 (888) 324-7748 (888) 337-7483 E-mail: ferrites@fair-rite.com

Flat Cable EMI Suppression Cores



Quick Link: www.fair-rite.com/fcc

Listed by frequency range and in ascending order of cable width.

Broadband Frequencies 25-300 MHz (43 material)

Part Number	Fig.	Max. Cable Dimensions	A	B	C	D	E	Wt. (g)	Impedance (Ω)			
									10 MHz	25 MHz ⁺	100 MHz ⁺	250 MHz
2643166451	1	26.95 x 6.10 1.061 x 0.240	38.35 ±1.00 1.510	27.95 ±1.00 1.100	28.60 ±0.70 1.125	9.00 ±0.30 0.355	3.30 ±0.25 0.130	35.00	61	96	185	335
2643168051	1	32.30 x 6.20 1.272 x 0.244	52.90 ±1.00 2.083	33.00 ±0.70 1.299	31.25 ±1.00 1.230	12.50 ±0.40 0.492	3.50 ±0.40 0.138	84.00	81	140	265	400
2643167551	1	32.30 x 6.20 1.272 x 0.244	52.90 ±1.00 2.083	33.00 ±0.70 1.299	63.50 ±1.80 2.500	12.50 ±0.40 0.492	3.50 ±0.40 0.138	170.00	150	270	480	370
2643170951	1	33.70 x 1.30 1.327 x 0.051	45.10 ±0.75 1.775	34.40 ±0.70 1.355	12.70 ±0.40 0.500	6.35 ±0.25 0.250	0.85 ±0.20 0.033	16.00	25	50	115	240
2643166551	3	33.70 x 1.20 1.327 x 0.047	45.10 ±0.75 1.775	34.40 ±0.70 1.355	28.60 ±0.70 1.125	12.45 ±0.40 0.490	1.50 ±0.30 0.060	71.00	67	115	300	415
2643166651	1	33.70 x 1.30 1.327 x 0.051	45.10 ±0.75 1.775	34.40 ±0.70 1.355	28.60 ±0.70 1.125	6.35 ±0.25 0.250	0.85 ±0.20 0.033	36.00	60	110	290	435
2643180551	4	34.10 x 1.05 1.342 x 0.041	40.00 ±1.00 1.575	34.80 ±0.70 1.370	18.00 ±0.40 0.709	6.50 ±0.30 0.256	1.30 ±0.25 0.051	18.00	25	44	110	170
2643180651	4	39.00 x 1.20 1.535 x 0.047	45.20 ±1.00 1.780	40.00 ±1.00 1.575	12.00 ±0.40 0.472	6.50 ±0.30 0.256	1.50 ±0.30 0.059	13.00	17	23	33	160
2643180751	4	51.00 x 1.10 2.008 x 0.043	57.60 ±1.00 2.268	52.00 ±1.00 2.047	12.00 ±0.40 0.472	6.50 ±0.30 0.256	1.40 ±0.30 0.055	17.00	20	33	76	165
2643168251	1	51.00 x 1.30 2.008 x 0.051	63.50 ±1.30 2.500	52.10 ±1.10 2.050	12.70 ±0.40 0.500	6.35 ±0.25 0.250	0.85 ±0.20 0.033	22.00	22	50	125	255
2643163951	1	51.00 x 1.30 2.008 x 0.051	63.50 ±1.30 2.500	52.10 ±1.10 2.050	28.60 ±0.80 1.125	6.35 ±0.25 0.250	0.85 ±0.20 0.033	50.00	56	100	290	400
2643167751	1	64.00 x 1.30 2.520 x 0.051	76.20 ±1.50 3.000	65.30 ±1.30 2.570	12.70 ±0.40 0.500	6.35 ±0.25 0.250	0.85 ±0.20 0.033	27.00	22	45	115	240
2643164051	1	64.00 x 1.30 2.520 x 0.051	76.20 ±1.50 3.000	65.30 ±1.30 2.570	28.60 ±0.80 1.125	6.35 ±0.25 0.250	0.85 ±0.20 0.033	60.00	48	100	290	420
2643168351	1	76.70 x 1.30 3.020 x 0.051	88.90 ±1.80 3.500	78.20 ±1.50 3.080	28.60 ±0.80 1.125	6.50 ±0.35 0.256	0.95 ±0.30 0.037	70.00	45	100	280	440

Fair-Rite Products Corp. PO Box 288, One Commercial Row, Wallkill, NY 12589-0288

Flat Cable Cores Assembly Clips



Quick Link: www.fair-rite.com/fca

Fair-Rite offers several clips to accommodate the assembly of the split flat cable suppression cores.

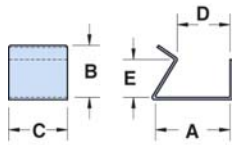

Figure 1

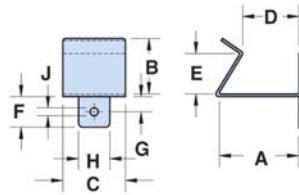

Figure 2

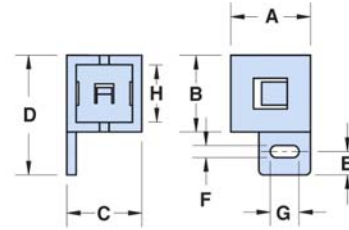

Figure 3

- Figures 1 and 2 are metal clips, made from 0.5 mm (0.020") high carbon steel with a zinc electroplate finish.
- Figure 3 clips are a polypropylene material RoHS compliant, with a flammability rating of UL 94 V-0.

Legend

Dimensions (Top numbers are in millimeters, bottom numbers are in nominal inches.)

Clips

Part Number	Fig.	A	B	C	D	E	F	G	H	J	Flat Cable Cores
0199001401	1	16.10 0.635	11.00 0.433	12.70 0.500	11.40 0.450	8.00 0.315	-	-	-	-	2631164051 2643163951 2643164051 2643166651 2643166851 2643167751 2643168251 2643168351 2643170951 2643171051
0199010301	2	21.20 0.835	11.00 0.433	12.70 0.500	16.50 0.650	8.00 0.315	7.50 0.295	4.00 0.157	6.00 0.236	3.00 0.118	2643166451
0199016051	3	16.70 0.657	15.90 0.626	15.90 0.626	24.60 0.969	4.40 0.171	3.20 0.126	6.40 0.252	13.10 0.516	-	2643167751 2643168251 2643170951 2643171051
0199016551	3	16.70 0.657	32.20 1.270	15.90 0.626	40.50 1.590	4.40 0.171	3.20 0.126	6.40 0.252	29.50 1.161	-	2631164051 2643163951 2643164051 2643166651 2643168351

Fair-Rite Products Corp. PO Box 288, One Commercial Row, Wallkill, NY 12589-0288

Phone: (888) FAIR RITE / (845) 895-2055 • Fax: (888) FERRITE / (845) 895-2629 • Web: www.fair-rite.com
(888) 324-7748 (888) 337-7483 E-mail: ferrites@fair-rite.com

Flat Cable Snap-Its



Quick Link: www.fair-rite.com/fcs

Listed by frequency range and in ascending order of Cable width.

Flat cable snap-its for use on multi-conductor flat cables to suppress common-mode conducted EMI from 1MHz to hundreds of MHz. These flat cable snap-its are available in two ferrite materials, 31 and 43. The polypropylene cases are meeting the RoHS restrictions of hazardous substances and have a flammability rating of UL 94 V-0.

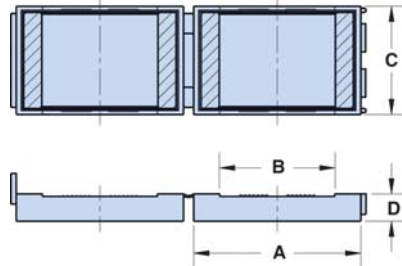

- Flat cable snap-it assemblies are controlled for impedances only. Minimum impedance values are specified for the + marked frequencies. The minimum impedance is typically the listed impedance less 20%.
- Centered, single turn impedance tests on the 31 and 43 material parts are performed on the 4193A Vector Impedance Analyzer. **Cores are tested with the shortest practical wire length.**
- Performance curves for these suppression components are on our web site.
- The “Expanded Cable and Suppressor Kit” (Part number 0199000005) contains several flat cable snap-it assemblies.
- Explanation of Part Numbers: Digits 1&2 = product class and 3&4 = material grade.

Legend

Dimensions (Top numbers are in millimeters, bottom numbers are in nominal inches.)

+ Test frequency

Lower & Broadband Frequencies 1-300 MHz (31 material)

Part Number	Max. Cable Dimensions	A	B	C	D	Wt. (g)	Impedance (Ω)					
							1 MHz	5 MHz	10 MHz ⁺	25 MHz ⁺	100 MHz ⁺	250 MHz
0431163951	51.00 x 1.30 2.000 x 0.050	67.80 2.670	52.10 2.050	32.30 1.272	8.10 0.320	110.00	13	35	54	105	300	425
0431164051	64.00 x 1.30 2.520 x 0.050	80.80 3.180	65.30 2.570	32.30 1.272	8.10 0.320	130.00	11	34	52	105	310	440

Broadband Frequencies 25-300 MHz (43 material)

Part Number	Max. Cable Dimensions	A	B	C	D	Wt. (g)	Impedance (Ω)			
							10 MHz	25 MHz ⁺	100 MHz ⁺	250 MHz
0443166651	33.70 x 1.30 1.325 x 0.050	49.50 1.950	34.40 1.350	32.30 1.272	8.10 0.320	80.00	60	110	290	435
0443163951	51.00 x 1.30 2.000 x 0.050	67.80 2.670	52.10 2.050	32.30 1.272	8.10 0.320	110.00	56	100	290	400
0443164051	64.00 x 1.30 2.520 x 0.050	80.80 3.180	65.30 2.570	32.30 1.272	8.10 0.320	130.00	48	100	290	420

Fair-Rite Products Corp. PO Box 288, One Commercial Row, Wallkill, NY 12589-0288

Connector EMI Suppression Plates



Quick Link: www.fair-rite.com/cp

To provide suppression of conducted EMI at critical interfaces Fair-Rite has available a line of suppression plates that can be used with many types of connectors. All connector plates are supplied in the NiZn 44 grade ideally suited for this application because of its high impedance along with a high resistivity.

- Connector plates are controlled for impedances only. Minimum impedance values are specified for the + marked frequencies. The minimum impedance is typically the listed typical impedance less 20%. Single turn impedance tests are performed on the 4193A Vector Impedance Analyzer, **using the shortest practical wire length**.
- Performance curves for these suppression components are on our web site.
- The “C” dimension can be modified to suit specific applications.
- For any connector EMI suppression plate requirement not listed here, feel free to contact our customer service group for availability and pricing.
- Explanation of Part Numbers: Digit 1&2 = product class and 3&4 = the 44 material grade.

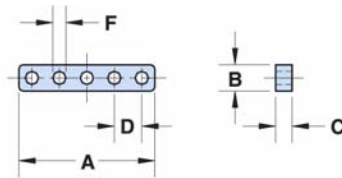

Figure 1

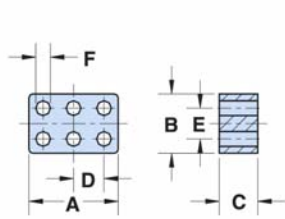

Figure 2

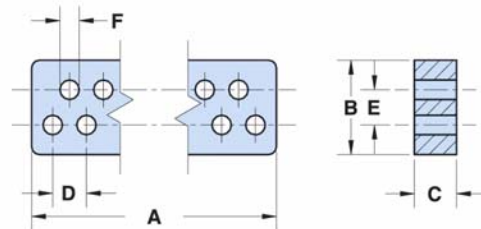

Figure 3

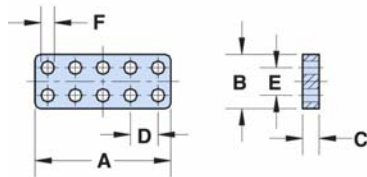

Figure 4

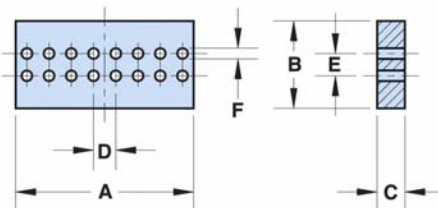

Figure 5

Fair-Rite Products Corp. PO Box 288, One Commercial Row, Wallkill, NY 12589-0288

Phone: (888) FAIR RITE / (845) 895-2055 • Fax: (888) FERRITE / (845) 895-2629 • Web: www.fair-rite.com
(888) 324-7748 (888) 337-7483 E -mail: ferrites@fair-rite.com

Connector EMI Suppression Plates



Quick Link: www.fair-rite.com/cp

Legend

Dimensions (Top numbers are in millimeters, bottom numbers are in nominal inches.)

+ Test frequency

Connector Plates

Part Number	Fig.	Holes	Rows	A	B	C	D	E	F	Wt. (g)	Impedance (Ω)	
											25 MHz ⁺	100 MHz ⁺
2644246701	1	5	1	12.52 ±0.13 0.493	2.54 Max 0.100 Max	1.52 ±0.13 0.060	2.54 ±0.13 0.100	-	1.22 ±0.07 0.048	0.18	13	28
2644246201	2	6	2	5.86 ±0.10 0.231	3.86 ±0.10 0.152	1.52 ±0.13 0.060	2.00 ±0.08 0.079	2.00 ±0.08 0.079	0.82 ±0.10 0.034	0.14	14	28
2644245701	2	6	2	7.44 ±0.10 0.293	4.90 ±0.10 0.193	1.52 ±0.13 0.060	2.54 ±0.13 0.100	2.54 ±0.10 0.100	1.22 ±0.07 0.048	0.22	13	28
2644236101	3	9	2	14.40 ±0.15 0.567	7.75 -0.25 0.300	3.43 ±0.13 0.135	2.75 ±0.13 0.108	2.85 ±0.13 0.112	1.60 ±0.08 0.062	1.60	30	51
2644236401	3	9	2	14.40 ±0.15 0.567	7.75 -0.25 0.300	6.86 ±0.13 0.270	2.75 ±0.13 0.108	2.85 ±0.13 0.112	1.60 ±0.08 0.062	3.20	56	91
2644247001	4	10	2	12.52 ±0.13 0.493	4.94 ±0.14 0.194	1.52 ±0.13 0.060	2.54 ±0.13 0.100	2.54 ±0.10 0.100	1.22 ±0.07 0.048	0.37	13	28
2644247101	4	10	2	12.52 ±0.13 0.493	4.94 ±0.14 0.194	3.05 ±0.13 0.120	2.54 ±0.13 0.100	2.54 ±0.10 0.100	1.22 ±0.07 0.048	0.74	23	40
2644236301	3	15	2	22.55 ±0.25 0.888	7.75 -0.25 0.300	3.43 ±0.13 0.135	2.75 ±0.13 0.108	2.85 ±0.13 0.112	1.60 ±0.08 0.062	2.40	30	51
2644236501	3	15	2	22.55 ±0.25 0.888	7.75 -0.25 0.300	6.86 ±0.13 0.270	2.75 ±0.13 0.108	2.85 ±0.13 0.112	1.60 ±0.08 0.062	4.90	56	91
2644373941	5	16	2	21.60 ±0.25 0.850	11.65 -0.40 0.451	1.52 ±0.13 0.060	2.54 ±0.13 0.100	7.62 ±0.15 0.300	1.00 ±0.15 0.042	2.90	19	36
2644373841	5	16	2	20.30 ±0.25 0.800	10.15 -0.40 0.392	3.18 ±0.13 0.125	2.54 ±0.13 0.100	2.54 ±0.10 0.100	1.22 ±0.07 0.048	2.80	30	51
2644236001	3	25	2	36.30 ±0.40 1.430	7.75 -0.25 0.300	3.43 ±0.13 0.135	2.75 ±0.13 0.108	2.85 ±0.13 0.112	1.60 ±0.08 0.062	3.60	30	51
2644236601	3	25	2	36.30 ±0.40 1.430	7.75 -0.25 0.300	6.86 ±0.13 0.270	2.75 ±0.13 0.108	2.85 ±0.13 0.112	1.60 ±0.08 0.062	7.20	56	91

Fair-Rite Products Corp. PO Box 288, One Commercial Row, Wallkill, NY 12589-0288

Quick Link: www.fair-rite.com/msc

Fair-Rite has tooled several special core geometries in the 43 & 77 material for suppression of conducted EMI.

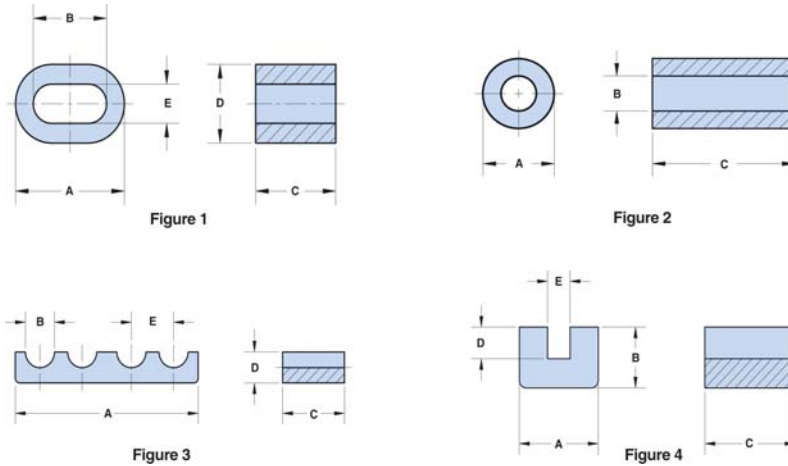

- These suppression cores are controlled for impedance only. The minimum impedance is typically the listed impedance less 20%. Single turns tests are performed on the 4193A Vector Impedance Analyzer **with the shortest practical wire length.**
- Performance curves for these suppression components are on our web site.
- For any non-catalog suppression core design feel free to contact our customer service or application group for feasibility and availability.
- The “C” dimension, the core length, can be modified to suit specific applications.
- Explanation of Part Numbers: Digits 1&2 = product class and 3&4 = the material grade.

Legend

Dimensions (Top numbers are in millimeters, bottom numbers are in nominal inches.)

* Test frequency

Parts for Fig's 3 & 4 tested in pairs

Broadband Frequencies 25-300 MHz (43 material)

Part Number	Fig.	A	B	C	D	E	Wt. (g)	Impedance (Ω)			
								10 MHz	25 MHz ⁺	100 MHz ⁺	250 MHz
2643167851	1	38.85 \pm 0.75 1.530	26.15 \pm 0.75 1.030	28.60 \pm 0.70 1.125	26.00 \pm 0.60 1.025	12.95 \pm 0.25 0.510	85.00	60	94	169	250
2643165151	3	82.60 \pm 1.60 3.250	13.10 \pm 0.30 0.516	28.00 \pm 0.70 1.100	12.95 \pm 0.25 0.510	19.05 \pm 0.40 0.750	109.00	100	163	280	340
2643175451	4	17.80 \pm 0.40 0.700	12.70 \pm 0.50 0.500	20.32 \pm 0.50 0.800	6.60 \pm 0.25 0.260	5.08 \pm 0.25 0.200	19.00	75	119	180	270

Lower Frequencies < 50 MHz (77 material)

Part Number	Fig.	A	B	C	Wt. (g)	Impedance (Ω)		
						1 MHz	10 MHz ⁺	25 MHz ⁺
2677006302	2	9.50 \pm 0.25 0.375	4.75 \pm 0.30 0.193	10.40 \pm 0.25 0.410	2.20	25	40	33
2677102402	2	25.90 \pm 0.75 1.020	12.80 \pm 0.25 0.505	21.30 \pm 0.50 0.840	41.00	52	25	23

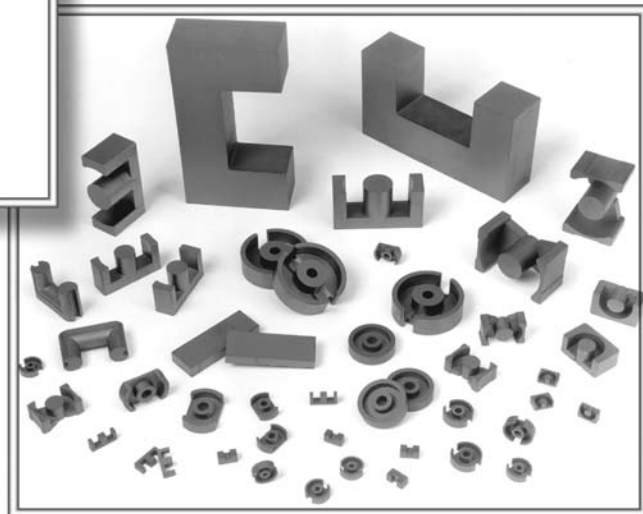
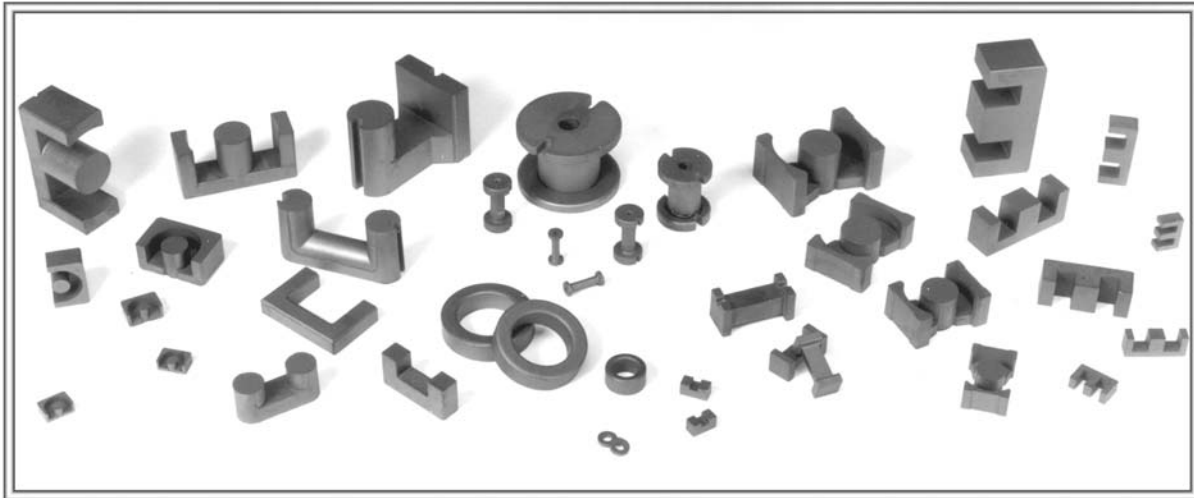

Quick Link: www.fair-rite.com/rod

Pressed Fair-Rite rods are used extensively in high-energy storage designs. These rods can also be used for inductive components that require temperature stability or have to accommodate large dc bias requirements.

- The “A” dimension can be centerless ground to tighter tolerances.
- Figure 2 rods have a 0.6 mm (0.024”) maximum chamfer on the end faces.
- For frequency tuned rod designs see section “Antenna/RFID Rods”.
- For any rod requirement not listed here, feel free to contact our customer service group for availability and pricing.
- Explanation of Part Numbers: Digits 1&2 = product class, 3&4 = material grade.

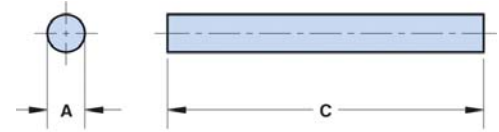

Figure 1

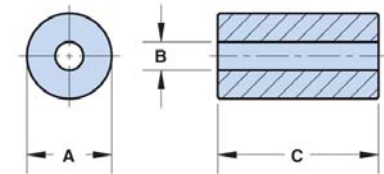

Figure 2

Legend

Dimensions (Top numbers are in millimeters, bottom numbers are in nominal inches.)

Low Permeability, 61($\mu_i=125$) material

Part Number	Fig.	A	C	Wt. (g)
4061272011	1	6.35 ±0.25 0.250	19.05 ±0.75 0.750	2.90
4061287011	1	6.35 ±0.25 0.250	22.10 ±0.70 0.870	3.40
4061276011	1	6.35 ±0.25 0.250	25.40 ±0.70 1.000	3.90
4061266011	1	6.35 ±0.25 0.250	38.10 ±0.75 1.500	5.80
4061378111	1	9.50 ±0.30 0.374	25.40 ±0.80 1.000	8.60
4061375411	1	9.50 ±0.30 0.374	41.30 ±0.80 1.626	14.00

Low Permeability, High Saturation 52 ($\mu_i=250$) material

Part Number	Fig.	A	C	Wt. (g)
4052077111	1	2.00 ±0.13 0.079	15.00 ±0.45 0.591	0.23
4052098411	1	2.50 ±0.13 0.098	15.00 ±0.45 0.591	0.36
4052111011	1	3.00 ±0.13 0.118	20.00 ±0.60 0.787	0.69
4052155611	1	4.00 ±0.15 0.157	25.00 ±0.70 0.984	1.54
4052195211	1	5.00 ±0.20 0.197	25.00 ±0.70 0.984	2.40
4052235211	1	6.00 ±0.25 0.236	30.00 ±0.75 1.181	4.10
4052251111	1	6.50 ±0.25 0.256	30.00 ±0.75 1.181	4.80

Temperature Stable, 33 (μ i=600) material

Part Number	Fig.	A	C	Wt. (g)
4033129021	1	3.25 -0.25 0.125	12.70 ±0.40 0.500	0.50
4033122011	1	3.25 -0.25 0.125	25.40 ±0.75 1.000	0.90
4033276011	1	6.35 ±0.25 0.250	25.40 ±0.75 1.000	3.90
4033266011	1	6.35 ±0.25 0.250	38.10 ±0.75 1.500	5.80

Medium Permeability, 77 (μ i=2000) & 78 (μ i=2300) materials

Part Number	Fig.	A	B	C	Wt. (g)
4077122011	1	3.25 -0.25 0.125	–	25.40 ±0.75 1.000	1.00
4077172011	1	4.60 -0.30 0.175	–	22.20 ±0.75 0.875	1.70
4077272011	1	6.35 ±0.25 0.250	–	19.05 ±0.75 0.750	2.90
4077276011	1	6.35 ±0.25 0.250	–	25.40 ±0.75 1.000	3.80
4077292011	1	6.35 ±0.25 0.250	–	28.60 ±0.75 1.125	4.40
4077296011	1	6.35 ±0.25 0.250	–	31.75 ±0.75 1.250	4.80
4077266011	1	6.35 ±0.25 0.250	–	38.10 ±0.75 1.500	5.80
4077312911	1	8.00 ±0.35 0.315	–	38.10 ±0.75 1.500	9.20
4077374711	1	9.45 ±0.20 0.372	–	31.75 ±0.75 1.250	11.00
4078375111	1	9.45 ±0.20 0.372	–	38.10 ±0.75 1.500	13.00
4077375411	1	9.45 ±0.20 0.372	–	41.30 ±0.80 1.625	14.00
4077375211	1	9.45 ±0.20 0.372	–	50.80 ±1.00 2.000	17.00
4078377511	1	9.50 ±0.25 0.374	–	70.00 ±1.50 2.756	24.00
4077485111	1	12.30 ±0.40 0.485	–	31.75 ±0.75 1.250	18.00
4077484611	1	12.30 ±0.40 0.485	–	41.30 ±0.80 1.625	27.00
4277142009	2	9.00 ±0.30 0.354	3.20 ±0.10 0.126	13.50 ±0.30 0.532	3.60
4277242409	2	13.00 ±0.30 0.512	3.20 ±0.10 0.126	17.50 ±0.40 0.690	10.00
4278282509	2	17.00 ±0.40 0.670	4.20 ±0.15 0.165	18.95 ±0.45 0.746	19.40
4277352509	2	21.00 ±0.50 0.825	6.90 ±0.40 0.272	18.95 ±0.45 0.746	28.00
4277353509	2	21.00 ±0.50 0.825	6.90 ±0.40 0.272	29.00 ±0.60 1.140	43.00
4278453509	2	27.00 ±0.50 1.063	9.00 ±0.30 0.354	27.00 ±0.60 1.064	66.00

Rod Information

Figure 1 shows the rod permeability as a function of the length to diameter ratio for the six materials available in rods.

Figures 3, 4 and 5 illustrate typical temperature behavior of wound rods. Wound rods in 33 and 77 material yield the best temperature stable inductors, see Figure 4. Both show a typical inductance change of < 1% over the -40° to 120°C temperature range. The parts have a L/D ratio of 8.1. Lower ratios will change less. This is shown in detail in Figure 5 for the same 52 material but with the L/D ratio as the parameter. A lower ratio means a lower rod permeability but with improved temperature stability.

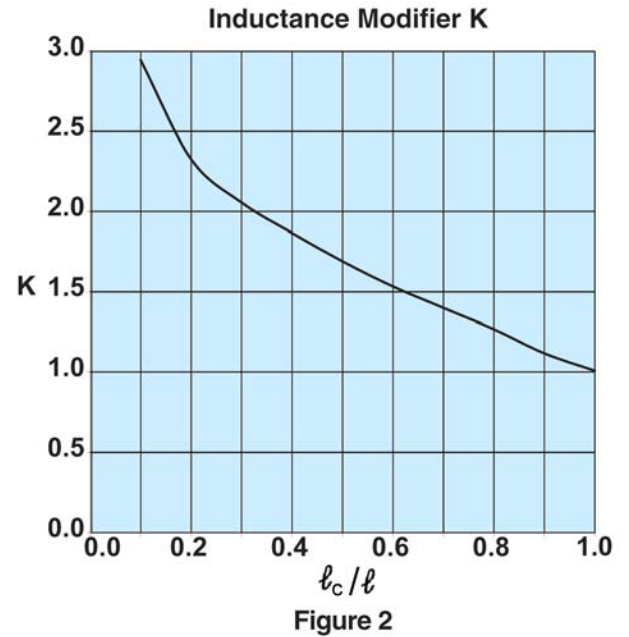
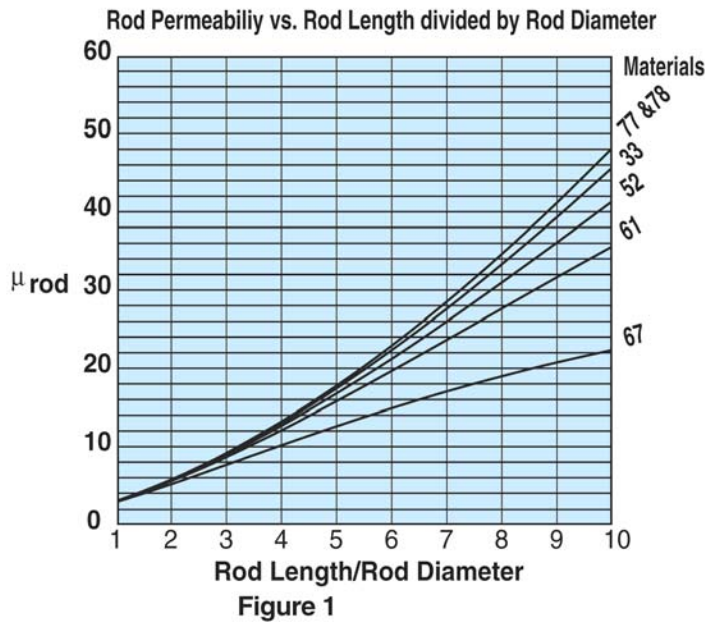

Wound Rod Inductance Calculations

To calculate the inductance of a wound rod the following formula can be used,

$$L = K \mu_0 \mu_{rod} \frac{N^2 A_e}{l} 10^4 (\mu H)$$

Where: K = Inductance modifier

$$\mu_0 = 4\pi 10^{-7}$$

μ_{rod} = rod permeability found in Figure 1.

N = Number of turns

A_e = Cross sectional area of the rod (cm²)

l = Length of the rod (cm)

l_c = Length of the winding (cm)

Rod Information

The inductance modifier is found in Figure 2. The ratio winding length divided by the rod length will give the inductance modifier. If the rod is totally wound the $K = 1$. Shorter but centered windings will yield higher K values.

Using the rod 3061990871 as an example.

For this rod the length over diameter ratio is 8.33 and for 61 material Figure 1 gives a μ_{rod} of 29. The rod has an $A_e = 0.0707 \text{ cm}^2$ and $l = 2.5 \text{ cm}$.

A winding of 80 turns of 30 AWG wire will yield a fully wound rod, therefore $K = 1$.

Using the formula the calculated inductance is $65.96 \mu\text{H}$.

The same rod but wound with 50 turns of the 30 AWG wire has a winding length of 1.5 cm. The inductance modifier is $1.5/2.5 = 0.60$, which results from Figure 2 in a K value of 1.51.

Again with the formula we calculated an inductance of $38.9 \mu\text{H}$.

The measured values for both windings were 66.95 and $39.50 \mu\text{H}$ respectively.

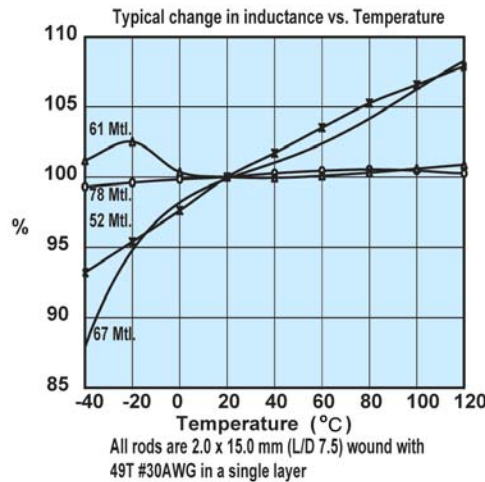

Figure 3

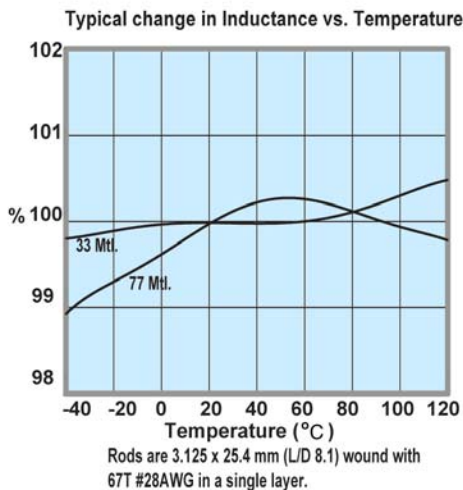

Figure 4

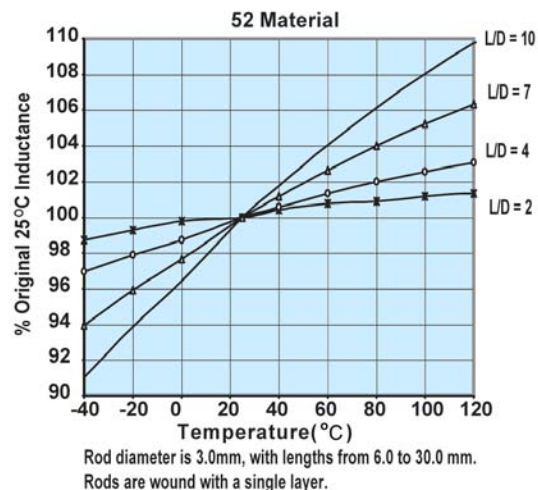
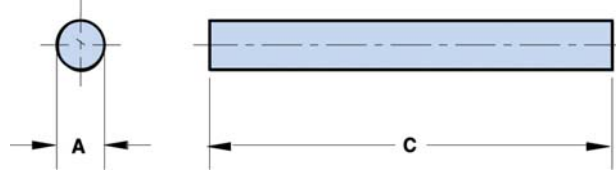

Figure 5

Quick Link: www.fair-rite.com/rfid

These rods are designed for use in antenna and RFID transponder applications. Rods are available in three materials to cover a frequency range from 50 kHz to 25 MHz. Suggested frequency ranges: 78 material < 200 kHz, 61 material 0.2 - 5.0 MHz and 67 material > 5.0 MHz.



- See graphs with temperature information of these rods in the rod information section.
- Rods can be supplied with a Parylene C coating. Parylene coated rods have a “4” as the last digit. Parylene C is RoHS compliant.
- For any rod requirement not listed here, feel free to contact our customer service group for availability and pricing.
- The "Antenna/RFID Kit" (part number 0199000024) contains a selection of these rods.
- Explanation of Part Numbers: Digits 1&2 = product class, 3&4 = material grade, the last digit 1 = uncoated rod and 4 = Parylene coated rod.

Legend

Dimensions (Top numbers are in millimeters, bottom numbers are in nominal inches.)

Low Permeability, 67 ($\mu_i=40$) material

Part Number	A	C	μ_{ROD}	Wt. (g)	$A_e(\text{cm}^2)$
3067990821	0.75 \pm 0.025 0.030	7.50 \pm 0.25 0.295	22	0.02	0.00442
3067990831	1.00 \pm 0.025 0.039	10.00 \pm 0.30 0.394	22	0.04	0.00785
3067990841	1.50 \pm 0.025 0.059	15.00 \pm 0.45 0.591	22	0.13	0.0177
3067990851	2.00 \pm 0.025 0.079	15.00 \pm 0.45 0.591	18	0.23	0.0314
3067990861	2.50 \pm 0.025 0.098	20.00 \pm 0.60 0.787	19	0.47	0.0491
3067990871	3.00 \pm 0.04 0.118	25.00 \pm 0.70 0.984	20	0.85	0.0707
3067990881	4.00 \pm 0.04 0.157	30.00 \pm 0.75 1.181	18	1.80	0.126

Low Permeability, 61 ($\mu_i=125$) material

Part Number	A	C	μ_{ROD}	Wt. (g)	$A_e(\text{cm}^2)$
3061990821	0.75 \pm 0.025 0.030	7.50 \pm 0.25 0.295	35	0.02	0.00442
3061990831	1.00 \pm 0.025 0.039	10.00 \pm 0.30 0.394	35	0.04	0.00785
3061990841	1.50 \pm 0.025 0.059	15.00 \pm 0.45 0.591	35	0.13	0.0177
3061990851	2.00 \pm 0.025 0.079	15.00 \pm 0.45 0.591	25	0.23	0.0314
3061990861	2.50 \pm 0.025 0.098	20.00 \pm 0.60 0.787	27	0.47	0.0491
3061990871	3.00 \pm 0.04 0.118	25.00 \pm 0.70 0.984	29	0.85	0.0707
3061990881	4.00 \pm 0.04 0.157	30.00 \pm 0.75 1.181	25	1.80	0.126
3061990891	5.00 \pm 0.04 0.197	35.00 \pm 0.80 1.378	24	3.30	0.196
3061990901	6.00 \pm 0.05 0.236	40.00 \pm 0.80 1.575	22	5.40	0.283
3061990911	8.00 \pm 0.05 0.315	45.00 \pm 0.90 1.772	18	11.90	0.503

Medium Permeability, 78 ($\mu_i=2300$) material

Part Number	A	C	μ_{ROD}	Wt. (g)	$A_e(\text{cm}^2)$
3078990821	0.75 \pm 0.025 0.030	7.50 \pm 0.25 0.295	48	0.02	0.00442
3078990831	1.00 \pm 0.025 0.039	10.00 \pm 0.30 0.394	48	0.04	0.00785
3078990841	1.50 \pm 0.025 0.059	15.00 \pm 0.45 0.591	48	0.13	0.0177
3078990851	2.00 \pm 0.025 0.079	15.00 \pm 0.45 0.591	31	0.23	0.0314
3078990861	2.50 \pm 0.025 0.098	20.00 \pm 0.60 0.787	34	0.47	0.0491
3078990871	3.00 \pm 0.04 0.118	25.00 \pm 0.70 0.984	36	0.85	0.0707
3078990881	4.00 \pm 0.04 0.157	30.00 \pm 0.75 1.181	31	1.80	0.126
3078990891	5.00 \pm 0.04 0.197	35.00 \pm 0.80 1.378	29	3.30	0.196
3078990901	6.00 \pm 0.05 0.236	40.00 \pm 0.80 1.575	26	5.40	0.283
3078990911	8.00 \pm 0.05 0.315	45.00 \pm 0.90 1.772	20	11.90	0.503

Quick Link: www.fair-rite.com/bob

Bobbins are an economical and well-proven core design for many applications where relatively low but stable inductance values are required.

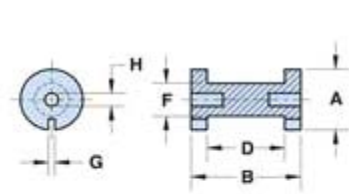

Figure 1

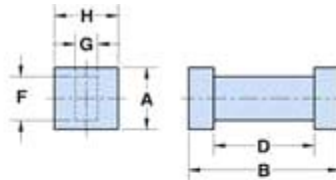

Figure 2

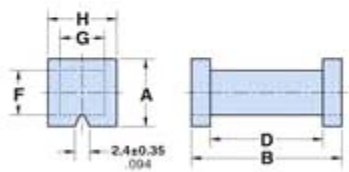

Figure 3

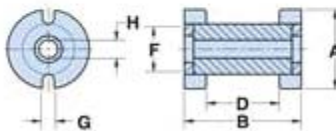

Figure 4

- For higher frequency designs, use small bobbins in 43 material.
- For power applications, bobbins in 77 material are specified for A_L and dc bias limits.
- Bobbins in Figures 2-5 can be supplied with a uniform thermo-set plastic coating which can withstand a minimum breakdown of 500Vrms. This coating will change the dimensions a maximum of 0.5 mm (0.020"). The last digit of the thermo-set plastic coated part is an "8".
- The listed dimensions are for assembled bobbins without thermo-set plastic.
- Bobbins are tested for A_L value at 1kHz < 10 gauss.
- For any bobbin requirement not listed in the catalog, please contact our customer service group for availability and pricing,
- Explanation of Part Numbers: Digits 1&2 = product class, 3&4 = material grade, last digit 8 = coated bobbin.

Quick Link: www.fair-rite.com/bob

Legend: Symbols & Definition

Dimensions (Top numbers are in millimeters, bottom numbers are in nominal inches.)

A_L : Inductance Factor ($\frac{L}{N^2}$), NI : Value of dc Ampere-turns, A_W : Winding Area, N/AWG : Number of Turns / Wire Size for Test Coil

High Frequency Designs

Row #	Part Number	Fig.	A	B	D	F	G	H	Wt. (g)
(1)	9643001165	1	5.05 -0.15 0.196	12.70 ±0.25 0.500	10.00 +0.30 0.400	2.65 +0.10 0.107	0.50 ±0.10 0.020	1.00 +0.10 0.042	1.30
(2)	9643001015	1	9.55 -0.15 0.373	19.00 ±0.70 0.750	12.70 ±0.15 0.500	4.65 +0.20 0.187	1.00 +0.25 0.045	1.03 +0.10 0.043	6.70
(3)	9843000104	2	8.05 ±0.20 0.317	19.00 ±0.40 0.750	12.70 ±0.25 0.500	5.55 +0.25 0.225	2.70 +0.25 0.111	8.05 ±0.20 0.317	3.00

Table Continued ...

Row #	Part Number	A_L (nH)	A_L min. @ NI(At)	N/AWG	A_W (cm ²)
(1)	9643001165	17.5 ±10%	-	30/24	0.12
(2)	9643001015	38.0 ±10%	-	75/24	0.30
(3)	9843000104	38.0 ±10%	-	50/28	0.33

Power Applications

Row #	Part Number	Fig.	A	B	D	F	G	H	Wt. (g)
(4)	9677001165	1	5.05 -0.15 0.196	12.70 ±0.25 0.500	10.00 +0.30 0.400	2.65 +0.10 0.107	0.50 ±0.10 0.020	1.00 +0.10 0.042	1.30
(5)	9677001015	1	9.55 -0.15 0.373	19.00 ±0.70 0.750	12.70 ±0.15 0.500	4.65 +0.20 0.187	1.00 +0.25 0.045	1.03 +0.10 0.043	6.70
(6)	9877000104	2	8.05 ±0.20 0.317	19.00 ±0.40 0.750	12.70 ±0.25 0.500	5.55 +0.25 0.225	2.70 +0.25 0.111	8.05 ±0.20 0.317	3.00
(7)	9877000204	3	11.30 ±0.25 0.445	25.00 ±0.50 0.984	18.95 ±0.45 0.746	7.50 ±0.25 0.295	7.45 ±0.25 0.293	11.40 ±0.40 0.449	8.40
(8)	9677142009	4	14.00 ±0.35 0.551	20.00 ±0.70 0.788	12.50 ±0.30 0.492	9.00 ±0.30 0.354	2.00 ±0.30 0.079	3.20 ±0.10 0.126	8.50
(9)	9677182009	4	18.00 ±0.45 0.709	20.00 ±0.70 0.788	12.50 ±0.30 0.492	11.00 ±0.30 0.433	2.50 ±0.30 0.098	3.20 ±0.10 0.126	13.00
(10)	9677182209	4	18.00 ±0.45 0.709	22.00 ±0.70 0.866	14.50 ±0.35 0.570	11.00 ±0.30 0.433	2.50 ±0.30 0.098	3.20 ±0.10 0.126	14.00
(11)	9677242009	4	24.00 ±0.60 0.945	20.00 ±0.70 0.788	12.50 ±0.30 0.492	13.00 ±0.30 0.512	3.00 ±0.30 0.118	3.20 ±0.10 0.126	22.00
(12)	9677242409	4	24.00 ±0.60 0.945	24.00 ±0.70 0.946	16.50 ±0.40 0.650	13.00 ±0.30 0.512	3.00 ±0.30 0.118	3.20 ±0.10 0.126	24.00
(13)	9677282009	4	28.00 ±0.70 1.102	20.00 ±0.70 0.788	12.50 ±0.30 0.492	17.00 ±0.40 0.670	3.00 ±0.30 0.118	4.20 ±0.15 0.165	33.00
(14)	9677282509	4	28.00 ±0.70 1.102	25.00 ±0.70 0.985	18.00 ±0.45 0.708	17.00 ±0.40 0.670	3.00 ±0.30 0.118	4.20 ±0.15 0.165	38.00
(15)	9677352509	4	35.00 ±0.90 1.381	25.00 ±0.70 0.985	18.00 ±0.45 0.708	21.00 ±0.50 0.825	3.00 ±0.30 0.118	6.90 ±0.40 0.272	56.00
(16)	9677353509	4	35.00 ±0.90 1.381	35.00 ±0.75 1.380	28.00 ±0.60 1.100	21.00 ±0.50 0.825	3.00 ±0.30 0.118	6.90 ±0.40 0.272	71.00
(17)	9677453509	4	45.00 ±1.00 1.771	35.00 ±0.75 1.380	26.00 ±0.60 1.024	27.00 ±0.50 1.063	3.60 ±0.30 0.142	9.00 ±0.30 0.354	127.00

Quick Link: www.fair-rite.com/bob

Table Continued ...

Row #	Part Number	A _L (nH)	A _L min. @ NI(At)	N/AWG	A _w (cm ²)
(4)	9677001165	18 ±10%	15 - 90	30/24	0.12
(5)	9677001015	39 ±10%	33 - 125	75/24	0.30
(6)	9877000104	39 ±10%	33 - 125	36/24	0.33
(7)	9877000204	49 ±10%	42 - 360	45/24	0.37
(8)	9677142009	55 ±10%	47 - 325	81/28	0.31
(9)	9677182009	66 ±10%	56 - 400	50/20	0.44
(10)	9677182209	65 ±10%	55 - 410	95/22	0.51
(11)	9677242009	88 ±10%	75 - 430	50/18	0.69
(12)	9677242409	84 ±10%	72 - 450	67/18	0.91
(13)	9677282009	100 ±10%	86 - 470	40/18	0.69
(14)	9677282509	95 ±10%	81 - 520	55/18	0.99
(15)	9677352509	124 ±10%	106 - 580	55/16	1.27
(16)	9677353509	110 ±10%	94 - 700	70/16	1.97
(17)	9677453509	142 ±10%	121 - 750	100/16	2.34

Quick Link: www.fair-rite.com/tor

A ring configuration provides the ultimate utilization of the intrinsic ferrite material properties. Toroidal cores are used in a wide variety of applications such as power input filters, ground-fault interrupters, common-mode filters and in pulse and broadband transformers.

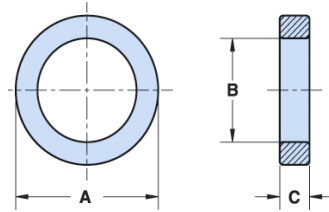

- Toroids are listed by initial permeability classes and increasing dimension of the inside diameter.
- All toroidal cores are supplied burnished to break sharp edges.
- Toroids are tested for A_L values at 10 kHz.
- Toroids with an outside diameter of 9.5 mm (0.375") or smaller can be supplied Parylene C coated. The Parylene coating will increase the "A" and "C" dimensions and decrease the "B" dimension a maximum of 0.038 mm (0.0015"). The ninth digit of a Parylene coated toroid part number is a "1". See reference tables for the material characteristics of Parylene C. Parylene C coating is RoHS compliant.
- Toroids with an outside diameter of 9.5 mm (0.375") or larger can be supplied with a uniform coating of thermo-set plastic coating. This coating will increase the "A" and "C" dimensions and decrease the "B" dimension a maximum of 0.5 mm (0.020"). The 9th digit of the thermo-set plastic coated toroid part number is a "2". Thermo-set plastic coating is RoHS compliant.
- Thermo-set plastic coated parts can withstand a minimum breakdown voltage of 1000 Vrms, uniformly applied across the "C" dimension of the toroid.
- The "C" dimension may be modified to suit specific applications.
- For any toroidal core requirement not listed in the catalog, please contact our customer service department for availability and pricing.
- Explanation of Part Numbers: Digits 1&2 = product class, 3&4 = material grade, 9th digit 1 = Parylene coating, 2 = thermo-set plastic coating.

Legend: Symbols & Definition

Dimensions (Top numbers are in millimeters, bottom numbers are in nominal inches.)

$\Sigma \ell/A$: Core Constant, ℓ_e : Effective Path Length, A_e : Effective Cross-Sectional Area, V_e : Effective Core Volume, A_L : Inductance Factor ($\frac{L}{N^2}$)

Low Permeability, 68 ($\mu_i=16$) material

Part Number	A	B	C	Wt. (g)	$\Sigma \ell A (\text{cm}^{-1})$	$\ell_e (\text{cm})$	$A_e (\text{cm}^2)$	$V_e (\text{cm}^3)$	$A_L (\text{nH})$
5968020901	6.10 -0.25 0.235	3.12 ±0.10 0.123	1.65 -0.25 0.060	0.19	63.68	1.33	0.021	0.027	2.3 Min
5968000201	9.50 ±0.20 0.740	4.75 ±0.15 0.187	3.30 -0.25 0.125	0.83	28.60	2.07	0.073	0.15	5.3 Min
5968000301	12.70 ±0.25 0.500	7.15 ±0.20 0.281	4.90 -0.25 0.188	2.00	22.90	2.95	0.129	0.38	6.6 Min
5968001101	12.70 ±0.25 0.500	7.90 ±0.20 0.311	6.35 ±0.25 0.250	2.40	20.80	3.12	0.15	0.47	7.2 Min
5968001801	22.10 ±0.40 0.870	13.70 ±0.30 0.539	6.35 ±0.25 0.250	7.20	20.70	5.41	0.262	1.42	7.3 Min
5968021001	29.95 ±0.65 1.179	19.45 ±0.50 0.766	7.50 ±0.25 0.295	21.80	19.39	7.52	0.388	2.917	7.7 Min

Fair-Rite Products Corp. PO Box 288, One Commercial Row, Wallkill, NY 12589-0288

Quick Link: www.fair-rite.com/tor

Low Permeability, 68 ($\mu_i=16$) material

Part Number	A	B	C	Wt. (g)	$\sum l/A(\text{cm}^{-1})$	$l_e(\text{cm})$	$A_e(\text{cm}^2)$	$V_e(\text{cm}^3)$	$A_L(\text{nH})$
5968002701	35.55 ±0.75 1.400	23.00 ±0.55 0.906	12.70 ±0.50 0.500	33.00	11.20	8.90	0.78	7.00	13 Min
5968003801	61.00 ±1.30 2.402	35.55 ±0.85 1.400	12.70 ±0.50 0.500	106.00	9.20	14.50	1.58	22.80	16 Min

Low Permeability, 67 ($\mu_i=40$) material

Part Number	A	B	C	Wt. (g)	$\sum l/A(\text{cm}^{-1})$	$l_e(\text{cm})$	$A_e(\text{cm}^2)$	$V_e(\text{cm}^3)$	$A_L(\text{nH})$
5967000101	5.95 -0.25 0.230	3.05 ±0.10 0.120	1.65 -0.25 0.060	0.14	63.80	1.30	0.02	0.027	6 Min
5967000201	9.50 ±0.20 0.375	4.75 ±0.15 0.187	3.30 -0.25 0.125	0.83	28.60	2.07	0.072	0.15	18 +35%, -25%
5967000301	12.70 ±0.25 0.500	7.15 ±0.20 0.281	4.90 -0.25 0.188	2.00	22.90	2.95	0.129	0.38	22 +35%, -25%
5967001101	12.70 ±0.25 0.500	7.90 ±0.20 0.312	6.35 ±0.25 0.250	2.40	20.80	3.12	0.15	0.47	24 +35%, -25%
5967001901	12.70 ±0.25 0.500	7.90 ±0.20 0.312	12.70 ±0.35 0.500	4.70	10.40	3.12	0.299	0.93	48 +35%, -25%
5967000601	21.00 ±0.35 0.825	13.20 ±0.30 0.520	6.35 ±0.25 0.250	6.40	21.30	5.20	0.243	1.26	24 +35%, -25%
5967001801	22.10 ±0.40 0.870	13.70 ±0.30 0.540	6.35 ±0.25 0.250	7.20	20.70	5.40	0.262	1.42	24 +35%, -25%
5967001001	29.00 ±0.65 1.142	19.00 ±0.50 0.748	7.50 ±0.25 0.295	13.00	19.80	7.30	0.37	2.70	25 +35%, -25%
5967001201	29.00 ±0.65 1.142	19.00 ±0.50 0.748	13.85 ±0.30 0.545	26.00	10.70	7.30	0.68	5.00	47 +35%, -25%
5967001701	31.75 ±0.75 1.250	19.05 ±0.50 0.750	9.50 ±0.30 0.375	23.00	12.90	7.60	0.59	4.50	39 +35%, -25%
5967002701	35.55 ±0.75 1.400	23.00 ±0.55 0.900	12.70 ±0.50 0.500	33.00	11.20	8.90	0.79	7.00	45 +35%, -25%
5967003821	62.80 Max 2.472 Max	34.20 Min 1.346 Min	13.70 Max 0.539 Max	106.00	9.20	14.50	1.58	22.80	55 +35%, -25%
5967003801	61.00 ±1.30 2.400	35.55 ±0.85 1.400	12.70 ±0.50 0.500	106.00	9.20	14.50	1.58	22.80	55 +35%, -25%

Low Permeability, 61 ($\mu_i=125$) material

Part Number	A	B	C	Wt. (g)	$\sum l/A(\text{cm}^{-1})$	$l_e(\text{cm})$	$A_e(\text{cm}^2)$	$V_e(\text{cm}^3)$	$A_L(\text{nH})$
5961000801	3.95 ±0.15 0.155	2.15 +0.15 0.088	1.40 -0.25 0.050	0.05	87.60	0.92	0.011	0.0097	15 Min
5961000811	4.14 Max 0.162 Max	2.11 Min 0.084 Min	1.44 Max 0.056 Max	0.05	87.60	0.92	0.011	0.0097	15 Min
5961000101	5.95 -0.25 0.230	3.05 ±0.10 0.120	1.65 -0.25 0.060	0.14	63.80	1.30	0.02	0.027	25 ±25%
5961000111	5.99 Max 0.235 Max	2.91 Min 0.115 Min	1.69 Max 0.066 Max	0.14	63.80	1.30	0.02	0.027	25 ±25%
5961000201	9.50 ±0.20 0.375	4.75 ±0.15 0.187	3.30 -0.25 0.125	0.83	28.60	2.07	0.072	0.15	55 ±25%
5961000211	9.74 Max 0.383 Max	4.56 Min 0.180 Min	3.34 Max 0.132 Max	0.83	28.60	2.07	0.072	0.15	55 ±25%
5961000221	10.20 Max 0.401 Max	4.10 Min 0.162 Min	3.80 Max 0.149 Max	0.83	28.60	2.07	0.072	0.15	55 ±25%
5961000301	12.70 ±0.25 0.500	7.15 ±0.20 0.281	4.90 -0.25 0.188	2.00	22.90	2.95	0.129	0.38	69 ±25%

Fair-Rite Products Corp. PO Box 288, One Commercial Row, Wallkill, NY 12589-0288

Phone: (888) FAIR RITE / (845) 895-2055 • Fax: (888) FERRITE / (845) 895-2629 • Web: www.fair-rite.com
 (888) 324-7748 (888) 337-7483 E -mail: ferrites@fair-rite.com

Low Permeability, 61 ($\mu_i=125$) material

Part Number	A	B	C	Wt. (g)	$\sum lA(\text{cm}^2)$	$l_e(\text{cm})$	$A_e(\text{cm}^2)$	$V_e(\text{cm}^3)$	$A_L(\text{nH})$
5961000321	13.45 Max 0.529 Max	6.45 Min 0.254 Min	5.40 Max 0.212 Max	2.00	22.90	2.95	0.129	0.38	69 ±25%
5961001101	12.70 ±0.25 0.500	7.90 ±0.20 0.312	6.35 ±0.25 0.250	2.40	20.80	3.12	0.15	0.47	75 ±25%
5961001121	13.45 Max 0.529 Max	7.20 Min 0.283 Min	7.10 Max 0.280 Max	2.40	20.80	3.12	0.15	0.47	75 ±25%
5961001901	12.70 ±0.25 0.500	7.90 ±0.20 0.312	12.70 ±0.35 0.500	4.70	10.40	3.12	0.299	0.93	150 ±25%
5961001921	13.45 Max 0.529 Max	7.20 Min 0.283 Min	13.55 Max 0.533 Max	4.70	10.40	3.12	0.299	0.93	150 ±25%
5961004901	16.00 ±0.40 0.630	9.60 ±0.30 0.378	6.35 ±0.25 0.250	4.00	19.40	3.85	0.199	0.77	80 ±25%
5961004921	16.90 Max 0.665 Max	8.80 Min 0.347 Min	7.10 Max 0.280 Max	4.00	19.40	3.85	0.199	0.77	80 ±25%
5961000601	21.00 ±0.35 0.825	13.20 ±0.30 0.520	6.35 ±0.25 0.250	6.40	21.30	5.20	0.243	1.26	75 ±25%
5961000621	21.85 Max 0.860 Max	12.40 Min 0.489 Min	7.10 Max 0.280 Max	6.40	21.30	5.20	0.243	1.26	75 ±25%
5961000501	21.00 ±0.35 0.825	13.20 ±0.30 0.520	11.90 ±0.40 0.468	12.00	11.40	5.20	0.46	2.36	135 ±25%
5961001801	22.10 ±0.40 0.870	13.70 ±0.30 0.540	6.35 ±0.25 0.250	7.20	20.70	5.40	0.262	1.42	75 ±25%
5961001821	23.00 Max 0.905 Max	12.90 Min 0.508 Min	7.10 Max 0.280 Max	7.20	20.70	5.40	0.262	1.42	75 ±25%
5961001001	29.00 ±0.65 1.142	19.00 ±0.50 0.748	7.50 ±0.25 0.295	13.00	19.80	7.30	0.37	2.70	80 ±25%
5961001021	30.15 Max 1.187 Max	18.00 Min 0.708 Min	8.25 Max 0.325 Max	13.00	19.80	7.30	0.37	2.70	80 ±25%
5961001201	29.00 ±0.65 1.142	19.00 ±0.50 0.748	13.85 ±0.30 0.545	26.00	10.70	7.30	0.68	5.00	145 ±25%
5961001221	30.15 Max 1.187 Max	18.00 Min 0.708 Min	14.65 Max 0.576 Max	26.00	10.70	7.30	0.68	5.00	145 ±25%
5961001701	31.75 ±0.75 1.250	19.05 ±0.50 0.750	9.50 ±0.30 0.375	23.00	12.90	7.60	0.59	4.50	120 ±25%
5961001721	33.00 Max 1.299 Max	18.05 Min 0.729 Min	10.30 Max 0.405 Max	23.00	12.90	7.60	0.59	4.50	120 ±25%
5961002701	35.55 ±0.75 1.400	23.00 ±0.55 0.900	12.70 ±0.50 0.500	33.00	11.20	8.90	0.79	7.00	140 ±25%
5961002721	36.80 Max 1.449 Max	21.95 Min 0.864 Min	13.70 Max 0.539 Max	33.00	11.20	8.90	0.79	7.00	140 ±25%
5961003801	61.00 ±1.30 2.400	35.55 ±0.85 1.400	12.70 ±0.50 0.500	106.00	9.20	14.50	1.58	22.80	170 ±25%
5961003821	62.80 Max 2.472 Max	34.20 Min 1.346 Min	13.70 Max 0.539 Max	106.00	9.20	14.50	1.58	22.80	170 ±25%

Low-Medium Permeability, 52 ($\mu_i=250$) material

Part Number	A	B	C	Wt. (g)	$\sum lA(\text{cm}^2)$	$l_e(\text{cm})$	$A_e(\text{cm}^2)$	$V_e(\text{cm}^3)$	$A_L(\text{nH})$
5952020201	5.84 -0.26 0.225	3.00 ±0.10 0.118	1.65 -0.25 0.060	0.15	63.88	1.28	0.02	0.0256	49 ±25%
5952020301	9.42 ±0.20 0.371	4.72 ±0.15 0.186	3.30 -0.25 0.125	0.87	28.66	2.06	0.072	0.147	110 ±25%
5952020401	12.60 ±0.25 0.496	6.99 ±0.20 0.275	4.90 -0.25 0.188	2.16	22.31	2.90	0.13	0.378	141 ±25%
5952020501	12.45 ±0.25 0.490	7.80 ±0.20 0.307	6.35 ±0.25 0.250	2.46	21.24	3.06	0.144	0.442	148 ±25%

Quick Link: www.fair-rite.com/tor

Low-Medium Permeability, 52 ($\mu_i=250$) material

Part Number	A	B	C	Wt. (g)	$\sum l/A(\text{cm}^{-1})$	$l_e(\text{cm})$	$A_e(\text{cm}^2)$	$V_e(\text{cm}^3)$	$A_L(\text{nH})$
5952020601	21.70 \pm 0.40 0.854	13.50 \pm 0.30 0.531	6.35 \pm 0.25 0.250	7.54	20.80	5.33	0.256	1.368	151 \pm 25%
5952020701	28.80 \pm 0.65 1.134	18.70 \pm 0.50 0.736	7.50 \pm 0.25 0.250	14.81	19.34	7.23	0.374	2.702	162 \pm 25%
5952020801	35.25 \pm 0.75 1.388	22.60 \pm 0.55 0.890	12.70 \pm 0.50 0.500	38.26	11.10	8.79	0.792	6.959	283 \pm 25%
5952003801	60.00 \pm 1.30 2.362	35.35 \pm 0.60 1.392	12.70 \pm 0.50 0.500	133.44	9.14	14.50	1.58	22.80	325 \pm 25%

Low-Medium Permeability, 43 ($\mu_i=800$) material

Part Number	A	B	C	Wt. (g)	$\sum l/A(\text{cm}^{-1})$	$l_e(\text{cm})$	$A_e(\text{cm}^2)$	$V_e(\text{cm}^3)$	$A_L(\text{nH})$
5943000801	3.95 \pm 0.15 0.155	2.15 \pm 0.15 0.088	1.40 -0.25 0.050	0.05	87.60	0.92	0.011	0.0097	117 \pm 20%
5943000101	5.95 -0.25 0.230	3.05 \pm 0.10 0.120	1.65 -0.25 0.060	0.14	63.80	1.30	0.02	0.027	158 \pm 20%
5943000111	5.99 Max 0.235 Max	2.91 Min 0.115 Min	1.69 Max 0.066 Max	0.14	63.80	1.30	0.02	0.027	158 \pm 20%
5943000901	5.95 -0.25 0.230	3.05 \pm 0.10 0.120	3.05 \pm 0.10 0.120	0.29	31.80	1.30	0.041	0.053	315 \pm 20%
5943000911	5.99 Max 0.235 Max	2.91 Min 0.115 Min	3.19 Max 0.126 Max	0.29	31.80	1.30	0.041	0.053	315 \pm 20%
5943000201	9.50 \pm 0.20 0.375	4.75 \pm 0.15 0.187	3.30 -0.25 0.125	0.83	28.60	2.07	0.072	0.15	350 \pm 20%
5943000211	9.74 Max 0.383 Max	4.56 Min 0.180 Min	3.34 Max 0.132 Max	0.83	28.60	2.07	0.072	0.15	350 \pm 20%
5943000221	10.20 Max 0.401 Max	4.10 Min 0.162 Min	3.80 Max 0.149 Max	0.83	28.60	2.07	0.072	0.15	350 +20%, -25%
5943000301	12.70 \pm 0.25 0.500	7.15 \pm 0.20 0.281	4.90 -0.25 0.188	2.00	22.90	2.95	0.129	0.38	440 \pm 20%
5943000321	13.45 Max 0.529 Max	6.45 Min 0.254 Min	5.40 Max 0.213 Max	2.00	22.90	2.95	0.129	0.38	440 +20%, -25%
5943001101	12.70 \pm 0.25 0.500	7.90 \pm 0.20 0.312	6.35 \pm 0.25 0.250	2.40	20.80	3.12	0.15	0.47	480 \pm 20%
5943001121	13.45 Max 0.529 Max	7.20 Min 0.283 Min	7.10 Max 0.280 Max	2.40	20.80	3.12	0.15	0.47	480 +20%, -25%
5943001901	12.70 \pm 0.25 0.500	7.90 \pm 0.20 0.312	12.70 \pm 0.35 0.500	4.70	10.40	3.12	0.299	0.93	965 \pm 20%
5943001921	13.45 Max 0.529 Max	7.20 Min 0.283 Min	13.55 Max 0.533 Max	4.70	10.40	3.12	0.299	0.93	965 +20%, -25%
5943005101	16.00 \pm 0.40 0.630	9.60 \pm 0.30 0.378	4.75 -0.25 0.182	2.80	26.60	3.85	0.145	0.56	375 \pm 20%
5943004901	16.00 \pm 0.40 0.630	9.60 \pm 0.30 0.378	6.35 \pm 0.25 0.250	4.00	19.40	3.85	0.199	0.77	520 \pm 20%
5943004921	16.90 Max 0.665 Max	8.80 Min 0.347 Min	7.10 Max 0.280 Max	4.00	19.40	3.85	0.199	0.77	520 +20%, -25%
5943000601	21.00 \pm 0.35 0.825	13.20 \pm 0.30 0.520	6.35 \pm 0.25 0.250	6.40	21.30	5.20	0.243	1.26	470 \pm 20%
5943000621	21.85 Max 0.860 Max	12.40 Min 0.489 Min	7.10 Max 0.280 Max	6.40	21.30	5.20	0.243	1.26	470 +20%, -25%
5943000501	21.00 \pm 0.35 0.825	13.20 \pm 0.30 0.520	11.90 \pm 0.40 0.468	12.00	11.40	5.20	0.46	2.36	885 \pm 20%
5943000521	21.85 Max 0.860 Max	12.40 Min 0.489 Min	12.80 Max 0.503 Max	12.00	11.40	5.20	0.46	2.36	885 +20%, -25%
5943001801	22.10 \pm 0.40 0.870	13.70 \pm 0.30 0.540	6.35 \pm 0.25 0.250	7.20	20.70	5.40	0.262	1.42	485 \pm 20%

Low-Medium Permeability, 43 ($\mu_i=800$) material

Part Number	A	B	C	Wt. (g)	$\sum lA(\text{cm}^2)$	$l_e(\text{cm})$	$A_e(\text{cm}^2)$	$V_e(\text{cm}^3)$	$A_L(\text{nH})$
5943001821	23.00 Max 0.905 Max	12.90 Min 0.508 Min	7.10 Max 0.279 Max	7.20	20.70	5.40	0.262	1.42	485 +20%, -25%
5943007601	22.10 \pm 0.40 0.870	13.70 \pm 0.30 0.540	12.70 \pm 0.45 0.500	15.00	10.30	5.40	0.52	2.83	970 \pm 20%
5943001301	25.40 \pm 0.60 1.000	15.50 \pm 0.50 0.610	6.35 \pm 0.25 0.250	9.60	20.00	6.20	0.308	1.90	500 \pm 20%
5943001401	25.40 \pm 0.60 1.000	15.50 \pm 0.50 0.610	8.15 \pm 0.30 0.320	12.00	15.10	6.20	0.41	2.52	645 \pm 20%
5943001421	26.50 Max 1.043 Max	14.50 Min 0.571 Min	8.95 Max 0.352 Max	12.00	15.10	6.20	0.41	2.52	645 +20%, -25%
5943006401	25.40 \pm 0.60 1.000	15.50 \pm 0.50 0.610	12.70 \pm 0.50 0.500	19.00	10.00	6.20	0.62	3.80	1000 \pm 20%
5943006421	26.50 Max 1.043 Max	14.50 Min 0.571 Min	13.70 Max 0.539 Max	19.00	10.00	6.20	0.62	3.80	1000 +20%, -25%
5943001001	29.00 \pm 0.65 1.142	19.00 \pm 0.50 0.748	7.50 \pm 0.25 0.295	13.00	19.80	7.30	0.37	2.70	510 \pm 20%
5943001021	30.15 Max 1.187 Max	18.00 Min 0.708 Min	8.25 Max 0.325 Max	13.00	19.80	7.30	0.37	2.70	510 +20%, -25%
5943001201	29.00 \pm 0.65 1.142	19.00 \pm 0.50 0.748	13.85 \pm 0.30 0.545	26.00	10.70	7.30	0.68	5.00	950 \pm 20%
5943001601	31.10 \pm 0.75 1.225	19.05 \pm 0.50 0.750	7.90 \pm 0.30 0.312	18.00	16.20	7.60	0.47	3.53	620 \pm 20%
5943001701	31.75 \pm 0.75 1.250	19.05 \pm 0.50 0.750	9.50 \pm 0.30 0.375	23.00	12.90	7.60	0.59	4.50	775 \pm 20%
5943002701	35.55 \pm 0.75 1.400	23.00 \pm 0.55 0.900	12.70 \pm 0.50 0.500	33.00	11.20	8.90	0.79	7.00	885 \pm 20%
5943002721	36.80 Max 1.449 Max	21.95 Min 0.864 Min	13.70 Max 0.539 Max	33.00	11.20	8.90	0.79	7.00	885 +20%, -25%
5943018601	43.60 \pm 1.00 1.717	23.10 \pm 0.50 0.909	18.00 \pm 0.50 0.709	90.00	5.50	9.80	1.78	17.50	1850 \pm 25%
5943017301	48.30 \pm 1.00 1.902	31.80 \pm 0.60 1.252	19.05 \pm 0.35 0.750	94.00	7.90	12.20	1.55	18.90	1275 \pm 25%
5943003801	61.00 \pm 1.30 2.400	35.55 \pm 0.85 1.400	12.70 \pm 0.50 0.500	106.00	9.20	14.50	1.58	22.80	1075 \pm 20%
5943003821	62.80 Max 2.472 Max	34.20 Min 1.347 Min	13.70 Max 0.539 Max	106.00	9.20	14.50	1.58	22.80	1075 +20%, -25%
5943011101	73.65 \pm 1.50 2.900	38.85 \pm 0.75 1.530	12.70 \pm 0.40 0.500	188.00	7.80	16.70	2.15	35.90	1300 \pm 25%
5943011121	75.85 Max 2.978 Max	37.60 Min 1.480 Min	13.60 Max 0.535 Max	188.00	7.80	16.70	2.15	35.90	1300 +25%, -30%
5943015901	100.00 \pm 2.00 3.937	55.00 \pm 1.20 2.165	12.70 \pm 0.30 0.500	320.00	8.30	23.00	2.77	63.70	1215 \pm 25%
5943017501	102.60 \pm 2.10 4.039	63.50 \pm 1.30 2.500	15.85 \pm 0.35 0.624	360.00	8.30	25.10	3.00	70.50	1225 \pm 25%

Medium Permeability, 77 ($\mu_i=2000$) & 78 ($\mu_i=2300$) materials

Part Number	A	B	C	Wt. (g)	$\sum lA(\text{cm}^2)$	$l_e(\text{cm})$	$A_e(\text{cm}^2)$	$V_e(\text{cm}^3)$	$A_L(\text{nH})$
5978002101	4.95 -0.25 0.190	2.20 +0.15 0.090	1.40 -0.25 0.050	0.09	69.20	1.04	0.015	0.0157	440 \pm 25%
5977000101	5.95 -0.25 0.230	3.05 \pm 0.10 0.120	1.65 -0.25 0.060	0.14	63.80	1.30	0.02	0.027	420 \pm 25%
5977000201	9.50 \pm 0.20 0.375	4.75 \pm 0.15 0.187	3.30 -0.25 0.125	0.83	28.60	2.07	0.072	0.15	945 \pm 25%
5977000211	9.74 Max 0.383 Max	4.56 Min 0.180 Min	3.34 Max 0.131 Max	0.83	28.60	2.07	0.072	0.15	945 \pm 25%

Quick Link: www.fair-rite.com/tor

Medium Permeability, 77 ($\mu_i=2000$) & 78 ($\mu_i=2300$) materials

Part Number	A	B	C	Wt. (g)	$\sum l/A(\text{cm}^{-1})$	$l_e(\text{cm})$	$A_e(\text{cm}^2)$	$V_e(\text{cm}^3)$	$A_L(\text{nH})$
5977000221	10.20 Max 0.401 Max	4.10 Min 0.162 Min	3.80 Max 0.149 Max	0.83	28.60	2.07	0.072	0.15	945 +25%, -30%
5977000301	12.70 \pm 0.25 0.500	7.15 \pm 0.20 0.281	4.90 -0.25 0.188	2.00	22.90	2.95	0.129	0.38	1180 \pm 25%
5977000321	13.45 Max 0.529 Max	6.45 Min 0.254 Min	5.40 Max 0.212 Max	2.00	22.90	2.95	0.129	0.38	1180 +25%, -30%
5977001101	12.70 \pm 0.25 0.500	7.90 \pm 0.20 0.312	6.35 \pm 0.25 0.250	2.40	20.80	3.12	0.15	0.47	1300 \pm 25%
5977001121	13.45 Max 0.529 Max	7.20 Min 0.284 Min	7.10 Max 0.279 Max	2.40	20.80	3.12	0.15	0.47	1300 +25%, -30%
5977001901	12.70 \pm 0.25 0.500	7.90 \pm 0.20 0.312	12.70 \pm 0.35 0.500	4.70	10.40	3.12	0.299	0.93	2595 \pm 25%
5977001921	13.45 Max 0.529 Max	7.20 Min 0.284 Min	13.55 Max 0.533 Max	4.70	10.40	3.12	0.299	0.93	2595 +25%, -30%
5977005101	16.00 \pm 0.40 0.630	9.60 \pm 0.30 0.378	4.75 -0.25 0.182	2.80	26.60	3.85	0.145	0.56	1015 \pm 25%
5977004901	16.00 \pm 0.40 0.630	9.60 \pm 0.30 0.378	6.35 \pm 0.25 0.250	4.00	19.40	3.85	0.199	0.77	1400 \pm 25%
5977000601	21.00 \pm 0.35 0.825	13.20 \pm 0.30 0.520	6.35 \pm 0.25 0.250	6.40	21.30	5.20	0.243	1.26	1270 \pm 25%
5977000621	21.85 Max 0.860 Max	12.40 Min 0.489 Min	7.10 Max 0.279 Max	6.40	21.30	5.20	0.243	1.26	1270 +25%, -30%
5977000501	21.00 \pm 0.35 0.825	13.20 \pm 0.30 0.520	11.90 \pm 0.40 0.468	12.00	11.40	5.20	0.46	2.36	2375 \pm 25%
5977001801	22.10 \pm 0.40 0.870	13.70 \pm 0.30 0.540	6.35 \pm 0.25 0.250	7.20	20.70	5.40	0.262	1.42	1305 \pm 25%
5977001821	23.00 Max 0.905 Max	12.90 Min 0.508 Min	7.10 Max 0.279 Max	7.20	20.70	5.40	0.262	1.42	1305 +25%, -30%
5977007601	22.10 \pm 0.40 0.870	13.70 \pm 0.30 0.540	12.70 \pm 0.45 0.500	15.00	10.30	5.40	0.52	2.83	2615 \pm 25%
5978007601	22.10 \pm 0.40 0.870	13.70 \pm 0.30 0.540	12.70 \pm 0.45 0.500	15.00	10.30	5.40	0.52	2.83	2795 \pm 25%
5978007621	23.00 Max 0.905 Max	12.90 Min 0.508 Min	13.65 Max 0.537 Max	15.00	10.30	5.40	0.52	2.83	2795 +25%, -30%
5977001301	25.40 \pm 0.60 1.000	15.50 \pm 0.50 0.610	6.35 \pm 0.25 0.250	9.60	20.00	6.20	0.308	1.90	1350 \pm 25%
5977001321	26.50 Max 1.043 Max	14.50 Min 0.571 Min	7.10 Max 0.279 Max	9.60	20.00	6.20	0.308	1.90	1350 +25%, -30%
5977001401	25.40 \pm 0.60 1.000	15.50 \pm 0.50 0.610	8.15 \pm 0.30 0.320	12.00	15.10	6.20	0.41	2.52	1730 \pm 25%
5977001421	26.50 Max 1.043 Max	14.50 Min 0.571 Min	8.95 Max 0.352 Max	12.00	15.10	6.20	0.41	2.52	1730 +25%, -30%
5977006401	25.40 \pm 0.60 1.000	15.50 \pm 0.50 0.610	12.70 \pm 0.50 0.500	19.00	10.00	6.20	0.62	3.80	2700 \pm 25%
5977001001	29.00 \pm 0.65 1.142	19.00 \pm 0.50 0.748	7.50 \pm 0.25 0.295	13.00	19.80	7.30	0.37	2.70	1365 \pm 25%
5977001021	30.15 Max 1.187 Max	18.00 Min 0.709 Min	8.25 Max 0.324 Max	13.00	19.80	7.30	0.37	2.70	1365 +25%, -30%
5977001201	29.00 \pm 0.65 1.142	19.00 \pm 0.50 0.748	13.85 \pm 0.30 0.545	26.00	10.70	7.30	0.68	5.00	2520 \pm 25%
5977001221	30.15 Max 1.187 Max	18.00 Min 0.709 Min	14.65 Max 0.576 Max	26.00	10.70	7.30	0.68	5.00	2520 +25%, -30%
5978001201	29.00 \pm 0.65 1.142	19.00 \pm 0.50 0.748	13.85 \pm 0.30 0.545	26.00	10.70	7.30	0.68	5.00	2695 \pm 25%
5978001221	30.15 Max 1.187 Max	18.00 Min 0.709 Min	14.65 Max 0.576 Max	26.00	10.70	7.30	0.68	5.00	2695 +25%, -30%
5977001601	31.10 \pm 0.75 1.225	19.05 \pm 0.50 0.750	7.90 \pm 0.30 0.312	18.00	16.20	7.60	0.47	3.53	1665 \pm 25%
5977001621	32.25 Max 1.273 Max	18.05 Min 0.711 Min	8.70 Max 0.342 Max	18.00	16.20	7.60	0.47	3.53	1665 +25%, -30%
5977001701	31.75 \pm 0.75 1.250	19.05 \pm 0.50 0.750	9.50 \pm 0.30 0.375	23.00	12.90	7.60	0.59	4.50	2090 \pm 25%

Fair-Rite Products Corp. PO Box 288, One Commercial Row, Wallkill, NY 12589-0288

Phone: (888) FAIR RITE / (845) 895-2055 • Fax: (888) FERRITE / (845) 895-2629 • Web: www.fair-rite.com
 (888) 324-7748 (888) 337-7483 E-mail: ferrites@fair-rite.com

Medium Permeability, 77 ($\mu_i=2000$) & 78 ($\mu_i=2300$) materials

Part Number	A	B	C	Wt. (g)	$\sum lA(\text{cm}^2)$	$l_e(\text{cm})$	$A_e(\text{cm}^2)$	$V_e(\text{cm}^3)$	$A_L(\text{nH})$
5977001721	33.00 Max 1.299 Max	18.05 Min 0.711 Min	10.30 Max 0.405 Max	23.00	12.90	7.60	0.59	4.50	2090 +25%, -30%
5978001701	31.75 \pm 0.75 1.250	19.05 \pm 0.50 0.750	9.50 \pm 0.30 0.375	23.00	12.90	7.60	0.59	4.50	2230 \pm 25%
5978001721	33.00 Max 1.299 Max	18.05 Min 0.711 Min	10.30 Max 0.405 Max	23.00	12.90	7.60	0.59	4.50	2230 +25%, -30%
5977002701	35.55 \pm 0.75 1.400	23.00 \pm 0.55 0.900	12.70 \pm 0.50 0.500	33.00	11.20	8.90	0.79	7.00	2400 \pm 25%
5977002721	36.80 Max 1.448 Max	21.95 Min 0.865 Min	13.70 Max 0.539 Max	33.00	11.20	8.90	0.79	7.00	2400 +25%, -30%
5978002701	35.55 \pm 0.75 1.400	23.00 \pm 0.55 0.900	12.70 \pm 0.50 0.500	33.00	11.20	8.90	0.79	7.00	2545 \pm 25%
5978002721	36.80 Max 1.448 Max	21.95 Min 0.865 Min	13.70 Max 0.539 Max	33.00	11.20	8.90	0.79	7.00	2545 +25%, -30%
5978018601	43.60 \pm 1.00 1.717	23.10 \pm 0.50 0.909	18.00 \pm 0.50 0.709	90.00	5.50	9.80	1.78	17.50	5260 \pm 25%
5978017301	48.30 \pm 1.00 1.902	31.80 \pm 0.60 1.252	19.05 \pm 0.35 0.750	94.00	7.90	12.20	1.55	18.90	3670 \pm 25%
5978017321	49.80 Max 1.960 Max	30.70 Min 1.209 Min	19.90 Max 0.783 Max	94.00	7.90	12.20	1.55	18.90	3670 +25%, -30%
5978018701	56.30 \pm 1.20 2.217	32.70 \pm 0.70 1.287	18.00 \pm 0.50 0.709	135.00	6.40	13.30	2.07	27.60	4500 \pm 25%
5978018721	58.00 Max 2.283 Max	31.50 Min 1.240 Min	19.00 Max 0.748 Max	135.00	6.40	13.30	2.07	27.60	4500 +25%, -30%
5977003801	61.00 \pm 1.30 2.400	35.55 \pm 0.85 1.400	12.70 \pm 0.50 0.500	106.00	9.20	14.50	1.58	22.80	2950 \pm 25%
5977003821	62.80 Max 2.472 Max	34.20 Min 1.347 Min	13.70 Max 0.539 Max	106.00	9.20	14.50	1.58	22.80	2950 +25%, -30%
5978003801	61.00 \pm 1.30 2.400	35.55 \pm 0.85 1.400	12.70 \pm 0.50 0.500	106.00	9.20	14.50	1.58	22.80	3155 \pm 25%
5978003821	62.80 Max 2.472 Max	34.20 Min 1.347 Min	13.70 Max 0.539 Max	106.00	9.20	14.50	1.58	22.80	3155 +25%, -30%
5977011101	73.65 \pm 1.50 2.900	38.85 \pm 0.75 1.530	12.70 \pm 0.40 0.500	188.00	7.80	16.70	2.15	35.90	3500 \pm 25%
5977011121	75.65 Max 2.978 Max	37.60 Min 1.480 Min	13.60 Max 0.535 Max	188.00	7.80	16.70	2.15	35.90	3500 +25%, -30%
5978011101	73.65 \pm 1.50 2.900	38.85 \pm 0.75 1.530	12.70 \pm 0.40 0.500	188.00	7.80	16.70	2.15	35.90	3740 \pm 25%
5978015901	100.00 \pm 2.00 3.937	55.00 \pm 1.20 2.165	12.70 \pm 0.30 0.500	320.00	8.30	23.00	2.77	63.70	3500 \pm 25%
5978008001	154.20 \pm 3.81 6.070	69.40 \pm 1.73 2.732	19.05 \pm 0.50 0.750	1240.00	4.10	31.30	7.60	237.00	7000 \pm 25%
5978014001	101.60 \pm 2.10 4.000	75.20 \pm 1.50 2.961	24.75 \pm 0.55 0.974	425.00	8.40	27.40	3.24	88.70	3425 \pm 25%

High Permeability, 75 ($\mu_i=5000$) material

Part Number	A	B	C	Wt. (g)	$\sum lA(\text{cm}^2)$	$l_e(\text{cm})$	$A_e(\text{cm}^2)$	$V_e(\text{cm}^3)$	$A_L(\text{nH})$
5975000801	3.95 \pm 0.15 0.155	2.15 \pm 0.15 0.088	1.40 -0.25 0.050	0.05	87.60	0.92	0.011	0.0097	585 \pm 20%
5975002101	4.95 -0.25 0.190	2.20 \pm 0.15 0.090	1.40 -0.25 0.050	0.09	69.20	1.04	0.015	0.0157	770 \pm 20%
5975000101	5.95 -0.25 0.230	3.05 \pm 0.10 0.120	1.65 -0.25 0.060	0.14	63.80	1.30	0.02	0.027	785 \pm 20%
5975000201	9.50 \pm 0.20 0.375	4.75 \pm 0.15 0.187	3.30 -0.25 0.125	0.83	28.60	2.07	0.072	0.15	2200 \pm 20%

High Permeability, 75 ($\mu_i=5000$) material

Part Number	A	B	C	Wt. (g)	$\sum l/A(\text{cm}^{-1})$	$l_e(\text{cm})$	$A_e(\text{cm}^2)$	$V_e(\text{cm}^3)$	$A_L(\text{nH})$
5975000211	9.74 Max 0.383 Max	4.56 Min 0.180 Min	3.34 Max 0.132 Max	0.83	28.60	2.07	0.072	0.15	2200 ±20%
5975000221	10.20 Max 0.401 Max	4.10 Min 0.162 Min	3.80 Max 0.149 Max	0.83	28.60	2.07	0.072	0.15	2200 +20%, -25%
5975000301	12.70 ±0.25 0.500	7.15 ±0.20 0.281	4.90 -0.25 0.188	2.00	22.90	2.95	0.129	0.38	2725 ±20%
5975000321	13.45 Max 0.529 Max	6.45 Min 0.254 Min	5.40 Max 0.212 Max	2.00	22.90	2.95	0.129	0.38	2725 +20%, -25%
5975001101	12.70 ±0.25 0.500	7.90 ±0.20 0.312	6.35 ±0.25 0.250	2.40	20.80	3.12	0.15	0.47	3000 ±20%
5975001121	13.45 Max 0.529 Max	7.20 Min 0.284 Min	7.10 Max 0.280 Max	2.40	20.80	3.12	0.15	0.47	3000 +20%, -25%
5975001901	12.70 ±0.25 0.500	7.90 ±0.20 0.312	12.70 ±0.35 0.500	4.70	10.40	3.12	0.299	0.93	6000 ±20%
5975005101	16.00 ±0.40 0.630	9.60 ±0.30 0.378	4.75 -0.25 0.182	2.80	26.60	3.85	0.145	0.56	2350 ±20%
5975004901	16.00 ±0.40 0.630	9.60 ±0.30 0.378	6.35 ±0.25 0.250	4.00	19.40	3.85	0.199	0.77	3225 ±20%
5975004921	16.90 Max 0.665 Max	8.80 Min 0.347 Min	7.10 Max 0.280 Max	4.00	19.40	3.85	0.199	0.77	3225 +20%, -25%
5975000601	21.00 ±0.35 0.825	13.20 ±0.30 0.520	6.35 ±0.25 0.250	6.40	21.30	5.20	0.243	1.26	2950 ±20%
5975000621	21.85 Max 0.860 Max	12.40 Min 0.489 Min	7.10 Max 0.280 Max	6.40	21.30	5.20	0.243	1.26	2950 +20%, -25%
5975000501	21.00 ±0.35 0.825	13.20 ±0.30 0.520	11.90 ±0.40 0.468	12.00	11.40	5.20	0.46	2.36	5500 ±20%
5975001801	22.10 ±0.40 0.870	13.70 ±0.30 0.540	6.35 ±0.25 0.250	7.20	20.70	5.40	0.262	1.42	3025 ±20%
5975001821	23.00 Max 0.905 Max	12.90 Min 0.508 Min	7.10 Max 0.280 Max	7.20	20.70	5.40	0.262	1.42	3025 +20%, -25%
5975007601	22.10 ±0.40 0.870	13.70 ±0.30 0.540	12.70 ±0.45 0.500	15.00	10.30	5.40	0.52	2.83	6100 ±20%
5975007621	23.00 Max 0.905 Max	12.90 Min 0.508 Min	13.65 Max 0.537 Max	15.00	10.30	5.40	0.52	2.83	6100 +20%, -25%
5975001401	25.40 ±0.60 1.000	15.50 ±0.50 0.610	8.15 ±0.30 0.320	12.00	15.10	6.20	0.41	2.52	4000 ±20%
5975006401	25.40 ±0.60 1.000	15.50 ±0.50 0.610	12.70 ±0.50 0.500	19.00	10.00	6.20	0.62	3.80	6250 ±20%
5975002701	35.55 ±0.75 1.400	23.00 ±0.55 0.900	12.70 ±0.50 0.500	33.00	11.20	8.90	0.79	7.00	5500 ±25%
5975021921	50.40 Max 1.984 Max	32.50 Min 1.278 Min	16.85 Max 0.663 Max	76.00	10.59	12.70	1.20	15.30	6500 +25%, -30%
5975022021	50.40 Max 1.984 Max	32.50 Min 1.278 Min	20.00 Max 0.787 Max	91.00	8.86	12.70	1.44	18.27	7770 +25%, -30%
5975003801	61.00 ±1.30 2.400	35.55 ±0.85 1.400	12.70 ±0.50 0.500	106.00	9.20	14.50	1.58	22.80	6850 ±25%
5975003821	62.80 Max 2.472 Max	34.20 Min 1.347 Min	13.70 Max 0.539 Max	106.00	9.20	14.50	1.58	22.80	6850 +25%, -30%
5975011101	73.65 ±1.50 2.900	38.85 ±0.75 1.530	12.70 ±0.40 0.500	188.00	7.80	16.70	2.15	35.90	8100 ±25%
5975011121	75.65 Max 2.978 Max	37.60 Min 1.481 Min	13.60 Max 0.535 Max	188.00	7.80	16.70	2.15	35.90	8100 +25%, -30%

Quick Link: www.fair-rite.com/tor

High Permeability, 76 ($\mu_i=10,000$) material

Part Number	A	B	C	Wt. (g)	$\sum lA(\text{cm}^{-1})$	$l_e(\text{cm})$	$A_e(\text{cm}^2)$	$V_e(\text{cm}^3)$	$A_L(\text{nH})$
5976000801	3.95 ±0.15 0.155	2.15 +0.15 0.088	1.40 -0.25 0.050	0.05	87.60	0.92	0.011	0.0097	1430 ±30%
5976000101	5.95 -0.25 0.230	3.05 ±0.10 0.120	1.65 -0.25 0.060	0.14	63.80	1.30	0.02	0.027	1950 ±30%
5976000201	9.50 ±0.20 0.375	4.75 ±0.15 0.187	3.30 -0.25 0.125	0.83	28.60	2.07	0.072	0.15	4400 ±30%
5976000211	9.74 Max 0.383 Max	4.56 Min 0.180 Min	3.34 Max 0.132 Max	0.83	28.60	2.07	0.072	0.15	4400 ±30%
5976000221	10.20 Max 0.401 Max	4.10 Min 0.162 Min	3.80 Max 0.149 Max	0.83	28.60	2.07	0.072	0.15	4400 +30%, -35%
5976022121	30.10 Max 1.185 Max	17.90 Min 0.705 Min	16.00 Max 0.629 Max	27.50	9.78	7.32	0.749	5.48	12800 ±30%
5976022021	50.40 Max 1.984 Max	32.50 Min 1.278 Min	20.00 Max 0.787 Max	91.00	8.86	12.70	1.44	18.27	14200 ±30%
5976011121	75.65 Max 2.978 Max	37.60 Min 1.481 Min	13.60 Max 0.535 Max	188.00	7.80	16.50	2.14	35.30	16000 ±30%

Quick Link: www.fair-rite.com/planar

EE14/7, EE18/8, EE22/11, EE32/13, EE38/16, EE43/19, EE64/21
 EI 14/5, EI 18/6, EI 22/7, EI 32/10, E 64/15
 ER9.5, ER11, ER14.5

Planar EE and EI cores, with their low profile are suitable for board level installation allowing assembly without the need for plastic coilformers and can also allow windings integrated into multi-level PCBs. Planar ER cores with their low mass and low profile are suitable for Surface Mount installations in low power filter and transformer applications.

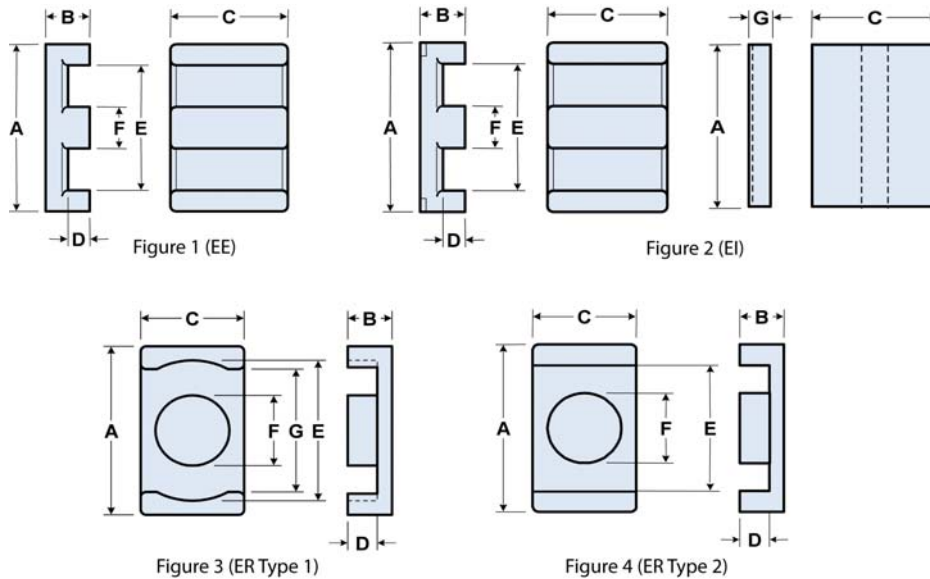

- Planar EE, ER and EI cores can be supplied with the center post gapped to a mechanical dimension, or an A_L value.
- A_L value is measured at 1 kHz, $B < 10$ gauss.
- Weight indicated is per pair or set.

Quick Link: www.fair-rite.com/planar

Legend: Symbols & Definition

Dimensions (Top numbers are in millimeters, bottom numbers are in nominal inches.)

$\Sigma \ell/A$: Core Constant, ℓ_e : Effective Path Length, A_e : Effective Cross-Sectional Area, V_e : Effective Core Volume, A_L : Inductance Factor ($\frac{L}{N^2}$)

Explanation of part numbers: Digits 1 & 2 = product class, 3 & 4 = material grade.

Dimensions

Row #	Part Number	Fig.	Generic Size	A	B	C	D	E	F	G	Wt. (g) per Set
(1)	9478201002 9498201002 9495201002	1	EE14/7	14.00 ± 0.3 0.551	3.50 ± 0.1 0.138	5.00 ± 0.15 0.197	1.90 min 0.075 min	10.52 min 0.414 min	3.00 ± 0.3 0.118		1.20
(2)	9478202002 9498202002 9495202002	1	EE18/8	18.00 ± 0.4 0.709	4.00 ± 0.1 0.157	10.00 ± 0.2 0.394	1.80 min 0.071 min	13.70 min 0.539 min	4.00 ± 0.1 0.157		4.80
(3)	9478203002 9498203002 9495203002	1	EE22/11	21.80 ± 0.4 0.858	5.70 ± 0.2 0.224	15.80 ± 0.35 0.622	3.20 ± 0.2 0.126	16.80 ± 0.4 0.661	5.00 ± 0.2 0.197		13.00
(4)	9478204002 9498204002 9495204002	1	EE32/13	31.75 ± 0.65 1.250	6.35 ± 0.2 0.250	20.35 ± 0.45 0.801	3.18 ± 0.2 0.125	24.50 min 0.965 min	6.35 ± 0.15 0.250		26.00
(5)	9478205002 9498205002 9495205002	1	EE38/16	38.10 ± 0.8 1.500	8.25 ± 0.25 0.325	25.40 ± 0.5 1.000	4.45 ± 0.25 0.175	30.23 min 1.190 min	7.60 ± 0.2 0.299		50.00
(6)	9478206002 9498206002 9495206002	1	EE43/19	43.20 ± 0.6 1.701	9.55 ± 0.3 0.376	27.90 ± 0.4 1.098	5.70 ± 0.3 0.224	34.40 min 1.354 min	8.15 ± 0.3 0.321		70.00
(7)	9478207002 9498207002 9495207002	1	EE64/21	64.00 ± 1 2.520	10.35 ± 0.15 0.407	51.00 ± 0.8 2.008	5.30 ± 0.25 0.209	53.80 ± 1 2.118	10.30 ± 0.2 0.406		200.00
(8)	7878400121 7898400121 7895400121	2	EI 14/5	14.00 ± 0.3 0.551	3.50 ± 0.1 0.138	5.00 ± 0.15 0.197	1.90 min 0.075 min	10.52 min 0.414 min	3.00 ± 0.1 0.118	1.80 ± 0.1 0.071	1.10
(9)	7878400221 7898400221 7895400221	2	EI 18/6	18.00 ± 0.35 0.709	4.00 ± 0.15 0.157	10.00 ± 0.3 0.394	1.80 min 0.071 min	13.70 min 0.539 min	4.00 ± 0.2 0.157	2.40 ± 0.15 0.094	4.10
(10)	7878400321 7898400321 7895400321	2	EI 22/8	21.80 ± 0.4 0.858	5.70 ± 0.15 0.224	15.80 ± 0.35 0.622	3.20 ± 0.15 0.126	16.80 ± 0.4 0.661	5.00 ± 0.2 0.197	2.50 ± 0.15 0.098	10.50
(11)	7878400421 7898400421 7895400421	2	EI 32/10	31.75 ± 0.5 1.250	6.35 ± 0.15 0.250	20.32 ± 0.4 0.800	3.18 ± 0.15 0.125	24.50 min 0.965 min	6.35 ± 0.2 0.250	3.18 ± 0.15 0.125	24.00
(12)	7878400721 7898400721 7895400721	2	EI 64/15	64.00 ± 1 2.520	10.35 ± 0.15 0.407	51.00 ± 0.8 2.008	5.30 ± 0.25 0.209	53.80 ± 1 2.118	10.30 ± 0.2 0.406	5.08 ± 0.2 0.200	178.00
(13)	9578100502 9598100502 9595100502	3	ER9.5	9.35 ± 0.3 0.368	2.45 ± 0.15 0.096	4.90 ± 0.2 0.193	1.68 ± 0.11 0.066	7.65 ± 0.3 0.301	3.40 ± 0.15 0.134	7.00 min 0.276 min	0.70
(14)	9578110502 9598110502 9595110502	3	ER11	10.80 ± 0.3 0.425	2.45 ± 0.15 0.096	5.90 ± 0.2 0.232	1.58 ± 0.16 0.062	8.85 ± 0.3 0.348	4.15 ± 0.2 0.163	7.90 min 0.312 min	1.00
(15)	9578150602 9598150602 9595150602	4	ER14.5	14.50 ± 0.2 0.571	2.95 ± 0.1 0.116	6.70 ± 0.1 0.264	1.65 ± 0.1 0.065	11.80 ± 0.2 0.465	4.70 ± 0.1 0.185	n/a n/a	1.80

Quick Link: www.fair-rite.com/planar

Magnetic Core Parameters

Table Continued ...

Row #	Part Number	$\sum lA(\text{cm}^{-1})$	$l_e(\text{cm})$	$A_e(\text{cm}^2)$	$V_e(\text{cm}^3)$	$A_{\min}(\text{cm}^2)$	$A_L(\text{nH})$
(1)	9478201002 9498201002 9495201002	13.40	2.01	0.153	0.315	0.15	1050 ±25% 1100 ±25% 1300 ±25%
(2)	9478202002 9498202002 9495202002	6.00	2.43	0.395	0.96	0.39	2600 ±25% 2700 ±25% 3300 ±25%
(3)	9478203002 9498203002 9495203002	4.10	3.24	0.79	2.56	0.79	4500 ±25% 4600 ±25% 5500 ±25%
(4)	9478204002 9498204002 9495204002	3.20	4.17	1.29	5.38	1.27	6200 ±25% 6400 ±25% 7600 ±25%
(5)	9478205002 9498205002 9495205002	3.00	5.29	1.90	10.10	1.80	8200 ±25% 8800 ±25% 10100 ±25%
(6)	9478206002 9498206002 9495206002	2.80	6.21	2.21	13.70	2.15	7300 ±25% 7200 ±25% 9500 ±25%
(7)	9478207002 9498207002 9495207002	1.54	8.07	5.20	41.50	5.15	14800 ±25% 14800 ±25% 18000 ±25%
(8)	7878400121 7898400121 7895400121	10.90	1.66	0.152	0.252	0.15	1440 ±25% 1440 ±25% 1600 ±25%
(9)	7878400221 7898400221 7895400221	4.90	2.05	0.421	0.863	0.40	3200 ±25% 3300 ±25% 3800 ±25%
(10)	7878400321 7898400321 7895400321	3.30	2.61	0.79	2.06	0.79	5400 ±25% 5500 ±25% 6200 ±25%
(11)	7878400421 7898400421 7895400421	2.70	3.52	1.30	4.57	1.29	7200 ±25% 7300 ±25% 8700 ±25%
(12)	7878400721 7898400721 7895400721	1.40	7.00	5.18	36.30	5.15	16900 ±25% 18000 ±25% 22200 ±25%
(13)	9578100502 9598100502 9595100502	15.20	1.361	0.0893	0.122	0.076	900 ±25% 900 ±25% 950 ±25%
(14)	9578110502 9598110502 9595110502	11.20	1.40	0.126	0.177	0.103	1200 ±25% 1250 ±25% 1350 ±25%
(15)	9578150602 9598150602 9595150602	10.80	1.90	0.176	0.333	0.17	1400 ±25% 1430 ±25% 1610 ±25%

P9/5S, P11/7S, P14/8, P18/11, P22/13, P26/16, P30/19, P36/22

Pot cores have found application in all types of inductive devices. The core configuration provides a high degree of self-shielding. It also facilitates gapping to enhance utility for a variety of magnetic designs.

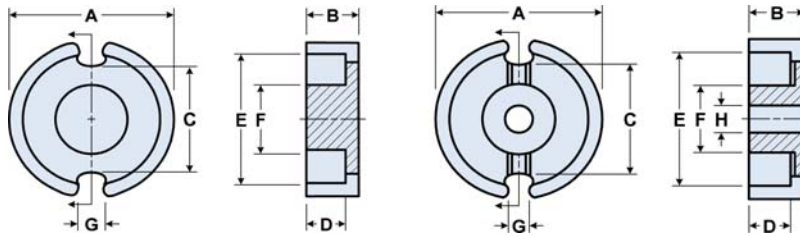

Figure 1

Figure 2

- Pot cores can be supplied with the center post gapped to a mechanical dimension or an A_L value.
- A_L value is measured at 1 kHz, $B < 10$ gauss.
- Weight indicated is per pair or set.

Legend: Symbols & Definition

Dimensions (Top numbers are in millimeters, bottom numbers are in nominal inches.)	
$\Sigma \ell/A$: Core Constant,	ℓ_e : Effective Path Length, A_e : Effective Cross-Sectional Area, V_e : Effective Core Volume, A_L : Inductance Factor ($\frac{L}{N^2}$)

Explanation of part numbers: Digits 1 & 2 = product class, 3 & 4 = material grade.

Dimensions

Row #	Part Number	Fig.	Generic Size	A	B	C	D	E	F	G	H	Wt. (g) per Set
(1)	5678090621 5698090621 5695090621	1	P9/5S	9.15 ±0.15 0.360	2.65 ±0.1 0.104	5.65 ±0.15 0.222	1.80 min 0.071 min	7.50 min 0.295 min	3.80 ±0.1 0.150	2.10 ±0.3 0.083		1.00
(2)	5678110821 5698110821 5695110821	1	P11/7S	11.10 ±0.2 0.437	3.30 ±0.1 0.130	6.80 ±0.25 0.268	2.30 ±0.15 0.091	9.20 ±0.2 0.362	4.60 ±0.1 0.181	2.20 ±0.3 0.087		1.90
(3)	5678140921 5698140921 5695140921	2	P14/8	14.00 ±0.3 0.551	4.20 ±0.2 0.165	9.55 ±0.3 0.376	3.10 ±0.2 0.122	11.80 ±0.4 0.465	5.90 ±0.2 0.232	3.30 ±0.6 0.130	2.90 ±0.3 0.114	3.20
(4)	5678181221 5698181221 5695181221	2	P18/11	18.00 ±0.4 0.709	5.35 ±0.15 0.211	13.40 ±0.4 0.528	3.80 ±0.2 0.150	14.90 min 0.587 min	7.45 ±0.15 0.293	4.00 ±0.3 0.157	3.20 ±0.2 0.126	6.00
(5)	5678221421 5698221421 5695221421	2	P22/13	21.60 ±0.4 0.850	6.70 ±0.1 0.264	14.90 ±1.6 0.587	4.70 ±0.15 0.185	18.20 ±0.4 0.717	9.25 ±0.15 0.364	3.70 ±0.7 0.146	4.55 ±0.15 0.179	12.00
(6)	5678261721 5698261721 5695261721	2	P26/16	25.50 ±0.5 1.004	8.05 ±0.15 0.317	17.20 ±0.5 0.677	5.65 ±0.2 0.222	21.60 ±0.4 0.850	11.10 ±0.3 0.437	4.15 ±0.5 0.163	5.40 ±0.25 0.213	20.00
(7)	5678302021 5698302021 5695302021	2	P30/19	30.00 ±0.5 1.181	9.40 ±0.2 0.370	20.60 min 0.811 min	6.60 ±0.2 0.260	25.00 min 0.984 min	13.30 ±0.2 0.524	3.68 min 0.145 min	5.60 ±0.2 0.220	34.00
(8)	5678362321 5698362321 5695362321	2	P36/22	35.60 ±0.6 1.402	10.90 ±0.2 0.429	26.20 ±0.6 1.031	7.60 ±0.3 0.299	29.50 min 1.161 min	15.90 ±0.3 0.626	5.15 ±0.4 0.203	5.45 ±0.25 0.215	54.00

Quick Link: www.fair-rite.com/pc

Magnetic Core Parameters

Table Continued ...

Row #	Part Number	$\sum lA(\text{cm}^{-1})$	$l_e(\text{cm})$	$A_e(\text{cm}^2)$	$V_e(\text{cm}^3)$	$A_{\min}(\text{cm}^2)$	$A_L(\text{nH})$
(1)	5678090621 5698090621 5695090621	12.00	1.35	0.112	0.152	0.09	1300 ±25% 1250 ±25% 1400 ±25%
(2)	5678110821 5698110821 5695110821	9.50	1.65	0.173	0.284	0.145	1680 ±25% 1750 ±25% 1900 ±25%
(3)	5678140921 5698140921 5695140921	7.90	1.98	0.251	0.495	0.198	1950 ±25% 1950 ±25% 2100 ±25%
(4)	5678181221 5698181221 5695181221	6.00	2.59	0.43	1.12	0.36	2600 ±25% 2700 ±25% 3400 ±25%
(5)	5678221421 5698221421 5695221421	4.80	3.12	0.648	2.00	0.51	4000 ±25% 4100 ±25% 5000 ±25%
(6)	5678261721 5698261721 5695261721	4.40	3.80	0.867	3.31	0.74	4800 ±25% 5000 ±25% 5500 ±25%
(7)	5678302021 5698302021 5695302021	3.56	4.53	1.27	5.75	1.14	5700 ±25% 5800 ±25% 7500 ±25%
(8)	5678362321 5698362321 5695362321	2.90	5.53	1.84	9.78	1.64	8300 ±25% 8500 ±25% 10000 ±25%

RM4, RM5, RM6, RM8, RM10, RM12, RM14

RM (Rectangular Modulus) cores allow better shielding than E type geometries while also providing easier winding accessibility and better power dissipation than a pot core configuration. Fair-Rite's standard RM cores all have a solid center post and standard height, low profile and alternate materials are available upon request.

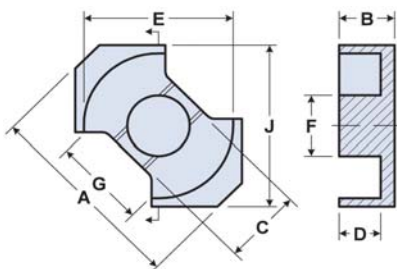

Figure 1

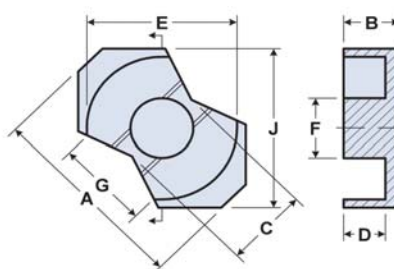

Figure 2

- RM cores can be supplied with the center post gapped to a mechanical dimension or an A_L value.
- A_L value is measured at 1 kHz, $B < 10$ gauss.
- Weight indicated is per pair or set.

Legend: Symbols & Definition

Dimensions (Top numbers are in millimeters, bottom numbers are in nominal inches.)

$\Sigma \ell/A$: Core Constant, ℓ_e : Effective Path Length, A_e : Effective Cross-Sectional Area, V_e : Effective Core Volume, A_L : Inductance Factor ($\frac{L}{N^2}$)

Explanation of part numbers: Digits 1 & 2 = product class, 3 & 4 = material grade.

Dimensions

Row #	Part Number	Fig.	Generic Size	A	B	C	D	E	F	G	J	Wt. (g) per Set
(1)	6278110121 6298110121 6295110121	1	RM4	10.75 ± 0.25 0.423	5.25 ± 0.1 0.207	4.50 ± 0.1 0.177	3.65 ± 0.15 0.144	8.15 ± 0.2 0.321	3.80 ± 0.1 0.150	5.80 min 0.228 min	9.60 ± 0.2 0.378	1.70
(2)	6278140121 6298140121 6295140121	1	RM5	14.30 ± 0.3 0.563	5.20 ± 0.1 0.205	6.60 ± 0.2 0.260	3.25 ± 0.15 0.128	10.40 ± 0.2 0.409	4.80 ± 0.1 0.189	6.00 min 0.236 min	12.05 ± 0.25 0.474	3.20
(3)	6278180121 6298180121 6295180121	2	RM6	17.60 ± 0.3 0.693	6.20 ± 0.1 0.244	7.90 ± 0.3 0.311	4.25 ± 0.15 0.167	12.65 ± 0.25 0.498	6.25 ± 0.15 0.246	8.40 min 0.331 min	14.40 ± 0.3 0.567	5.50
(4)	6278230121 6298230121 6295230121	1	RM8	22.75 ± 0.45 0.896	8.20 ± 0.1 0.323	10.80 ± 0.2 0.425	5.50 ± 0.15 0.217	17.30 ± 0.3 0.681	8.40 ± 0.15 0.331	9.80 min 0.386 min	19.10 ± 0.4 0.752	13.00
(5)	6278280121 6298280121 6295280121	1	RM10	27.80 ± 0.6 1.094	9.30 ± 0.15 0.366	13.25 ± 0.25 0.522	6.40 ± 0.2 0.252	21.65 ± 0.45 0.852	10.65 ± 0.2 0.419	12.50 min 0.492 min	24.15 ± 0.55 0.951	22.00
(6)	6278370121 6298370121 6295370121	1	RM12	36.75 ± 0.75 1.447	12.25 ± 0.15 0.482	15.85 ± 0.25 0.624	8.55 ± 0.2 0.337	25.45 ± 0.55 1.002	12.60 ± 0.2 0.496	13.40 min 0.528 min	29.20 ± 0.6 1.150	46.00
(7)	6278420121 6298420121 6295420121	1	RM14	41.60 ± 0.6 1.638	15.05 ± 0.1 0.593	18.70 ± 0.3 0.736	10.55 ± 0.2 0.415	29.50 ± 0.5 1.161	14.75 ± 0.25 0.581	17.00 min 0.669 min	34.15 ± 0.65 1.344	69.00

Magnetic Core Parameters

Table Continued ...

Row #	Part Number	$\sum lA(\text{cm}^{-1})$	$l_e(\text{cm})$	$A_e(\text{cm}^2)$	$V_e(\text{cm}^3)$	$A_{\min}(\text{cm}^2)$	$A_L(\text{nH})$
(1)	6278110121 6298110121 6295110121	17.60	2.38	0.134	0.319	0.113	900 ±25% 1020 ±25% 1130 ±25%
(2)	6278140121 6298140121 6295140121	10.30	2.39	0.233	0.555	0.181	1650 ±25% 1770 ±25% 2100 ±25%
(3)	6278180121 6298180121 6295180121	9.30	3.10	0.342	1.06	0.312	2000 ±25% 2470 ±25% 2600 ±25%
(4)	6278230121 6298230121 6295230121	6.70	4.03	0.60	2.419	0.554	3000 ±25% 3100 ±25% 3500 ±25%
(5)	6278280121 6298280121 6295280121	5.30	4.79	0.898	4.306	0.884	4200 ±25% 4300 ±25% 4900 ±25%
(6)	6278370121 6298370121 6295370121	4.30	6.13	1.41	8.675	1.247	5400 ±25% 5500 ±25% 6360 ±25%
(7)	6278420121 6298420121 6295420121	3.80	7.38	1.95	14.37	1.709	6200 ±25% 6200 ±25% 7500 ±25%

Quick Link: www.fair-rite.com/pq

PQ20/16, PQ20/20, PQ26/20, PQ26/25, PQ32/20, PQ32/30, PQ35/35, PQ40/40, PQ50/50

PQ cores were developed for use in power applications. The large surface area to volume of the core aids in heat dissipation. PQ cores are employed both in filter and transformer designs for switch mode power supplies.

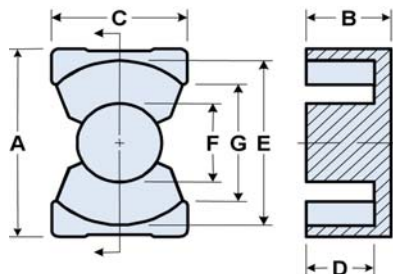

- PQ cores can be supplied with the centerpost gapped to a mechanical dimension or an A_L value.
- A_L value is measured at 1 kHz, $B < 10$ gauss.
- Weight indicated is per pair or set.

Legend: Symbols & Definition

Dimensions (Top numbers are in millimeters, bottom numbers are in nominal inches.)

$\Sigma \ell/A$: Core Constant, ℓ_e : Effective Path Length, A_e : Effective Cross-Sectional Area, V_e : Effective Core Volume, A_L : Inductance Factor ($\frac{L}{N^2}$)

Explanation of part numbers: Digits 1 & 2 = product class, 3 & 4 = material grade.

Dimensions

Row #	Part Number	Generic Size	A	B	C	D	E	F	G	Wt. (g) per Set
(1)	6678211621 6698211621 6695211621	PQ20/16	20.50 ± 0.4 0.807	8.00 ± 0.15 0.315	14.00 ± 0.4 0.551	5.00 ± 0.15 0.197	18.00 ± 0.4 0.709	8.80 ± 0.2 0.346	12.00 min 0.472 min	13.00
(2)	6678212021 6698212021 6695212021	PQ20/20	20.50 ± 0.4 0.807	10.20 ± 0.15 0.402	14.00 ± 0.4 0.551	7.00 ± 0.15 0.276	18.00 ± 0.4 0.709	8.80 ± 0.2 0.346	12.00 min 0.472 min	16.00
(3)	6678272021 6698272021 6695272021	PQ26/20	26.50 ± 0.5 1.043	10.10 ± 0.15 0.398	19.00 ± 0.4 0.748	5.75 ± 0.15 0.226	22.50 ± 0.4 0.886	12.00 ± 0.3 0.472	15.50 min 0.610 min	30.00
(4)	6678272521 6698272521 6695272521	PQ26/25	26.50 ± 0.5 1.043	12.50 ± 0.15 0.492	19.00 ± 0.4 0.748	8.05 ± 0.15 0.317	22.50 ± 0.4 0.886	12.00 ± 0.3 0.472	15.50 min 0.610 min	36.00
(5)	6678322121 6698322121 6695322121	PQ32/20	32.00 ± 0.6 1.260	10.25 ± 0.15 0.404	22.00 ± 0.4 0.866	5.75 ± 0.15 0.226	27.50 ± 0.5 1.083	13.45 ± 0.3 0.530	19.00 min 0.748 min	43.00
(6)	6678323121 6698323121 6695323121	PQ32/30	32.00 ± 0.6 1.260	15.15 ± 0.15 0.596	22.00 ± 0.4 0.866	10.65 ± 0.15 0.419	27.50 ± 0.5 1.083	13.45 ± 0.3 0.530	19.00 min 0.748 min	57.00
(7)	6678353621 6698353621 6695353621	PQ35/35	35.10 ± 0.6 1.382	17.40 ± 0.2 0.685	26.00 ± 0.5 1.024	12.50 ± 0.2 0.492	32.00 ± 0.5 1.260	14.35 ± 0.25 0.565	23.50 min 0.925 min	73.00
(8)	6678404121 6698404121 6695404121	PQ40/40	40.50 ± 0.9 1.594	19.88 ± 0.13 0.783	27.93 ± 0.53 1.100	14.75 ± 0.15 0.581	36.40 min 1.433 min	14.70 ± 0.30 0.579	27.20 min 1.071 min	97.00
(9)	6678505021 6698505021 6695505021	PQ50/50	50.00 ± 0.8 1.969	25.00 ± 0.15 0.984	32.00 ± 0.6 1.260	18.10 ± 0.25 0.713	44.00 ± 0.7 1.732	20.00 ± 0.4 0.787	32.00 min 1.260 min	195.00

Magnetic Core Parameters

Table Continued ...

Row #	Part Number	$\sum lA(\text{cm}^{-1})$	$l_e(\text{cm})$	$A_e(\text{cm}^2)$	$V_e(\text{cm}^3)$	$A_{\min}(\text{cm}^2)$	$A_L(\text{nH})$
(1)	6678211621 6698211621 6695211621	6.00	3.69	0.615	2.27	0.601	3430 ±25% 3430 ±25% 3880 ±25%
(2)	6678212021 6698212021 6695212021	7.20	4.52	0.625	2.526	0.608	2920 ±25% 2920 ±25% 3500 ±25%
(3)	6678272021 6698272021 6695272021	3.72	4.48	1.203	5.385	1.131	5510 ±25% 5510 ±25% 6500 ±25%
(4)	6678272521 6698272521 6695272521	4.59	5.40	1.177	6.359	1.131	4670 ±25% 4670 ±25% 6000 ±25%
(5)	6678322121 6698322121 6695322121	3.27	5.373	1.642	8.821	1.404	6000 ±25% 6000 ±25% 7900 ±25%
(6)	6678323121 6698323121 6695323121	4.59	7.53	1.642	12.37	1.401	4500 ±25% 4500 ±25% 6500 ±25%
(7)	6678353621 6698353621 6695353621	4.82	8.82	1.83	16.13	1.617	4900 ±25% 5100 ±25% 6200 ±25%
(8)	6678404121 6698404121 6695404121	5.23	10.36	1.98	20.50	1.70	4300 ±25% 4300 ±25% 5850 ±25%
(9)	6678505021 6698505021 6695505021	3.59	11.47	3.19	36.63	3.142	6720 ±25% 6720 ±25% 8000 ±25%

EF12.6, EF16, E 187, EF20, EF25, EF32, E33/13, E 375, E42/15, E42/20, E55/21, E65/27

The E core geometry offers an economical design approach for inductive applications in a variety of power designs.

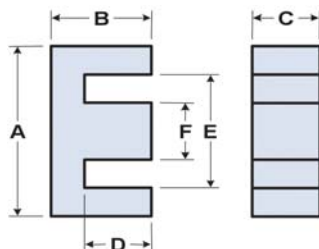

- E cores can be supplied with the center post gapped to a mechanical dimension or an A_L value.
- A_L value is measured at 1 kHz, $B < 10$ gauss.
- Weight indicated is per pair or set.

Legend: Symbols & Definition

Dimensions (Top numbers are in millimeters, bottom numbers are in nominal inches.)

$\Sigma \ell/A$: Core Constant, ℓ_e : Effective Path Length, A_e : Effective Cross-Sectional Area, V_e : Effective Core Volume, A_L : Inductance Factor ($\frac{L}{N^2}$)

Explanation of part numbers: Digits 1 & 2 = product class, 3 & 4 = material grade.

Dimensions

Row #	Part Number	Generic Size	A	B	C	D	E	F	Wt. (g) per Set
(1)	9478102002 9498102002	EF12.6	12.70 ±0.35 0.500	6.35 ±0.15 0.250	3.60 ±0.2 0.142	4.65 ±0.15 0.183	8.80 min 0.346 min	3.60 ±0.2 0.142	1.80
(2)	9478101002 9498101002	EF16	16.10 ±0.6 0.634	8.05 ±0.2 0.317	4.50 ±0.2 0.177	5.90 ±0.2 0.232	11.30 min 0.445 min	4.55 ±0.15 0.179	4.00
(3)	9478103002 9498103002 9495103002	E19/5	19.00 ±0.4 0.748	8.00 ±0.3 0.315	4.80 ±0.3 0.189	5.75 ±0.25 0.226	13.80 min 0.543 min	4.50 ±0.3 0.177	4.60
(4)	9478104002 9498104002	EF20	20.00 ±0.6 0.787	9.90 ±0.2 0.390	5.65 ±0.25 0.222	7.20 ±0.2 0.283	14.10 min 0.555 min	5.70 ±0.2 0.224	7.40
(5)	9478105002 9498105002	EF25	25.05 ±0.65 0.986	12.55 ±0.25 0.494	7.20 ±0.3 0.283	8.95 ±0.25 0.352	17.50 min 0.689 min	7.25 ±0.25 0.285	16.00
(6)	9478110002 9498110002 9495110002	EF32	32.10 ±0.6 1.264	16.10 ±0.3 0.634	9.15 ±0.35 0.360	11.50 ±0.3 0.453	22.70 min 0.894 min	9.20 ±0.3 0.362	32.00
(7)	9478111002 9498111002 9495111002	E33/13	33.00 ±0.6 1.299	14.00 ±0.3 0.551	12.70 ±0.3 0.500	9.60 ±0.3 0.378	22.80 min 0.898 min	9.70 ±0.3 0.382	40.20
(8)	9478112002 9498112002 9495112002	E35/9	34.50 ±1 1.358	14.35 ±0.35 0.565	9.50 ±0.4 0.374	9.70 ±0.3 0.382	25.40 min 1.000 min	9.40 ±0.3 0.370	29.90
(9)	9478114002 9498114002	E42/15	42.00 ±0.7 1.654	21.20 ±0.3 0.835	14.90 ±0.3 0.587	15.15 ±0.3 0.596	29.50 min 1.161 min	11.90 ±0.3 0.469	88.00
(10)	9478115002 9498115002	E42/20	42.00 ±0.7 1.654	21.20 ±0.3 0.835	19.85 ±0.35 0.781	15.15 ±0.3 0.596	29.50 min 1.161 min	11.90 ±0.3 0.469	112.00
(11)	9478116002 9498116002	E55/21	55.15 ±1.05 2.171	27.50 ±0.3 1.083	20.60 ±0.4 0.811	18.80 ±0.3 0.740	37.50 min 1.476 min	16.95 ±0.25 0.667	216.00
(12)	9478117002 9498117002	E65/27	65.20 ±1.3 2.567	32.50 ±0.3 1.280	26.90 ±0.5 1.059	22.55 ±0.35 0.888	44.20 min 1.740 min	19.65 ±0.35 0.774	410.00

Magnetic Core Parameters

Table Continued ...

Row #	Part Number	$\sum lA(\text{cm}^{-1})$	$l_e(\text{cm})$	$A_e(\text{cm}^2)$	$V_e(\text{cm}^3)$	$A_{\min}(\text{cm}^2)$	$A_L(\text{nH})$
(1)	9478102002 9498102002	23.40	2.96	0.127	0.376	0.122	800 ±25% 800 ±25%
(2)	9478101002 9498101002	19.30	3.77	0.196	0.739	0.189	950 ±25% 1000 ±25%
(3)	9478103002 9498103002 9495103002	18.10	3.99	0.22	0.878	0.216	1150 ±25% 1200 ±25% 1400 ±25%
(4)	9478104002 9498104002	15.00	4.63	0.309	1.43	0.30	1400 ±25% 1450 ±25%
(5)	9478105002 9498105002	11.40	5.79	0.509	2.95	0.49	1800 ±25% 1900 ±25%
(6)	9478110002 9498110002 9495110002	9.07	7.45	0.821	6.11	0.79	2600 ±25% 2800 ±25% 3350 ±25%
(7)	9478111002 9498111002 9495111002	5.60	6.65	1.19	7.90	1.12	4000 ±25% 4200 ±25% 5000 ±25%
(8)	9478112002 9498112002 9495112002	8.10	6.97	0.86	5.99	0.79	2800 ±25% 2900 ±25% 3500 ±25%
(9)	9478114002 9498114002	5.53	9.79	1.77	17.30	1.74	4300 ±25% 4600 ±25%
(10)	9478115002 9498115002	4.17	9.79	2.35	23.10	2.31	5200 ±25% 5200 ±25%
(11)	9478116002 9498116002	3.50	12.40	3.49	43.10	3.42	6500 ±25% 6500 ±25%
(12)	9478117002 9498117002	2.80	14.70	5.31	78.10	5.29	7600 ±25% 7900 ±25%

EFD10, EFD12, EFD15, EFD20, EFD25, EFD30

EFD (Economical Flat Design) cores have been designed to maximize volume in a low profile geometry. EFD cores allow maximum throughput power density with reasonably low mass for board level installation.

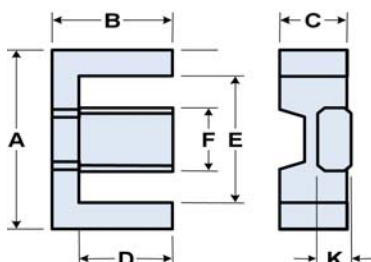

- EFD cores can be supplied with the center post gapped to a mechanical dimension or an A_L value.
- A_L value is measured at 1 kHz, $B < 10$ gauss.
- Weight indicated is per pair or set.

Legend: Symbols & Definition

Dimensions (Top numbers are in millimeters, bottom numbers are in nominal inches.)

$\Sigma \ell/A$: Core Constant, ℓ_e : Effective Path Length, A_e : Effective Cross-Sectional Area, V_e : Effective Core Volume, A_L : Inductance Factor ($\frac{L}{N^2}$)

Explanation of part numbers: Digits 1 & 2 = product class, 3 & 4 = material grade.

Dimensions

Row #	Part Number	Generic Size	A	B	C	D	E	F	K	Wt. (g) per Set
(1)	8978101021 8998101021 8995101021	EFD10	10.50 ± 0.3 0.413	5.20 ± 0.15 0.205	2.70 ± 0.2 0.106	3.75 ± 0.15 0.148	7.65 ± 0.3 0.301	4.55 ± 0.2 0.179	1.45 ± 0.1 0.057	0.90
(2)	8978121221 8998121221 8995121221	EFD12	12.50 ± 0.35 0.492	6.20 ± 0.15 0.244	3.50 ± 0.2 0.138	4.55 ± 0.15 0.179	9.00 ± 0.35 0.354	5.40 ± 0.2 0.213	2.00 ± 0.1 0.079	1.80
(3)	8978151521 8998151521 8995151521	EFD15	15.00 ± 0.4 0.591	7.50 ± 0.15 0.295	4.65 ± 0.2 0.183	5.50 ± 0.15 0.217	11.00 ± 0.4 0.433	5.30 ± 0.2 0.209	2.40 ± 0.1 0.094	2.80
(4)	8978202021 8998202021 8995202021	EFD20	20.00 ± 0.55 0.787	10.00 ± 0.25 0.394	6.65 ± 0.2 0.262	7.70 ± 0.25 0.303	15.40 ± 0.5 0.606	8.90 ± 0.3 0.350	3.60 ± 0.15 0.142	7.00
(5)	8978252521 8998252521 8995252521	EFD25	25.00 ± 0.5 0.984	12.50 ± 0.25 0.492	9.10 ± 0.3 0.358	9.30 ± 0.25 0.366	18.70 ± 0.6 0.736	11.40 ± 0.2 0.449	5.20 ± 0.2 0.205	16.00
(6)	8978303021 8998303021 8995303021	EFD30	30.00 ± 0.8 1.181	15.00 ± 0.25 0.591	9.10 ± 0.3 0.358	11.20 ± 0.3 0.441	22.40 ± 0.75 0.882	14.60 ± 0.3 0.575	4.90 ± 0.2 0.193	24.00

Quick Link: www.fair-rite.com/efd

Magnetic Core Parameters

Table Continued ...

Row #	Part Number	$\sum lA(\text{cm}^{-1})$	$l_e(\text{cm})$	$A_e(\text{cm}^2)$	$V_e(\text{cm}^3)$	$A_{\min}(\text{cm}^2)$	$A_L(\text{nH})$
(1)	8978101021 8998101021 8995101021	32.70	2.36	0.072	0.171	0.066	530 ±25% 540 ±25% 610 ±25%
(2)	8978121221 8998121221 8995121221	25.90	2.84	0.11	0.311	0.108	710 ±25% 730 ±25% 850 ±25%
(3)	8978151521 8998151521 8995151521	22.30	3.44	0.154	0.531	0.127	880 ±25% 910 ±25% 1050 ±25%
(4)	8978202021 8998202021 8995202021	15.60	4.74	0.31	1.44	0.29	1200 ±25% 1200 ±25% 1400 ±25%
(5)	8978252521 8998252521 8995252521	10.40	5.88	0.58	3.32	0.55	2200 ±25% 2250 ±25% 2650 ±25%
(6)	8978303021 8998303021 8995303021	11.30	6.93	0.69	4.26	0.66	2800 ±25% 2150 ±25% 2800 ±25%

ETD29, ETD34, ETD39, ETD44, ETD49, ETD54, ETD59

ETD cores have been designed to make optimum use of a given volume of ferrite material for maximum throughput power, specifically for forward converter transformers. The structure, which includes a round center post, approaches a nearly uniform cross-sectional area throughout the core and provides a winding area that minimizes winding losses. ETD cores are used mainly in switched-mode power supplies and permit off-line designs where IEC and VDE isolation requirements must be met.

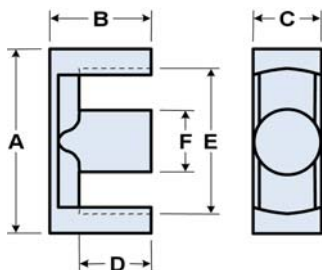

- ETD cores can be supplied with the center post gapped to a mechanical dimension or an A_L value.
- A_L value is measured at 1 kHz, $B < 10$ gauss
- Weight indicated is per pair or set.

Legend: Symbols & Definition

Dimensions (Top numbers are in millimeters, bottom numbers are in nominal inches.)

$\Sigma \ell / A$: Core Constant, ℓ_e : Effective Path Length, A_e : Effective Cross-Sectional Area, V_e : Effective Core Volume, A_L : Inductance Factor ($\frac{L}{N^2}$)

Explanation of part numbers: Digits 1 & 2 = product class, 3 & 4 = material grade.

Dimensions

Row #	Part Number	Generic Size	A	B	C	D	E	F	Wt. (g) per Set
(1)	9578293202 9598293202 9595293202	ETD29	29.80 ± 0.6 1.173	15.80 ± 0.2 0.622	9.50 ± 0.3 0.374	11.00 ± 0.2 0.433	22.00 min 0.866 min	9.50 ± 0.3 0.374	28.00
(2)	9578343502 9598343502 9595343502	ETD34	34.20 ± 0.65 1.346	17.30 ± 0.2 0.681	10.80 ± 0.3 0.425	12.10 ± 0.2 0.476	25.60 min 1.008 min	10.80 ± 0.3 0.425	40.00
(3)	9578394002 9598394002 9595394002	ETD39	39.10 ± 0.7 1.539	19.80 ± 0.2 0.780	12.70 ± 0.35 0.500	14.60 ± 0.2 0.575	29.30 min 1.154 min	12.70 ± 0.35 0.500	60.00
(4)	9578444502 9598444502 9595444502	ETD44	44.00 ± 0.75 1.732	22.30 ± 0.2 0.878	14.80 ± 0.35 0.583	16.50 ± 0.2 0.650	32.50 min 1.280 min	14.80 ± 0.35 0.583	94.00
(5)	9578494902 9598494902 9595494902	ETD49	49.00 ± 0.8 1.929	24.70 ± 0.2 0.972	16.30 ± 0.4 0.642	18.10 ± 0.2 0.713	36.10 min 1.421 min	16.30 ± 0.4 0.642	124.00
(6)	9578545402 9598545402 9595545402	ETD54	54.20 ± 1 2.134	27.10 ± 0.3 1.067	18.90 ± 0.4 0.744	19.50 ± 0.3 0.768	40.50 min 1.594 min	18.90 ± 0.3 0.744	180.00
(7)	9578606002 9598606002 9595606002	ETD59 (EER60)	59.80 ± 1 2.354	30.00 ± 0.25 1.181	21.70 ± 0.4 0.854	22.55 ± 0.25 0.888	43.60 min 1.717 min	21.70 ± 0.4 0.854	274.00

Quick Link: www.fair-rite.com/etd

Magnetic Core Parameters

Table Continued ...

Row #	Part Number	$\sum lA(\text{cm}^{-1})$	$l_e(\text{cm})$	$A_e(\text{cm}^2)$	$V_e(\text{cm}^3)$	$A_{\min}(\text{cm}^2)$	$A_L(\text{nH})$
(1)	9578293202 9598293202 9595293202	9.50	7.07	0.767	5.418	0.709	2200 ±25% 2200 ±25% 2900 ±25%
(2)	9578343502 9598343502 9595343502	8.20	7.90	0.972	7.68	0.916	2500 ±25% 2600 ±25% 3570 ±25%
(3)	9578394002 9598394002 9595394002	7.20	9.24	1.28	11.85	1.267	3000 ±25% 3000 ±25% 3600 ±25%
(4)	9578444502 9598444502 9595444502	6.00	10.35	1.73	17.94	1.717	3600 ±25% 3800 ±25% 5100 ±25%
(5)	9578494902 9598494902 9595494902	5.30	11.44	2.135	24.42	2.09	4000 ±25% 4000 ±25% 5700 ±25%
(6)	9578545402 9598545402 9595545402	4.70	12.56	2.65	33.30	2.40	5300 ±25% 5400 ±25% 6500 ±25%
(7)	9578606002 9598606002 9595606002	3.90	13.87	3.57	49.52	3.23	6650 ±25% 6950 ±25% 8430 ±25%

EER25.5/18, EER28/28, EER28/34, EER35/42, EER40/46, EER42/44, EER49/54

EER cores, similar to ETD cores, have been designed to make optimum use of a given volume of ferrite material for maximum throughput power. The structure, which includes a round center post, approaches a nearly uniform cross-sectional area throughout the core and provides a winding area that minimizes winding losses.

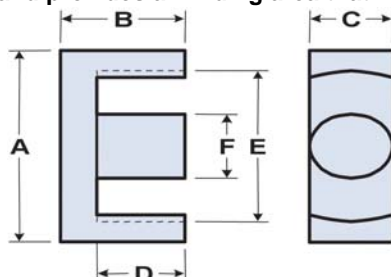

- EER cores can be supplied with the center post gapped to a mechanical dimension or an A_L value.
- A_L value is measured at 1 kHz, $B < 10$ gauss.
- Weight indicated is per pair or set.

Legend: Symbols & Definition

Dimensions (Top numbers are in millimeters, bottom numbers are in nominal inches.)

$\Sigma \ell / A$: Core Constant, ℓ_e : Effective Path Length, A_e : Effective Cross-Sectional Area, V_e : Effective Core Volume, A_L : Inductance Factor ($\frac{\ell}{N^2}$)

Explanation of part numbers: Digits 1 & 2 = product class, 3 & 4 = material grade.

Dimensions

Row #	Part Number	Generic Size	A	B	C	D	E	F	Wt. (g) per Set
(1)	9578261802 9598261802 9595261802	EER25.5	25.50 ± 0.5 1.004	9.30 ± 0.15 0.366	7.50 ± 0.25 0.295	6.40 ± 0.15 0.252	19.80 min 0.780 min	7.50 ± 0.25 0.295	11.20
(2)	9578282802 9598282802 9595282802	EER28/28	28.50 ± 0.6 1.122	14.00 ± 0.2 0.551	11.40 ± 0.3 0.449	9.60 ± 0.2 0.378	21.20 min 0.835 min	9.90 ± 0.3 0.390	28.00
(3)	9578283402 9598283402 9595283402	EER28/34	28.50 ± 0.6 1.122	16.90 ± 0.2 0.665	11.40 ± 0.3 0.449	12.50 ± 0.2 0.492	21.20 min 0.835 min	9.90 ± 0.3 0.390	32.00
(4)	9578354202 9598354202 9595354202	EER35/42	35.00 ± 0.65 1.378	21.00 ± 0.2 0.827	11.30 ± 0.3 0.445	15.00 ± 0.2 0.591	25.30 min 0.996 min	11.30 ± 0.3 0.445	46.00
(5)	9578404602 9598404602 9595404602	EER40/46	40.00 ± 0.7 1.575	22.90 ± 0.3 0.902	13.30 ± 0.3 0.524	15.90 ± 0.3 0.626	29.50 min 1.161 min	13.30 ± 0.3 0.524	80.00
(6)	9578424402 9598424402 9595424402	EER42/44	42.00 ± 0.7 1.654	22.00 ± 0.2 0.866	15.20 ± 0.35 0.598	15.40 ± 0.2 0.606	30.50 min 1.201 min	15.20 ± 0.35 0.598	96.00
(7)	9578495402 9598495402 9595495402	EER49/54	49.00 ± 0.8 1.929	27.00 ± 0.2 1.063	17.20 ± 0.35 0.677	18.70 ± 0.2 0.736	36.50 min 1.437 min	17.20 ± 0.35 0.677	158.00

Quick Link: www.fair-rite.com/eer

Magnetic Core Parameters

Table Continued ...

Row #	Part Number	$\sum lA(\text{cm}^{-1})$	$l_e(\text{cm})$	$A_e(\text{cm}^2)$	$V_e(\text{cm}^3)$	$A_{\min}(\text{cm}^2)$	$A_L(\text{nH})$
(1)	9578261802 9598261802 9595261802	11.10	4.80	0.434	2.083	0.425	1800 ±25% 1800 ±25% 2200 ±25%
(2)	9578282802 9598282802 9595282802	7.30	6.29	0.859	5.398	0.77	2800 ±25% 2800 ±25% 3500 ±25%
(3)	9578283402 9598283402 9595283402	8.70	7.44	0.852	6.337	0.77	2600 ±25% 2710 ±25% 3350 ±25%
(4)	9578354202 9598354202 9595354202	8.20	9.11	1.11	10.14	1.00	2600 ±25% 2800 ±25% 3200 ±25%
(5)	9578404602 9598404602 9595404602	6.90	10.00	1.44	14.42	1.30	3400 ±25% 3600 ±25% 4200 ±25%
(6)	9578424402 9598424402 9595424402	5.20	9.79	1.87	18.26	1.81	4000 ±25% 4100 ±25% 5900 ±25%
(7)	9578495402 9598495402 9595495402	4.80	11.80	2.45	29.02	2.32	4200 ±25% 5350 ±25% 6500 ±25%

The U core offers an economical core design with a nearly uniform cross-sectional area. In a power ferrite material they are frequently used in output chokes, power input filters and transformers for switched-mode power supplies and HF fluorescent ballasts.

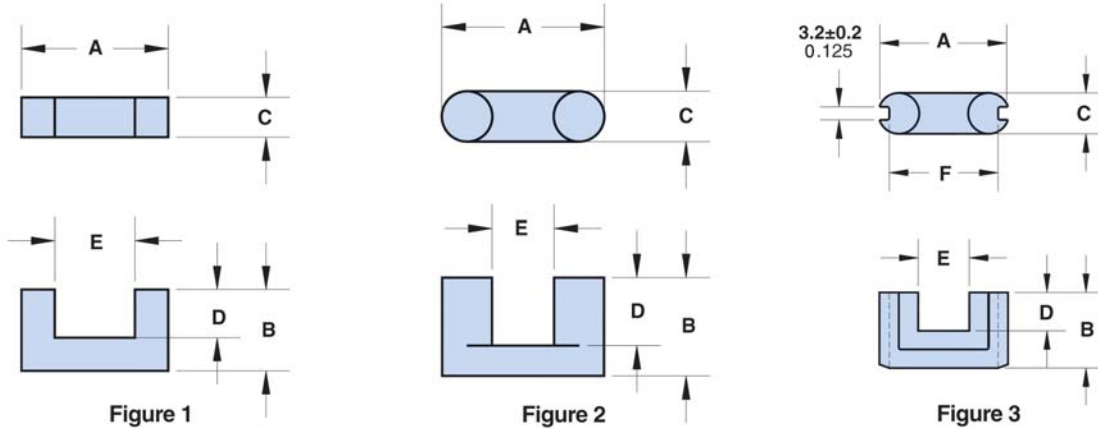

- These U cores have the same minimum cross-sectional area as the listed effective cross-sectional area.
- A_L value is measured at 1kHz, < 10 gauss.
- For any U core requirement not listed in the catalog, please contact our customer service group for availability and pricing.
- Explanation of Part Numbers: Digits 1&2 = product class, 3&4 = material grade.
- Weight indicated is per pair or set.

Legend: Symbols & Definition

Dimensions (Top numbers are in millimeters, bottom numbers are in nominal inches.)

$\Sigma \ell/A$: Core Constant, ℓ_e : Effective Path Length, A_e : Effective Cross-Sectional Area, V_e : Effective Core Volume, A_L : Inductance Factor ($\frac{L}{N^2}$)

Explanation of part numbers: Digits 1 & 2 = product class, 3 & 4 = material grade.

MnZn 77 material

Row #	Part Number	Fig.	A	B	C	D	E	F	Wt. (g) per Set
(1)	9077002002	1	8.90 -0.50 0.340	4.45 +0.25 0.180	4.05 ±0.20 0.160	1.30 Min 0.051 Min	2.30 Min 0.090 Min	—	1.40
(2)	9077026002	1	25.40 ±0.75 1.000	12.60 ±0.25 0.500	6.60 -0.50 0.250	6.20 Min 0.244 Min	12.45 Min 0.490 Min	—	15.00
(3)	9077025002	1	25.40 ±0.75 1.000	15.75 ±0.25 0.625	6.60 -0.50 0.250	9.40 Min 0.370 Min	12.45 Min 0.490 Min	—	17.50
(4)	9077024002	1	25.40 ±0.75 1.000	18.90 ±0.25 0.750	6.60 -0.50 0.250	12.55 Min 0.494 Min	12.45 Min 0.490 Min	—	20.00
(5)	9277023002	2	26.50 ±0.70 1.045	15.75 ±0.25 0.625	10.00 -0.50 0.385	10.00 Min 0.394 Min	7.25 Min 0.285 Min	—	28.00
(6)	9277002002	2	26.50 ±0.70 1.045	20.20 ±0.15 0.795	10.00 -0.50 0.385	14.35 Min 0.565 Min	7.25 Min 0.285 Min	—	32.00
(7)	9277024002	3	31.40 ±0.60 1.237	18.50 ±0.15 0.729	10.25 -0.50 0.394	9.40 Min 0.370 Min	12.50 Min 0.492 Min	26.60 ±0.5 1.047	35.00
(8)	9277008002	3	41.15 ±0.75 1.620	17.45 ±0.15 0.687	11.70 ±0.25 0.460	7.80 Min 0.307 Min	18.65 Min 0.735 Min	35.30 ±0.60 1.390	50.00
(9)	9277010002	3	41.15 ±0.75 1.620	20.50 ±0.25 0.812	11.70 ±0.25 0.460	10.95 Min 0.430 Min	18.65 Min 0.735 Min	35.30 ±0.60 1.390	54.00
(10)	9277012002	3	41.15 ±0.75 1.620	25.40 ±0.15 1.000	11.70 ±0.25 0.460	15.75 Min 0.620 Min	18.65 Min 0.735 Min	35.30 ±0.60 1.390	66.00

Quick Link: www.fair-rite.com/uc

Table Continued ...

Row #	Part Number	$\sum lA(\text{cm}^{-1})$	$l_e(\text{cm})$	$A_e(\text{cm}^2)$	$V_e(\text{cm}^3)$	$A_L(\text{nH})$
(1)	9077002002	16.80	2.08	0.124	0.257	695 Min
(2)	9077026002	17.60	7.10	0.40	2.85	940 Min
(3)	9077025002	20.70	8.40	0.40	3.36	790 Min
(4)	9077024002	23.90	9.60	0.40	3.88	695 Min
(5)	9277023002	11.60	7.80	0.67	5.20	1390 Min
(6)	9277002002	13.90	9.50	0.68	6.50	1180 Min
(7)	9277024002	11.20	9.30	0.83	7.70	1425 Min
(8)	9277008002	10.50	10.30	0.98	10.10	1575 Min
(9)	9277010002	11.80	11.60	0.98	11.30	1425 Min
(10)	9277012002	13.80	13.50	0.98	13.20	1255 Min

Quick Link: www.fair-rite.com/ep

EP7, EP10, EP13, EP17, EP20

EP designs reduce the effect of residual air gap upon the effective permeability of the core, hence they minimize coil volume for a given inductance. EP cores also provide a high degree of isolation from adjacent components and are advantageously used in low power devices, matching and broadband transformers.

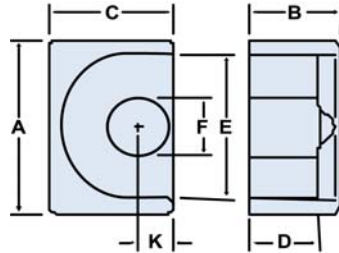

- EP cores can be supplied with the center post gapped to a mechanical dimension or an A_L value.
- A_L value is measured at 1 kHz, $B < 10$ gauss
- Weigh indicates is per pair or set.

Legend: Symbols & Definition

Dimensions (Top numbers are in millimeters, bottom numbers are in nominal inches.)

$\Sigma \ell / A$: Core Constant, ℓ_e : Effective Path Length, A_e : Effective Cross-Sectional Area, V_e : Effective Core Volume, A_L : Inductance Factor ($\frac{L}{N^2}$)

Explanation of part numbers: Digits 1 & 2 = product class, 3 & 4 = material grade.

Dimensions

Row #	Part Number	Generic Size	A	B	C	D	E	F	K	Wt. (g) per Set
(1)	6578070121 6598070121 6595070121	EP7	9.20 ± 0.2 0.362	3.70 ± 0.2 0.146	6.40 ± 0.2 0.252	2.70 ± 0.2 0.106	7.20 min 0.283 min	3.30 ± 0.1 0.130	1.80 min 0.071 min	0.70
(2)	6578100121 6598100121 6595100121	EP10	11.50 ± 0.3 0.453	5.10 ± 0.2 0.201	7.70 ± 0.2 0.303	3.80 ± 0.2 0.150	9.40 ± 0.2 0.370	3.30 ± 0.2 0.130	1.95 min 0.077 min	1.40
(3)	6578130121 6598130121 6595130121	EP13	12.50 ± 0.3 0.492	6.50 ± 0.3 0.256	8.80 ± 0.2 0.346	4.70 ± 0.2 0.185	10.00 ± 0.3 0.394	4.40 ± 0.2 0.173	2.50 min 0.098 min	2.35
(4)	6578170121 6598170121 6595170121	EP17	18.10 ± 0.4 0.713	8.40 ± 0.4 0.331	11.00 ± 0.3 0.433	5.70 ± 0.2 0.224	12.00 ± 0.4 0.472	5.70 ± 0.2 0.224	3.45 min 0.136 min	6.00
(5)	6578200121 6598200121 6595200121	EP20	24.00 ± 0.5 0.945	10.70 ± 0.2 0.421	15.00 ± 0.4 0.591	7.20 ± 0.2 0.283	16.50 ± 0.4 0.650	8.80 ± 0.2 0.346	4.70 min 0.185 min	13.50

Quick Link: www.fair-rite.com/ep

Magnetic Core Parameters

Table Continued ...

Row #	Part Number	$\sum lA(\text{cm}^{-1})$	$l_e(\text{cm})$	$A_e(\text{cm}^2)$	$V_e(\text{cm}^3)$	$A_{\min}(\text{cm}^2)$	$A_L(\text{nH})$
(1)	6578070121 6598070121 6595070121	14.40	1.48	0.103	0.152	0.085	990 ±25% 1020 ±25% 1180 ±25%
(2)	6578100121 6598100121 6595100121	16.80	1.85	0.11	0.203	0.085	1000 ±25% 1050 ±25% 1200 ±25%
(3)	6578130121 6598130121 6595130121	11.80	2.32	0.197	0.457	0.148	1600 ±25% 1650 ±25% 1800 ±25%
(4)	6578170121 6598170121 6595170121	8.00	2.68	0.336	0.899	0.252	2250 ±25% 2300 ±25% 2750 ±25%
(5)	6578200121 6598200121 6595200121	4.80	3.76	0.789	2.96	0.60	4100 ±25% 4250 ±25% 5000 ±25%

Product Capability

1. We like to be challenged! If your requirements call for an unusual core configuration, don't give up if you can't find it in existing ferrite catalogs. Give us a call. Usually all we need to get started on your design is some preliminary information, such as the operating frequency and estimated usage.

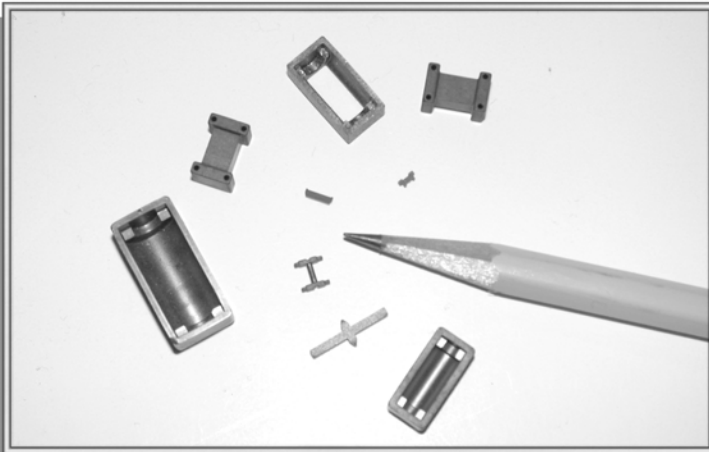
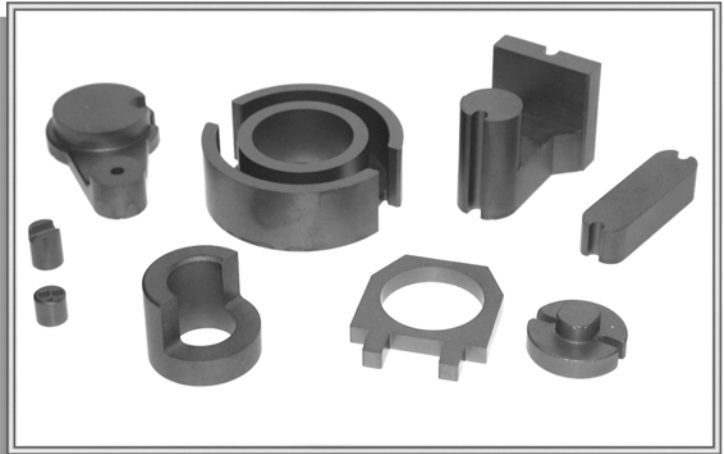

2. Precise small components are one of our specialties. We have a range of NiZn and MnZn ferrite material grades to accommodate small inductive component designs. If specific tooling is required to manufacture *your* part, that tool will only be used to manufacture *your* design.

3. Fair-Rite Products Corp. manufactures a range of rods with centerless ground diameters down to 0.5 mm (0.020") and lengths up to 10 mm (0.395"). We can also supply pressed rods with a diameter as small as 0.5 mm and 2-3 mm long. We are fully equipped to Parylene coat rods if required. Sorting for length is also possible.

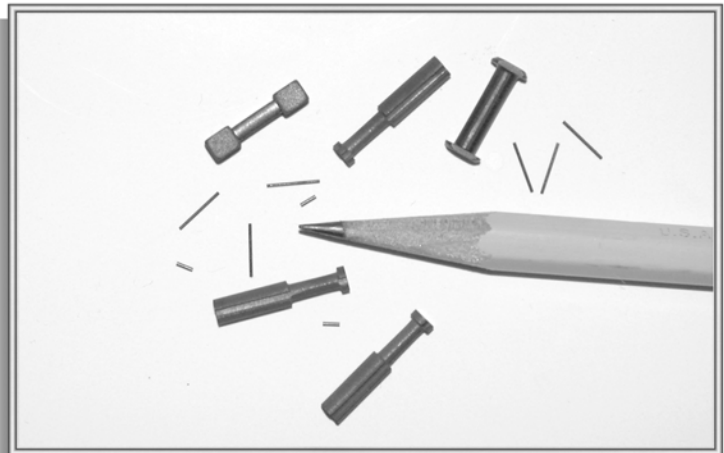

Fair-Rite Products Corp. PO Box 288, One Commercial Row, Wallkill, NY 12589-0288

Product Capability

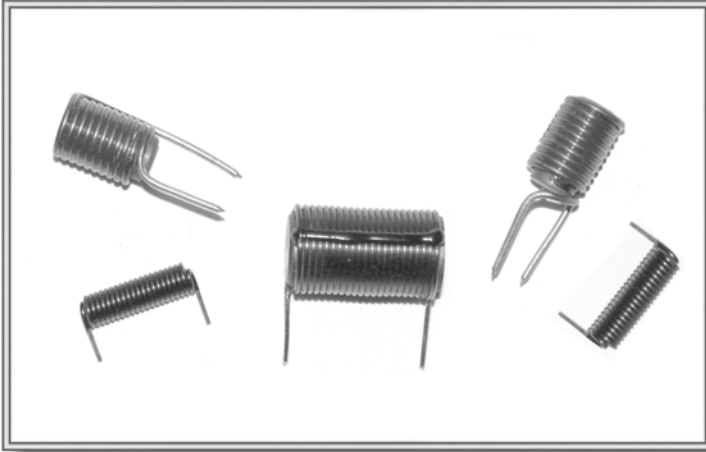

4. Our pressed rods and centerless ground rods can also be supplied as wound rods. We offer several material grades for these product lines. To be cost-competitive, these rods are wound in one of our manufacturing facilities in China.

5. We can supply application customer specific parts in one of our ferrite materials to facilitate the design process. Prior to deciding on the final core shape and material selection, machined samples can be provided for testing purposes.

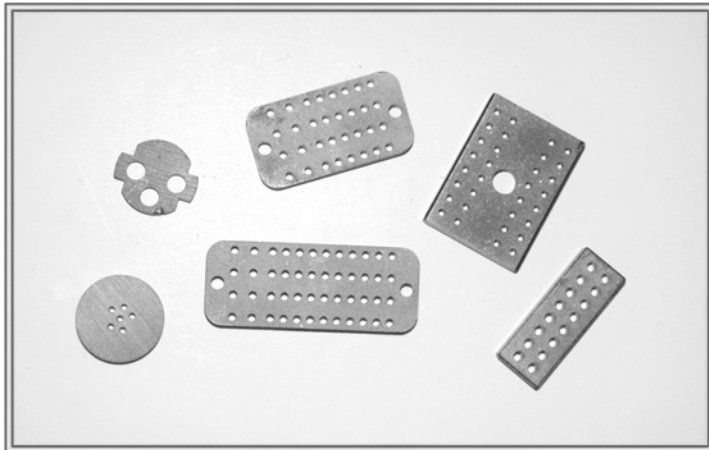
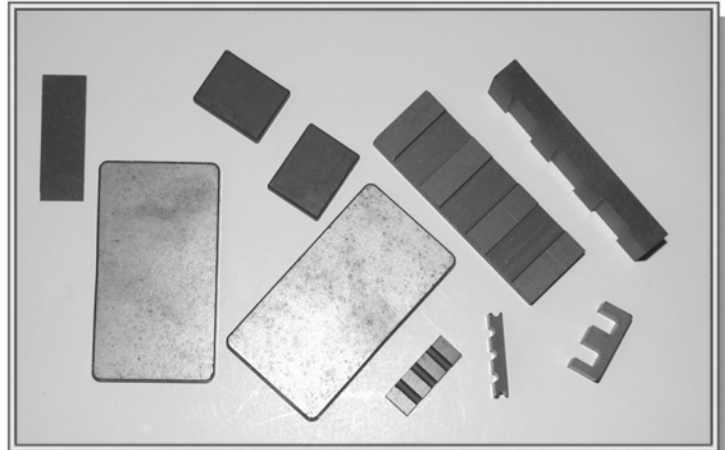

6. Over the years we've tooled a diverse range of connector plate configurations in our NiZn 44 and 61 material. Tooling can be expensive, depending upon the complexity of the connector plate, and only sizeable annual quantities make this solution cost-effective. Again, before a design is finalized, machined prototypes can be supplied to verify your design's viability.

Fair-Rite Products Corp. PO Box 288, One Commercial Row, Wallkill, NY 12589-0288

Phone: (888) FAIR RITE / (845) 895-2055 • Fax: (888) FERRITE / (845) 895-2629 • Web: www.fair-rite.com
(888) 324-7748 (888) 337-7483 E -mail: ferrites@fair-rite.com

Reference Tables

Ferrite Material Constants

Specific Heat	0.25 cal/g/°C
Thermal Conductivity	3.5 - 4.5 mW/cm - °C
Coefficient of Linear Expansion	8 - 10x10 ⁻⁶ /°C
Tensile Strength	4.9 kgf/mm ²
Compressive Strength	42 kgf/mm ²
Young's Modulus	15x10 ³ kgf/mm ²
Hardness (Knoop)	650
Specific Gravity	≈ 4.7

The above quoted properties are typical for Fair-Rite MnZn and NiZn ferrites.

Properties of Parylene C Coating Material

Dielectric Strength	5600	V/mil
Volume Resistivity	8.8x10 ¹⁶	ohm-cm
Surface Resistivity	10 ¹⁴	ohm
Dielectric Constant (1MHz)	2.95	
Dissipation Factor (1MHz)	0.013	
Density	1.29	g/cm ³
Water Absorption (24 hrs)	<0.1	%
Coefficient of Friction	0.29	
Continuous Operating Temperature	<100	°C
Thermal Conductivity	2.0x10 ⁻⁴	cal/sec/cm/°C
Maximum Operating Temperature	<160	°C

Conversion Table

SI Units	CGS Units
1 T (tesla) = 1 Vs/m ²	= 10 ⁴ gauss
1 mT	= 10 gauss
1 A/m = 10 ⁻² A/cm	= 0.0125 oersted
.1 mT	= 1 gauss
80 A/m	= 1 oersted

Greek Alphabet

A, α	Alpha	N, ν	Nu
B, β	Beta	Ξ, ξ	Xi
Γ, γ	Gamma	O, ο	Omicron
Δ, δ	Delta	Π, π	Pi
E, ε	Epsilon	Ρ, ρ	Rho
Z, ζ	Zeta	Σ, σ	Sigma
H, η	Eta	Τ, τ	Tau
Θ, θ	Theta	Υ, υ	Upsilon
I, ι	Iota	Φ, φ	Phi
K, κ	Kappa	X, χ	Chi
Λ, λ	Lambda	Ψ, ψ	Psi
M, μ	Mu	Ω, ω	Omega

Glossary of Terms

Air Core Inductance - L_o (henry)

The inductance that would be measured if the core had unity permeability and the flux distribution remained unaltered.

Coercive Force - H_c (oersted or A/m)

The magnetizing field strength required to bring the magnetic flux density of the magnetized material to zero.

Core Constant - C_1 (cm^{-1})

The summation of the magnetic path lengths of each section of a magnetic circuit divided by the corresponding magnetic area of the same section.

Core Constant - C_2 (cm^{-3})

The summation of the magnetic path lengths of each section of a magnetic circuit divided by the square of the corresponding magnetic area of the same section.

Curie Temperature - T_c ($^{\circ}\text{C}$)

The transition temperature above which a ferrite loses its ferrimagnetic properties.

Disaccommodation - D

The proportional decrease of permeability after a disturbance of magnetic material, measured at constant temperature, over a given time interval.

Disaccommodation Factor - DF

The disaccommodation factor if the disaccommodation after magnetic conditioning divided by the permeability of the first measurement times \log_{10} of the ratio of time intervals.

Effective Dimensions of a Magnetic Circuit -

Area A_e (cm^2), Path Length l_e (cm) and Volume V_e (cm^3)

For a magnetic core of given geometry, the magnetic path length, the cross-sectional area and the volume that a hypothetical toroidal core of the same material properties should possess to be the magnetic equivalent to the given core.

Field Strength - H (oersted or A/m)

The parameter characterizing the amplitude of the alternating field strength.

Flux Density - B (gauss or mT)

The corresponding parameter for the induced magnetic field in an area perpendicular to the flux path.

Flux Density, saturation - B_s (gauss or mT)

The maximum intrinsic induction possible in a material.

Inductance Factor - A_L (nH)

Inductance of a coil on a specified core divided by the square of the number of turns. (Unless otherwise specified the inductance test conditions for the inductance factor are at flux density <10gauss).

Loss Factor - $\tan \delta/\mu_i$

The phase of displacement between the fundamental components of the flux density and the field strength divided by the initial permeability.

Magnetic Constant - μ_o

The permeability of free space.

Magnetic Hysteresis

In the magnetic material, the irreversible variation of the flux density or the magnetization which is associated with the change of magnetic field strength and is independent of the rate change.

Magnetically Soft Material

A magnetic material with low coercivity.

Permeability, amplitude - μ_a

The quotient of the peak value of the flux density and the peak value of the applied field strength at a stated amplitude of either, with no static present.

Permeability, complex series - μ_s', μ_s''

The real and imaginary components respectively of the complex permeability expressed in series terms.

Permeability, effective - μ_e

For a magnetic circuit constructed with an air gap or air gaps, the permeability of a hypothetical homogeneous material which would provide the same reluctance.

Permeability, incremental - μ_{Δ}

Under stated conditions the permeability obtained from the ratio of the flux density and the applied field strength of an alternating field and a superimposed static field.

Permeability, initial - μ_i

The permeability obtained from the ratio of the flux density, kept at <10 gauss, and the required applied field strength. Material initially in a specified neutralized state.

Power Loss Density - P (mW/cm³)

The power absorbed by a body of ferrimagnetic material and dissipated as heat, when the body is subject to an alternating field which results in a measurable temperature rise. The total loss is divided by the volume of the body.

Remanence - B_r (gauss or mT)

The flux density remaining in a magnetic material when the applied magnetic field strength is reduced to zero.

Temperature Coefficient - TC

The relative change of the quantity considered, divided by the difference in the temperatures producing it.

Temperature Factor - TF

The fractional change in the initial permeability over temperature range, divided by the initial permeability.

Soft Ferrite References

IEC Publications on Soft Ferrite Materials and Components

IEC 60133	Dimensions of pot cores made of magnetic oxides and associated parts.
IEC 60205	Calculations of the effective parameters of magnetic piece parts.
IEC 60401-1	Terms and nomenclature for cores made of magnetically soft ferrites. Part 1: Terms used for physical irregularities.
IEC 60401-2	Terms and nomenclature for cores made of magnetically soft ferrites. Part 2: Reference of dimensions.
IEC 60401-3	Terms and nomenclature for cores made of magnetically soft ferrites. Part 3: Guidelines on the format of data appearing in manufacturers' catalogues of transformers and inductors cores.
IEC 60424-1	Ferrite cores. Guides on the limits of surface irregularities. Part 1: General specification.
IEC 60424-2	Guidance of the limits of surface irregularities of ferrite cores. Part 2: RM cores.
IEC 60424-3	Ferrite cores. Guide on the limits of surface irregularities. Part 3: ETD cores and E cores.
IEC 60424-4	Ferrite cores. Guide on the limits of surface irregularities. Part 4: Ring cores.
IEC 60647	Dimensions for magnetic oxide cores intended for use in power supplies (EC cores).
IEC 60732	Measuring methods for cylinder cores, tubes cores and screw cores of magnetic oxides.
IEC 61007	Transformers and inductors for use in telecommunication equipment. Measuring methods and test procedures.
IEC 61185	Magnetic oxide cores (ETD cores) intended for use in power supply applications. Dimensions.
IEC 61247	PM cores made of magnetic oxide and associated parts. Dimensions.
IEC 61332	Soft ferrite material classification.
IEC 61333	Marking on U and E ferrite cores.
IEC 61596	Magnetic oxide EP cores and associated parts for use in inductors and transformers. Dimensions.
IEC/TR 61604	Dimensions of uncoated ring cores of magnetic oxides.

Soft Ferrite References

IEC 61631	Test method for the mechanical strength of cores made of magnetic oxides.
IEC 62024-1	High frequency inductive components. Electrical characteristics and measuring methods. Part 1: Nanohenry range chip inductors.
IEC 62044-1	Cores made of soft magnetic materials. Measuring methods. Part 1: Generic specification.
IEC 62044-2	Cores made of soft magnetic materials. Measuring methods. Part 2: Magnetic Properties at low excitation level.
IEC 62044-3	Cores made of soft magnetic materials. Measuring methods. Part 3: Magnetic properties at high excitation level.
IEC 62211	Inductive components. Reliability management.
IEC 62317-1	Ferrite cores - Dimensions - Part 1: General specifications.
IEC 62317-4	Ferrite cores - Dimensions - Part 4: RM-cores and associated parts.
IEC 62317-7	Ferrite cores - Dimensions - Part 7: EER-cores
IEC 62317-8	Ferrite cores - Dimensions - Part 8: E-cores
IEC 62317-9	Ferrite cores - Dimensions - Part 9: Planar cores. Amendment 1.
IEC/PAS 62323	Dimensions of half pot cores of magnetic oxides for inductive proximity switches.
IEC 62358	Ferrite cores. Standard inductance factor (AI) and its tolerance.
IEC/TS 62398	Ferrite cores. Technology approval schedule (TAS).

The International Electrotechnical Commission (IEC) is the world organization that prepares and publishes international standards for all electrical, electronic and related technologies. Founded in 1906, the IEC is presently composed of more than 60 participating countries, including all the world's major trading nations and a growing number of industrializing countries.

The above publications have been issued by the IEC Technical Committee No. 51: Magnetic Components and Ferrite Materials. Publications can be purchased from the American National Standards Institute. Visit their web site webstore.ansi.org to purchase the documents.

Reference Books for Soft Ferrite Applications

Ferrites for Inductors and Transformers, 1983
Snelling, E.C. and Giles, A.D. , John Wiley & Sons, New York, NY

Soft Ferrites, Properties and Applications, 2nd Edition, 1988
Snelling, E.C. , Butterworths, Stoneham, MA

Transformer and Inductor Design Handbook, 1988
McLyman, Wm. T., Marcel Dekker, New York, NY

Transmission Line Transformers, 1990
Sevick, J., American Radio Relay League, Newington, CT

Soft Magnetic Materials, 1979
Boll, R., John Wiley & Sons, New York, NY

Transformers for Electronic Circuits, 2nd Edition, 1990
Grossner, N., McGraw Hill, New York, NY

Modern Ferrite Technology, Second Edition, 1999
Goldman, A., Kluwer Academic Publishers, Boston/
Dordrecht, Netherlands

Magnetic Design Formulas

Effective Core Parameters

$$C_1 = \Sigma l/A \quad (\text{cm}^{-1}) \quad C_2 = \Sigma l/A^2 \quad (\text{cm}^{-3})$$

$$\ell_e = C_1^2/C_2 \quad (\text{cm}), \quad A_e = C_1/C_2 \quad (\text{cm}^2)$$

Magnetic path is divided into elements with length ℓ and cross-sectional area A .

$$V_e = C_1^3/C_2^2 \quad (\text{cm}^3)$$

Flux Density Peak

$$\hat{B} = \frac{E 10^8}{4.44 f N A_e} \quad (\text{gauss})$$

Field Strength (Peak)

$$\hat{H} = \frac{0.4 \pi N I_p}{\ell_e} \quad (\text{oersted})$$

Where E = RMS sine wave voltage (V)
 f = Frequency (Hz)
 A_e = Effective cross-sectional area (cm²)
 ℓ_e = Effective path length (cm)
 I_p = Peak current (A)
 N = Number of turns

* To check for maximum peak flux density in a non-uniform core set substitute A_{\min} for A_e .

Air Core Inductance

$$L_o = \frac{4 \pi N^2 10^{-9}}{C_1} \quad (\text{H})$$

C_1 in cm⁻¹

Number of Turns

$$N = \sqrt{\frac{L 10^9}{A_L}} \quad L \text{ in H}$$

Inductance

$$L = N^2 A_L \quad (\text{nH})$$

$$L = \mu_i \frac{4 \pi N^2}{C_1} 10^{-9} \quad (\text{H})$$

$$L = \mu_e \frac{4 \pi N^2}{C_1} 10^{-9} \quad (\text{H}) \quad \left. \vphantom{L = \mu_e \frac{4 \pi N^2}{C_1} 10^{-9}} \right\} C_1 \text{ in cm}^{-1}$$

Effective Permeability

$$\mu_e = \frac{\ell_e}{\ell_e/\mu_i + \ell}$$

Where ℓ_e = Effective path length
 ℓ = Air gap length

Attenuation

$$A = 20 \log_{10} \frac{|Z_s + Z_L + Z_{sc}|}{|Z_s + Z_L|} \quad (\text{dB})$$

Where Z_s = Source impedance
 Z_L = Load impedance
 Z_{sc} = Suppression core impedance

Quality Factor

$$Q = \frac{2 \pi f L_s}{R_s} = \frac{R_p}{2 \pi f L_p}$$

Wire Table of Copper Magnet Wire

AWG & B&S Gauge	Diameter (Inch)	Cross-Sectional Area		Feet per Ohm (20°C)	Ohms per 1000 ft (20°C)	Amperes for 1mA/cir mil	Turns per Inch ²
		(Inch ²)	(cir mils)				
10	0.1019	0.00815	10380	1001	1.00	10.4	92
11	0.0907	0.00647	8234	794	1.26	8.25	118
12	0.0808	0.00513	6530	630	1.59	6.54	146
13	0.0719	0.00407	5178	499	2.00	5.18	180
14	0.0641	0.00322	4107	396	2.53	4.11	231
15	0.0571	0.00256	3257	314	3.18	3.26	275
16	0.0508	0.00203	2583	249	4.02	2.59	346
17	0.0453	0.00161	2048	198	5.06	2.05	432
18	0.0403	0.00127	1624	157	6.39	1.62	544
19	0.0359	0.00101	1288	124	8.05	1.29	679
20	0.0320	0.000804	1022	98.5	10.2	1.03	854
21	0.0285	0.000638	810.1	78.1	12.8	0.81	1065
22	0.0254	0.000505	642.4	62.0	16.1	0.64	1345
23	0.0226	0.000400	509.5	49.1	20.4	0.51	1675
24	0.0201	0.000317	404.0	39.0	25.7	0.40	2095
25	0.0179	0.000252	320.4	30.9	32.4	0.321	2630
26	0.0159	0.000200	254.1	24.5	40.8	0.255	3325
27	0.0142	0.000158	201.5	19.4	51.4	0.201	4110
28	0.0126	0.000126	159.8	15.4	64.9	0.160	5210
29	0.0113	0.000100	126.7	12.2	81.9	0.128	6385
30	0.0100	0.0000785	100.5	9.7	103.1	0.100	8145
31	0.0089	0.0000622	79.7	7.7	130.1	0.079	10,097
32	0.0080	0.0000503	63.2	6.1	163	0.064	12,270
33	0.0071	0.0000396	50.1	4.8	206	0.050	15,615
34	0.0063	0.0000312	39.8	3.83	261	0.040	19,655
35	0.0056	0.0000248	31.5	3.04	330	0.0316	25,530
36	0.0050	0.0000196	25.0	2.41	415	0.0250	31,405
37	0.0045	0.0000159	19.8	1.91	524	0.0203	39,570
38	0.0040	0.0000126	15.7	1.52	670	0.0160	49,070
39	0.0035	0.00000962	12.5	1.20	832	0.0122	65,790
40	0.0031	0.00000755	9.89	0.953	1049	0.0098	82,180
41	0.0028	0.00000616	7.84	0.756	1323	0.0079	98,860
42	0.0025	0.00000491	6.20	0.598	1672	0.0062	121,175
43	0.0022	0.00000380	4.93	0.476	2101	0.0048	158,245
44	0.0020	0.00000314	3.88	0.374	2674	0.0039	205,515
45	0.0018	0.00000254	3.10	0.299	3344	0.0032	249,855
46	0.0016	0.00000201	2.46	0.238	4202	0.0025	310,205

Fair-Rite Products Corp. PO Box 288, One Commercial Row, Wallkill, NY 12589-0288

Phone: (888) FAIR RITE / (845) 895-2055 • Fax: (888) FERRITE / (845) 895-2629 • Web: www.fair-rite.com
 (888) 324-7748 (888) 337-7483 E-mail: ferrites@fair-rite.com

Use of Ferrites in Broadband Transformers

Introduction

Most of the magnetic information in this catalog is data obtained from cores wound with a single multi-turn-winding which forms an inductor. When a second winding is added on the core, the inductor becomes a transformer. Depending on the requirements, transformers can be designed to provide dc isolation, impedance matching and specific current or voltage ratios. Transformer designed for power, broadband, pulse, or impedance matching can often be used over a broad frequency spectrum.

In many transformer designs ferrites are used as the core material. This article will address the properties of the ferrite materials and core geometries which are of concern in the design of low power broadband transformers.

Brief Theory

Broadband transformers are wound magnetic devices that are designed to transfer energy over a wide frequency range. Most applications for broadband transformers are in telecommunication equipment where they are extensively used at a low power levels.

Figure 1 shows a typical performance curve of insertion loss as a function of frequency for a broadband transformer. The bandwidth of a broadband transformer is the frequency difference between f_2 and f_1 , or between f_2' and f_1' , and is a function of the specified insertion loss and the transformer roll-off characteristics.

It can be seen that the bandwidth is narrower for transformers with a steep roll-off ($f_2' - f_1'$) than those with a more gradual roll-off ($f_2 - f_1$). Also in Figure 1, the three frequency regions are identified.

The cutoff frequencies are determined by the requirements of the individual broadband transformer design. Therefore, f_1 can be greater than 10 MHz or less than 300 Hz. Bandwidths also can vary from a few hundred hertz to hundreds of MHz. A typical

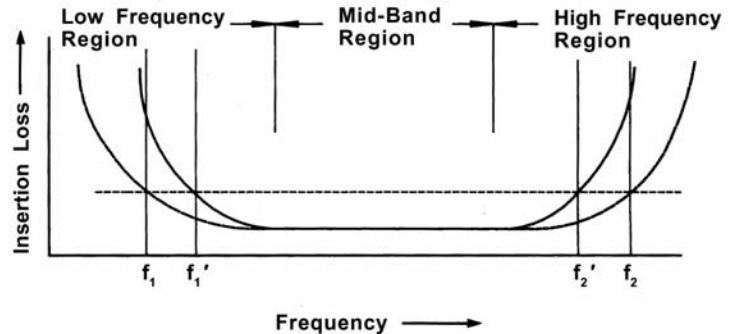

Figure 1 Typical Characteristic Curve of Insertion Loss vs. Frequency for a broadband transformer.

broadband transformer design will specify for the mid frequency range a maximum insertion loss and for the cutoff frequencies, f_1 and f_2 maximum allowable losses. Figure 2 is a schematic diagram of the lumped element equivalent circuit of a transformer, separating the circuit into an ideal transformer, its components and equivalent parasitic resistances and reactances. The secondary components, parasitics and the load resistance have been transferred to the primary side and are identified with a prime.

To simplify this circuit, the primary and secondary circuit elements have been combined and the equivalent reduced circuit is shown in Figure 3. The physical significance of the parameters are listed below the equivalent circuits. In the low frequency region the roll-off in transmission characteristics is due a lowering of the shunt impedance. The shunt impedance decreases when the frequency is reduced, which results in the increases level of attenuation. The impedance is mainly a function of the

Technical Information

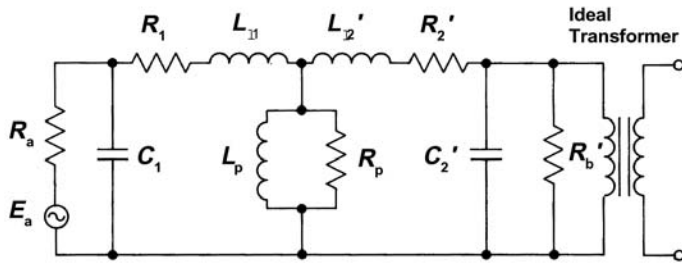

Figure 2 Lumped equivalent of a transformer.

- E_a = source EMF
- R_a = source resistance
- C_1 = primary winding capacitance
- R_1 = resistance of primary winding
- L_{t1} = primary leakage inductance
- L_p = open circuit inductance of primary winding
- R_p = shunt resistance that represents loss in core
- Secondary parameters reflected to the primary side.
- C_2' = secondary winding capacitance
- R_2' = resistance of secondary winding
- L_{t2}' = secondary leakage inductance
- R_b' = load resistance

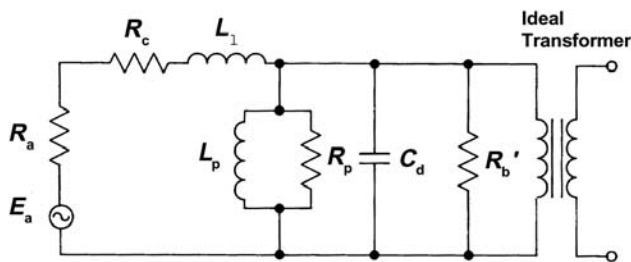

Figure 3 Simplified equivalent transformer circuit

$$C_d = C_1 + C_2'$$

$$R_c = R_1 + R_2'$$

$$L_t = L_{t1} + L_{t2}'$$

For other circuit parameters see Figure 2.

primary reactance X_{Lp} with a negligible contribution of the equivalent shunt loss resistance R_p . The insertion loss may therefore be expressed in terms of the shunt inductance:

$$A_i = 10 \log_{10} \left(1 + \left(\frac{R}{\omega L_p} \right)^2 \right) \text{ dB}$$

$$\text{Where } R = R_a \times R_b' / R_a = R_b'$$

For most ferrite broadband transformer designs, the only elements that are likely to effect the transmission at the mid-band frequency range are the winding resistances. The insertion loss for the mid-band frequency region due to the winding resistance may be expressed as:

$$A_i = 20 \log_{10} \left(1 + \frac{R_c}{R_a + R_b'} \right) \text{ dB}$$

$$\text{Where } R_c = R_1 + R_2'$$

In the higher frequency region the transmission characteristics are mainly a function of the leakage inductance or the shunt capacitance. It is often necessary to consider the effect of both of these reactances, depending upon the circuit impedance. In a low impedance circuit the high frequency droop due to leakage inductance is:

$$A_i = 10 \log_{10} \left(1 + \left(\frac{\omega L_t}{R_a + R_b'} \right)^2 \right) \text{ dB}$$

This high frequency droop in a high impedance circuit, due to the shunt capacitance, is as follows:

$$A_i = 10 \log_{10} \left(1 + (\omega C R)^2 \right) \text{ dB}$$

Reviewing the insertion loss characteristics for the three frequency regions, it can be concluded that the selection of ferrite material and core shape should result in a transformer design that yields the highest inductance per turn at the low frequency cutoff f_1 . This will result in the required shunt inductance for the low frequency region with the least number of turns. The low number of turns are desirable for low insertion loss at the mid-band region and also for low winding parasitics needed for good response at the high frequency cutoff f_2 .

Low and Medium Frequency Broadband Transformers

For broadband transformer applications the optimum ferrite is the material that has the highest initial permeability at the lower cutoff frequency f_1 . Manganese zinc ferrites, such as Fair-Rite 77 or 78 material, are very suitable for low and medium frequency broadband transformers designs. As stated before, the transformer parameter that is most critical is the shunt reactance (ωL), which will increase with frequency as long as the material permeability is constant or diminishing at a rate less than the increase in frequency. This holds true even if a transformer is designed using a manganese zinc ferrite where f_1 is at the higher end of the flat portion of the permeability vs. frequency curve. Although the whole bandpass lies in the area where the initial permeability is decreasing, yet the bandpass characteristics will be virtually unaffected. For broadband transformers that use a manganese zinc ferrite material the core geometry should be such as to minimize the R_{dc}/L ratio. In other words, the ratio of dc resistance to the inductance for a single turn should be a minimum. The range of pot cores, standardized by the International Electrotechnical Commission in document IEC 60133, has been designed for this minimum R_{dc}/L ratio. Other core shapes can also be used in the design of these broadband transformers. Often the final core selection will also be influenced by such considerations as ease of winding, terminating and other mechanical design constraints of the transformer.

Broadband Transformers with a Superimposed Static Field

In transformer designs that have a superimposed direct current, gapped cores can be employed to overcome the decrease in the shunt inductance. Hanna curves can be used to aid in the design of inductive devices that carry a direct current. For more information see section "The Effect of Direct Current on the Inductance of a Ferrite Core".

High Frequency Broadband Transformers.

Although there is no clear division between the frequency regions, for this article it is assumed that the high frequency broadband transformer designs use nickel zinc ferrites as the preferred core material. This will typically occur for transformer

designs where the bandpass lies wholly above 500 kHz. At these higher operating frequencies it becomes more important to consider the complex magnetic parameters of the core material, rather than use the simple core constants, such as A_L , recommended for low frequency designs.

Another important consideration is that high frequency transformers are generally used in low impedance circuits, which means that these designs require low shunt impedances. This can often be accomplished with a few turns, hence winding resistances are no longer an issue, and the design concept of minimizing R_{dc}/L is no longer required. The design will instead become focused on core shape and material for the required shunt impedance at f_1 along with reducing leakage inductance of the winding. Since the material characteristics permeability and losses affect the shunt impedance these parameters need to be considered in high frequency broadband transformer designs. Figures 4, 5 and 6 are typical curves of impedance Z , equivalent parallel reactance X_p and equivalent parallel loss resistance R_p as a function of frequency. They are measured on the same multi-aperture core 28—002302, in 73, 43, 61 & 67 material, wound with a single turn through both holes. For high frequency broadband transformers the toroidal core shape becomes an attractive core geometry. The few turns that are often required can easily be wound on the toroid. However, windings that require only a few turns may give rise to problems in obtaining the desired impedance ratios. To minimize leakage inductance it is suggested that the primary and secondary windings be tightly coupled and where possible a bifilar winding be used.

An improvement in core performance over toroids can be obtained by the use of multi-aperture cores, which can be considered as two toroidal cores side by side. This core shape has a lower single turn winding length than the equivalent toroidal core with the same core constant C_1 , and will result in a wider bandwidth of the transformer design. Many broadband transformers have been designed utilizing nickel zinc ferrite toroids with good results. If bandwidth requirements cannot be met using toroids, multi-aperture nickel zinc cores should be considered.

The multi-aperture cores are available in the nickel zinc ferrite materials 67, 61 and 43 as well as the manganese zinc ferrite 73 material.

Technical Information

Summary

The low cutoff frequency f_1 is the single most important factor in the ferrite material selection. The material with the highest initial permeability at f_1 is the recommended choice.

Manganese zinc ferrites, 77 and 78, can be used to a cutoff frequency f_1 of 500 kHz. Above this frequency use a nickel zinc ferrite, again depending upon the frequency f_1 , select 43, 61 or 67 material.

For low and medium frequency transformers the optimum core shape should provide the lowest DC resistance per unit of inductance. If there is a superimposed dc present the use of gapped cores and Hanna curves is suggested. For high frequency designs, use nickel zinc ferrite. The toroidal and multi-aperture cores are the recommended core configurations.

The number of turns should be kept to a minimum to reduce leakage inductance and self-capacitance of the windings. Wind primary and secondary windings tightly coupled or as bifilar windings to lower leakage inductance.

The "Multi-Aperature Core Kit", (part number 0199000036), contains a variety of components suited for broadband transformer design evaluations.

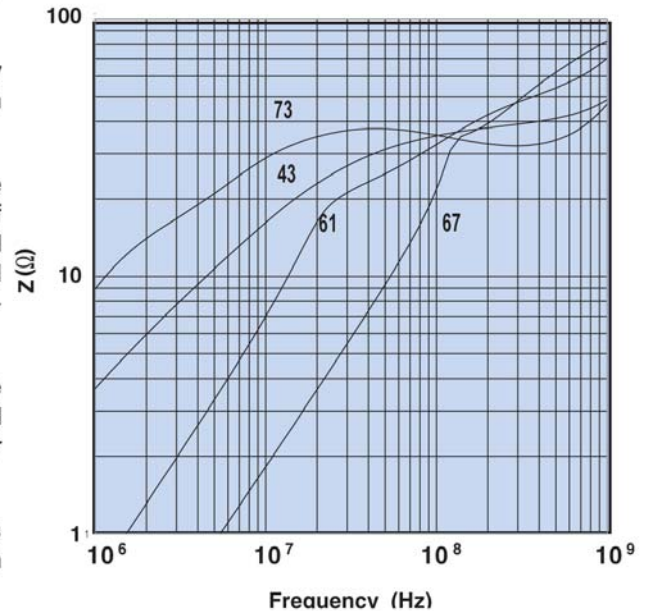

Figure 4 Impedance vs. frequency for part number 28—002302 in 73, 43, 61 & 67 material.

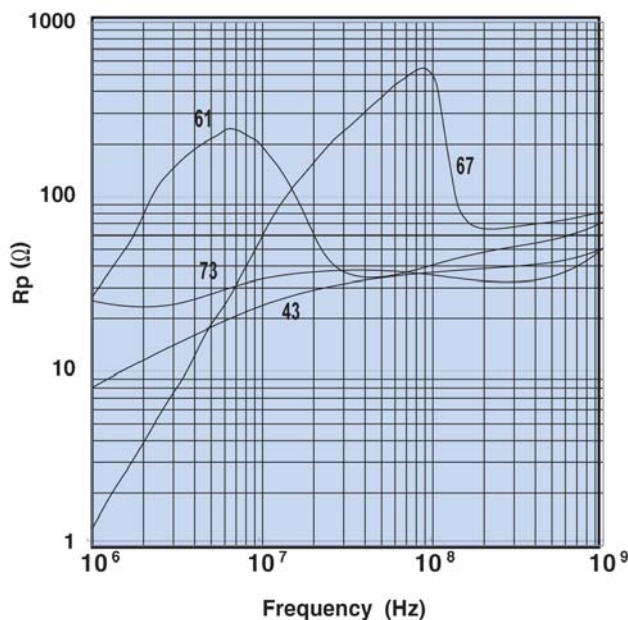

Figure 5 Parallel resistance vs. frequency for part number 28—002302 in 73, 43, 61 & 67 material.

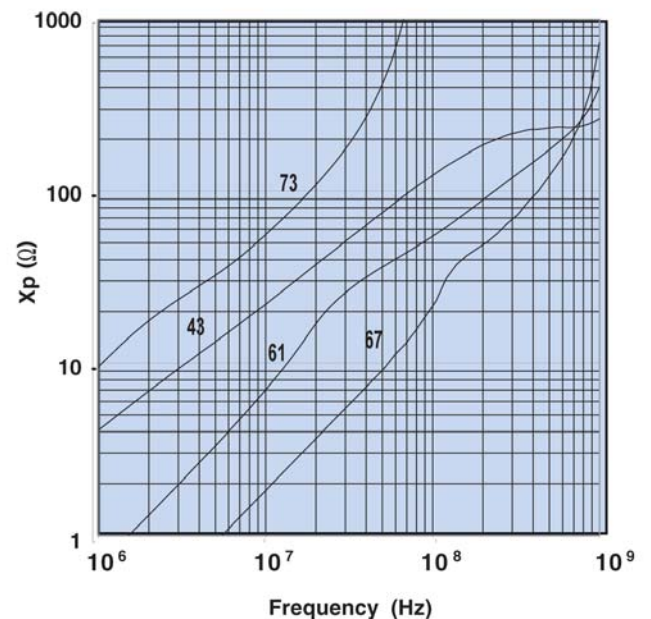

Figure 6 Parallel reactance vs. frequency for part number 28—002302 in 73, 43, 61 & 67 material.

How to Choose Ferrite Components for EMI Suppression

Introduction

The following pages will focus on Soft Ferrites used in the application of electromagnetic interference (EMI) suppression. Although the end use is an important issue and some applications are mentioned, this technical section is not intended to be a design manual, but rather, an aid to the designer in understanding and choosing the optimum ferrite material and component for their particular application. Ferrite suppressor cores are simple to use, in either initial designs or retrofits, and are comparatively economical in both price and space. Ferrite suppressors have been successfully employed for attenuating EMI in computers and related products, switching power supplies, electronic automotive ignition systems, and garage doors openers, to name just a few.

Use of Ferrite Suppressor Cores

The United States was one of the first countries to recognize the potential problems caused by electromagnetic pollution. As a result the FCC was charged with the responsibility of promulgating rules and regulations to control and enforce limits on high frequency interference.

Figure 1 shows the current radiation limits as defined by FCC Rules Part 15, for class A (industrial) and class B (mass-market) equipment.

Contrary to the times when these regulations were first enforced and designing for EMI protection was often an afterthought rather than a forethought, a major portion of today's circuitry is incorporating EMI safeguards in its initial design. Many approaches can be used to comply with design or specification limits for EMI. Attention to basic circuit design, component layout, shielded enclosures and other use of shielding materials may be considered. For reducing or eliminating conducted EMI on printed circuit boards in wiring and cables, ferrite components have been used very successfully for decades. The ferrite core introduces into the circuit a frequency variable impedance, see Figure 2. The core will not affect the lower frequency operating signals but does block the conduction of the EMI noise frequencies. The Figures 3 and 4 are photographs of a representative sampling of the Fair-Rite Products Corp. product line of suppressor cores.

Conducted Limits*		
Frequency	Class A	Class B
450 kHz – 1.6 MHz	60 dBuV	50 dBuV
1.6 MHz – 30 MHz	70 dBuV	60 dBuV

*Measured using a 50-ohm LISN

Radiated Limits**		
Frequency	Class A	Class B
30 MHz – 88 MHz	50 dBuV/m	40 dBuV/m
88 MHz – 216 MHz	53 dBuV/m	43 dBuV/m
216 MHz – 960 MHz	56 dBuV/m	46 dBuV/m
above 960 MHz	64 dBuV/m	54 dBuV/m

**Measured at a 3-meter distance

Figure 1 FCC Radiation Limits for class A & B equipment.

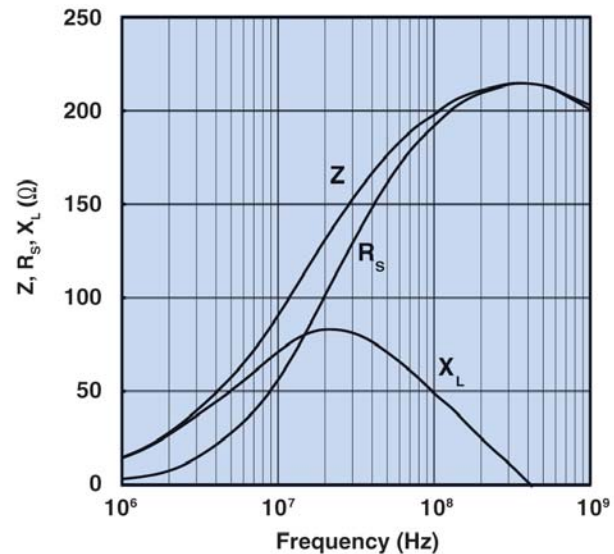

Figure 2 Impedance, reactance, and resistance vs. frequency for a ferrite core in 43 material.

Technical Information

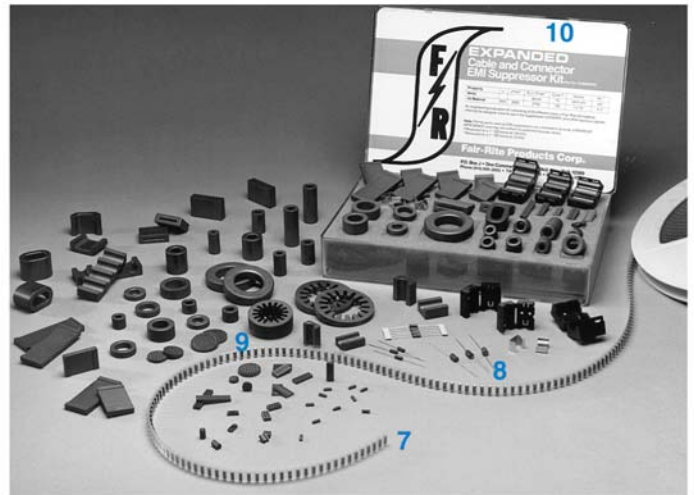
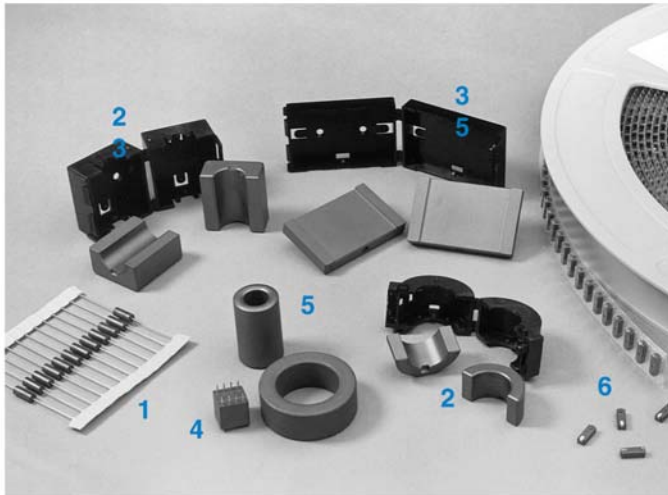

Figure 3, 4 Variety of EMI Suppression Cores including: (1) Beads on Leads, (2) Split Round Cable Suppression Cores and Cases, (3) Split Flat Cable Suppression Cores and Cases, (4) Printed Circuit (PC) Beads, (5) Round Cable Suppression Cores (6) Surface-Mount (SM) Beads, (7) on Reel, (8) Wound Beads, (9) Connector Suppression Discs and Plates and (10) One of our Engineering Kits containing a Large Variety of Samples of EMI Suppressor Cores.

The Magnetics

The permeability of a ferrite material is a complex parameter consisting of a real and an imaginary part. The real component represents the reactive portion and the imaginary component represents the losses. These may be expressed as series components (μ_s', μ_s'') or parallel components (μ_p', μ_p'').

Figure 5 is the vector representation of the series equivalent circuit of a ferrite suppression core; the loss free inductor (L_s) is in series with the equivalent loss resistor (R_s). The following equations relate the series impedance and the complex permeability:

$$Z = j\omega L_s + R_s = j\omega L_o(\mu_s' - j\mu_s'') \text{ ohm}$$

so that

$$\omega L_s = \omega L_o \mu_s' \text{ ohm}$$

$$R_s = \omega L_o \mu_s'' \text{ ohm}$$

where: $L_o = \frac{4\pi N^2 10^{-9}}{C_1}$ (H) is the air core inductance.

C_1 = core factor

The impedance of a ferrite suppressor core is a combination of the intrinsic material characteristics μ_s' and μ_s'' , the square of the turns and of the ferrite core. The complex permeability components μ_s' and μ_s'' vary as a function of frequency. The core geometry and the number of turns are frequency independent contributors to the overall impedance.

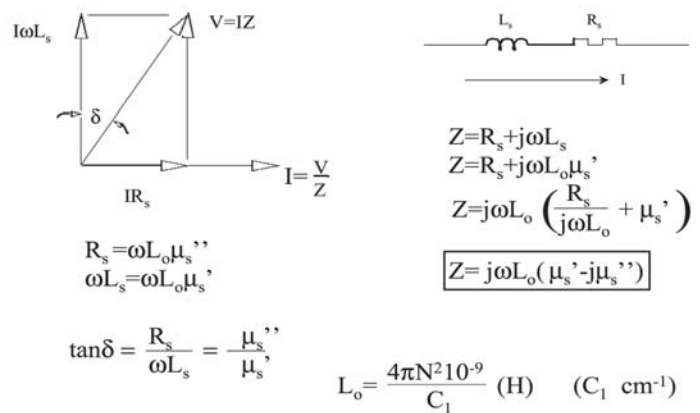

Figure 5

Material Selection

Conducted EMI can occur over a wide range of frequencies, from as low as 1 MHz to several GHz. To provide protection over such a wide frequency range a number of ferrite materials will have to be made available.

Fair-Rite offers a complete line of suppression ferrites that cover a gamut of frequencies. Starting at 1 MHz MnZn ferrites 73 and 31 are used. Beginning around 20 MHz up to 200/300 MHz the NiZn materials 43 and 44 and the MgZn 46 material are recommended. For the highest frequencies the NiZn 61 material is the choice.

Fair-Rite Products Corp. PO Box 288, One Commercial Row, Wallkill, NY 12589-0288

Phone: (888) FAIR RITE / (845) 895-2055 • Fax: (888) FERRITE / (845) 895-2629 • Web: www.fair-rite.com
(888) 324-7748 (888) 337-7483 E-mail: ferrites@fair-rite.com

Technical Information

Figures 6 through 11 show for these six suppression materials the complex permeabilities μ'_s and μ''_s as a function of frequency. For all these materials at low frequencies μ'_s is highest but as the frequency increases μ''_s becomes the dominant material parameter whence the biggest contributor to the overall impedance. At the low frequencies where μ'_s is highest the suppression core is mostly inductive and rejects EMI signals. At the higher frequencies where μ''_s becomes the more significant parameter the impedance will become more and more resistive and absorbs the conducted EMI.

Table 1 lists Fair-Rite's suppression materials, suggested operating frequency ranges and the test frequencies for the six suppression materials. The recommended materials will provide the highest combination of the primary material characteristics μ'_s and μ''_s over that frequency range.

Table 1

Material	Frequency Range	Test Frequencies	Comments
73	1 –25 MHz	10 – 25 MHz	Small parts only
31	1 – 300 MHz	10 – 25 – 100 MHz	Large parts only
43	20 – 300 MHz	25 – 100 MHz	Wide range of parts
44	20 – 300 MHz	25 – 100 MHz	High resistivity
46	20 - 300 MHz	100 MHz	Large Parts
61	200+ MHz	250 - 500 MHz	For VHF designs

Making the material selection is the first step in eliminating conducted EMI problems. To make this material selection it is imperative that the frequency or frequencies of the unwanted noise are known. This needs not be an exact figure; an approximation will be sufficient. From the EMI frequency the material can be selected. It should be made clear that several environmental conditions will have to be addressed before this selection becomes final.

Environmental Conditions

As shown in Figures 6 through 11, the μ'_s and μ''_s will vary as a function of frequency. However, several environmental conditions will also affect these primary material parameters. The most significant ones are temperature and dc bias.

Changes in the combination of μ'_s and μ''_s due to temperature is strictly a material characteristic which is not affected by the core geometry. The graphs in Figures 12 through 17 show the percentage change in impedance as a function of temperature when compared to room temperature. These typical changes in impedance will be applicable for all components made from these materials. Designers can use these graphs to evaluate performance of specific components versus temperature.

73 Material

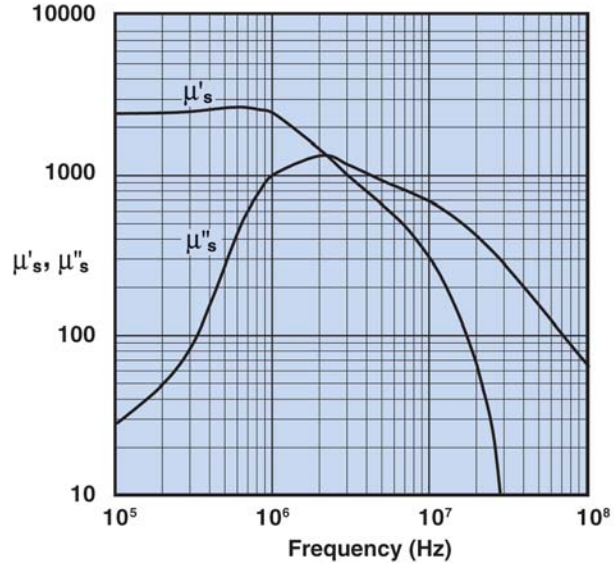

Figure 6 Complex Permeability vs. Frequency Measured on a 2673000301 bead using the HP 4284A and the HP 4291A.

31 Material

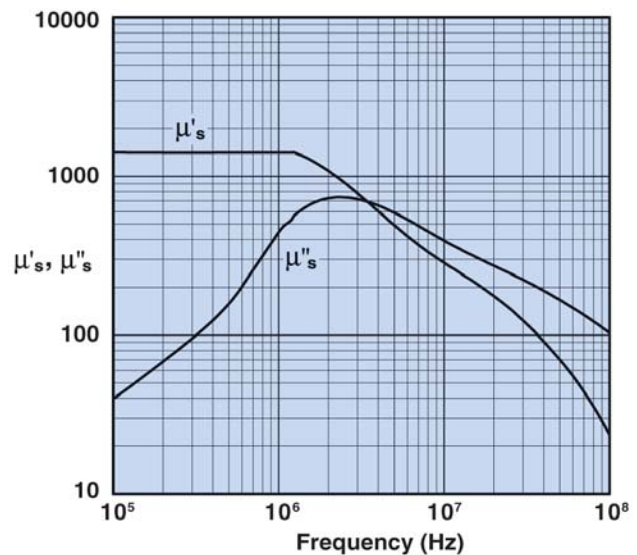

Figure 7 Complex Permeability vs. Frequency Measured on a 17/10/6mm toroid using the HP 4284A and the HP 4291A.

Technical Information

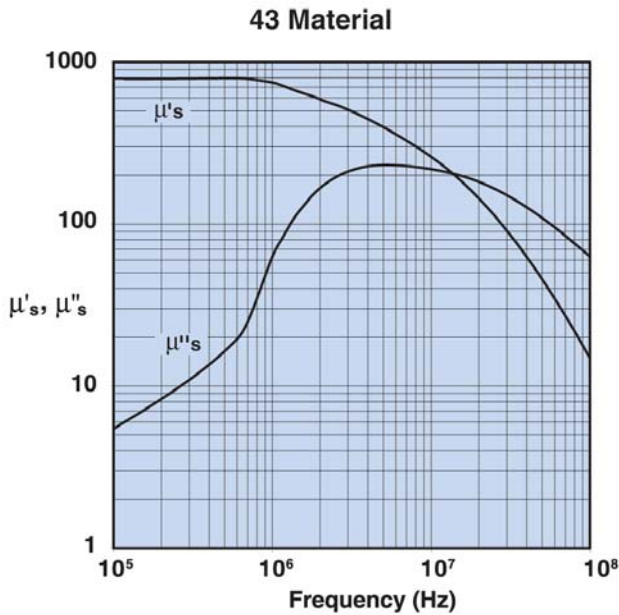

Figure 8 Complex Permeability vs. Frequency Measured on a 17/10/6mm toroid using the HP 4284A and the HP 4291A.

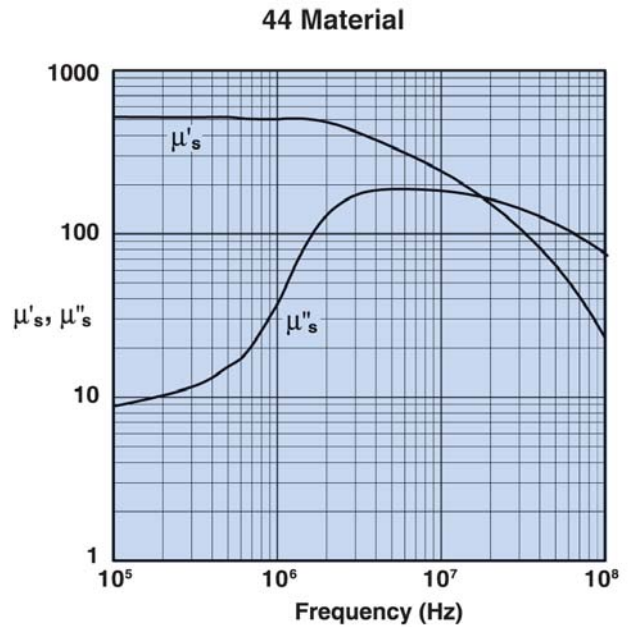

Figure 9 Complex Permeability vs. Frequency Measured on a 17/10/6mm toroid using the HP 4284A and the HP 4291A

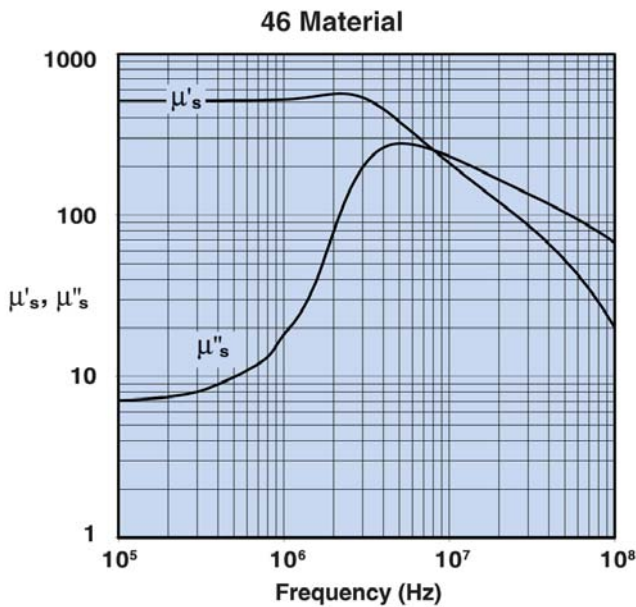

Figure 10 Complex Permeability vs. Frequency Measured on a 17/10/6mm toroid using the HP 4284A and the HP 4291A.

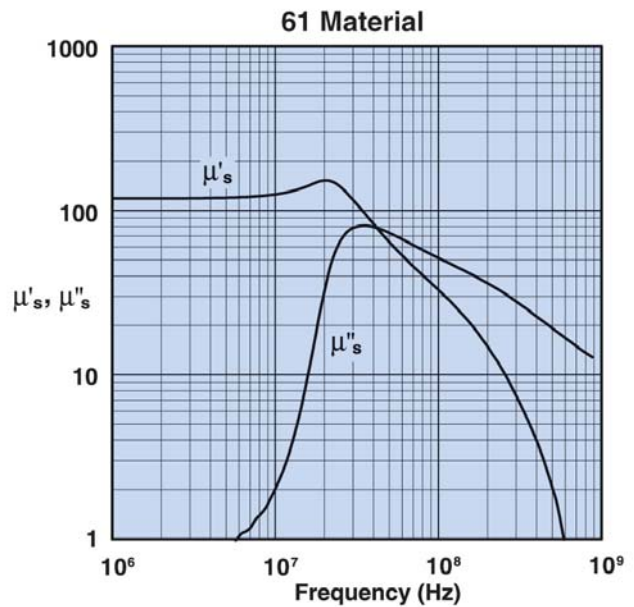

Figure 11 Complex Permeability vs. Frequency Measured on a 17/10/6mm toroid using the HP 4284A and the HP 4291A

Technical Information

The dc bias is more complex. The dc bias will affect both the μ'_s and μ''_s , but this is also influenced by the core geometry, specifically the magnetic path length. Therefore Fair-Rite provides dc bias information based on a dc H field in oersted for many of its suppression components. For all EMI suppression beads and round cable suppression cores listed in the catalog a calculated H value ($H=1.256/I_m$) that is based on a single turn and one Amp direct current is shown. This calculated value of H should be modified if more turns are used or if the current is not 1 A. A 2 Amp current will of course double the value listed for the part. Once the true dc H field is calculated, graphs in Figures 18 through 23 will provide the change in impedance information for the appropriate material, frequency and true H value.

Dc bias curves are included on the Fair-Rite CD-ROM. Also those components for which the magnetic path length cannot easily be calculated the dc bias curves are on the CD-ROM as well. Again, this will provide the designer with a quick evaluation on how the dc bias affects the performance of these components.

73 Material

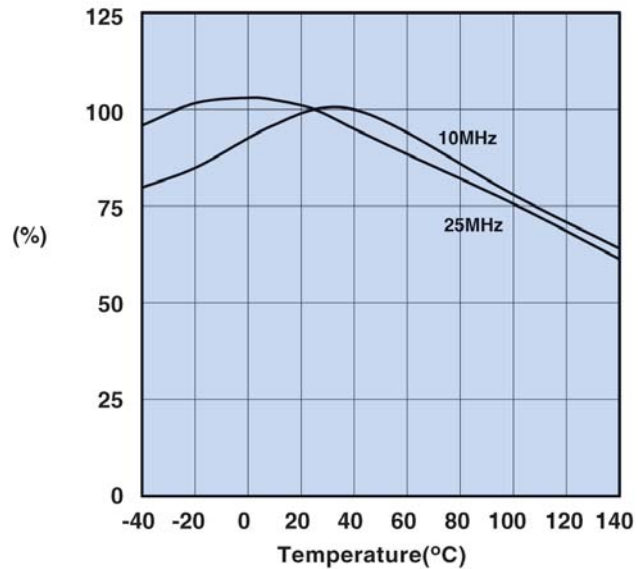

Figure 12 Percent of Original Impedance vs. Temperature Measured on a 2673000301 using the HP4291A.

31 Material

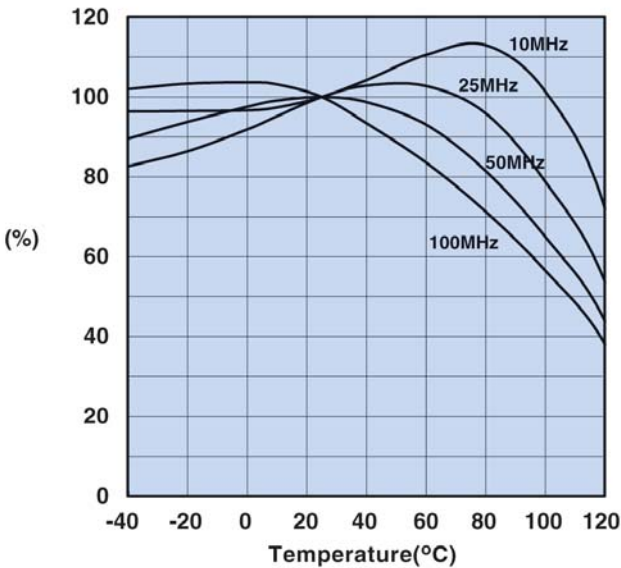

Figure 13 Percent of Original Impedance vs. Temperature Measured on a 2631000301 using the HP4291A.

43 Material

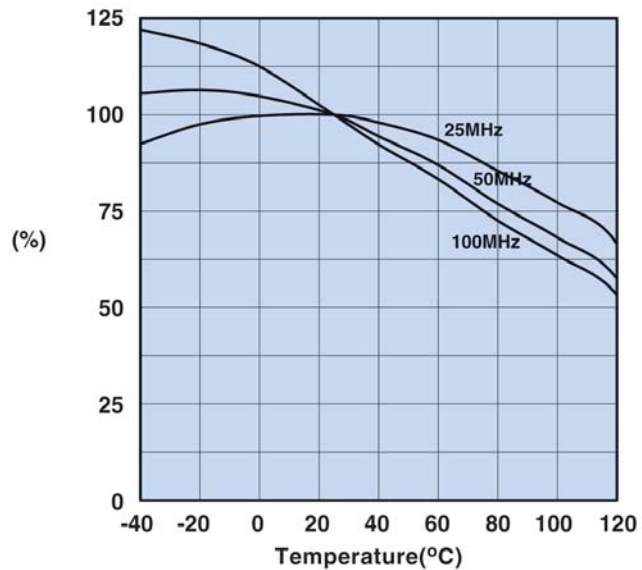

Figure 14 Percent of Original Impedance vs. Temperature Measured on a 2643000301 using the HP4291A.

Technical Information

44 Material

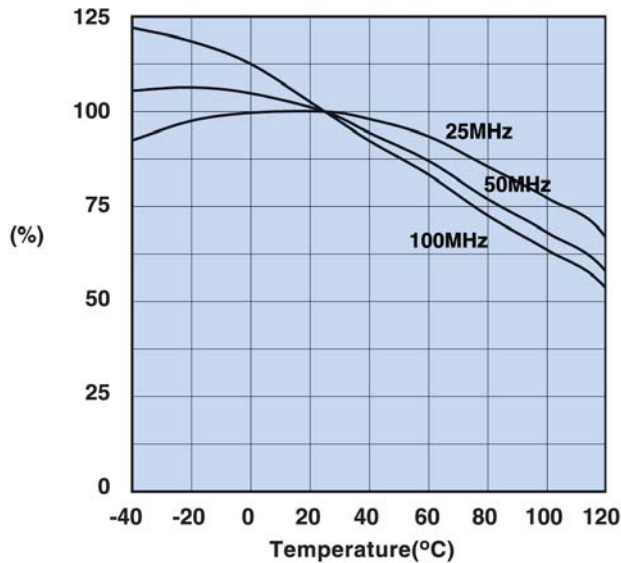

Figure 15 Percent of Original Impedance vs. Temperature Measured on a 2644000301 using the HP4291A.

46 Material

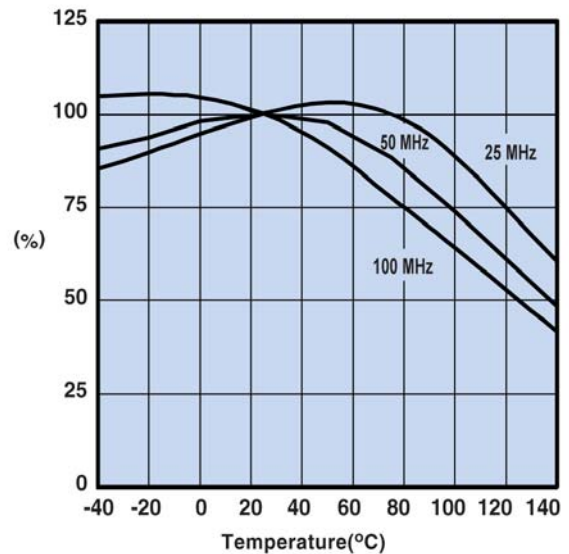

Figure 16 Percent of Original Impedance vs. Temperature Measured on a 2646000301 using the HP4291A.

61 Material

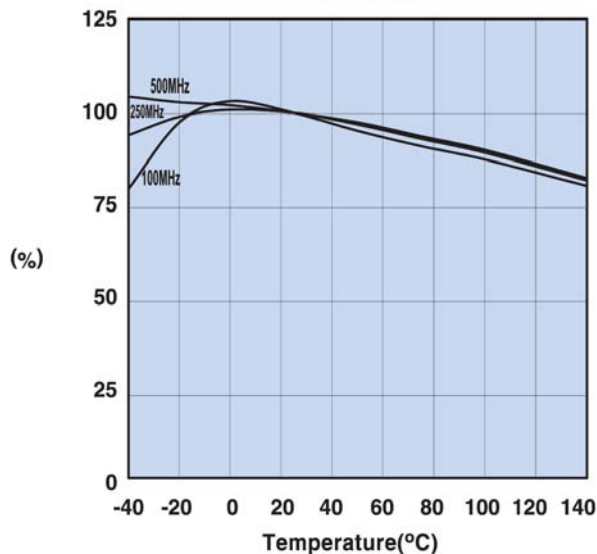

Figure 17 Percent of Original Impedance vs. Temperature Measured on a 2661000301 using the HP4291A.

Secondary Material Parameters

Although μ'_s and μ''_s are the most critical material characteristics for suppression applications, resistivity and Curie temperature are ferrite material parameters that should be considered as well.

The Curie temperature is the transition temperature above which the ferrite loses its magnetic properties. At this temperature the component is no longer performing its intended function. Once the material cools down below this temperature it will again perform as before. For all Fair-Rite materials a minimum Curie temperature is specified.

As mentioned previously, Fair-Rite manufactures three classes of ferrite materials, MnZn, NiZn and MgZn ferrites. The manganese zinc materials have low resistivities whereas the nickel zinc and magnesium zinc materials have high resistivities. For applications that use non-insulated wires or for use as connector suppression plates, a ferrite material with the highest resistivity is recommended. Fair-Rite's 44 material is an improved 43 material by providing both increased resistivity and Curie temperature. Components in the 44 NiZn material are catalog standard parts for connector plates and wound parts such as PC beads and wound beads.

Technical Information

73 Material

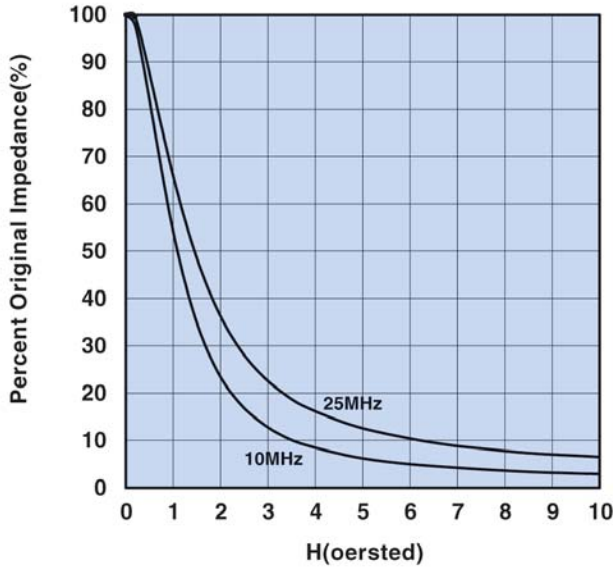

Figure 18 Percent of Original Impedance vs. Magnetic Field Strength. Measured on a 2673000301 using the HP4291A.

31 Material

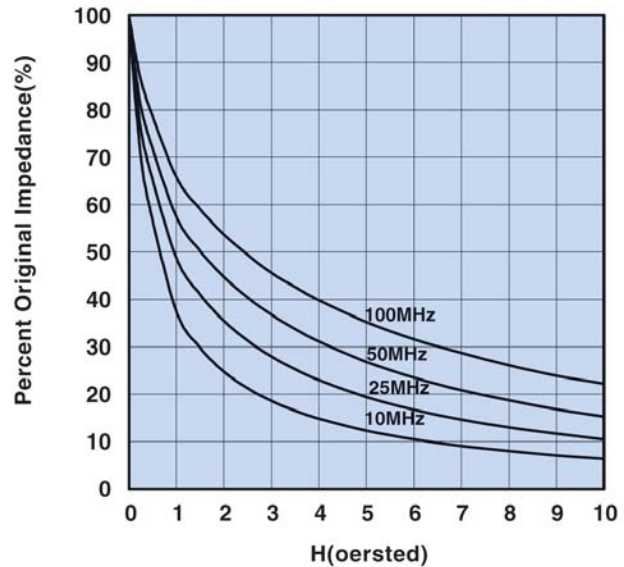

Figure 19 Percent of Original Impedance vs. Magnetic Field Strength. Measured on a 2631000301 using the HP4291A.

43 Material

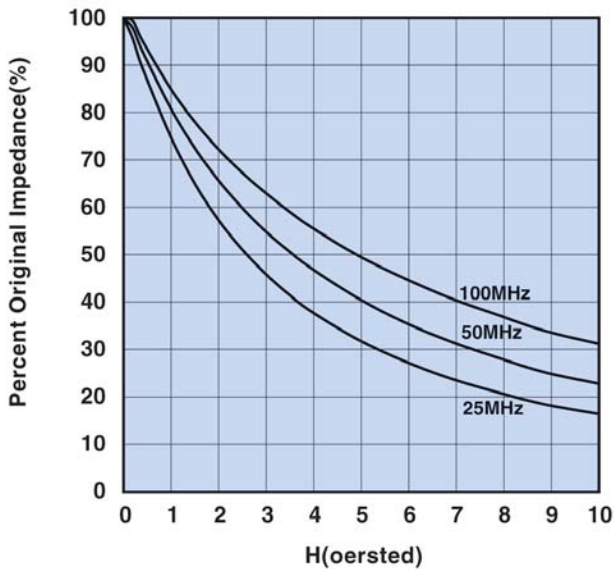

Figure 20 Percent of Original Impedance vs. Magnetic Field Strength. Measured on a 2643000301 using the HP4291A.

44 Material

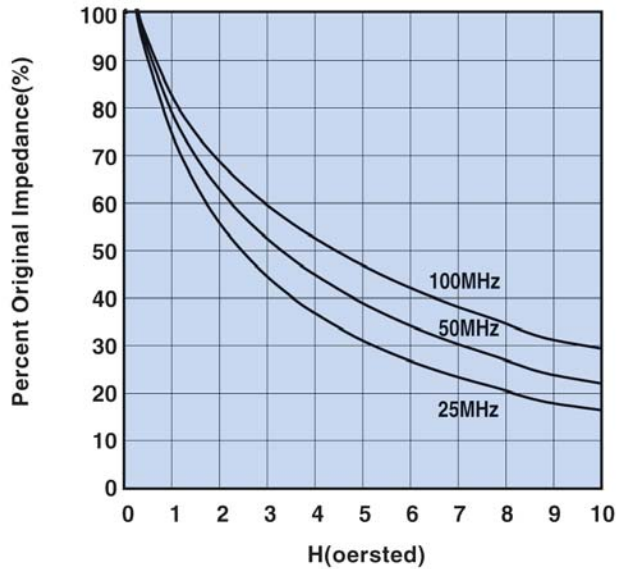

Figure 21 Percent of Original Impedance vs. Magnetic Field Strength. Measured on a 2644000301 using the HP4291A.

Technical Information

46 Material

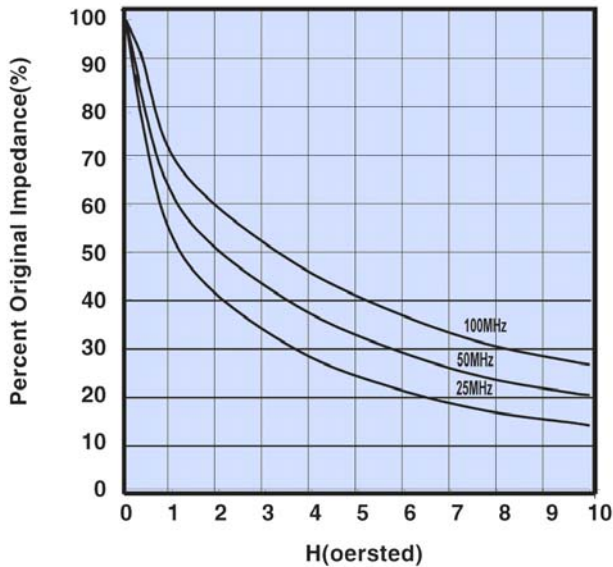

Figure 22 Percent of Original Impedance vs. Magnetic Field Strength. Measured on a 2646000301 using the HP4291A.

61 Material

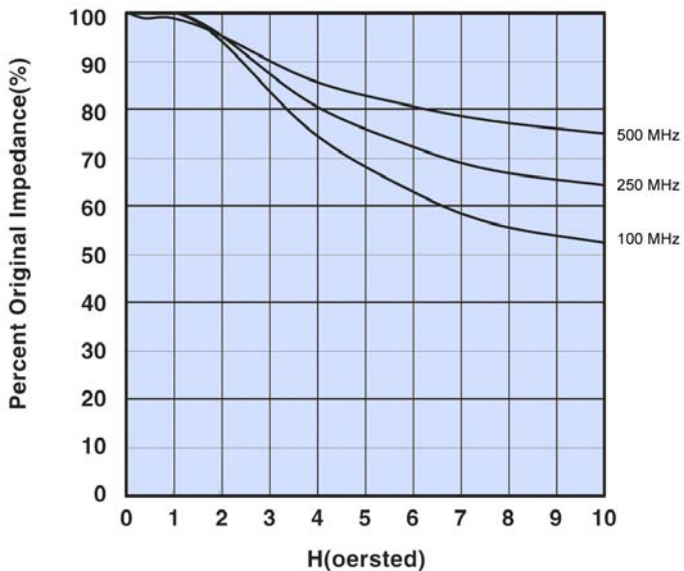

Figure 23 Percent of Original Impedance vs. Magnetic Field Strength. Measured on a 2661000301 using the HP4291A.

Common-Mode Design

If the dc currents are so high that the resulting impedances are not sufficient to suppress the conducted noise, the common-mode approach might solve the problem. As shown in Figure 24, in a common-mode design both current-carrying conductors will pass through the same hole in the core. The dc fields will cancel and the common-mode noise that is picked-up on both lines will be attenuated. It should be pointed out that an EMI signal that is on the line to the load and then returns from the load will not “see” the core and will not be attenuated.

In applications with a large direct current in a single conductor, the solution might be the use of an open magnetic circuit core such as a wound ferrite rod. In automotive designs where the ground is used as the return path, this often is the only option.

When high frequency operating signals, typically above 1 MHz, are susceptible to EMI, the common-mode approach might be used to solve that problem. In this instance common-mode is not used for the current compensation, but rather for the compensation of the high frequency signals. These signal pairs will be not be suppressed, yet any common-mode EMI will be attenuated. The use of round or flat cable cores is a good example of this application of this type of common-mode suppression.

Common-Mode Design

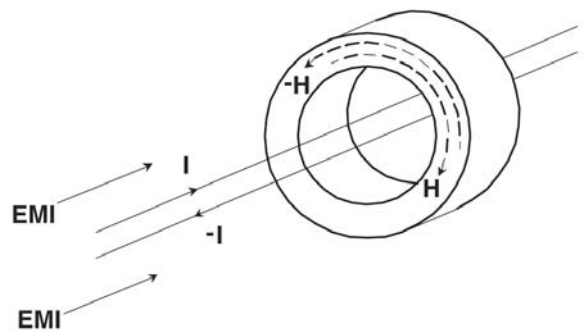

Figure 24

Technical Information

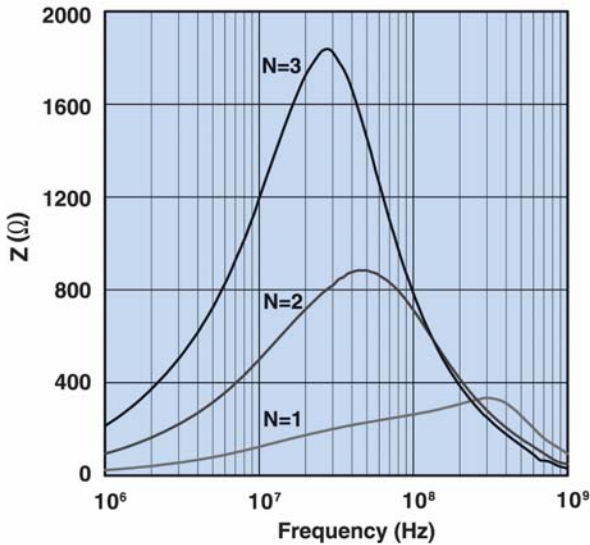

Figure 25 Impedance vs. frequency for a 14/6/28mm cable core in 43 material wound with one, two, and three turns.

Overall the process of selecting a bead or cable core that fits the wire or cable is mainly a mechanical evaluation, but the longer the selected core the higher the impedance for a given volume of ferrite material.

Suppression Materials

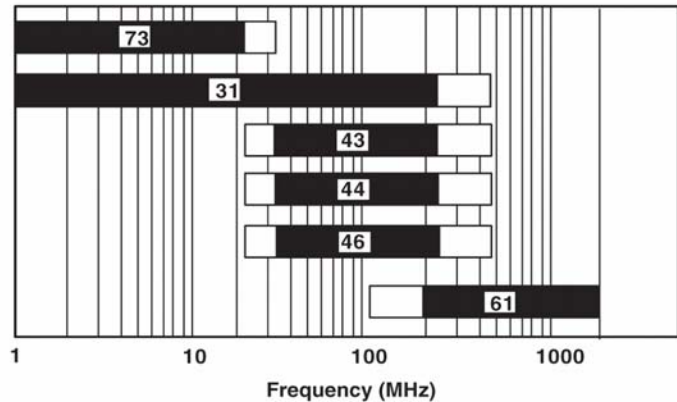

Figure 26 Available Fair-Rite Suppression Materials vs. Frequency

Core Selection

Once the proper ferrite material for a specific suppression application has been decided the required ferrite core is the next step in solving the EMI problem. The core contribution to the impedance is expressed in the formula

$$L_o = \frac{4\pi N^2 10^{-9}}{C_1} \text{ (H)}$$

From this formula it is evident that the impedance is proportional to the square of the number of turns and the core geometry shown by the core factor C_1 . The advantage of the proportionality of N^2 is often overlooked and yet can enhance the overall impedance significantly for a rather minor cost. Figure 25 shows the impedance versus frequency curves for one of Fair-Rite's 43 material cable cores wound with one, two and three turns. By increasing the number of turns the winding capacitance is increased resulting in a shift in the maximum impedance to lower frequencies. If an improvement of the low frequency impedance performance is needed, this increase in turns can be very beneficial for the 43 material applications.

The core geometry most often used in suppression applications is the toroidal core. When the dimensions are in inches, the L_o for the toroidal core shape is $1.17 N^2 H \log_{10} OD/ID 10^{-8}$ (H). Of the three core dimensions OD, ID and H (height), the H is the most significant. This dimension is proportional to the toroidal L_o and hence of the impedance of the core. Doubling H will double the volume and also the impedance. Doubling the core volume by changing the OD and or the ID will only increase the impedance by approximately 40%.

Suppressing Common-Mode Noise

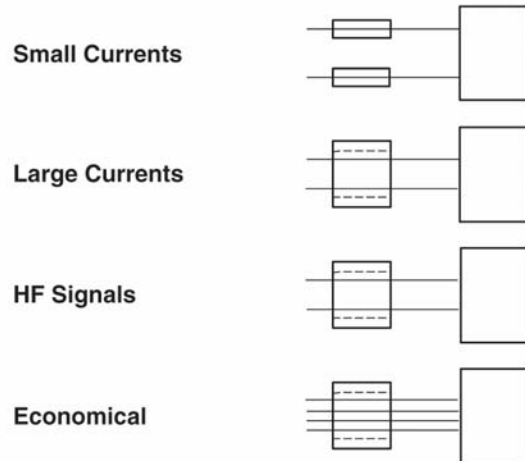

Figure 27

Suppressing Differential-Mode Noise

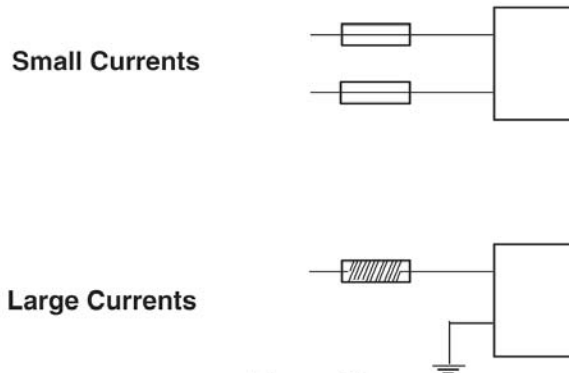

Figure 28

Summary

1. Material Selection

The graph in Figure 26 aids in the initial material selection for suppressing conducted EMI frequencies.

DC bias, core size, operating temperature and resistance requirements might affect this choice.

2. Core Selection

To make a final core selection, the type of EMI, common-mode or differential-mode, will affect the choice of the core configuration.

Figures 27 and 28 provide an overview of the available core shape options for different levels of input currents.

Although the catalog lists hundreds of suppression components, we at Fair-Rite Products Corp. will manufacture parts to fit customer specific applications. Contact one of our representatives or our sales office in Wallkill, NY with your requirements.

Part Number Index

0					
0199000005	67	0446164951	82	2508055007Y0	60
0199000017	72	0446167251	82	2508056007Y0	61
0199000018	67	0446167281	82	2508056007Y3	62
0199000019	68	0446173551	82	2508056007Y6	63
0199000024	68	0446173951	82	2508056007Z0	61
0199000025	69	0446176451	82	2508056017Y0	61
0199000027	69	0461164181	83	2508056017Y2	62
0199000028	70	0461164281	82	2508059007Y0	61
0199000029	70	0461164951	82	2512061017Y0	61
0199000030	70	0461167281	83	2512061027Y0	61
0199000031	71	0461176451	83	2512061027Y0A4	65
0199000032	71	0461178181	82	2512061027Y1	62
0199000033	72	0461178281	82	2512061217Y0	61
0199000036	72	2		2512061217Y0A4	65
0199000038	73	2504021007Y0	60	2512061217Y5	63
0199000039	73	2504021217Y0	60	2512061517Y3	62
0199001401	87	2504023017Y0	60	2512061527Y0	61
0199010301	87	2504026007Y0	60	2512063007Y0	61
0199016051	87	2504026017Y0	60	2512063007Y3	62
0199016551	87	2506030707H0	60	2512063017Y0	61
0431163951	88	2506031007H0	60	2512063017Y0A4	65
0431164051	88	2506031017Y0	60	2512063017Y3	62
0431164181	81	2506031027H0	60	2512065007Y0	61
0431164281	81	2506031027Y0	60	2512065007Y3	62
0431164951	81	2506031217H0	60	2512065007Y6	63
0431167281	81	2506031217Y0	60	2512066007Y0A4	65
0431173551	81	2506031217Y2	62	2512066017Y0	61
0431173951	81	2506031217Z0	60	2512066017Y0A4	65
0431176451	81	2506031517Y0	60	2512066017Y1	62
0431177081	81	2506032217H0	60	2512067007Y0	61
0431178181	81	2506033007Y0	60	2512067007Y3	62
0431178281	81	2506033007Y3	62	2512069007Y0	61
0443163951	88	2506033017Y0	60	2518061017Y0	61
0443164051	88	2506033017Z0	60	2518061017Y6	63
0443164151	81	2506033317H0	60	2518061517Y0	61
0443164251	81	25060336007Y0	60	2518065007Y6	63
0443166651	88	25060336007Y3	62	2518066007Y3	62
0443167251	81	2506036007Z0	60	2518068007Y3	62
0443178181	81	2506036017Y0	60	2518121217Y3	62
0443178281	81	2506038007Y0	60	2518121217Y6	63
0443625006	81	2508051017Y0	61	2518127007Y3	62
0443665806	81	2508051027Y0	61	2631023002	76
0443800506	82	2508051027Y1	62	2631101902	76
0443806406	82	2508051107Y0	60	2631102002	76
0444164181	82	2508051217Y0	61	2631103002	76
0444164281	81	2508051217Y3	62	2631163851	85
0444164951	81	2508051217Y6	63	2631163851	85
0444167281	81	2508051217Z0	61	2631164051	85
0444173551	82	2508051527Y0	61	2631181381	81
0444173951	81	2508051817Y0	61	2631250202	76
0444176451	82	2508052027Y1	62	2631480002	76
0444177081	82	2508052027Z0	61	2631480102	76
0446164151	82	2508053007Y0	60	2631540002	76
0446164181	82	2508053007Y3	62	2631540202	76
0446164251	82	2508053017Y0	61	2631625002	76
0446164281	82	2508053017Y3	62	2631625102	76
		2508053017Z0	61	2631626202	76
				2631626302	76
				2631626402	76
				2631665702	76
				2631801202	76
				2631803802	76
				2631814002	76
				2643000101	37
				2643000201	37
				2643000301	37
				2643000501	37
				2643000701	37
				2643000801	37
				2643001301	37
				2643001501	37
				2643001601	37
				2643002201	37
				2643002402	38
				2643003201	37
				2643004601	37
				2643004701	37
				2643004801	37
				2643005701	37
				2643006302	37
				2643012702	38
				2643013801	37
				2643020501	37
				2643021801	37
				2643022401	37
				2643023002	38
				2643023201	37
				2643023402	37
				2643025601	37
				2643101902	77
				2643102002	77
				2643102402	77
				2643103002	78
				2643163851	85
				2643163951	86
				2643164051	86
				2643164551	85
				2643165151	91
				2643166451	86
				2643166551	86
				2643166651	86
				2643166851	85
				2643167551	86
				2643167751	86
				2643167851	91
				2643168051	86
				2643168251	86
				2643168351	86
				2643168651	85
				2643168751	85
				2643169351	85
				2643169552	85
				2643170251	85
				2643170951	86
				2643171051	85
				2643172551	85
				2643173351	85
				2643173851	85
				2643175451	91
				2643178351	85
				2643178551	85
				2643178651	85
				2643178751	85
				2643180251	85
				2643180351	85
				2643180451	85
				2643180551	86
				2643180651	86
				2643180751	86
				2643180851	85
				2643200101	37
				2643250202	37
				2643250302	37
				2643250402	37
				2643251002	77
				2643300101	37
				2643375002	37
				2643375102	37
				2643480002	77
				2643480102	77
				2643540002	77
				2643540102	77
				2643540202	77
				2643540302	77
				2643540402	77
				2643540702	77
				2643625002	77
				2643625102	77
				2643625202	77
				2643625902	78
				2643626002	78
				2643626102	78
				2643626202	78
				2643626302	77
				2643626402	77
				2643626502	77
				2643665702	77
				2643665802	77
				2643665902	77
				2643800302	77
				2643800502	77
				2643800602	77
				2643801002	78
				2643801102	77
				2643801202	78
				2643801402	77
				2643801502	77
				2643801802	77
				2643801902	77
				2643802702	78
				2643803802	78
				2643804502	78

Fair-Rite Products Corp. PO Box 288, One Commercial Row, Walkill, NY 12589-0288

Part Number Index

2643806402	77	2673000801	36	2743021447	53	2752555576	54	2773044446	52
2643814002	78	2673001601	36	2743037446	53	2752555576	54	2773044447	52
2644181281	82	2673002201	36	2743037446	53	2752555577	54	2773044447	52
2644236001	90	2673002402	36	2743037447	53	2752555577	54	2843000102	48
2644236101	90	2673003201	36	2743037447	53	2761001111	41	2843000202	48
2644236301	90	2673004601	36	2744040446	53	2761001112	41	2843000302	48
2644236401	90	2673004701	36	2744040446	53	2761002111	41	2843001502	48
2644236501	90	2673004801	36	2744040447	53	2761002112	41	2843001802	48
2644236601	90	2673004901	36	2744040447	53	2761004111	41	2843002302	48
2644245701	90	2673012401	36	2744041446	56	2761004112	41	2843002402	48
2644246201	90	2673015301	36	2744041446	56	2761007111	41	2843002702	48
2644246701	90	2673018001	36	2744041447	56	2761007112	41	2843006802	48
2644247001	90	2673021801	36	2744041447	56	2761008111	41	2843009902	48
2644247101	90	2673022401	36	2744044446	53	2761008112	41	2843010302	48
2644373841	90	2673025301	36	2744044446	53	2761009111	41	2843010402	48
2644373941	90	2673028602	36	2744044447	53	2761009112	41	2861000102	49
2644666611	45	2673030101	36	2744044447	53	2761015111	41	2861000202	49
2644777711	45	2673200201	36	2744045446	56	2761015112	41	2861000302	49
2646101902	78	2673901301	36	2744045446	56	2761019446	54	2861001502	49
2646102002	78	2675023002	75	2744045447	56	2761019446	54	2861001702	49
2646102402	78	2675102002	76	2744045447	56	2761019447	54	2861002302	49
2646480002	78	2675540002	75	2744051446	56	2761019447	54	2861002402	49
2646480102	78	2675540202	75	2744051446	56	2761021446	54	2861002702	49
2646540002	78	2675625102	75	2744051447	56	2761021446	54	2861006802	49
2646540202	78	2675626402	76	2744051447	56	2761021447	54	2861010002	49
2646625002	78	2675665702	75	2744065446	56	2761021447	54	2867000102	49
2646625102	78	2675821502	76	2744065446	56	2773001111	39	2867000302	49
2646625202	78	2677006302	91	2744065447	56	2773001112	39	2867001502	49
2646626202	79	2677102402	91	2744065447	56	2773002111	40	2867002302	49
2646626402	78	2743001111	40	2744555566	54	2773002112	40	2867002402	49
2646665702	78	2743001112	40	2744555566	53	2773003111	39	2867002702	49
2646665802	78	2743002111	40	2744555567	53	2773003112	39	2867006802	49
2646803802	79	2743002112	40	2744555567	53	2773004111	40	2873000102	48
2646804502	78	2743003111	40	2744555576	54	2773004112	39	2873000202	48
2661000101	38	2743003112	40	2744555576	53	2773005111	39	2873000302	48
2661000301	38	2743004111	40	2744555577	54	2773005112	39	2873001502	48
2661000701	38	2743004112	40	2744555577	53	2773007111	40	2873001702	48
2661000801	38	2743005111	40	2752041446	57	2773007112	40	2873001802	48
2661021801	38	2743005112	40	2752041446	57	2773008111	40	2873002302	48
2661022401	38	2743007111	40	2752041447	57	2773008112	40	2873002402	48
2661023801	38	2743007112	40	2752041447	57	2773009111	40	2873002702	48
2661102002	79	2743008111	40	2752045446	57	2773009112	40	2873006802	48
2661102402	79	2743008112	40	2752045446	57	2773015111	39	2944666631	45
2661250402	38	2743009111	41	2752045447	57	2773015112	39	2944666631	45
2661375102	38	2743009112	41	2752045447	57	2773019446	52	2944666634	45
2661480002	79	2743012201	41	2752051446	57	2773019446	52	2944666634	46
2661540002	79	2743013211	41	2752051446	57	2773019447	52	2944666651	45
2661540202	79	2743014221	41	2752051447	57	2773019447	52	2944666651	45
2661626402	79	2743015111	40	2752051447	57	2773021446	52	2944666654	45
2661665702	79	2743015112	40	2752065446	57	2773021446	52	2944666654	45
2661666611	45	2743019446	53	2752065446	57	2773021447	52	2944666661	45
2661801902	79	2743019446	53	2752065447	57	2773021447	52	2944666661	45
2673000101	36	2743019447	53	2752065447	57	2773037446	52	2944666671	45
2673000201	36	2743019447	53	2752555566	54	2773037446	52	2944666671	45
2673000301	36	2743021446	53	2752555566	54	2773037447	52	2944666681	45
2673000501	36	2743021446	53	2752555567	54	2773037447	52	2944666681	45
2673000701	36	2743021447	53	2752555567	54	2773044446	52	2944770301	43

Fair-Rite Products Corp. PO Box 288, One Commercial Row, Walkill, NY 12589-0288

Phone: (888) FAIR RITE / (845) 895-2055 • Fax: (888) FERRITE / (845) 895-2629 • Web: www.fair-rite.com
 (888) 324-7748 (888) 337-7483 E-mail: ferrites@fair-rite.com

Part Number Index

2944776101	43	4052098411	93	5698221421		5943006421	106	5967003801	103
2944777721	46	4052111011	93	5695221421		5943007601	106	5967003821	103
2944777721	45	4052155611	93	5678221421	114	5943011101	106	5968000201	102
2944777741	46	4052195211	93	5698221421		5943011121	106	5968000301	102
2944777741	45	4052235211	93	5695221421		5943015901	106	5968001101	102
2944778101	43	4052251111	93	5678261721	115	5943017301	106	5968001801	102
2944778301	43	4061266011	93	5698261721		5943017501	106	5968002701	103
2952776101	43	4061272011	93	5695261721		5943018601	106	5968003801	103
2952778301	43	4061276011	93	5678261721	114	5952003801	105	5968020901	102
2961666631	46	4061287011	93	5698261721		5952020201	104	5968021001	102
2961666631	46	4061375411	93	5695261721		5952020301	104	5975000101	108
2961666634	46	4061378111	93	5678302021	115	5952020401	104	5975000201	108
2961666634	46	4077122011	94	5698302021		5952020501	104	5975000211	109
2961666651	46	4077172011	94	5695302021		5952020601	105	5975000221	109
2961666651	46	4077266011	94	5678302021	114	5952020701	105	5975000301	109
2961666654	46	4077272011	94	5698302021		5952020801	105	5975000321	109
2961666654	46	4077276011	94	5695302021		5961000101	103	5975000501	109
2961666661	46	4077292011	94	5678362321	114	5961000111	103	5975000601	109
2961666661	46	4077296011	94	5698362321		5961000201	103	5975000621	109
2961666671	46	4077312911	94	5695362321		5961000211	103	5975000801	108
2961666671	46	4077374711	94	5678362321	115	5961000221	103	5975001101	109
2961666681	46	4077375211	94	5698362321		5961000301	103	5975001121	109
2961666681	46	4077375411	94	5695362321		5961000321	104	5975001401	109
3		4077484611	94	5943000101	105	5961000501	104	5975001801	109
3061990821	98	4077485111	94	5943000111	105	5961000601	104	5975001821	109
3061990831	98	4078375111	94	5943000201	105	5961000621	104	5975001901	109
3061990841	98	4078377511	94	5943000211	105	5961000801	103	5975002101	108
3061990851	98	4277142009	94	5943000221	105	5961000811	103	5975002701	109
3061990861	98	4277242409	94	5943000301	105	5961000811	103	5975002701	109
3061990871	98	4277352509	94	5943000321	105	5961001001	104	5975003801	109
3061990881	98	4277353509	94	5943000501	105	5961001021	104	5975003821	109
3061990891	98	4278282509	94	5943000521	105	5961001101	104	5975004901	109
3061990901	98	4278453509	94	5943000601	105	5961001121	104	5975004921	109
3061990911	98	5		5943000621	105	5961001201	104	5975005101	109
3067990821	97	5678090621	115	5943000801	105	5961001221	104	5975006401	109
3067990831	97	5698090621		5943000901	105	5961001701	104	5975007601	109
3067990841	97	5695090621		5943000911	105	5961001721	104	5975007621	109
3067990851	97	5678090621	114	5943001001	106	5961001801	104	5975011101	109
3067990861	97	5698090621		5943001021	106	5961001821	104	5975011121	109
3067990871	97	5695090621		5943001101	105	5961001901	104	5975021921	109
3067990881	97	5678110821	114	5943001121	105	5961001921	104	5975022021	109
3078990821	98	5698110821		5943001201	106	5961002701	104	5976000101	110
3078990831	98	5695110821		5943001301	106	5961002721	104	5976000201	110
3078990841	98	5678110821	115	5943001401	106	5961003801	104	5976000211	110
3078990851	98	5698110821		5943001421	106	5961003821	104	5976000221	110
3078990851	98	5695110821		5943001601	106	5961004901	104	5976000801	110
3078990861	98	5678140921	114	5943001701	106	5961004921	104	5976011121	110
3078990871	98	5698140921		5943001801	105	5967000101	103	5976022021	110
3078990881	98	5695140921		5943001821	106	5967000201	103	5976022121	110
3078990891	98	5678140921	115	5943001901	105	5967000301	103	5977000101	106
3078990901	98	5698140921		5943001921	105	5967000601	103	5977000201	106
3078990911	98	5695140921		5943002701	106	5967001001	103	5977000211	106
4		5678181221	115	5943002721	106	5967001101	103	5977000221	107
4033122011	94	5698181221		5943003801	106	5967001201	103	5977000301	107
4033129021	94	5695181221		5943003821	106	5967001701	103	5977000321	107
4033266011	94	5678181221	114	5943004901	105	5967001801	103	5977000501	107
4033276011	94	5698181221		5943004921	105	5967001901	103	5977000601	107
4052077111	93	5695181221		5943005101	105	5967002701	103	5977000621	107
		5678221421	115	5943006401	106				

Fair-Rite Products Corp. PO Box 288, One Commercial Row, Wallkill, NY 12589-0288

Part Number Index

5977001001	107	6278140121	116	6598200121		7898400121		8998303021	
5977001021	107	6298140121		6595200121		7895400121		8995303021	
5977001101	107	6295140121		6678211621	119	7878400221	113	9	
5977001121	107	6278180121	117	6698211621		7898400221		9077002002	129
5977001201	107	6298180121		6695211621		7895400221		9077002002	128
5977001221	107	6295180121		6678211621	118	7878400221	112	9077024002	128
5977001301	107	6278180121	116	6698211621		7898400221		9077024002	129
5977001321	107	6298180121		6695211621		7895400221		9077025002	129
5977001401	107	6295180121		6678212021	119	7878400321	113	9077025002	128
5977001421	107	6278230121	117	6698212021		7898400321		9077026002	129
5977001601	107	6298230121		6695212021		7895400321		9077026002	128
5977001621	107	6295230121		6678212021	118	7878400321	112	9277002002	128
5977001701	107	6278230121	116	6698212021		7898400321		9277002002	129
5977001721	108	6298230121		6695212021		7895400321		9277008002	128
5977001801	107	6295230121		6678272021	119	7878400421	113	9277008002	129
5977001821	107	6278280121	117	6698272021		7898400421		9277008002	129
5977001901	107	6298280121		6695272021		7895400421		9277010002	128
5977001921	107	6295280121		6678272021	118	7878400421	112	9277010002	129
5977002701	108	6278280121	116	6698272021		7898400421		9277012002	129
5977002721	108	6298280121		6695272021		7895400421		9277012002	128
5977003801	108	6295280121		6678272521	118	7878400721	113	9277023002	129
5977003821	108	6278370121	116	6698272521		7898400721		9277023002	128
5977004901	107	6298370121		6695272521		7895400721		9277024002	128
5977005101	107	6295370121		6678272521	119	7878400721	112	9277024002	129
5977006401	107	6278370121	117	6698272521		7898400721		9478101002	120
5977007601	107	6298370121		6695272521		7895400721		9498101002	
5977007601	107	6295370121		6678322121	119	8		9478101002	121
5977011101	108	6278420121	117	6698322121		8978101021	122	9498101002	
5977011121	108	6298420121		6695322121		8998101021		9478102002	120
5978001201	107	6295420121		6678322121	118	8995101021		9478102002	121
5978001221	107	6278420121	116	6698322121		8978101021	123	9478102002	121
5978001701	108	6298420121		6695322121		8998101021		9498102002	
5978001721	108	6295420121		6678323121	119	8995101021		9478103002	121
5978002101	106	6578070121	131	6698323121		8978121221	123	9478103002	121
5978002701	108	6598070121		6695323121		8998121221		9498103002	
5978002721	108	6595070121		6678323121	118	8995121221		9495103002	
5978003801	108	6578070121	130	6698323121		8978121221	122	9478103002	120
5978003821	108	6598070121		6695323121		8998121221		9498103002	
5978007601	107	6595070121		6678353621	118	8995121221		9478104002	120
5978007621	107	6578100121	131	6698353621		8978151521	122	9478104002	121
5978008001	108	6598100121		6695353621		8998151521		9498104002	
5978011101	108	6595100121		6678353621	119	8995151521		9478104002	121
5978014001	108	6578100121	130	6698353621		8978151521	123	9478104002	121
5978015901	108	6598100121		6695353621		8998151521		9478105002	121
5978017301	108	6595100121		6678404121	119	8995151521		9498105002	
5978017321	108	6578130121	131	6698404121		8978202021	122	9478105002	120
5978018601	108	6598130121		6695404121		8998202021		9498105002	
5978018701	108	6595130121		6678404121	118	8995202021		9478110002	121
5978018721	108	6578130121	130	6698404121		8978202021	123	9498110002	
		6598130121		6695404121		8998202021		9495110002	
		6595130121		6678505021	119	8995202021		9478110002	120
6		6578170121	131	6698505021		8978252521	122	9478110002	121
6278110121	117	6598170121		6695505021		8998252521		9498110002	
6298110121		6578170121	130	6678505021	118	8995252521		9495110002	
6295110121		6598170121		6698505021		8978252521	123	9478111002	121
6278110121	116	6595170121		6695505021		8998252521		9498111002	
6298110121		6578200121	131	7		8995252521		9495111002	
6295110121		6598200121		7878400121	112	8978303021	122	9478111002	120
6278140121	117	6598200121		7898400121		8998303021		9498111002	
6298140121		6595200121		7895400121		8995303021		9478112002	121
6278140121	117	6578200121	130	7878400121	113	8978303021	123	9498112002	
6298140121									

Fair-Rite Products Corp. PO Box 288, One Commercial Row, Wallkill, NY 12589-0288

Phone: (888) FAIR RITE / (845) 895-2055 • Fax: (888) FERRITE / (845) 895-2629 • Web: www.fair-rite.com
 (888) 324-7748 (888) 337-7483 E -mail: ferrites@fair-rite.com

Part Number Index

9495112002		9495207002		9578404602	127	9677282009	100
9478112002	120	9578100502	112	9598404602		9677282009	101
9498112002		9598100502		9595404602		9677282509	101
9495112002		9595100502		9578404602	126	9677282509	100
9478114002	121	9578100502	113	9598404602		9677352509	101
9498114002		9598100502		9595404602		9677352509	100
9478114002	120	9595100502		9578424402	127	9677353509	100
9498114002		9578110502	112	9598424402		9677353509	101
9478115002	120	9598110502		9595424402		9677453509	100
9498115002		9595110502		9578424402	126	9677453509	101
9478115002	121	9578110502	113	9598424402		9843000104	100
9498115002		9598110502		9595424402		9843000104	100
9478116002	120	9595110502		9578444502	125	9877000104	101
9498116002		9578150602	112	9598444502		9877000104	100
9478116002	121	9598150602		9595444502		9877000204	101
9498116002		9578150602	113	9598444502	124	9877000204	100
9478117002	121	9598150602		9595444502			
9498117002		9578150602	113	9578494902	125		
9478117002	120	9598150602		9598494902			
9498117002		9595150602		9595494902			
9478201002	113	9578261802	127	9578494902	124		
9498201002		9598261802		9598494902			
9495201002		9595261802		9595494902			
9478201002	112	9578261802	126	9578495402	127		
9498201002		9598261802		9598495402			
9495201002		9595261802		9595495402			
9478202002	113	9578282802	127	9578495402	126		
9498202002		9598282802		9598495402			
9495202002		9595282802		9595495402			
9478202002	112	9578282802	126	9578545402	124		
9498202002		9598282802		9598545402			
9495202002		9595282802		9595545402			
9478203002	113	9578283402	126	9578545402	125		
9498203002		9598283402		9598545402			
9495203002		9595283402		9595545402			
9478203002	112	9578283402	127	9578606002	124		
9498203002		9598283402		9598606002			
9495203002		9595283402		9595606002			
9478204002	113	9578293202	124	9578606002	125		
9498204002		9598293202		9598606002			
9495204002		9595293202		9595606002			
9478204002	112	9578293202	125	9643001015	100		
9498204002		9598293202		9643001015	100		
9495204002		9595293202		9643001165	100		
9478205002	113	9578343502	124	9643001165	100		
9498205002		9598343502		9677001015	100		
9495205002		9595343502		9677001015	101		
9478205002	112	9578343502	125	9677001165	101		
9498205002		9598343502		9677001165	100		
9495205002		9595343502		9677142009	101		
9478206002	112	9578354202	126	9677142009	100		
9498206002		9598354202		9677182009	101		
9495206002		9595354202		9677182009	100		
9478206002	113	9578354202	127	9677182009	100		
9498206002		9598354202		9677182209	100		
9495206002		9595354202		9677182209	101		
9478207002	112	9578394002	124	9677242009	101		
9498207002		9598394002		9677242009	100		
9495207002		9595394002		9677242409	101		
9478207002	113	9578394002	125	9677242409	100		
9498207002		9598394002					
9495207002		9595394002					

Fair-Rite Products Corp. PO Box 288, One Commercial Row, Wallkill, NY 12589-0288

For Your Notes

**Visit our website at:
www.fair-rite.com**

Fair-Rite Products Corp. PO Box 288, One Commercial Row, Wallkill, NY 12589-0288

Phone: (888) FAIR RITE / (845) 895-2055 • Fax: (888) FERRITE / (845) 895-2629 • Web: www.fair-rite.com
(888) 324-7748 (888) 337-7483 E-mail: ferrites@fair-rite.com

For Your Notes

Visit our website at:
www.fair-rite.com

Fair-Rite Products Corp. PO Box 288, One Commercial Row, Walkill, NY 12589-0288

160 Phone: (888) FAIR RITE / (845) 895-2055 • Fax: (888) FERRITE / (845) 895-2629 • Web: www.fair-rite.com
(888) 324-7748 (888) 337-7483 E-mail: ferrites@fair-rite.com