

envelope \varnothing 15,5mm in final assembled state

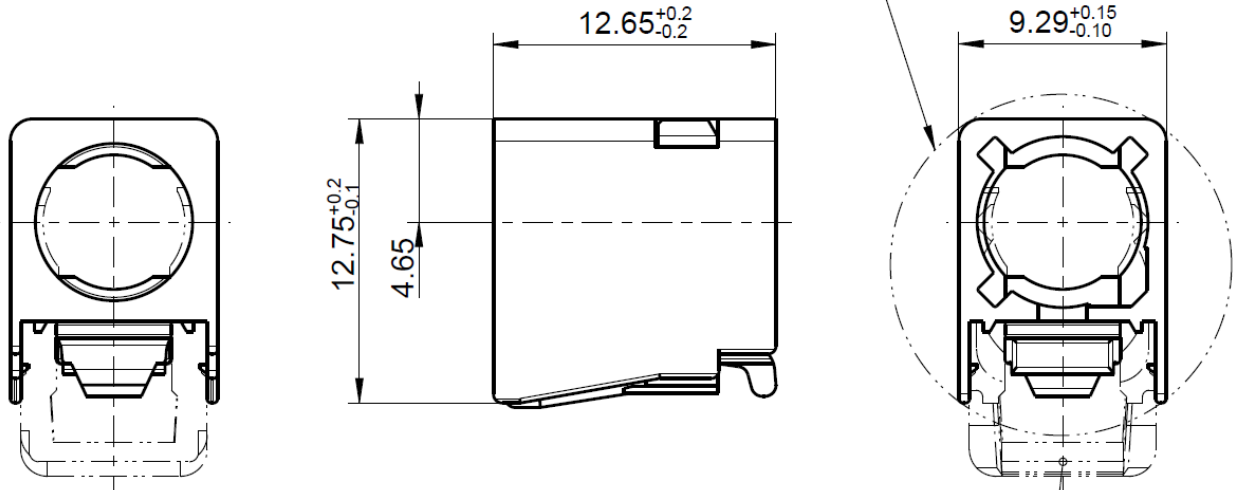

Kabelabgang 360°, frei drehbar
 cable junction 360°, free turnable

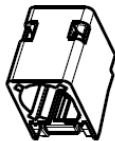

secondary-locking, in delivery condition
 (pre assembled position)

All dimensions are in mm; tolerances according to ISO 2768 m-H
 Y = Part number has to be accomplished by codification

Interface

According to DIN 72594-1

Material

Connector parts

Housing	POM
Secondary Lock	POM

Mechanical data

Mating cycles	≥ 25
Retention force latch	≥ 110 N
Retention force primary lock	≥ 80 N
Retention force secondary lock	≥ 60 N
Coding efficiency	≥ 40 N

Environmental data

Temperature range	-40°C to +105°C
Thermal shock	DIN 72594-2 clause 8.2
Temperature and humidity	DIN 72594-2 clause 8.3
Vibration and mechanical shock	DIN 72594-2 clause 8.1
Dry heat	DIN 72594-2 clause 8.4
RoHS	compliant

Application

Applicable e.g. for following connectors: 59K25A-1xxA4*
 59K25C-1xxA4*
 59K25H-1xxA4*
 59K2DV-1xxA4* ^(e)















^{*)} -xx for all available cable variations

Packing

Standard 2500 pcs in box ^(f)
 2500 pcs in reusable container
 Weight 0.91 g/pce

Coding

Part Number has to be accomplished by codification

Coding	Color	RAL	Part-Number
 A	black	sim. 9005	59Z006-T00-A
 B	white	sim. 9001	59Z006-T00-B
 C	blue	sim. 5005	59Z006-T00-C
 D	bordeauxviolet	sim. 4004	59Z006-T00-D
 E	green	sim. 6002	59Z006-T00-E
 F	brown	sim. 8011	59Z006-T00-F
 G	grey	sim. 7031	59Z006-T00-G
 H	violet	sim. 4003	59Z006-T00-H
 I	beige	sim. 1001	59Z006-T00-I
 K	curry	sim. 1027	59Z006-T00-K
 L	Carmine red	sim. 3002	59Z006-T00-L
 M	pastel orange	sim. 2003	59Z006-T00-M
 N	pastel green	sim. 6019	59Z006-T00-N
 Z	waterblue	sim. 5021	59Z006-T00-Z