

cavity marking  
view from the bottom

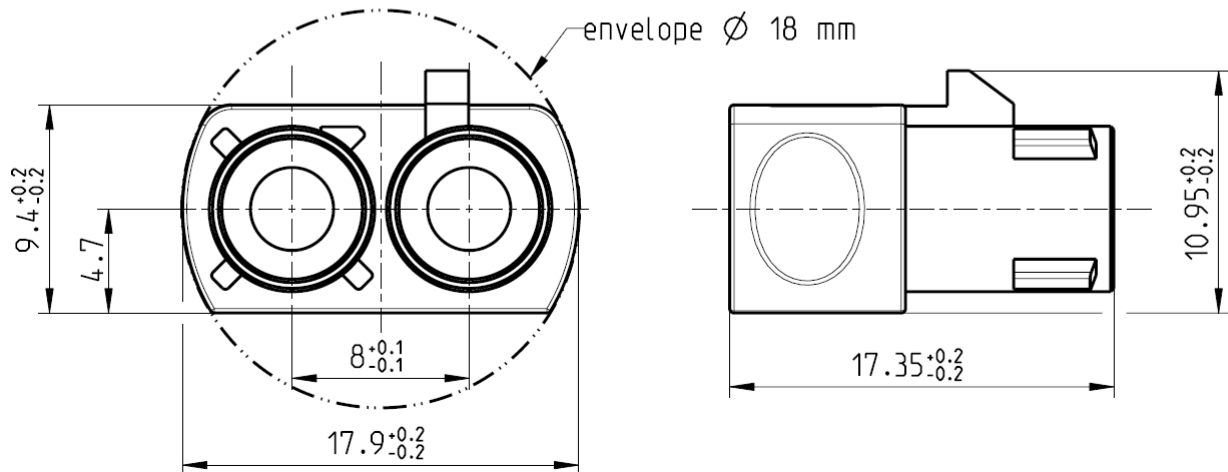

All dimensions are in mm; tolerances according to ISO 2768 m-H  
Y = Part number has to be accomplished by codification

**Interface**

According to DIN 72594-1, USCAR 17

**Material and plating**

**Connector parts**  
Housing

**Material**  
PBT GF23

**Mechanical data**

Mating cycles ≥ 25  
Retention force latch ≥ 110 N  
Retention force primary lock ≥ 110 N  
Coding efficiency ≥ 40 N

Dieses Dokument ist urheberrechtlich geschützt • This document is protected by copyright • Rosenberger Hochfrequenztechnik GmbH & Co. KG

RF\_35/05.10/6.0

FAKRA - HF PLASTIC HOUSING  
DOUBLE 8MM

**59Z065-000-Y**

**Environmental data**

Temperature range -40° C to +105° C  
 Thermal shock DIN 72594-2 clause 8.2  
 Temperature and humidity DIN 72594-2 clause 8.3  
 Vibration and mechanical shock DIN 72594-2 clause 8.1  
 Dry heat DIN 72594-2 clause 8.4  
 RoHS compliant

**Application**

Applicable e.g. for following connectors: 59S10E-1xx \*; 59S10L-1xx \*; 59S10O-1xx \*; 59S16A-1xx \*







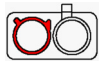

\*-xx for all available cable variations

**Packing**

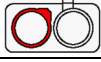
Standard 1500 pcs in reusable container  
 500 pcs in box  
 Weight 1.12 g/pce (d)

**Coding**

Part Number has to be accomplished by codification

Coding	Color	RAL	Part-Number
 A	black	sim. 9005	59Z065-000_A
 B	white	sim. 9001	59Z065-000_B
 C	blue	sim. 5005	59Z065-000_C
 D	bordeauxviolet	sim. 4004	59Z065-000_D
 E	green	sim. 6002	59Z065-000_E
 F	brown	sim. 8011	59Z065-000_F
 G	grey	sim. 7031	59Z065-000_G
 H	violet	sim. 4003	59Z065-000_H
 I	beige	sim. 1001	59Z065-000_I
 K	curry	sim. 1027	59Z065-000_K
 Z	waterblue	sim. 5021	59Z065-000_Z

(e)

(e)

Dieses Dokument ist urheberrechtlich geschützt • This document is protected by copyright • Rosenberger Hochfrequenztechnik GmbH & Co. KG

RF\_35/05.10/6.0