

FAKRA -  
HF

PLASTIC HOUSING

59Z073-001-Y

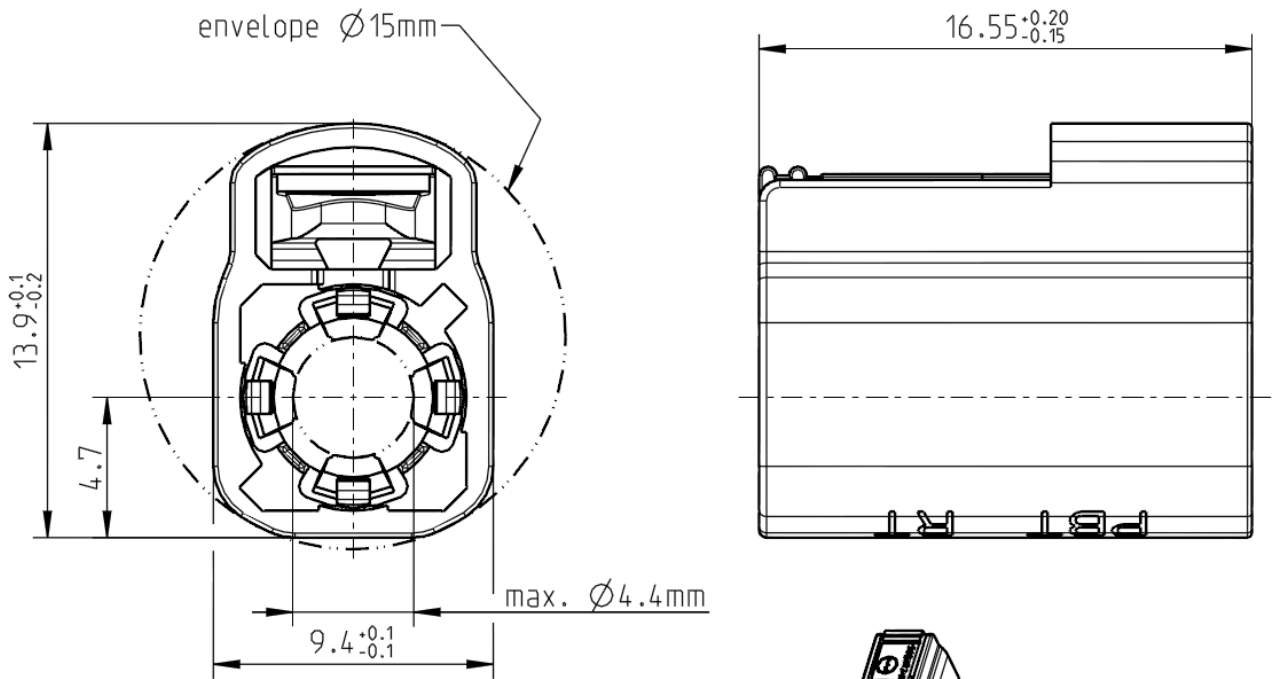

All dimensions are in mm; tolerances according to ISO 2768 m-H  
Y = Part number has to be accomplished by codification

**Interface and coding**

According to

DIN 72594-1, USCAR 17

**Material and plating**

**Connector parts**

Housing

**Material**

PBT-I-GF23



**Mechanical data**

Mating cycles	≥ 25
Retention force latch	≥ 110 N
Retention force primary lock	≥ 110 N
Coding efficiency	≥ 40 N

**Environmental data**

Temperature range	-40°C to +105°C
Thermal shock	DIN 72594-2 clause 8.2
Temperature and humidity	DIN 72594-2 clause 8.3
Vibration and mechanical shock	DIN 72594-2 clause 8.1
Dry heat	DIN 72594-2 clause 8.4
RoHS	(g) compliant

Dieses Dokument ist urheberrechtlich geschützt • This document is protected by copyright • Rosenberger Hochfrequenztechnik GmbH & Co. KG

RF\_35/09.14/6.2

# Technical Data Sheet

# Rosenberger

FAKRA -  
HF

PLASTIC HOUSING

**59Z073-001-Y**

## Application

Applicable e.g. for following connectors: 59K13O-1xx\*; 59K16A-1xx\*; 59K16B-1xx\*; 59K17O-1xx\* f















\* -xx for all available cable variations

## Packing

Standard 500 pcs in box, 2000 pcs in reusable container g  
Weight 1.23 g/pce

## Coding

Part Number has to be accomplished by codification

Coding	Color	RAL	Part-Number	
	A	black	sim. 9005	59Z073-001_A
	B	white	sim. 9001	59Z073-001_B
	C	blue	sim. 5005	59Z073-001_C
	D	bordeauxviolet	sim. 4004	59Z073-001_D
	E	green	sim. 6002	59Z073-001_E
	F	brown	sim. 8011	59Z073-001_F
	G	grey	sim. 7031	59Z073-001_G
	H	violet	sim. 4003	59Z073-001_H
	I	beige	sim. 1001	59Z073-001_I
	K	curry	sim. 1027	59Z073-001_K
	L	Carmine red	sim. 3002	59Z073-001_L
	M	pastel orange	sim. 2003	59Z073-001_M
	N	pastel green	sim. 6019	59Z073-001_N
	Z	waterblue	sim. 5021	59Z073-001_Z

## Change History

Rev.	Date	Change
f00	19.08.16	- Application for following connector added:59K16B-1xx*
g00	16.07.18	- Added "2000 pcs in reusable container" to standard packing - From PBT-GF23 to PBT-I-GF23 - From 2002/95/EC (RoHS) to RoHS

While the information has been carefully compiled to the best of our knowledge, nothing is intended as representation or warranty on our part and no statement herein shall be construed as recommendation to infringe existing patents. In the effort to improve our products, we reserve the right to make changes judged to be necessary.

Draft	Date	Approved	Date	Rev	Engineering change number	Name	Date
D. Oberholler	21.03.06	P. Blafeld	17.07.18	g00	18-1226	C. Ostermaier	17.07.18

Rosenberger Hochfrequenztechnik GmbH & Co. KG  
P.O.Box 1260 D-84526 Tittmoning Germany  
[www.rosenberger.de](http://www.rosenberger.de)

Tel. : +49 8684 18-0  
Email : [info@rosenberger.de](mailto:info@rosenberger.de)

Page  
2 / 2