

secondary lock in pre-position delivered

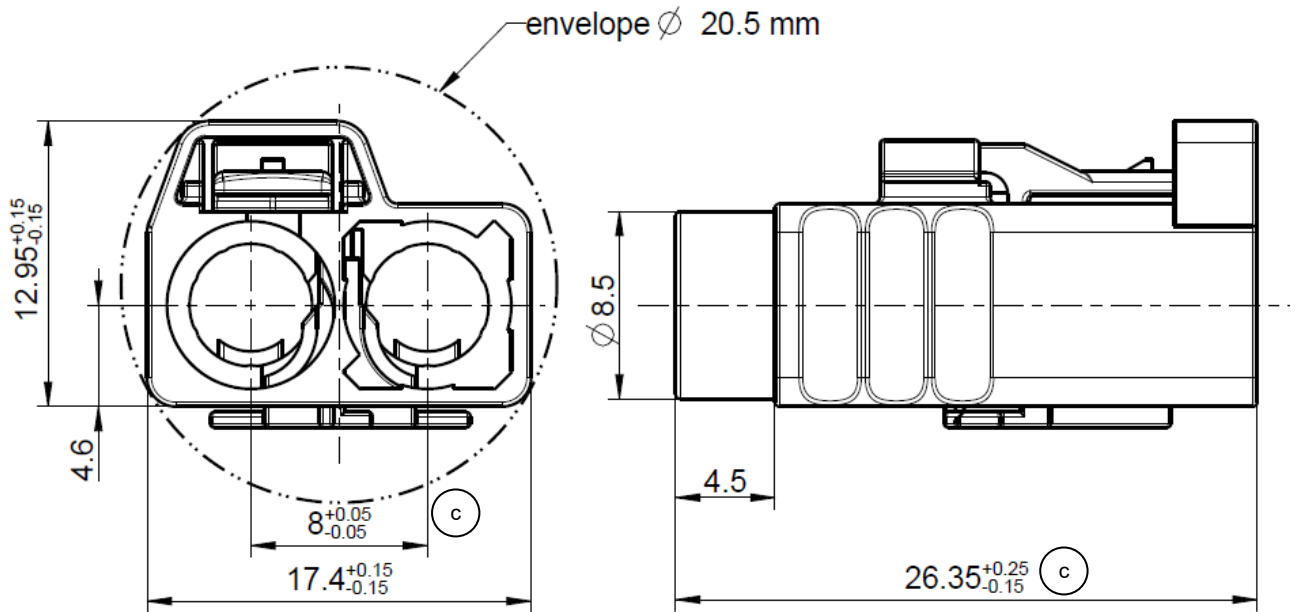
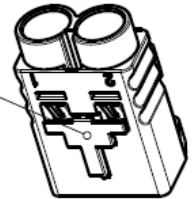

All dimensions are in mm; tolerances according to ISO 2768 m-H
 Y = Part number has to be accomplished by codification

Interface

According to DIN 72594-1

Material

Housing PBT-GF10 (b)
 Secondary Lock PBT-GF10

Mechanical data

Mating cycles ≥ 25
 Retention force latch ≥ 110 N
 Retention force primary lock ≥ 80 N
 Retention force secondary lock ≥ 60 N
 Coding efficiency ≥ 40 N

Dieses Dokument ist urheberrechtlich geschützt • This document is protected by copyright • Rosenberger Hochfrequenztechnik GmbH & Co. KG

RF_35/05.10/6.2

Environmental data

| | |
|--------------------------------|------------------------|
| Temperature range | -40°C to +105°C |
| Thermal shock | DIN 72594-2 clause 6.2 |
| Temperature and humidity | DIN 72594-2 clause 6.3 |
| Vibration and mechanical shock | DIN 72594-2 clause 6.1 |
| Dry heat | DIN 72594-2 clause 6.4 |
| RoHS | compliant |

Application

Applicable e.g. for following connectors: 59K130-1xx*¹⁾, 59K13D-1xx*¹⁾, 59K13F-1xx*¹⁾, 59K16A-1xx*¹⁾, 59K16B-1xx*¹⁾















^{*1)} -xx for all available cable variations
-xxx

Packing

Standard 500 pcs in box, 750 pcs in reusable container (b)
Weight 2.55 g/pce

Coding

Part Number has to be accomplished by codification

| Coding | Color | RAL | Part-Number |
|---|----------------|-----------|-----------------------------|
|  A | black | sim. 9005 | 59Z115-000-A |
|  B | white | sim. 9001 | 59Z115-000-B |
|  C | blue | sim. 5005 | 59Z115-000-C |
|  D | bordeauxviolet | sim. 4004 | 59Z115-000-D |
|  E | green | sim. 6002 | 59Z115-000-E |
|  F | brown | sim. 8011 | 59Z115-000-F |
|  G | grey | sim. 7031 | 59Z115-000-G |
|  H | violet | sim. 4003 | 59Z115-000-H |
|  I | beige | sim. 1001 | 59Z115-000-I |
|  K | curry | sim. 1027 | 59Z115-000-K |
|  L | carmine red | sim. 3002 | 59Z115-000-L* ²⁾ |
|  M | pastel orange | sim. 2003 | 59Z115-000-M* ²⁾ |
|  N | pastel green | sim. 6019 | 59Z115-000-N* ²⁾ |
|  Z | waterblue | sim. 5021 | 59Z115-000-Z |
| | traffic purple | sim. 4006 | secondary lock |

*²⁾ available on request