

secondary lock in pre-position delivered

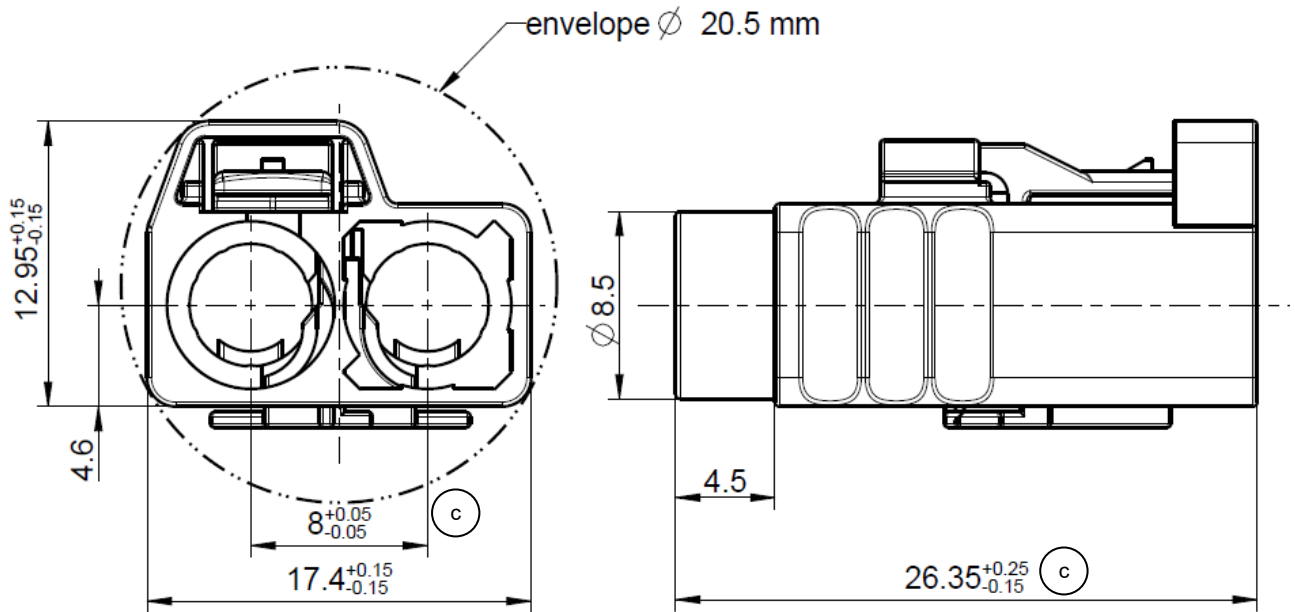
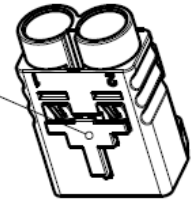

All dimensions are in mm; tolerances according to ISO 2768 m-H
 Y = Part number has to be accomplished by codification

Interface

According to DIN 72594-1

Material

Housing PBT-GF10 (b)
 Secondary Lock PBT-GF10

Mechanical data

Mating cycles ≥ 25
 Retention force latch ≥ 110 N
 Retention force primary lock ≥ 80 N
 Retention force secondary lock ≥ 60 N
 Coding efficiency ≥ 40 N

Dieses Dokument ist urheberrechtlich geschützt • This document is protected by copyright • Rosenberger Hochfrequenztechnik GmbH & Co. KG

RF_35/05.10/6.2

Environmental data

Temperature range	-40°C to +105°C
Thermal shock	DIN 72594-2 clause 6.2
Temperature and humidity	DIN 72594-2 clause 6.3
Vibration and mechanical shock	DIN 72594-2 clause 6.1
Dry heat	DIN 72594-2 clause 6.4
RoHS	compliant

Application

Applicable e.g. for following connectors: 59K130-1xx*¹⁾, 59K13D-1xx*¹⁾, 59K13F-1xx*¹⁾, 59K16A-1xx*¹⁾, 59K16B-1xx*¹⁾















^{*1)} -xx for all available cable variations
-xxx

Packing

Standard 500 pcs in box, 750 pcs in reusable container (b)
Weight 2.55 g/pce

Coding

Part Number has to be accomplished by codification

Coding	Color	RAL	Part-Number
 A	black	sim. 9005	59Z115-000-A
 B	white	sim. 9001	59Z115-000-B
 C	blue	sim. 5005	59Z115-000-C
 D	bordeauxviolet	sim. 4004	59Z115-000-D
 E	green	sim. 6002	59Z115-000-E
 F	brown	sim. 8011	59Z115-000-F
 G	grey	sim. 7031	59Z115-000-G
 H	violet	sim. 4003	59Z115-000-H
 I	beige	sim. 1001	59Z115-000-I
 K	curry	sim. 1027	59Z115-000-K
 L	carmine red	sim. 3002	59Z115-000-L* ²⁾
 M	pastel orange	sim. 2003	59Z115-000-M* ²⁾
 N	pastel green	sim. 6019	59Z115-000-N* ²⁾
 Z	waterblue	sim. 5021	59Z115-000-Z
	traffic purple	sim. 4006	secondary lock

*²⁾ available on request

Dieses Dokument ist urheberrechtlich geschützt • This document is protected by copyright • Rosenberger Hochfrequenztechnik GmbH & Co. KG

RF_35/05.10/6.2